

**Waste Isolation Pilot Plant**  
**Geotechnical Analysis**  
**Report**  
**For**  
**July 2006 – June 2007**

U.S. Department of Energy

March 2008





**Geotechnical Analysis Report for July 2006 – June 2007**  
**DOE/WIPP-08-3177, Vol. 1**

---

This document has been submitted as required to:

Office of Scientific and Technical Information  
P.O. Box 62  
Oak Ridge, TN 37831  
(865) 576-8401

Additional information about this document may be obtained by contacting the WIPP Information Center at 1-800-336-9477. Copies may be obtained by contacting the National Technical Information Service, U.S. Department of Commerce, 5285 Port Royal Road, Springfield, VA 22161.

This page intentionally left blank

## **FOREWORD AND ACKNOWLEDGMENTS**

---

This report contains an assessment of the geotechnical status of the Waste Isolation Pilot Plant (WIPP). During the excavation of the principal underground access and experimental areas, the status was reported quarterly. Since 1987, when the initial construction phase was completed, reports have been published annually. This report presents and analyzes data collected from July 1, 2006, to June 30, 2007.

This Geotechnical Analysis Report (GAR) was written to meet the needs of several audiences. This report satisfies the requirements presented in the WIPP Hazardous Waste Facility Permit<sup>1</sup> (HWFP) and the Certification of Compliance<sup>2</sup> with Subparts B and C, Title 40 *Code of Federal Regulations* (CFR) Part 191, "Environmental Radiation Protection Standards for Management and Disposal of Spent Nuclear Fuel, High-Level and Transuranic Radioactive Wastes." It focuses on the geotechnical performance of the various components of the underground facility, including the shafts, shaft stations, access drifts, and waste disposal areas. The results of investigations of excavation effects and other geotechnical studies are also included.

The report compares the geotechnical performance of the repository to the design criteria. It describes the techniques that were used to acquire the data and the performance history of the instruments. The depth and breadth of the evaluation of the different components of the underground facility vary according to the types and quantities of data available and the complexity of the recorded geotechnical responses. Graphic documentation of data and tabular documentation of instrument history can be provided upon request.

This GAR was prepared by Washington TRU Solutions LLC (WTS) for the U.S. Department of Energy (DOE), Carlsbad Field Office (CBFO), in Carlsbad, New Mexico. Work was supported by the DOE under Contract No. DE-AC29-01AL66444.

---

<sup>1</sup> New Mexico Environment Department (NMED), 2006, "Waste Isolation Pilot Plant Hazardous Waste Facility Permit," NM4890139088-TSDF, Santa Fe, NM

<sup>2</sup> U.S. Environmental Protection Agency, 1998, "Criteria for the Certification and Recertification of the Waste Isolation Pilot Plant's Compliance with the Disposal Regulations: Certification Decision," Federal Register, Vol. 63, No. 95, pp. 27354, May 18, 1998, Washington, DC

This page intentionally left blank

**TABLE OF CONTENTS**

1.0	INTRODUCTION .....	15
1.1	Location and Description .....	15
1.2	Mission.....	18
1.3	Development Status .....	18
1.4	Purpose and Scope of Geomechanical Monitoring Program .....	19
1.4.1	Instrumentation .....	20
1.4.2	Data Acquisition .....	21
1.4.3	Data Evaluation.....	21
1.4.4	Data Errors.....	22
2.0	GEOLOGY.....	23
2.1	Regional Stratigraphy .....	23
2.1.1	Permian.....	23
2.1.1.1	Castile Formation .....	23
2.1.1.2	Salado Formation .....	25
2.1.1.3	Rustler Formation.....	25
2.1.1.4	Dewey Lake Redbeds .....	25
2.1.2	Triassic.....	26
2.1.2.1	Dockum Group .....	26
2.1.3	Quaternary .....	26
2.1.3.1	Gatuña Formation, Mescalero Caliche, and Surficial Sediments .....	26
2.2	Underground Facility Stratigraphy .....	27
2.2.1	Disposal Horizon Stratigraphy of Panels 1, 2, 7, and 8.....	27
2.2.2	Disposal Horizon Stratigraphy of Panels 3, 4, 5, and 6.....	28
2.2.3	Northeast Area Stratigraphy.....	30
3.0	PERFORMANCE OF SHAFTS AND KEYS.....	33
3.1	Salt Shaft .....	33
3.1.1	Shaft Observations.....	35
3.1.2	Instrumentation .....	35
3.2	Waste Shaft .....	38
3.2.1	Shaft Observations.....	40
3.2.2	Instrumentation .....	40
3.3	Exhaust Shaft .....	42
3.3.1	Exhaust Shaft Observations.....	43
3.3.1.1	Video Camera .....	43
3.3.1.2	Shaft Inspection Observations .....	43
3.3.2	Instrumentation .....	52
3.4	Air Intake Shaft .....	54
3.4.1	Shaft Performance .....	55
4.0	PERFORMANCE OF SHAFT STATIONS .....	57
4.1	Salt Shaft Station .....	57
4.1.1	Modifications to Excavation and Ground Control Activities .....	57
4.1.2	Instrumentation .....	57

**Geotechnical Analysis Report for July 2006 – June 2007**  
**DOE/WIPP-08-3177, Vol. 1**

---

4.2	Waste Shaft Station .....	60
4.2.1	Modifications to Excavation and Ground Control Activities .....	60
4.2.2	Instrumentation .....	62
4.3	Air Intake Shaft Station .....	64
4.3.1	Modifications to Excavation and Ground Control Activities .....	64
4.3.2	Instrumentation .....	64
5.0	PERFORMANCE OF ACCESS DRIFTS .....	65
5.1	Modifications to Excavation and Ground Control Activities .....	65
5.2	Instrumentation .....	65
5.2.1	Borehole Extensometers .....	65
5.2.2	Convergence Points .....	65
5.3	Analysis of Convergence Point and Extensometer Data .....	67
5.4	Excavation Performance .....	72
6.0	PERFORMANCE OF WASTE DISPOSAL AREA .....	73
6.1	History .....	73
6.2	Modifications to Excavations and Ground Control Activities .....	74
6.3	Instrumentation .....	74
6.4	Excavation Performance .....	77
6.5	Analysis of Extensometer and Convergence Point Data .....	78
7.0	GEOSCIENCE PROGRAM .....	79
7.1	Borehole Inspections .....	79
7.2	Fracture Mapping .....	83
8.0	SUMMARY .....	85
9.0	REFERENCES .....	87



**Geotechnical Analysis Report for July 2006 – June 2007**  
**DOE/WIPP-08-3177, Vol. 1**

---

**LIST OF TABLES**

---

Table 1-1 – Geomechanical Instrumentation System.....	20
Table 3-1 – Water Removed from the Exhaust Shaft Catch Basin and the Interception Well System .....	50
Table 4-1 – Vertical Closure Rates in the Salt Shaft Station .....	60
Table 4-2 – Summary of Roof Extensometers in Waste Shaft Station .....	62
Table 4-3 – Horizontal Closure Rates in the Waste Shaft Station .....	64
Table 5-1 – Summary of Modifications and Ground Control Activities in the Access Drifts July 1, 2006, through June 30, 2007 .....	66
Table 5-2 – New and Replaced Convergency Points Installed in the .....	66
Table 5-3 – Greater than 10 Percent Increases in Annual Vertical Convergence Rates in the Access Drifts .....	70
Table 6-1 – Summary of Modifications and Ground Control Activities in the Waste Disposal Area from July 1, 2006, to June 30, 2007 .....	74
Table 8-1 – Comparison of Excavation Performance to System Design Requirements.....	86

This page intentionally left blank

**Geotechnical Analysis Report for July 2006 – June 2007**  
**DOE/WIPP-08-3177, Vol. 1**

---

**LIST OF FIGURES**

---

Figure 1-1 – WIPP Location .....	16
Figure 1-2 – Underground Mining and Waste Disposal Configuration as of June 30, 2007 .....	17
Figure 2-1 – Regional Geology.....	24
Figure 2-2 – Repository Level Stratigraphy of Panels 1, 2, 7, and 8 .....	29
Figure 2-3 – Repository Level Stratigraphy of Panels 3, 4, 5, and 6 .....	30
Figure 3-1 – Salt Shaft Stratigraphy .....	34
Figure 3-2 – Salt Shaft Instrumentation (Without Shaft Key).....	36
Figure 3-3 – Salt Shaft Key Instrumentation.....	37
Figure 3-4 – Waste Shaft Stratigraphy .....	39
Figure 3-5 – Waste Shaft Instrumentation (Without Shaft Key).....	41
Figure 3-6 – Waste Shaft Key Instrumentation.....	42
Figure 3-7 – Exhaust Shaft Stratigraphy.....	45
Figure 3-8 – Sample Intake of Exhaust Shaft Air Monitoring System .....	46
Figure 3-9 – Diagram of Exhaust Shaft Fixtures and Seepage Zones (Upper 200 ft) ..	47
Figure 3-10 – Location of Interception Wells and Storage Containers .....	48
Figure 3-11 – Exhaust Shaft Instrumentation (Without Shaft Key) .....	53
Figure 3-12 – Exhaust Shaft Key Instrumentation .....	54
Figure 3-13 – Air Intake Shaft Stratigraphy .....	56
Figure 4-1 – Salt Shaft Station Stratigraphy .....	58
Figure 4-2 – Salt Shaft Station Instrumentation after Roof Beam Excavation .....	59
Figure 4-3 – Waste Shaft Station Stratigraphy .....	61
Figure 4-4 – Waste Shaft Station Instrumentation after Wall Trimming.....	63
Figure 5-1 – Typical Convergence Point Array Configurations Showing Anchor Designations .....	68
Figure 6-1 – Location of Panel 3 Geotechnical Instruments .....	75
Figure 6-2 – Location of Panel 4 Geotechnical Instruments .....	76
Figure 6-3 – Location of Panel 5 Geotechnical Instruments .....	77
Figure 7-1 – Example of Observation Borehole Layout at Lower Horizon .....	81
Figure 7-2 – Example of Observation Borehole Layout at Upper Horizon.....	81
Figure 7-3 – Typical Fracture Patterns at Lower Horizon .....	82
Figure 7-4 – Typical Fracture Patterns at Upper Horizon .....	82

This page intentionally left blank

## **ACRONYMS AND ABBREVIATIONS**

---

ASTM	American Society for Testing and Materials
bp	before present
bsc	below shaft collar
CAO	Carlsbad Area Office
CBFO	Carlsbad Field Office
CFR	Code of Federal Regulations
CH	contact-handled
cm	centimeter(s)
DOE	U.S. Department of Energy
EPA	U.S. Environmental Protection Agency
ft	foot (feet)
GAR	Geotechnical Analysis Report
GIS	geomechanical instrumentation system
HWFP	Hazardous Waste Facility Permit
in	inch(es)
km	kilometer(s)
kPa	kilopascal(s)
kVA	kilovolt ampere(s)
LANL	Los Alamos National Laboratory
lb	pound(s)
m	meter(s)
Ma	million years
MB	marker bed
μin	10 <sup>-6</sup> inch(es)
NMED	New Mexico Environment Department
OMB	orange marker bed
psi	pound(s) per square inch
RH	remote-handled
SPDV	Site and Preliminary Design Validation

**Geotechnical Analysis Report for July 2006 – June 2007**  
**DOE/WIPP-08-3177, Vol. 1**

---

TRU      transuranic  
WIPP     Waste Isolation Pilot Plant  
WTS      Washington TRU Solutions LLC

yr(s)     year(s)

## **1.0 INTRODUCTION**

This Geotechnical Analysis Report (GAR) presents and interprets geotechnical data from the underground excavations at the Waste Isolation Pilot Plant (WIPP). The data, which are obtained as part of a regular monitoring program, are used to characterize conditions, to compare actual performance to the design assumptions, and to evaluate and forecast the performance of the underground excavations.

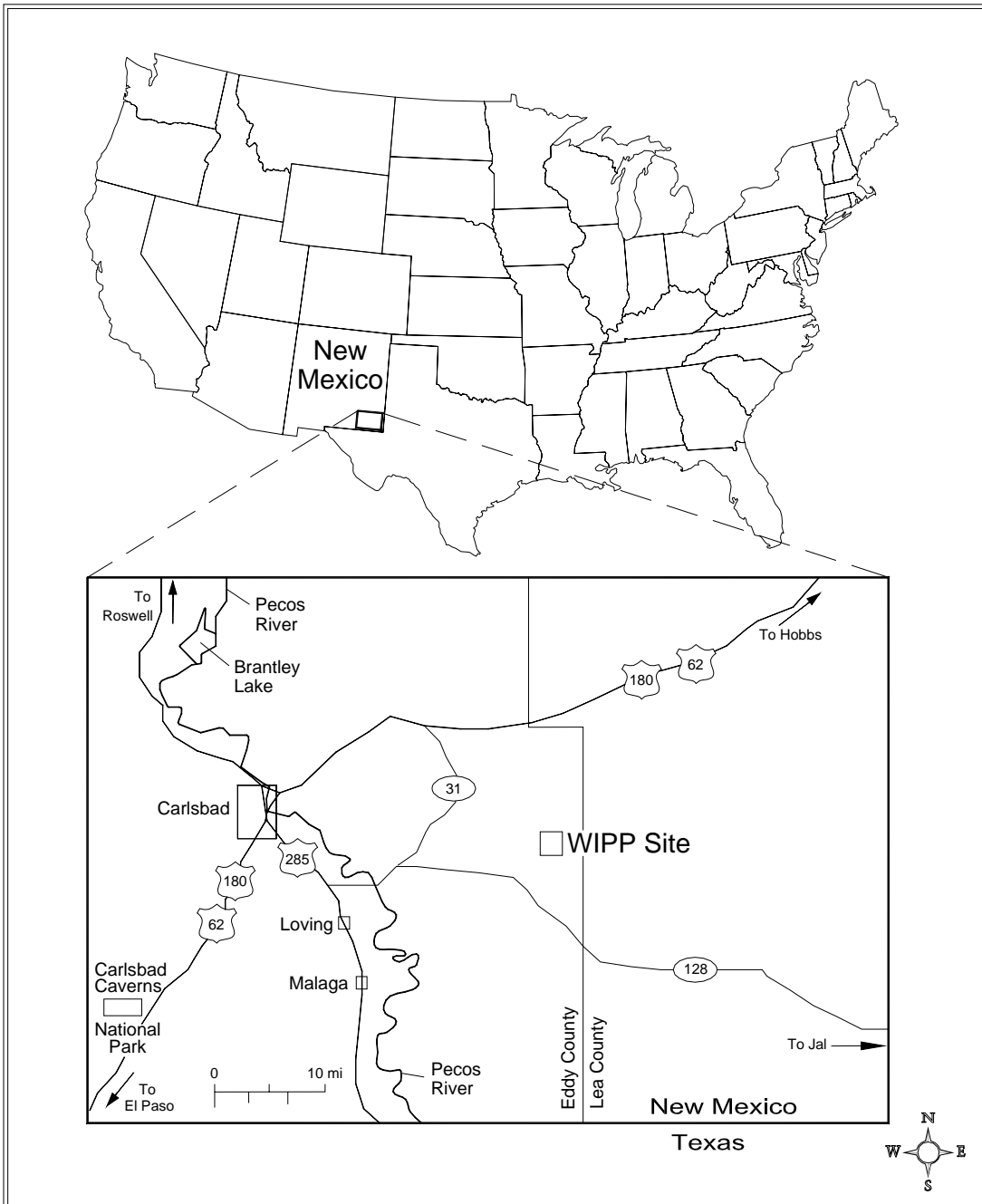
GARs have been available to the public since 1983. During the Site and Preliminary Design Validation (SPDV) Program, the architect/engineer for the project produced these reports quarterly to document the geomechanical performance during and immediately after early excavations of the underground facility. Since completion of the construction phase of the project in 1987, the management and operating contractor for the facility has prepared these reports annually. This report describes the performance and condition of selected areas from July 1, 2006, to June 30, 2007. It is divided into nine chapters.

Chapter 1 provides background information on WIPP, its mission, and the purpose and scope of the geomechanical monitoring program. Chapter 2 describes the local and regional geology of the WIPP site. Chapters 3 and 4 describe the geomechanical instrumentation in the shafts and shaft stations, present the data collected by that instrumentation, and provide interpretation of these data. Chapters 5 and 6 present the results of geomechanical monitoring in the two main portions of the WIPP underground (the access drifts and the waste disposal area). Chapter 7 discusses the results of the Geoscience Program, which include fracture mapping and borehole observations. Chapter 8 summarizes the results of geomechanical monitoring and compares the current excavation performance to the design requirements. Chapter 9 lists references.

### **1.1 Location and Description**

WIPP is located in southeastern New Mexico, 26 miles (42 kilometers [km]) east of Carlsbad (Figure 1-1). The surface facilities were built on the flat to gently rolling terrain that is characteristic of the Los Medaños area. The underground facility is being excavated approximately 2,150 feet (ft) (655 meters [m]) beneath the surface in the Salado Formation. Figure 1-2 shows a plan view of the underground configuration of WIPP as of June 30, 2007.

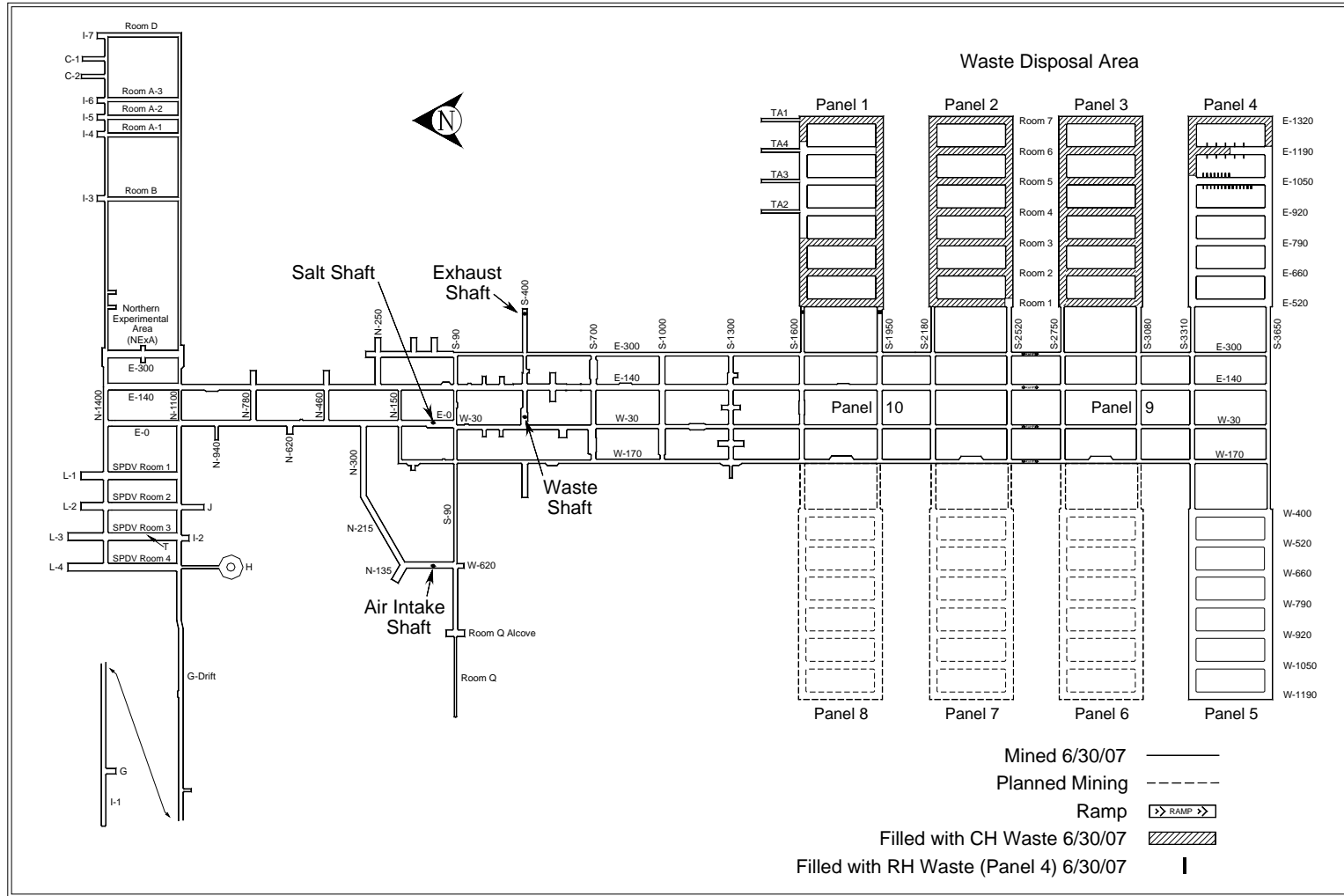
**Geotechnical Analysis Report for July 2006 – June 2007  
DOE/WIPP-08-3177, Vol. 1**



**Figure 1-1 – WIPP Location**



**Geotechnical Analysis Report for July 2006 – June 2007**  
**DOE/WIPP-08-3177, Vol. 1**



**Figure 1-2 – Underground Mining and Waste Disposal Configuration as of June 30, 2007**

## **1.2 Mission**

In 1979 Congress authorized WIPP (Public Law 96-164, National Security and Military Applications of Nuclear Energy Authorization Act of 1980) to provide ". . . a research and development facility to demonstrate the safe disposal of radioactive wastes resulting from the defense activities and programs of the United States exempted from regulation by the Nuclear Regulatory Commission." To fulfill this mission, the U.S. Department of Energy (DOE) constructed a full-scale facility to demonstrate both technical and operational principles of the permanent disposal of transuranic (TRU) and TRU mixed wastes. Technical aspects are those concerned with the design, construction, and performance of the subsurface excavations. Operational aspects refer to the receiving, handling, and emplacement of TRU wastes in the facility. The facility was first used for *in situ* studies and experiments without the use of radioactive waste. WIPP now receives, handles, and permanently disposes of TRU waste and TRU mixed waste.

## **1.3 Development Status**

To fulfill its mission, the DOE developed WIPP in a phased manner. The goal of the SPDV phase, begun in 1980, was to characterize the site and obtain *in situ* geotechnical data from underground excavations to determine whether site characteristics and *in situ* conditions were suitable for permanent disposal. During this phase, the Salt Shaft, a ventilation shaft, a drift to the southernmost extent of the proposed waste disposal area, a four-room experimental panel, and access drifts were excavated. Surface-based geological and hydrological investigations were also conducted. The data obtained from the SPDV investigations were reported in the "Summary of the Results of the Evaluation of the WIPP Site and Preliminary Design Validation Program" (DOE, 1983).

Based upon the favorable results of the SPDV investigations, additional activities were initiated in 1983. These included the construction of surface structures, conversion of the ventilation shaft for use as the Waste Shaft, excavation of the Exhaust Shaft, development of additional access drifts to the waste disposal area, excavation of the Air Intake Shaft, and excavation of additional experimental rooms to support research and development. Geotechnical data acquired during this phase were used to evaluate the performance of the excavations in the context of established design criteria (DOE, 1984). Results of these evaluations were reported in Geotechnical Field Data Reports (DOE, 1985; DOE, 1986a) and were summarized in the Design Validation Final Report (DOE, 1986b).

The Design Validation Final Report concluded that the facility, including waste disposal areas, could be developed and operated to fulfill the long-term mission of WIPP (DOE, 1986b). All available information validated the design of underground openings to safely accommodate the permanent disposal of waste under routine operating conditions.

Panel 1 mining began in 1986 and was completed in 1988. Panel 1 was intended to receive waste for an initial operations demonstration and pilot plant phase that was

scheduled to start in October 1988. However, the demonstration and pilot plant phase was not conducted because waste disposal operations had to wait until permits were acquired.

In October 1996, the DOE submitted to the U.S. Environmental Protection Agency (EPA) a compliance certification application in accordance with 40 CFR Parts 191 and 194, which addressed the long-term (10,000-year) performance criteria for the disposal system. On May 18, 1998, the EPA published the final certification that allowed for the receipt of TRU waste at WIPP. Immediately before this certification, the DOE Carlsbad Area Office (CAO) completed an Operational Readiness Review, which is required by the DOE before the start-up or a process change of any nuclear facility. As a result of the review, the CAO notified the Energy Secretary on April 1, 1998, that WIPP was operationally ready to receive waste. On March 26, 1999, the first shipment of TRU waste was received from Los Alamos National Laboratory (LANL). By the end of June 2007, many additional generator sites had shipped waste to WIPP. The cleanup of several small-quantity generator sites, as well as one large-quantity site (Rocky Flats Environmental Technology Site) is now complete.

Waste disposal in Panels 1, 2, and 3 is complete. These panels contain only CH waste. The first RH waste shipment arrived January 24, 2007. Panel 4 is the first to receive both CH and RH waste. As of June 30, 2007, Room 7 of Panel 4 was filled, and Rooms 5-6 were being filled. Mining of Panel 5 started during this reporting period.

#### **1.4 Purpose and Scope of Geomechanical Monitoring Program**

As specified in the WIPP HWFP (NMED, 2006), the purpose of the geomechanical monitoring program is to obtain *in situ* data to support the continuous assessment of the design for underground facilities.

Specifically, the program provides for:

- Early detection of conditions that could affect operational safety.
- Evaluation of underground openings closure to ensure adequate access while the openings are actively being used.
- Guidance for design modifications and remedial actions.
- Data for interpreting whether the behavior of underground openings stays within the established design criteria.

Data taken by or input into the geomechanical instrumentation system (GIS) are evaluated and reported in this GAR. This annual report fulfills the requirements set forth in Section IV.F.1 and Attachment M2, Section M2-5b(2) of the WIPP HWFP (NMED, 2006), and 40 CFR §191.14, "Assurance Requirements," implemented through the certification criteria, 40 CFR Part 194.

**Geotechnical Analysis Report for July 2006 – June 2007**  
**DOE/WIPP-08-3177, Vol. 1**

---

The Geomechanical Monitoring Program generates the data for four of the compliance monitoring parameters:

- Creep closure and stresses
- Extent of deformation
- Initiation of brittle deformation
- Displacement of deformation features

Convergence measurements and borehole extensometers provide data on salt creep closure induced by rock excavation. Data on the extent of deformation are generated through borehole extensometers and borehole observations. Fracture mapping of the excavation surface, as well as borehole observations, are used to provide data on the initiation of brittle deformation. Displacement of deformation features in the underground facility is monitored by comparing the results of geologic mapping in newly mined areas to the expected stratigraphy.

The GIS provides data that are collected, processed, and stored for analysis. The following subsections briefly describe the major components of the GIS.

#### 1.4.1 Instrumentation

Instrumentation installed for measuring the geomechanical response of the shafts, drifts, and other underground openings includes convergence points, convergence meters, extensometers, rock bolt load cells, pressure cells, strain gauges, piezometers, and joint meters. Table 1-1 lists a summary of the specifications for geomechanical instrumentation.

**Table 1-1 – Geomechanical Instrumentation System**

Instrument Type	Measures	Range <sup>a</sup>	Resolution <sup>a</sup>
Sonic probe borehole extensometer	Cumulative deformation	0–2 in	0.001 in
Convergence point (tape extensometer)	Cumulative deformation	2–50 ft	0.001 in
Wire convergence meter	Cumulative deformation	0–3.5 ft	0.001 in
Embedded strain gauge	Cumulative strain	0–3000 $\mu$ in/in	1 $\mu$ in/in
Spot-welded strain gauge	Cumulative strain	0–2500 $\mu$ in/in	1 $\mu$ in/in
Rock bolt load cell	Load	0–50 tons	40 lb
Earth pressure cell	Pressure	0–1000 psi	1 psi
Piezometer	Fluid pressure	0–500 psi	0.5 psi
Joint meter	Cumulative deformation	0–4 in	0.001 in
Vibrating wire borehole extensometer	Cumulative deformation	0–4 in	0.001 in
Wire borehole extensometer	Cumulative deformation	0–20 in	0.001 in
Linear potentiometric borehole extensometer	Cumulative deformation	0–6 in	0.001 in

<sup>a</sup> Manual readout boxes for the instruments were manufactured to output measurements in English units. Range and resolution measurement units have not been converted to metric units. Measurements from these instruments have been converted for presentation elsewhere in this report.

### **1.4.2 Data Acquisition**

Geomechanical instruments are read either manually, using portable devices, or remotely by electronically polling the stations from the surface in accordance with approved operating procedures. Remotely read instruments are connected to one of the underground data-loggers, and readings are collected by initiating the appropriate polling routine. Upon completion of a verification process, data are transferred to a computer database. Manual readout devices are taken to instrument locations underground. Data are recorded on data sheets and later entered into an electronic database, along with remotely acquired data.

The underground data acquisition system consists of instruments, polling devices, and a communications network. Instruments are connected to polling devices that are installed in electrical enclosures near the instrument locations. Polling devices are connected by a data link to a surface computer.

Whether acquired manually or remotely, geomechanical data are entered into the database files of the GIS data processing system. The data processing system consists of computer programs that are used to enter, reduce, and transfer the data to permanent storage files. Additional routines allow access to the permanent storage files for numerical analysis, tabular reporting, and graphical plotting. Copies of the instrumentation database and data plots are available upon request<sup>3</sup>.

### **1.4.3 Data Evaluation**

Rounding and significant digits are used in the data tables of this document. The reference document is American Society for Testing and Materials (ASTM) document ASTM E 29–06b, "Standard Practice for Using Significant Digits in Test Data to Determine Conformance with Specification."<sup>4</sup>

Closure measurements are acquired manually from convergence point anchors and remotely from convergence meters. Data are presented in plots of closure versus time. Closure rate data are calculated and presented as part of the data analysis.

Borehole extensometers provide relative displacement data from instrumented rods or wires anchored at various depths. Displacements are measured relative to a fixed point. The deepest anchor is fixed in the least disturbed ground and is used as the reference point. Plots show displacement versus time for individual anchors relative to the reference point. Typically, the plots show greater relative movement near the collar, (i.e., the opening of the hole). Displacement rate data for the hole collar relative to the deepest anchor are presented in the data analysis.

---

<sup>3</sup> Instrumentation data and data plots are presented in "Geotechnical Analysis Report for July 2006-June 2007 Supporting Data" (DOE/WIPP-08-3177 Volume 2). The document is available upon request from the National Technical Information Service. See page 3 for details and addresses.

<sup>4</sup> Copyright by ASTM, Reproduction authorized per License Agreement with Washington TRU Solutions LLC.

The annualized closure rate is calculated as follows:

$$\text{rate}(\text{inches} / \text{year}) = (cfi_2 - cfi_1) / (\text{date}_2 - \text{date}_1) \times 365.25 \text{ days} / \text{year}$$

where  $cfi$  = the change from the initial reading (inches)

$cfi_1$  =  $cfi$  reading closest to the beginning of the reporting period

$cfi_2$  =  $cfi$  reading closest to the end of the reporting period

Rock bolt load cells are used to determine bolt support performance. Plots show load versus time for each instrumented bolt.

Earth pressure cells and strain gauges are used to determine the stresses and deformation in and around the shaft liners. Data are depicted in time-based plots.

Piezometers are used to measure the gauge pressure of groundwater and are installed in the shafts at varying elevations to monitor the hydraulic head acting on the shaft liners. Data are plotted as pressure versus time.

Joint meters, installed perpendicular to a crack, monitor the dilation of the crack with time. Data are presented as displacement versus time.

#### **1.4.4 Data Errors**

GIS data are processed through a comprehensive database management system. Whether acquired manually or remotely, GIS data are processed and permanently stored according to approved procedures. On occasion, erroneous readings can occur. There are several possible explanations for erroneous readings, including the following:

- The measuring device was misread.
- The reading was recorded incorrectly.
- The measuring device was not functioning within specifications.

When a reading is believed to be erroneous, an immediate evaluation of the suspect reading is performed, and a second reading is collected. If the second reading falls in line with the instrument trend, the first reading is discarded and the second reading is entered in the database. If the second reading and subsequent readings remain out of the instrument trend, the ground conditions in the vicinity of the instrument are assessed to determine the reason for the discrepancy. In addition, the reading frequency may be increased. This process to correct erroneous readings is documented and filed for future reference.

## **2.0 GEOLOGY**

This chapter provides a summary of the stratigraphy of the WIPP region and the site. Readers desiring further geologic information may consult the "Geological Characterization Report, WIPP Site, Southeastern New Mexico" (Powers et al., 1978). This report was developed as a source document on the geology of the WIPP site for individuals, groups, or agencies seeking basic information on geologic history, hydrology, geochemistry, or detailed information, such as physical and chemical properties of repository rocks. A more recent survey of WIPP stratigraphy is included in Holt and Powers (1990).

### **2.1 Regional Stratigraphy**

The stratigraphy in the vicinity of the WIPP site includes rocks of Permian (295 to 250 million years [Ma] before present [bp]), Triassic (250 to 203 Ma), and Quaternary (1.75 Ma to present) ages. The descriptions of formations provided in this section are given in order of deposition (oldest to youngest), beginning with the Castile Formation (Figure 2-1).

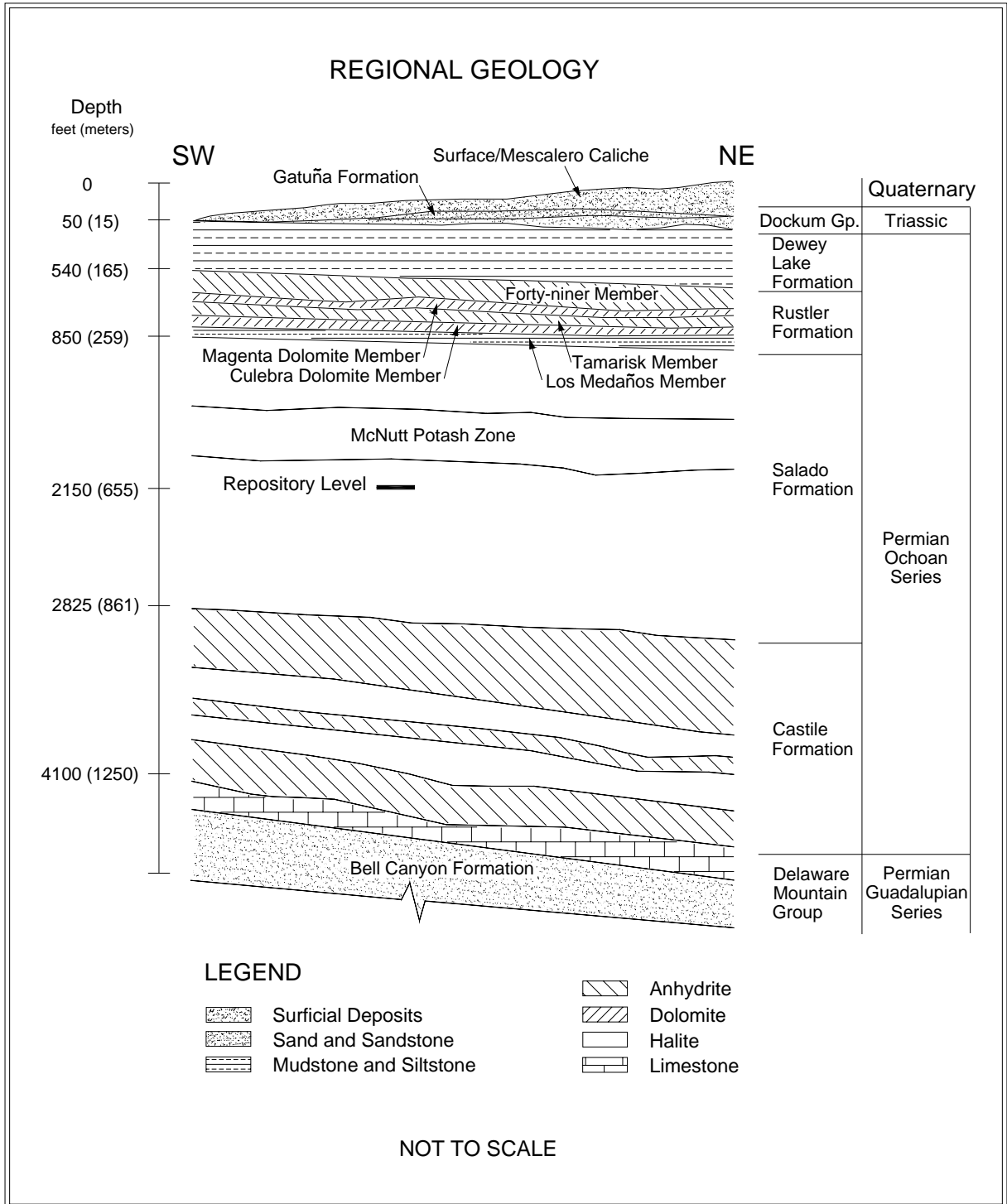
#### **2.1.1 Permian**

The Permian system in southwestern North America is divided into four series. The last of these, the Ochoan Series, contains the host rock in which the WIPP repository is located. The Ochoan Series is of mostly marine origin and consists of four formations: three evaporite formations (the Castile, the Salado, and the Rustler) and one redbeds formation (the Dewey Lake). The Ochoan evaporites overlie marine limestones and sandstones of the Guadalupian Series (Delaware Mountain Group). The younger redbeds represent a transition from the lower evaporite deposition to fluvial deposition on a broad, low-relief, fluvial plain. The Permian rocks are overlain by fluvial deposits of the Triassic and Quaternary periods.

##### **2.1.1.1 Castile Formation**

The Castile Formation, lowermost of the four Ochoan formations, is approximately 1,250 ft (380 m) thick in the WIPP vicinity. Lithologically, the Castile is the least complex of the evaporite formations and is composed chiefly of interbedded anhydrite and halite, with limestone present in minor amounts.

**Geotechnical Analysis Report for July 2006 – June 2007  
DOE/WIPP-08-3177, Vol. 1**



**Figure 2-1 – Regional Geology**



### **2.1.1.2 Salado Formation**

The Salado Formation comprises nearly 2,000 ft (610 m) of evaporites, primarily halite. The formation is subdivided into three informal members: the unnamed lower member, the McNutt potash zone, and the unnamed upper member. Each member contains similar amounts of halite, anhydrite, and polyhalite and is differentiated on the basis of soluble potassium- and magnesium-bearing minerals. The WIPP disposal horizon is located within the unnamed lower member, 2,150 ft (655 m) below the surface.

### **2.1.1.3 Rustler Formation**

The Rustler Formation is subdivided into five members, starting from its base: the Los Medaños Member, the Culebra Dolomite Member, the Tamarisk Member, the Magenta Dolomite Member, and the Forty-niner Member.

In the vicinity of the WIPP site, the Rustler is approximately 310 ft (95 m) thick and thickens to the east. The lower portion (Los Medaños Member) contains primarily fine sandstone to mudstone with lesser amounts of anhydrite, polyhalite, and halite. Bedded and burrowed siliciclastic sedimentary rocks with cross-bedding and fossil remains signify the transition from the strongly evaporitic environments of the Salado to the brackish lagoonal environments of the Rustler (Holt and Powers, 1990).

The upper portion of the Rustler contains interbeds of anhydrite, dolomite, and mudstone. The Culebra Dolomite member is generally brown, finely crystalline, and locally argillaceous. The Culebra contains rare to abundant vugs with variable gypsum and anhydrite filling and is the most transmissive hydrologic unit within the Rustler. The Tamarisk Member consists of lower and upper sulfate units separated by a unit that varies laterally from mudstone to mainly halite. The Magenta Dolomite Member is a gypsiferous dolomite with abundant primary sedimentary structures and well-developed algal features. The Forty-niner Member consists of lower and upper sulfate units separated by a mudstone that displays sedimentary features and bedding. East of the site area, halite correlates with the mudstone. The Culebra and Magenta Dolomite members are persistent and serve as important marker units.

### **2.1.1.4 Dewey Lake Redbeds**

The Dewey Lake Redbeds is the uppermost of the Ochoan Series formations. Within the series, the Dewey Lake represents a transition from the lower marine evaporite deposition to fluvial deposition on a broad, low-relief, fluvial plain. The redbeds, approximately 475 ft (145 m) thick, consist of predominantly reddish-brown interbedded fine-grained sandstone, siltstone, and claystone. The formation is differentiated from other formations by its lithology and distinctive color (both of which are remarkably uniform), and sedimentary structures, including horizontal- and cross-laminae and ripple marks. The redbeds also contain locally abundant greenish-gray reduction spots and gypsum-filled fractures. The formation thickens from west to east due to eastward dips and erosion to the west.

## **2.1.2 Triassic**

The only Triassic rocks present in the WIPP region belong to the Dockum Group.

### **2.1.2.1 Dockum Group**

The Dockum Group consists of fine-grained floodplain sediments and coarse alluvial debris of Triassic age. At the WIPP site, the Dockum Group pinches out near the center of the site and thickens eastward as an erosional wedge. Local subdivisions of the Dockum Group are the Santa Rosa Sandstone and the Chinle Formation; however, only the Santa Rosa occurs in the vicinity of the site. The Santa Rosa consists primarily of poorly sorted sandstone with conglomerate lenses and thin mudstone partings and contains impressions and remnants of fossils. These rocks have more variegated hues than the underlying uniformly colored Dewey Lake.

## **2.1.3 Quaternary**

Quaternary Period deposits include the Gatuña Formation, Mescalero Caliche, and surficial sediments.

### **2.1.3.1 Gatuña Formation, Mescalero Caliche, and Surficial Sediments**

The Gatuña Formation (ranging in age from approximately 1.3 Ma to 600,000 years bp) (Powers and Holt, 1993) is a stream-laid deposit overlying the Dockum Group in the WIPP vicinity. At the site center, the formation consists of approximately 13 ft (4 m) of poorly consolidated sand, gravel, and silty clay. The Gatuña Formation is light red and mottled with dark stains. The unit contains abundant calcium carbonate, but is poorly cemented. Sedimentary structures are abundant (Powers and Holt, 1993, 1995).

The Mescalero Caliche (approximately 500,000 years bp) is approximately 4 ft (1.2 m) thick in the WIPP vicinity. The Mescalero is a hard, resistant soil horizon that lies beneath a cover of wind-blown sand. The horizon is petrocalcic, or very strongly cemented with calcium carbonate. Petrocalcic horizons form slowly beneath a stable landscape at the average depth of infiltration of soil moisture and indicate stability and integrity of the land surface. Many of the surface buildings at WIPP are founded on top of the Mescalero Caliche.

Surficial sediments include sandy soils developed from eolian material and active dune areas. The Berino Series (a soil type) covers about 50 percent of the site and consists of deep sandy soils that developed from wind-worked material of mixed origin. Based on sample analyses, the Berino soil from the WIPP site formed 330,000 ± 75,000 years bp.

## **2.2 Underground Facility Stratigraphy**

The WIPP disposal horizon lies near the midpoint of the Salado Formation. The Salado was deposited in a shallow saline lagoon environment, which progressed through numerous inundation and desiccation cycles that are reflected in the formation. An "ideal" cycle progresses upward as follows: a basal layer consisting predominantly of claystone, followed by a layer of sulfate, which is in turn followed by a layer of halite. The entire sequence is capped by a bed of argillaceous (clay-rich) halite accumulated during a period of mainly subaerial exposure.

A regional system used for numbering the more significant sulfate beds within the Salado designates these beds as marker beds (MBs), counted from MB100 near the top of the formation to MB144 near the base. The repository is located between MB138 and MB139 (Figure 2-2) within a sequence of laterally continuous depositional cycles as described above. Within this sequence, layers of clay and anhydrite that are locally designated (as shown) can have a significant impact on the geomechanical performance of the excavations. Clay layers provide surfaces along which slip and separation can occur, whereas anhydrite acts as a brittle unit that does not deform plastically.

In the vicinity of the WIPP, the stratigraphy is fairly continuous and uniform. Beds generally dip towards the south-southeast at a slope of approximately 3 percent.

### **2.2.1 Disposal Horizon Stratigraphy of Panels 1, 2, 7, and 8**

This disposal horizon contains Panels 1, 2, 7, and 8, all the shaft areas, the shop areas, the SPDV areas (which are now closed), and all the access drifts to S-2620 (the four main entries that extend south rise in a ramp that starts at S-2620 and ends at S-2740). Panels 7 and 8 have not yet been excavated.

Most underground excavations are located within this disposal horizon (Figure 2-2). In it, the Orange Marker Bed (OMB) lies near the middle of the rib (i.e., the excavation wall). The OMB is a laterally consistent unit of moderate to light reddish-orange translucent halite about 6 inches (in) (15 centimeters [cm]) thick that is used as a point of reference during excavation.

MB139 lies approximately 5 ft (1.5 m) below the excavation floor. MB139 is a 20-to-32 in (50-to-80 cm) thick layer of polyhalitic anhydrite. The top of the anhydrite undulates up to 15 in (38 cm), while the bottom is sub-horizontal and is underlain by clay "E". Above MB139 is a unit of halite that terminates at the base of the OMB. Within this unit, polyhalite is locally abundant and decreases upward, while argillaceous material increases upward.

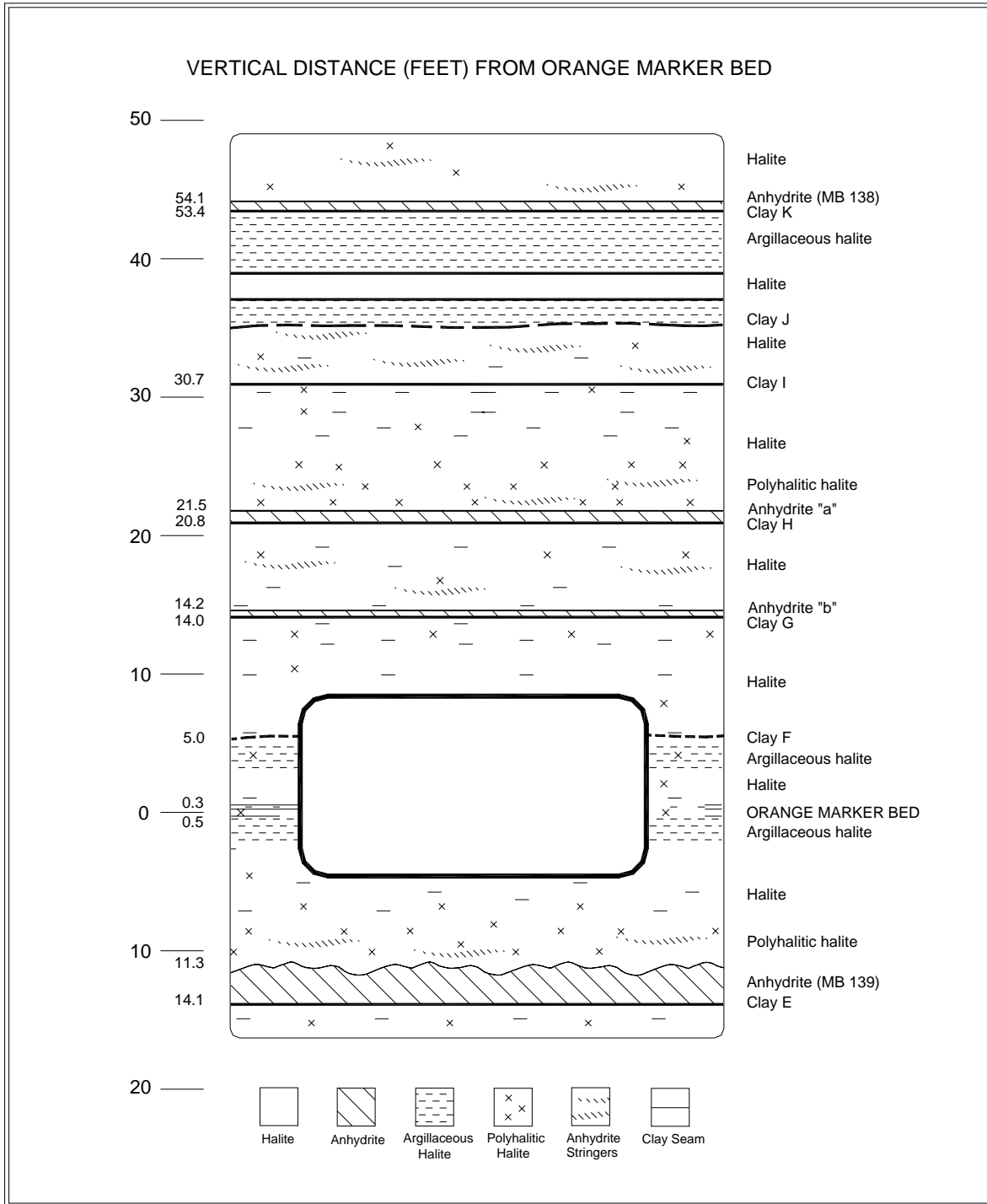
Above the OMB, a thin band of argillaceous halite gives way to a thick sequence of clear halite that becomes increasingly argillaceous upward and is capped by clay "F". Clay "F" occurs as a thin layer occasionally interrupted by partings and breaks and is readily visible in the upper ribs of disposal horizon excavations. Above clay "F", another sequence of halite begins that, as in lower sequences, becomes increasingly

argillaceous upward. This sequence terminates at the clay "G"/Anhydrite "b" interface, approximately 6.5 ft (2 m) above the roof of most disposal horizon excavations, forming a roof beam that typically acts as a structural unit. The roof of some disposal horizon excavations (e.g., the E-140 drift between S-1000 and 1950) has been excavated to the upper contact of Anhydrite "b". In this case, a roof beam is formed by the next depositional sequence beginning with Anhydrite "b" and progressing upward to the clay "H"/Anhydrite "a" interface, approximately 6.5 ft (2 m) above the upper contact of Anhydrite "b".

### **2.2.2 Disposal Horizon Stratigraphy of Panels 3, 4, 5, and 6**

Field observations and computer modeling indicated that moving the disposal horizon stratigraphically upwards (so that the roof was located at clay "G") would improve long-term ground conditions and provide a more stable roof configuration without significantly impacting repository performance. In 2000, the decision was made to implement this change by moving the mining horizon up approximately six feet. Subsequently, in 2000 and 2001, ramps were mined in the W-170, W-30, E-140, and E-300 drifts between S-2620 and S-2750 (Figure 1-2). As a result, the disposal horizon for Panels 3, 4, 5, and 6, and the associated connecting drifts, lies above the horizon for the other panels (Figure 2-3). Panel 5 is being excavated. Panel 6 has not yet been excavated.

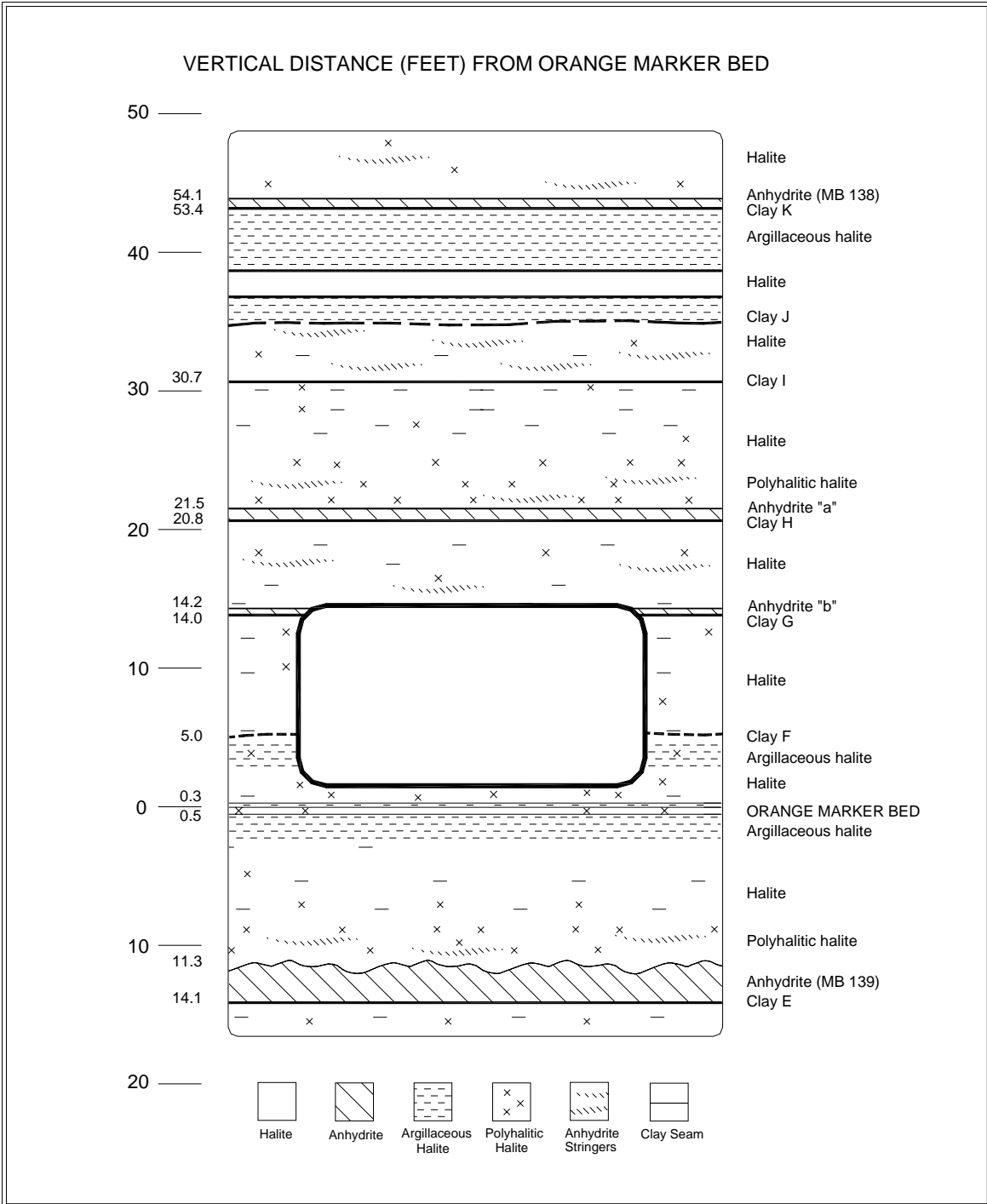
**Geotechnical Analysis Report for July 2006 – June 2007**  
**DOE/WIPP-08-3177, Vol. 1**



**Figure 2-2 – Repository Level Stratigraphy of Panels 1, 2, 7, and 8**

In this horizon (see Figure 2-3), the OMB lies at or below the floor. MB139 lies about 12 ft (3.7 m) below the floor. The roof is immediately above Anhydrite "b". Clay "G"/ Anhydrite "b" is used as the mining reference during excavation of this disposal horizon.

**Geotechnical Analysis Report for July 2006 – June 2007**  
**DOE/WIPP-08-3177, Vol. 1**



**Figure 2-3 – Repository Level Stratigraphy of Panels 3, 4, 5, and 6**

**2.2.3 Northeast Area Stratigraphy**

All of the Northeast Area, a former experimental area, is now deactivated and closed to access. These excavations lie at a higher stratigraphic level than the disposal excavations. Floors are at Anhydrite "b". As in the lower units, the halite intervals between the clay seams/anhydrite beds contain relatively pure halite that becomes

**Geotechnical Analysis Report for July 2006 – June 2007**  
**DOE/WIPP-08-3177, Vol. 1**

---

increasingly argillaceous upward. Above clay "I", two more halite intervals complete the underground facility stratigraphy. Clay "J", at the top of the first of these intervals, may occur as a distinct seam or merely an argillaceous zone. Clay "K" tops the second interval and is overlain by anhydrite MB138.

This page intentionally left blank



### **3.0 PERFORMANCE OF SHAFTS AND KEYS**

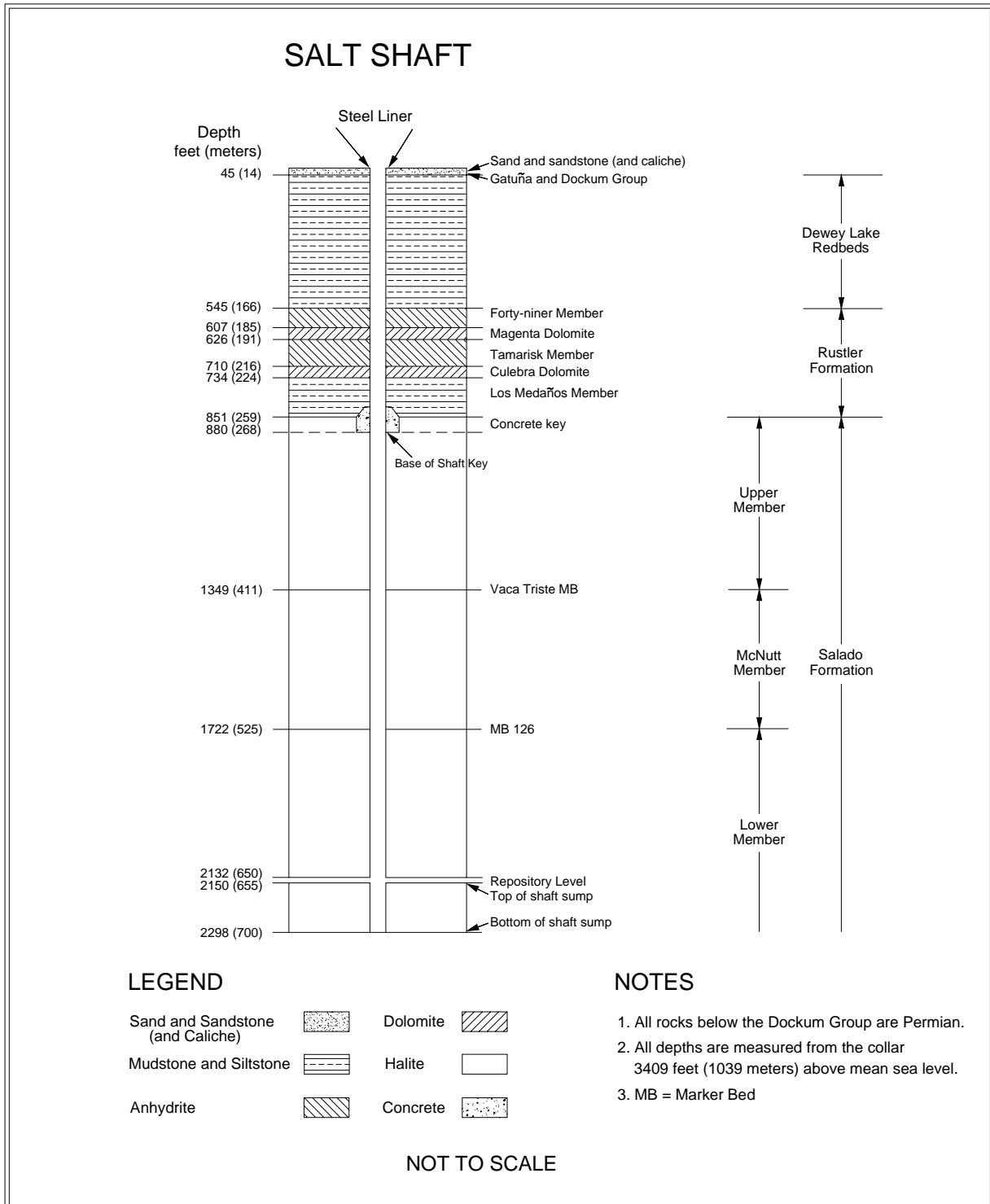
Four shafts connect the surface with the WIPP underground. They are the Salt Shaft, which is used primarily for removing excavated salt from the underground and is used for transporting personnel and material; the Waste Shaft, which is used primarily for transporting TRU waste to the underground and for transporting personnel and materials; the Exhaust Shaft, which is used to exhaust the ventilation air from the underground; and the Air Intake Shaft, which is the primary source of fresh air ventilation to the underground. This chapter describes the geomechanical performance of these shafts.

Although through the years much of the instrumentation installed in the shafts has failed, there are no plans to replace it. The project has a good understanding of the expected movements in the shafts. Monitoring results up to the point of instrument failure did not indicate unusual shaft movements or displacements. Continued periodic visual inspections confirm the expected shaft performance and provide necessary observations to evaluate shaft performance. Replacement of failed instrumentation will not provide significant additional information.

#### **3.1 Salt Shaft**

The first construction activity undertaken during the SPDV Program was the excavation of the Exploratory Shaft. This shaft was subsequently referred to as the Construction and Salt Shaft and is currently designated the Salt Shaft (see Figure 1-2). The shaft was drilled from July 4 to October 24, 1981, and geologically mapped in the spring of 1982 (DOE, 1983). Figure 3-1 presents the stratigraphy in the Salt Shaft.

The Salt Shaft is lined from the surface to 846 ft (258 m) with steel casing having an inside diameter of 10 ft (3-m). The thickness of the steel liner (including external stiffener rings) increases from 0.62 in (1.6 cm) at the top to 1.5 in (3.8 cm) at the key. Cement grout was placed between the liner and rock face. The 10-ft (3-m) diameter extends through the concrete shaft key to 880 ft (268 m). The shaft key is a 37.5 ft (11.4-m) long, reinforced-concrete structure that begins 3.5 ft (1.07 m) above the bottom of the steel liner. From the key to the bottom at 2,298 ft (700 m), the shaft has a nominal diameter of 12 ft (4 m).



**Figure 3-1 – Salt Shaft Stratigraphy**

Wire mesh anchored by rock bolts is installed in sections of the lower shaft as a safety screen to contain rock fragments that may become detached. The shaft extends approximately 140 ft (43 m) below the repository horizon in order to accommodate the skip loading equipment and to act as a sump.

### **3.1.1 Shaft Observations**

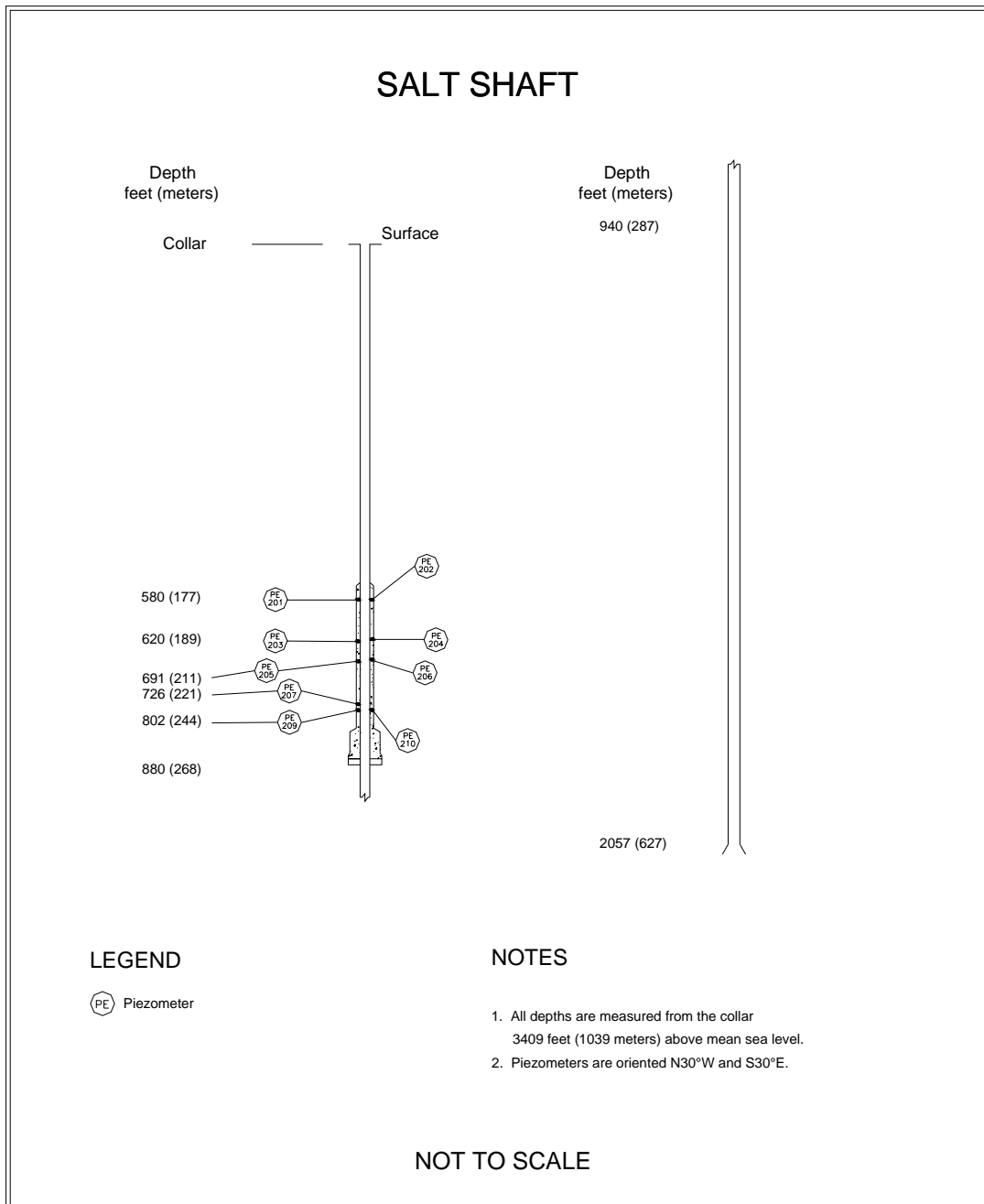
Underground operations personnel conduct weekly visual shaft inspections. These inspections are performed principally to assess the condition of the hoisting and mechanical systems, but they also include examining the shaft walls for water seepage, loose rock, or sloughing. Visual shaft inspections during this reporting period found that the Salt Shaft was in satisfactory condition. Only routine ground control activities were required.

### **3.1.2 Instrumentation**

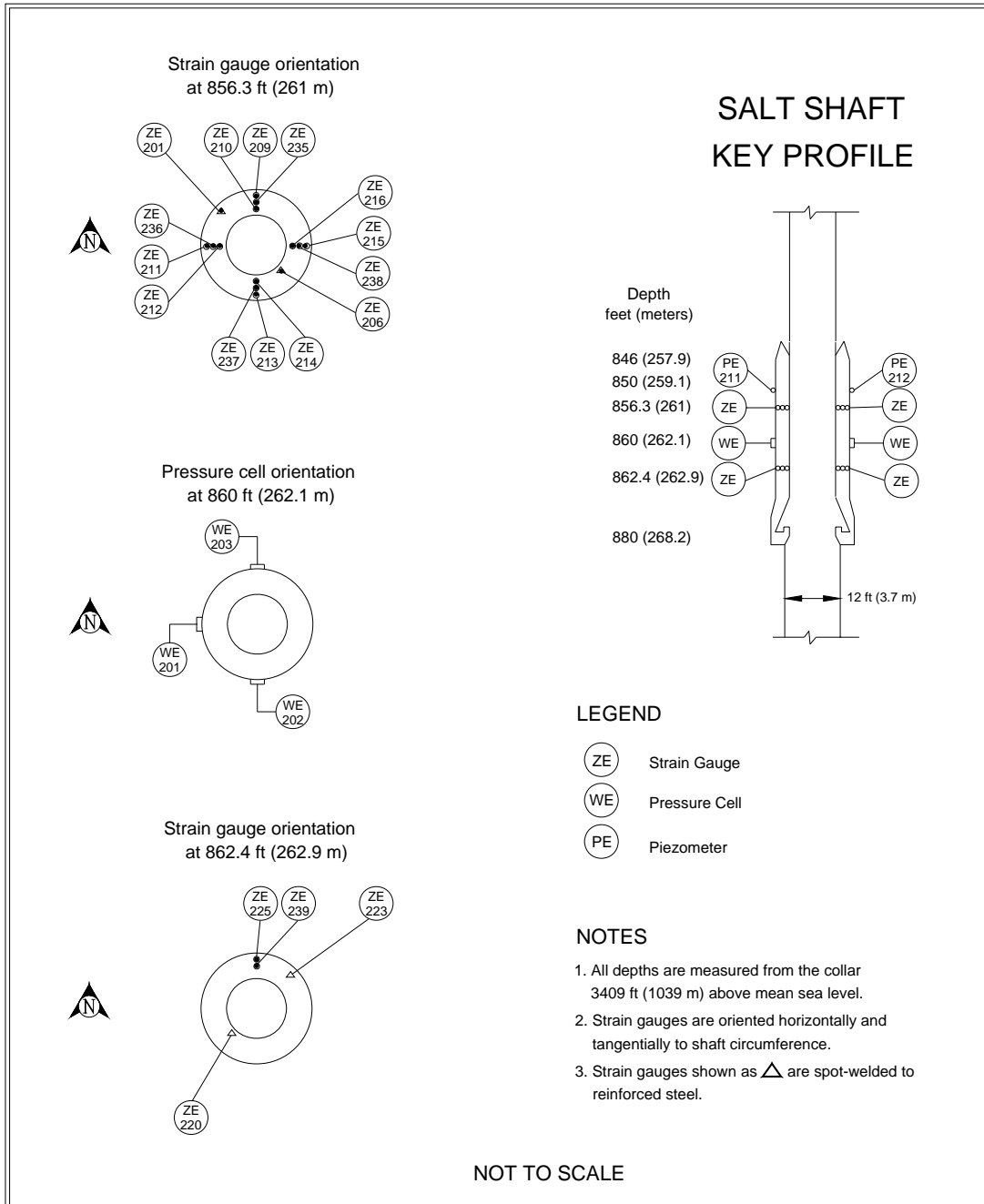
Geomechanical instruments (radial convergence points, extensometers, and piezometers) were installed at various levels in the Salt Shaft from April through July of 1982 (Figure 3-2). In the shaft key, instruments included strain gauges, pressure cells, and piezometers. Radial convergence points were installed prior to outfitting. Upon completion of shaft outfitting, no more readings were taken. Figures 3-2 and 3-3 show the instrument locations.

Eleven of the 12 piezometers continue to provide data. The fluid pressures recorded at the end of this reporting period range from approximately 70 pounds per square inch (psi) (483 kilopascals [kPa]) at the 802-ft (244-m) level in the Los Medaños Member to 177 psi (1,220 kPa) at the 691-ft (211-m) level in the Magenta Dolomite Member. The recorded pressures for this reporting period are generally consistent with the readings from the previous reporting period. The fluid pressure on the shaft liner will continue to be monitored on a regular basis.

Four earth pressure cells were installed in the key section of the Salt Shaft during concrete emplacement at the 860-ft (262-m) level. These instruments measure the normal stress between the concrete key and the Salado Formation as salt creep loads up the key structure. Three of the four earth pressure cells continue to provide data. These instruments have indicated essentially no contact pressure since their installation (readings resemble instrument drift at a zero pressure). The contact pressures recorded by the instruments for this reporting period ranged from -22 to 5 psi (-152 to 34 kPa).



**Figure 3-2 – Salt Shaft Instrumentation (Without Shaft Key)**



**Figure 3-3 – Salt Shaft Key Instrumentation**

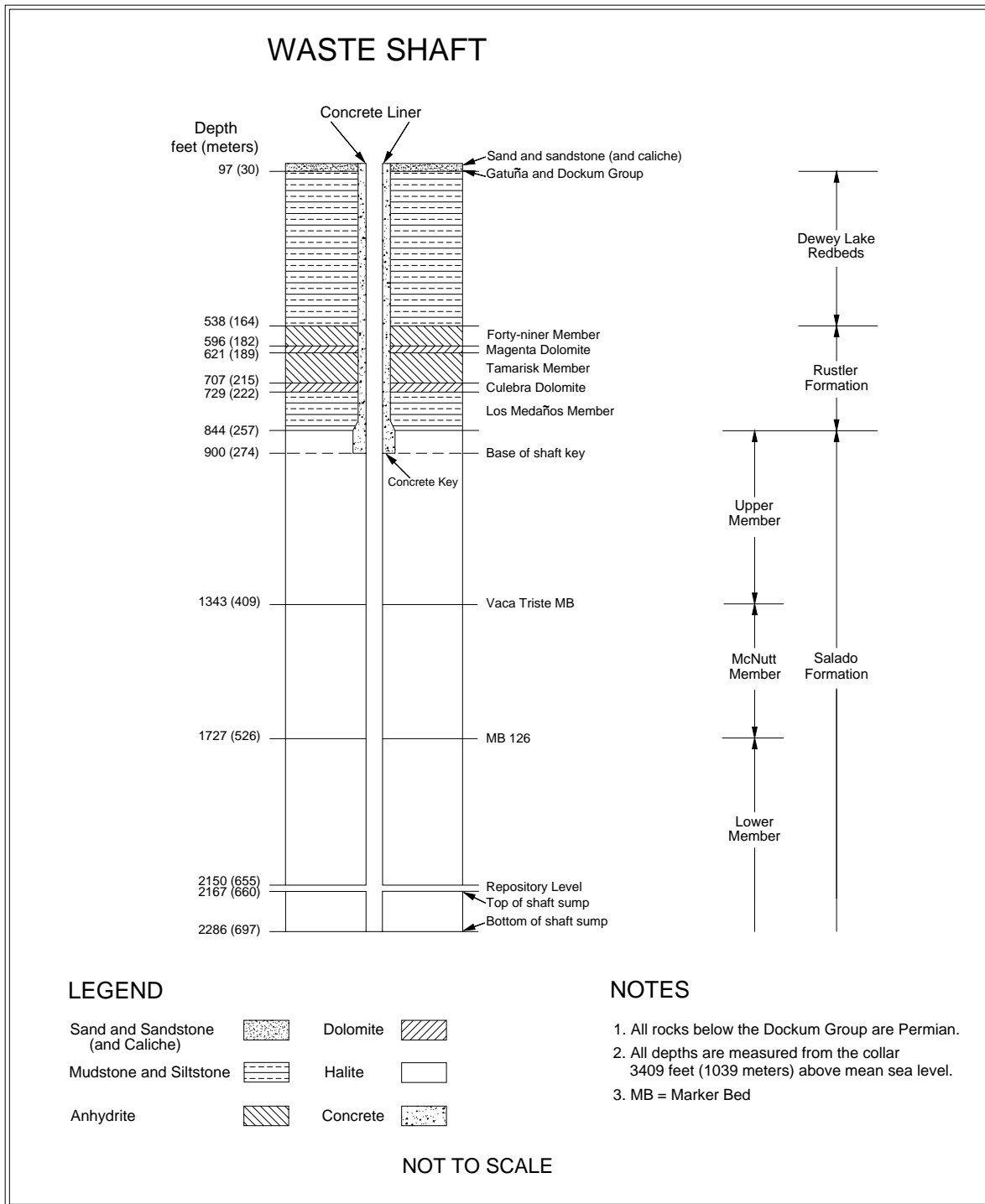
Sixteen spot-welded and twenty-four embedment strain gauges were installed on and in the shaft key concrete at both the 856.3-ft (261-m) level and at the 862.4-ft (263-m) level. Four spot-welded strain gauges are still functioning at these levels. Maximum strains at the 856.3-ft (261-m) level were 672 and 739 microstrain. Strains at the 862.4-ft (262.9-m) level were 620 and 856 microstrain. The strains from the 12 embedment strain gauges at the 856.3-ft (261-m) level ranged from -826 to 999 microstrain. The strains from the two embedment strain gauges at the 862.4-ft (262.9-m) level were 217 to 358 microstrain. The strains recorded by the spot-welded strain gauges and the embedment strain gauges during this reporting period are very similar to the strains recorded by these instruments at the end of the previous reporting period.

### **3.2 Waste Shaft**

As part of the SPDV Program, a 6-ft (2-m) diameter ventilation shaft, now referred to as the Waste Shaft, was excavated from December 1981 through February 1982 (see Figure 1-2). This shaft, in combination with the Salt Shaft, provided a two-shaft underground air circulation system. From October 11, 1983, to June 11, 1984, the shaft was enlarged to a diameter of 20 to 23 ft (6 to 7 m) and lined above the key. Stratigraphic mapping (Figure 3-4) was conducted during shaft enlargement from December 9, 1983, to June 5, 1984 (Holt and Powers, 1984).

The Waste Shaft is lined with non-reinforced concrete having a 19 ft (6 m) inside diameter from the surface to the top of the key at 837 ft (255 m). Liner thickness increases from 10 in (25 cm) at the surface to 20 in (51 cm) at the key. The key is 63 ft (19 m) long and 4.25 ft (1.3 m) thick and is constructed of reinforced concrete. The bottom of the key is 900 ft (274 m) below the surface. The diameter of the shaft is 20 ft (6 m) at the bottom of the key and increases to 23 ft (7 m) just above the shaft station. The shaft below the key is lined with wire mesh anchored by rock bolts. The diameter of 23 ft (7 m) extends to a depth of approximately 2,286 ft (697 m), with the shaft sump comprising the lower 119 ft (36 m) of that interval.

**Geotechnical Analysis Report for July 2006 – June 2007**  
**DOE/WIPP-08-3177, Vol. 1**



**Figure 3-4 – Waste Shaft Stratigraphy**

### **3.2.1 Shaft Observations**

Underground operations personnel conduct weekly visual shaft inspections, principally to assess the condition of the hoisting and mechanical systems, but also include observation of the shaft walls for water seepage, loose rock, or sloughing. The visual shaft inspections found that the Waste Shaft was in satisfactory condition. No ground control activities other than routine maintenance were required.

### **3.2.2 Instrumentation**

Radial convergence points, extensometers, piezometers, and earth pressure cells were installed in the Waste Shaft between August 27 and September 10, 1984. Radial convergence points were installed prior to the outfitting. Upon completion of shaft outfitting, no more radial convergence readings were taken. Figures 3-5 and 3-6 show the instrument locations.

Nine multiposition borehole extensometers were installed in arrays 1,071 ft (326 m), 1,566 ft (477 m), and 2,059 ft (628 m) below the surface as shown in Figure 3-5. Each array consists of three extensometers. Currently, six out of nine extensometers remain functional; however, no data have been collected during this reporting period due to the malfunction of the data-logger. Since the type of extensometers installed in the shaft over 22-years ago are no longer manufactured, remote data acquisition equipment for these extensometers are also unavailable, although a method of acquiring the extensometer data (which would use an available manual electronic readout), is being considered. Since the manual readout is not designed to read instruments over the distances required in the shaft, interfacing and excitation issues will need to be resolved.

Twelve piezometers were installed in the lined section of the Waste Shaft on September 7 and 8, 1984, to monitor fluid pressure behind the shaft liner and the key section in the shaft. Data continue to be received from 10 piezometers. The maximum recorded fluid pressure during this reporting period is 141 psi (972 kPa) at the 717-ft (219-m) level. The pressure readings this reporting period were consistent with the readings from the previous reporting period with a mean change in pressures of less than 2 psi (14 kPa).

Four earth pressure cells were installed in the key section of the Waste Shaft during concrete emplacement between March 23 and April 3, 1984. Three are still working. These instruments measure the normal stress between the concrete key and the Salado Formation as salt creep loads the key structure. The contact pressures recorded by the instruments for this reporting period ranged from 76 to 107 psi (524 to 738 kPa).



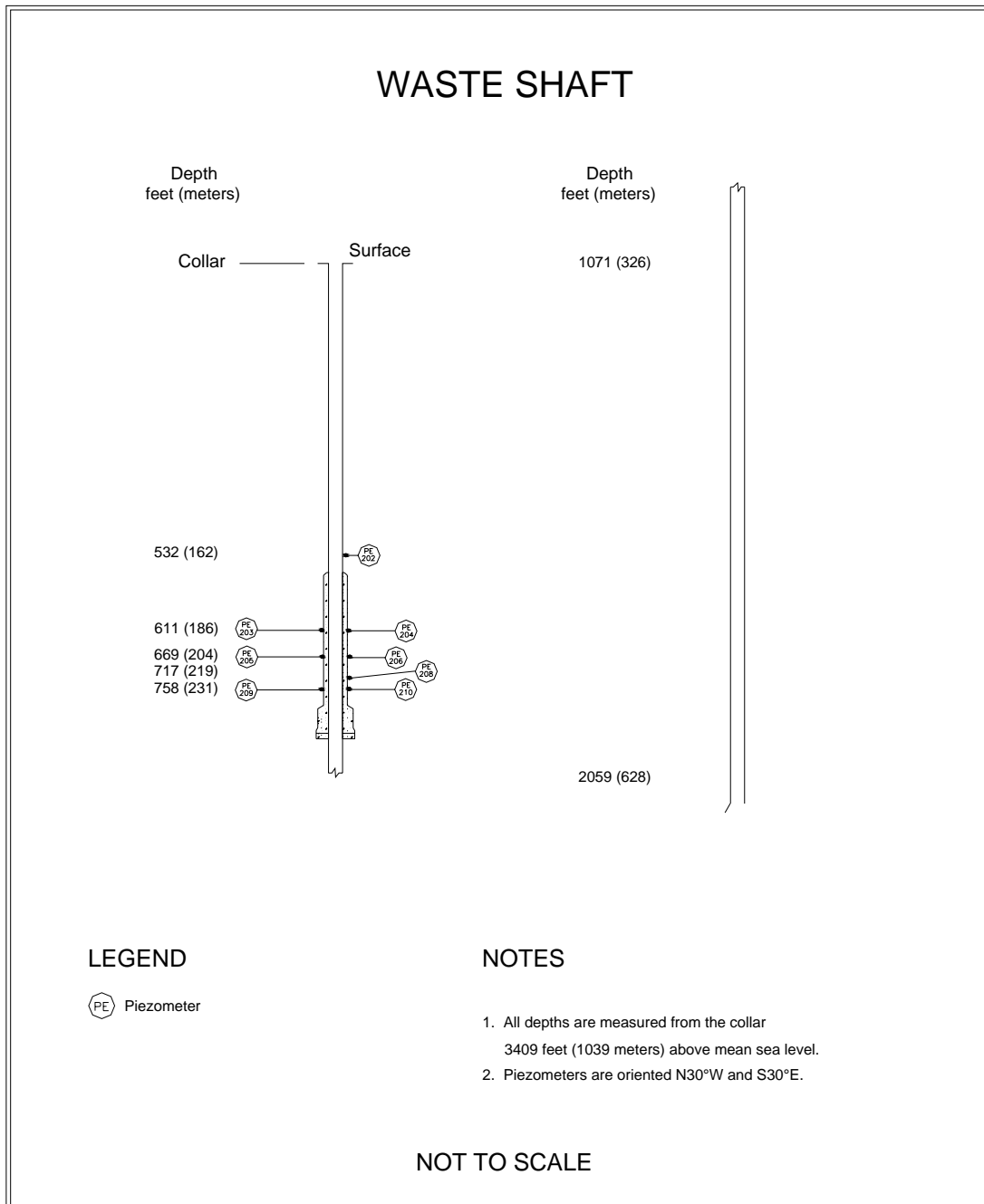
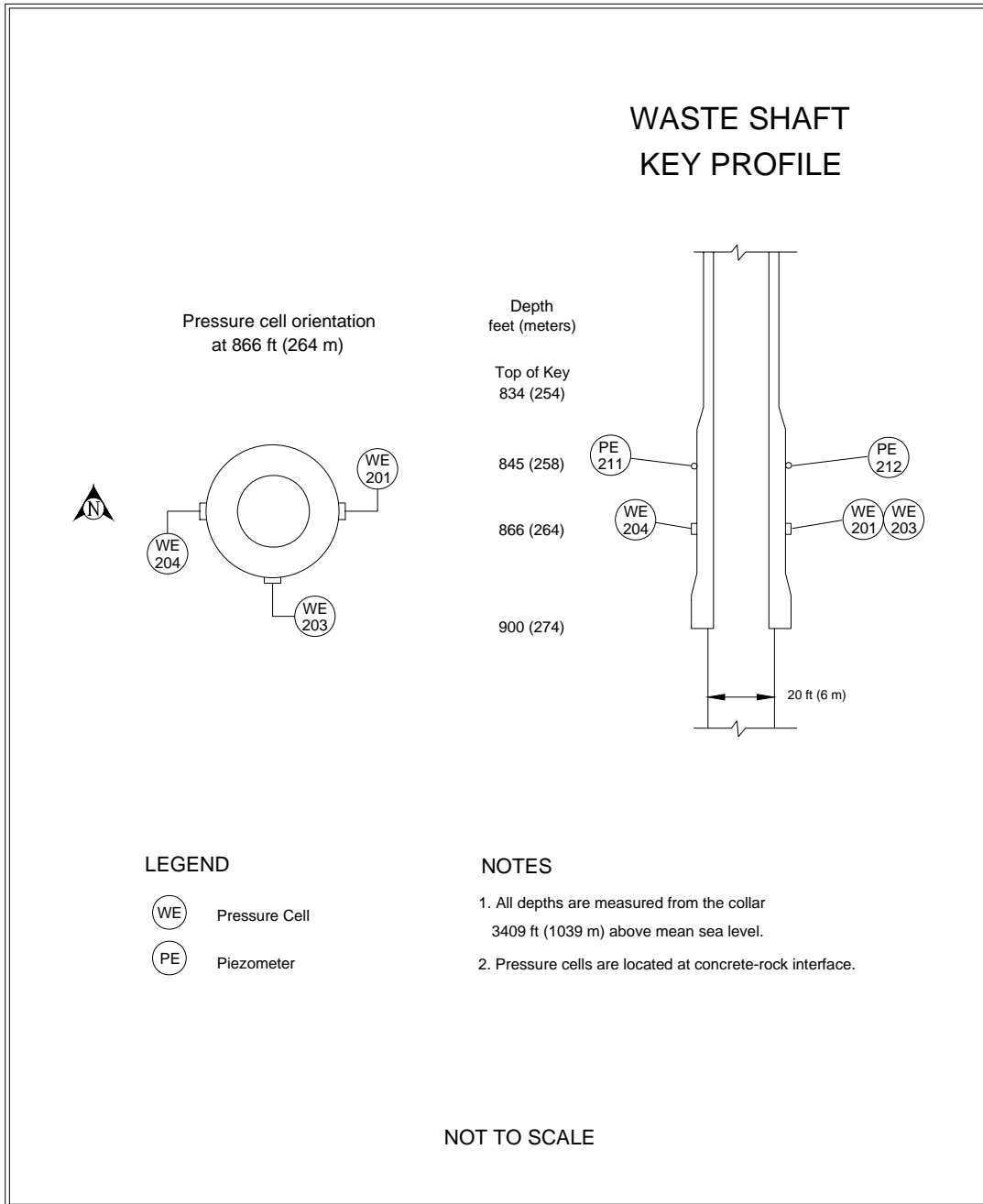


Figure 3-5 – Waste Shaft Instrumentation (Without Shaft Key)



**Figure 3-6 – Waste Shaft Key Instrumentation**

### 3.3 Exhaust Shaft

The Exhaust Shaft was drilled from September 22, 1983, to November 29, 1984, to establish a route from the underground to the surface for exhaust air (Figure 1-2). Stratigraphic mapping was conducted from July 16, 1984, to January 18, 1985 (DOE, 1986c). Figure 3-7 illustrates the Exhaust Shaft stratigraphy.

The Exhaust Shaft is lined with non-reinforced concrete from the surface to the top of the shaft key at 844 ft (257 m). The liner thickness increases from 10 to 16 in (25 to 41 cm) over that interval. The key is 63 ft (19 m) long and 3.5 ft (1 m) thick. The shaft diameter below the key is 15 ft (5 m), and the interval below the key is lined with wire mesh anchored by rock bolts. The shaft terminates at the facility horizon, approximately 2,150 ft (655 m) deep. This shaft has no sump.

### **3.3.1 Exhaust Shaft Observations**

Quarterly Exhaust Shaft video inspections were conducted according to approved WIPP procedures. Inspections were performed to evaluate the condition and to verify the integrity of the shaft. The shaft was examined for cracks, corrosion, salt buildup, leaks, and debris. In addition, inspections examined the condition of anchors, brackets, and down-hole equipment. Between July 2006 and June 2007, four quarterly shaft inspections were conducted on August 22, 2006; November 14, 2006; March 2, 2007; and May 23, 2007.

#### **3.3.1.1 Video Camera**

Video inspections use a custom-designed vertical-drop color camera in an aerodynamic housing, suspended by a dual-armored cable, with pan, tilt, and zoom capability. The cable contains five copper conductors and two multi-mode optical fibers. It is reeled out by a winch mounted in a control van. Inspections are recorded electronically.

#### **3.3.1.2 Shaft Inspection Observations**

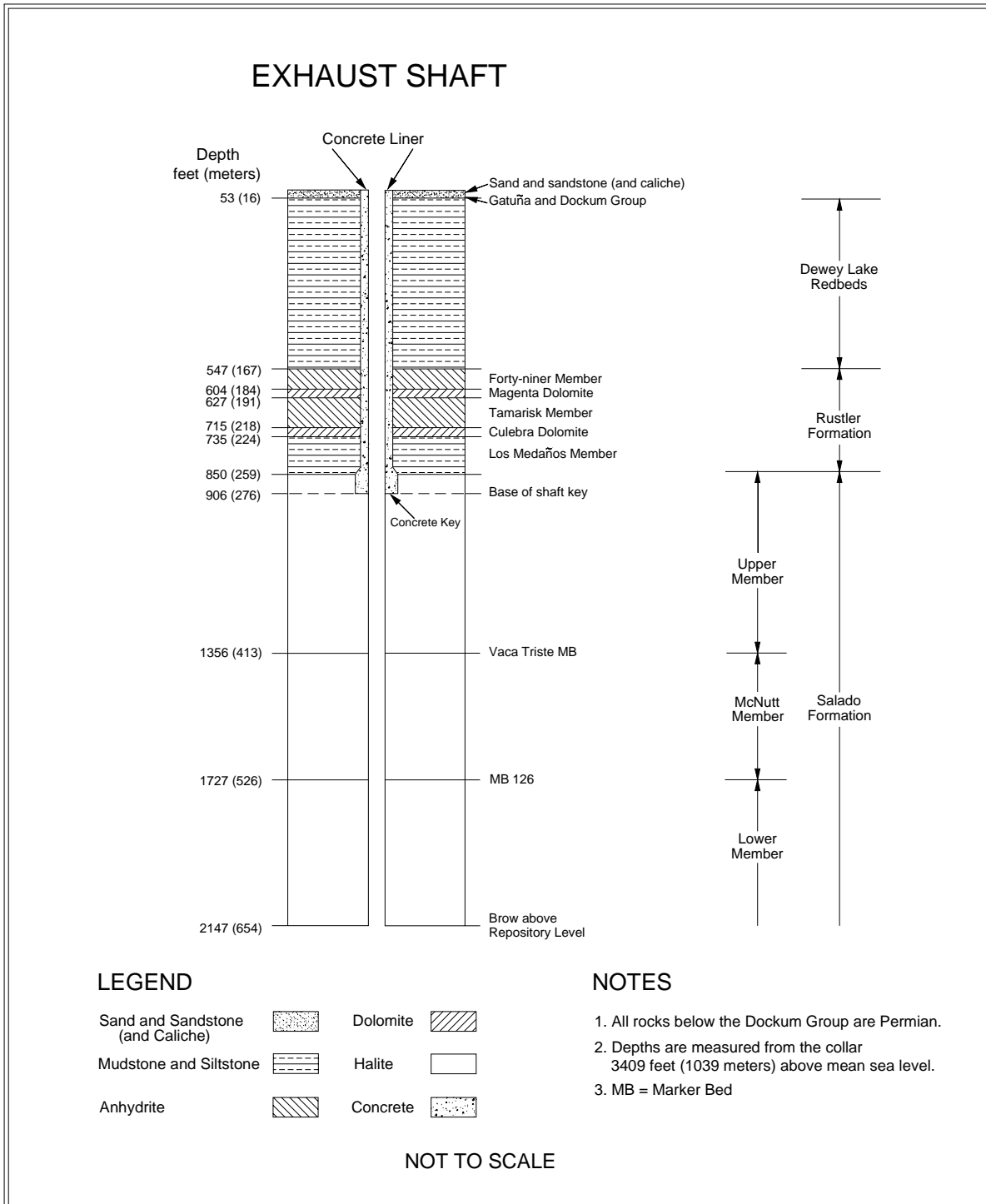
Quarterly video inspection observations concentrate on four major areas: air monitoring components, shaft liner, shaft walls, and equipment support and cabling. The air monitoring components consist of one air-velocity and three air-monitoring devices as shown in Figure 3-8. The video inspection includes examination of each device, including the transport assembly, guide tubes, the sample intake, and the support brackets that extend from Station "A" above the shaft to the Exhaust Shaft collar. Air monitoring components extend from the collar 21 ft into the shaft. Video inspections indicate that the air-sampling components can accumulate salt buildup of up to several inches thick.

The Exhaust Shaft liner is examined for cracks, seepage, and general shaft stability. Currently, there are three principal zones of seepage in the shaft. The first is about 50 to 55 ft below the shaft collar (bsc). The second is about 60 to 65 ft bsc. The third is about 75 to 80 ft bsc, as shown in Figure 3-9. Monitoring of seepage horizons started before 1995. Water entering the shaft through these cracks is believed to originate from a perched aquifer at the base of the Santa Rosa Formation that is being recharged as the result of surface modifications at the site. The fluid level in the Santa Rosa near the shaft is about 43 to 44 ft below the surface. Based on examination of inspection videos, the flow rate into the shaft during this reporting period is estimated at about 1 to 1-1/2 gallons per minute, most of which is carried out of the shaft with the exhaust air. Seepage cracks are confined primarily to the eastern side of the shaft wall.

**Geotechnical Analysis Report for July 2006 – June 2007**  
**DOE/WIPP-08-3177, Vol. 1**

---

When fluid was detected seeping into the Exhaust Shaft, a catch basin was designed and installed at the base of the shaft to intercept water and prevent it from draining into the Waste Shaft Sump. Fluid was removed from the catch basin from March 1996 through October 2005 as needed. The catch basin was damaged in 2004 by fallen debris, either salt or instrumentation cables or both. A new catch basin was fabricated and installed in December 2004. This basin was damaged in August 2005, most likely the result of fallen debris. An interception well system was installed between November 2005 and March 2006 to replace the catch basin. Interception wells were drilled down-gradient in S-400 between E-140 and E-300 (Figure 3-10). The interception well system consists of four 30-ft deep 9-7/8-in diameter holes with a submersible pump and pressure transmitter in each. Fluid is pumped from each borehole to a series of storage containers in S-550. A data-acquisition system monitors the fluid level in each hole, turning the pump on or off between set limits as needed.



**Figure 3-7 – Exhaust Shaft Stratigraphy**

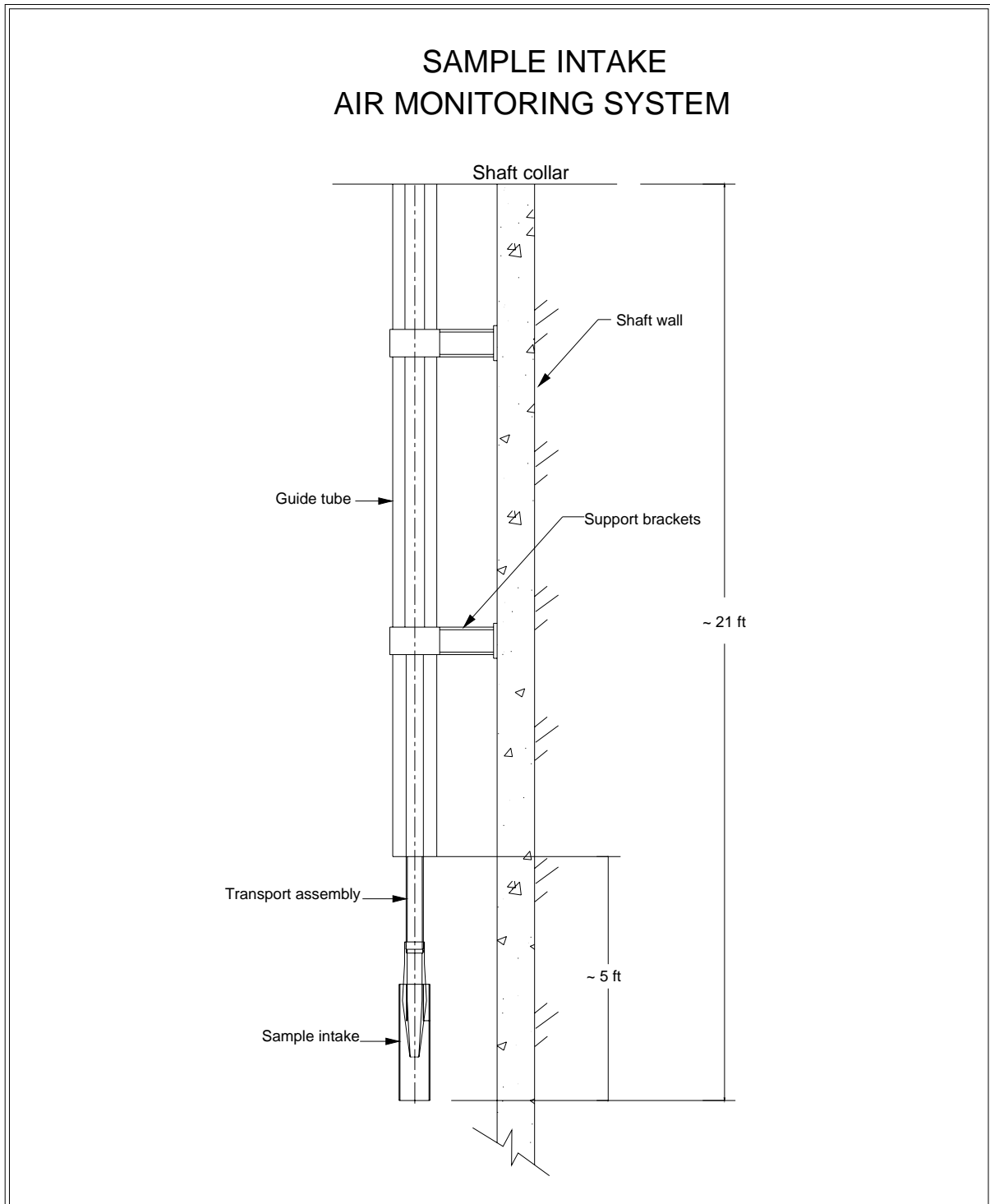
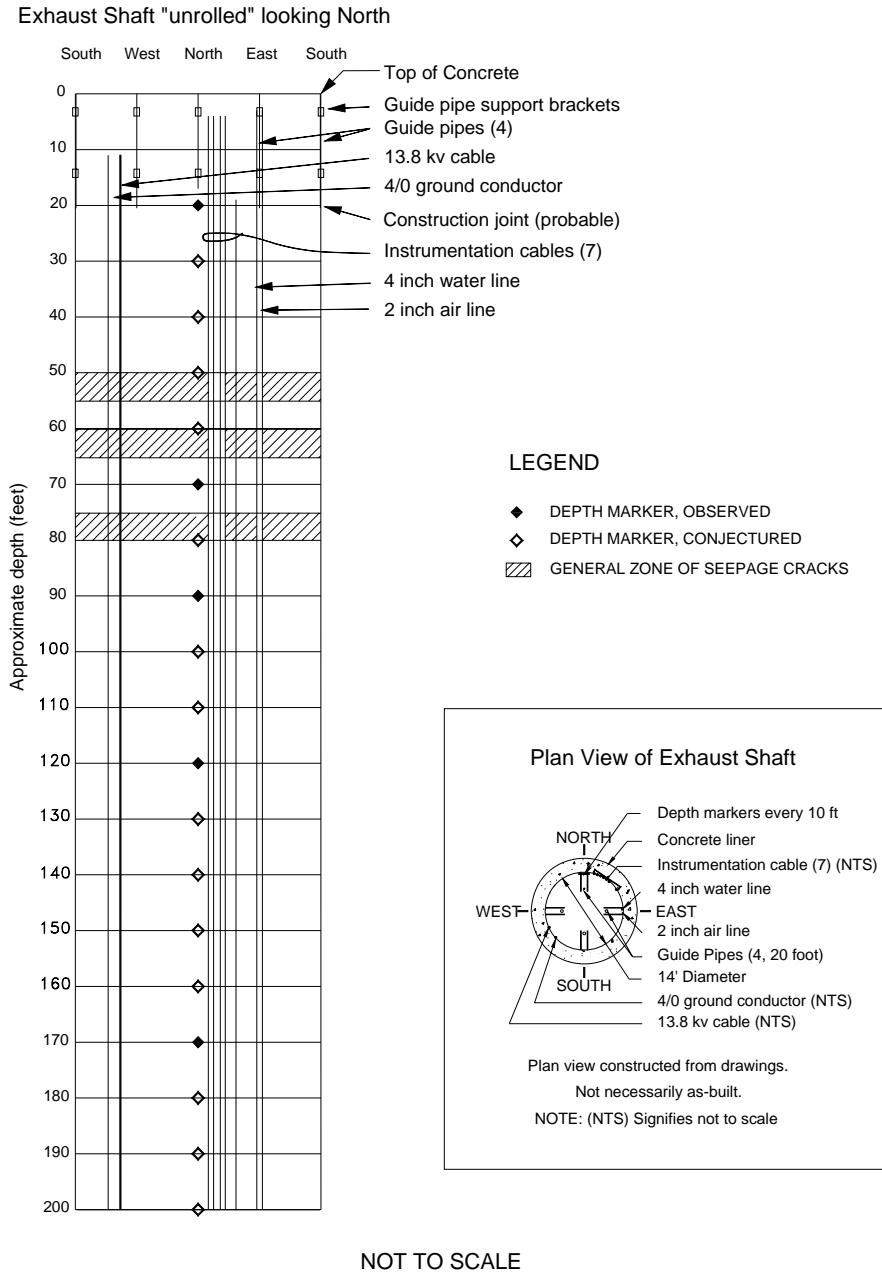


Figure 3-8 – Sample Intake of Exhaust Shaft Air Monitoring System

## DIAGRAM OF EXHAUST SHAFT FIXTURES (200' UPPER PORTION)



**Figure 3-9 – Diagram of Exhaust Shaft Fixtures and Seepage Zones (Upper 200 ft)**

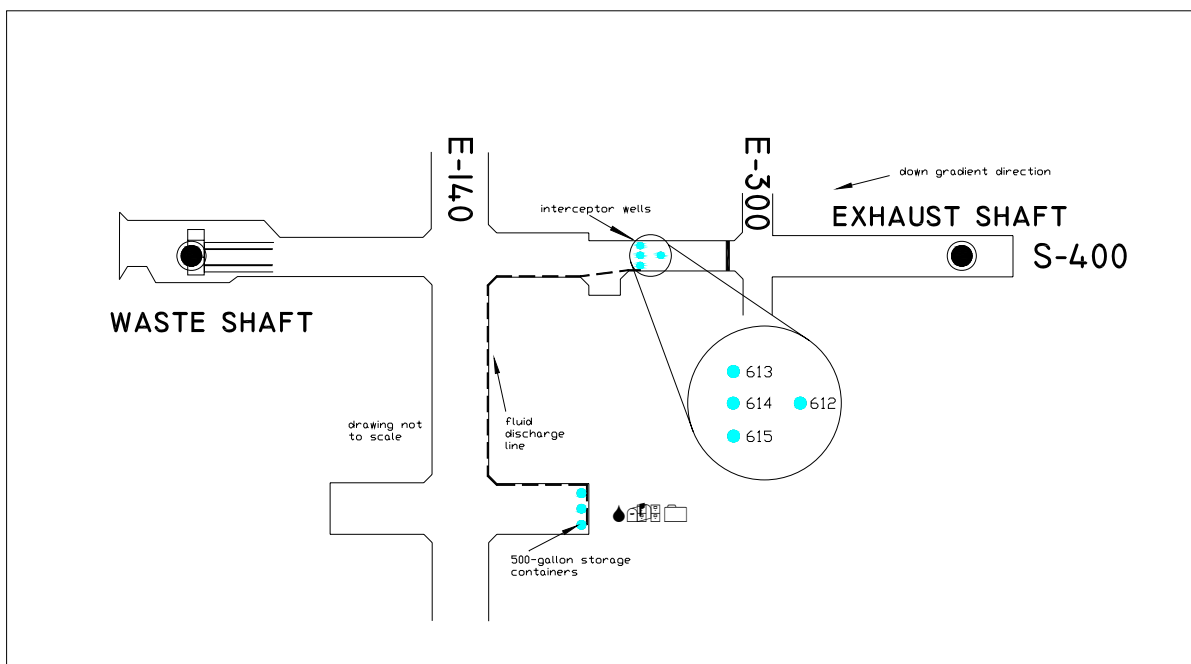


Figure 3-10 – Location of Interception Wells and Storage Containers

Table 3-1 presents the volume of fluid removed from the catch basin from July 1997 through June 2006, and by the interception well system from July 2006 through June 2007. The largest reported volumes are typically associated with periods of reduced ventilation and increased humidity. For a discussion of the factors affecting the quantity of fluid produced in the Exhaust Shaft, refer to DOE/WIPP 00-2000, *Brine Generation Study*.

The shaft walls were examined for salt buildup, cracks, moisture, and encrustations, with particular attention paid to power cables, instrument cables, air lines and waterlines and the three water rings at the base of the Magenta and Culebra members of the Rustler Formation and the bottom of the shaft key. The condition of the shaft wall varies depending on airflow, humidity, temperature, and underground mining activities. During this reporting period, there was significant mining activity in Panel 5 and the south access drifts. The principal areas in the shaft with significant salt buildup were the three water rings at the Magenta, the Culebra, and the key, and along upper portions of the shaft generally associated with power cables, support brackets, instrument cables, and the air lines and waterlines.

Though the Magenta and Culebra water rings are encrusted with salt buildup, no water appears to emanate from the liner or water rings. Most of the seepage was observed along the east face of the shaft wall near the instrumentation cables and the air lines and waterlines in the upper section of the shaft. Though the presence of water is an inconvenience requiring periodic disposal, at this time it does not appear to have created any hazard or affected the structural integrity of the shaft. However, brine increases the probability of corrosion and deterioration of utility hangers and brackets. There are no visible signs of dissolution of the salt below the key.



**Geotechnical Analysis Report for July 2006 – June 2007**  
**DOE/WIPP-08-3177, Vol. 1**

---

The video inspection also focused on the installed utilities and support brackets. These include a 13.8 kVA power cable that is no longer active and the grounding cable on the west wall of the shaft, the instrumentation cables on the northeast wall of the shaft, and the 4-in air-line and the 2-in waterline on the east wall of the shaft. In the August 19, 2006, video, salt buildups 6 to 12 in thick were noted surrounding the inactive power cable about 112 to 150 ft bsc. Later video inspections show that salt crust sloughing extended to about 135 ft bsc between the August and November inspections.

Sporadic salt buildup continues on all cables. The long-term implication of salt buildup is increased loading on cables and cable hangers, accompanied by intermittent falls of debris. The 4-in compressed air-line and the 2-in water-line extend from the surface to the bottom of the shaft. At present, neither line is being used. The integrity of the brackets holding the air-line and water-line was difficult to assess because of salt buildup; however, there was no indication that the brackets were broken. Instrumentation cable breaks were observed in the shaft; however, most of these breaks affected abandoned cables, with negligible impact on shaft monitoring and operations.

**Geotechnical Analysis Report for July 2006 – June 2007**  
**DOE/WIPP-08-3177, Vol. 1**

**Table 3-1 – Water Removed from the Exhaust Shaft Catch Basin and the Interception Well System**

July 1997 - June 1998		July 1998 - June 1999		July 1999 - June 2000		July 2000 - June 2001		July 2001 - June 2002		July 2002 - June 2003	
Date	Gallons	Date	Gallons	Date	Gallons	Date	Gallons	Date	Gallons	Date	Gallons
7/18/1997	275	7/1/1998	770	7/19/1999	110	7/3/2000	220	7/31/2001	165	7/2/2002	165
7/28/1997	660	7/7/1998	330	12/13/1999	165	7/15/2000	110	8/21/2001	1,595	7/8/2002	440
8/1/1997	550	7/14/1998	220	2/21/2000	110	9/18/2000	330	9/13/2001	330	7/9/2002	495
8/4/1997	715	7/16/1998	275	5/16/2000	715	10/24/2000	110	10/15/2001	770	7/10/2002	660
8/8/1997	770	7/23/1998	165	6/7/2000	165	3/7/2001	110	10/30/2001	220	7/30/2002	220
8/11/1997	660	7/24/1998	220	6/12/2000	275	3/21/2001	165	4/29/2002	275	9/17/2002	165
8/15/1997	475	7/27/1998	825	6/19/2000	440	4/10/2001	220	6/11/2002	550	9/24/2002	330 Sludge
8/18/1997	330	7/28/1998	330	6/22/2000	330	4/17/2001	220	6/22/2002	330	3/25/2003	220 Sludge
8/22/1997	330	8/3/1998	495	6/30/2000	165	4/24/2001	110	<b>TOTAL</b>	<b>4,235</b>	5/27/2003	55
8/25/1997	1045	8/10/1998	1265	<b>TOTAL</b>	<b>2,475</b>	5/22/2001	110			6/3/2003	220
8/25/1997	110 Sludge	8/21/1998	330			5/22/2001	440 Sludge			6/25/2003	330
9/2/1997	220	8/24/1998	990			6/12/2001	1100			<b>TOTAL</b>	<b>3,300</b>
9/15/1997	605	8/27/1998	1155			6/13/2001	110				
9/22/1997	550	9/1/1998	330			6/13/2001	110				
10/13/1997	825	10/5/1998	385			<b>TOTAL</b>	<b>3,025</b>				
10/20/1997	220	10/26/1998	660								
11/3/1997	275	11/23/1998	110								
11/10/1997	385	2/1/1999	385								
11/17/1997	385	2/10/1999	110								
11/24/1997	330	5/4/1999	330								
12/10/1997	440	5/11/1999	110								
12/12/1997	550	5/24/1999	605								
1/2/1998	220	5/26/1999	165								
1/12/1998	605	5/28/1999	165								
2/2/1998	660	6/1/1999	165								
2/16/1998	605	6/4/1999	165								
3/16/1998	605	6/10/1999	165								
5/4/1998	660	6/10/1999	165 Sludge								
5/11/1998	550	6/16/1999	165								

**Geotechnical Analysis Report for July 2006 – June 2007**  
**DOE/WIPP-08-3177, Vol. 1**

**Table 3-1 – Water Removed From the Exhaust Shaft Catch Basin and the Interception Well System (Continued)**

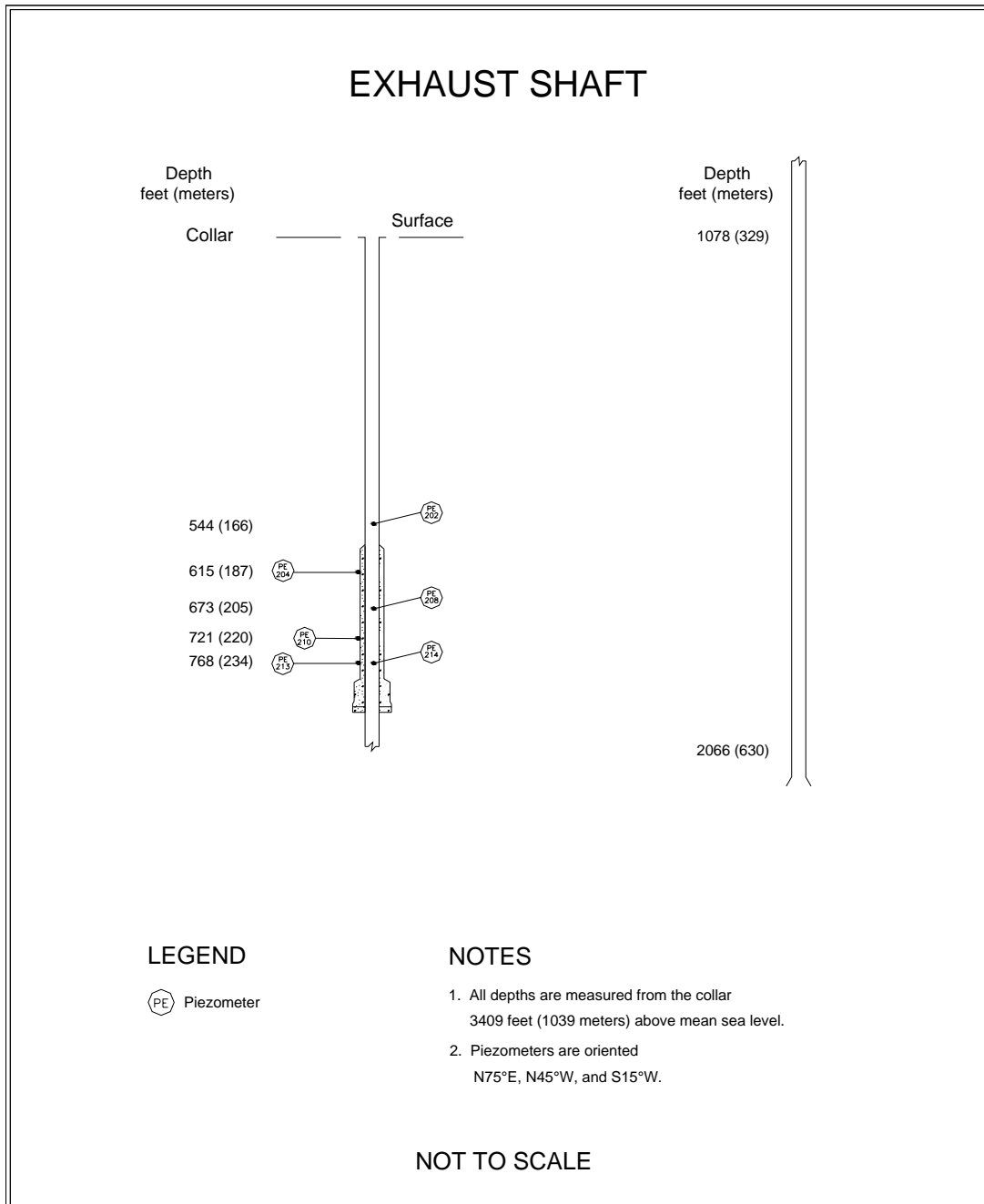
July 1997 - June 1998		July 1998 - June 1999		July 1999 - June 2000		July 2000 - June 2001		July 2001 - June 2002		July 2002 - June 2003	
Date	Gallons	Date	Gallons	Date	Gallons	Date	Gallons	Date	Gallons	Date	Gallons
5/18/1998	495	6/21/1999	1,705								
5/20/1998	110	6/23/1999	275								
6/1/1998	330	6/30/1999	605								
6/10/1998	90	<b>TOTAL</b>	<b>14,135</b>								
6/15/1998	385										
6/22/1998	<b>165</b>										
<b>TOTAL</b>	<b>16,185</b>										

July 2003 - June 2004		July 2004 - June 2005		July 2005 - June 2006		July 2006 - June 2007					
Date	Gallons	Date	Gallons	Date	Gallons	Date	Gallons				
7/8/2003	605	11/29/2004	660 Sludge	8/1/2005	1,100	7/11/2006	250				
7/9/2003	550	12/6/2004	275 Sludge	8/15/2005	880	8/116/2006	420				
7/17/2003	165	1/3/2005	440	10/10/2005	715 Sludge	8/17/2006	400				
8/12/2003	275	1/4/2005	220	<b>TOTAL</b>	<b>2,675</b>	9/1/2006	420				
10/14/2003	165	1/10/2005	385			9/7/2006	420				
10/20/2003	440	5/16/2005	660			9/18/2006	840				
10/21/2003	330	6/1/2005	660			11/10/2006	150				
11/23/2003	220	6/6/2005	220			11/15/2006	400				
11/23/2003	660 Sludge	6/20/2005	440			1/30/2007	310				
<b>TOTAL</b>	<b>3,300</b>	6/27/2005	220			5/11/2007	75				
		<b>TOTAL</b>	<b>4,180</b>			6/20/2007	200				
						<b>TOTAL</b>	<b>3,885</b>				

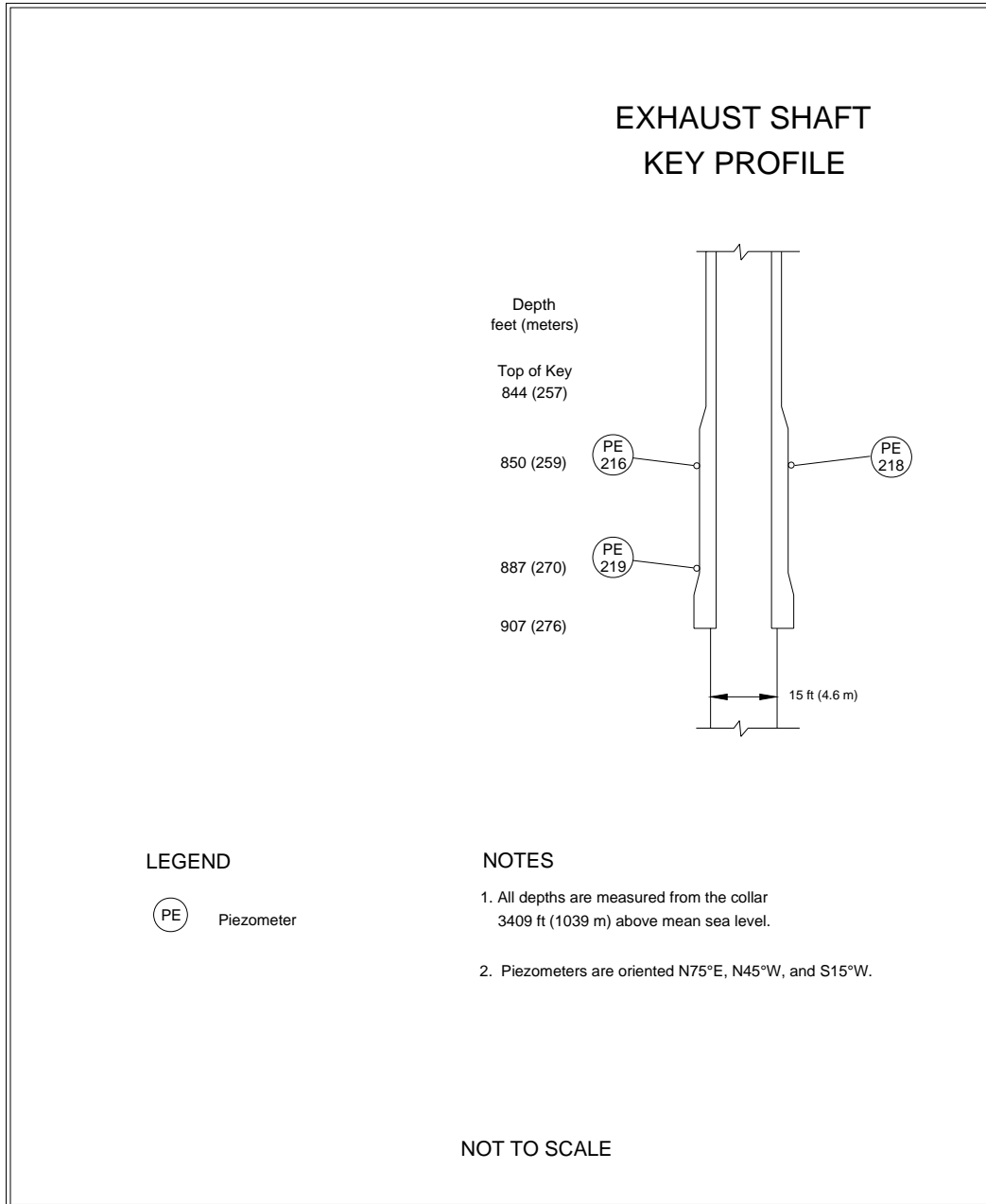
### **3.3.2 Instrumentation**

The Exhaust Shaft was equipped with geomechanical instrumentation in two stages. Earth pressure cells were installed behind the liner key in November 1984. Piezometers and nine multiposition borehole extensometers were installed during November and December 1985. Figures 3-11 and 3-12 show the instrument locations.

Nine piezometers remain in working condition. The fluid pressure readings from the working piezometers at the end of the reporting period range from -2 psi (-14 kPa) at 544-ft (166-m) to 141 psi (972 kPa) at 721-ft (220-m). Maximum pressure readings from the working piezometers during this reporting period were consistent with maximum readings from the previous reporting period.



**Figure 3-11 – Exhaust Shaft Instrumentation (Without Shaft Key)**



**Figure 3-12 – Exhaust Shaft Key Instrumentation**

### 3.4 Air Intake Shaft

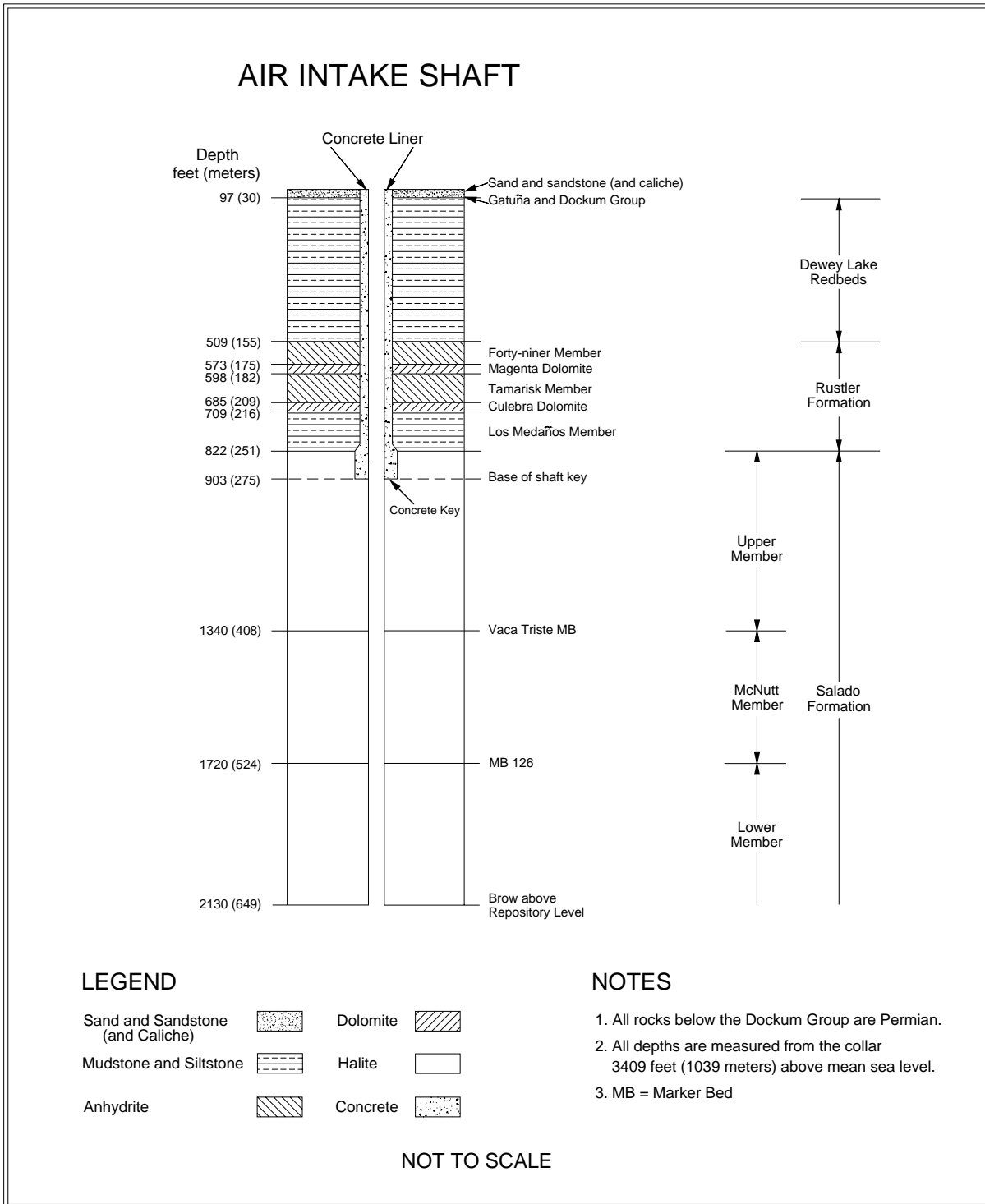
The Air Intake Shaft was drilled from December 4, 1987, to August 31, 1988, to establish a primary route for surface air to enter the repository (see Figure 1-2). The stratigraphy was mapped from September 14, 1988, to November 14, 1989 (Holt and Powers, 1990). Figure 3-13 summarizes the Air Intake Shaft stratigraphy.

The Air Intake Shaft is lined with non-reinforced concrete from the surface to the bottom of the shaft key at 903 ft (275 m). The Air Intake Shaft key is 81 ft (25 m) long with an

inside diameter of 16 ft (5 m). The shaft diameter below the key is 20 ft (6 m), and the shaft below the key is unlined to the facility horizon at 2,150 ft (655 m). The shaft walls are bolted and meshed from just below the key all the way down to the shaft station. The Air Intake Shaft has no sump.

#### **3.4.1 Shaft Performance**

Weekly visual inspections were performed on the Air Intake Shaft during this reporting period, and the shaft was found to be in satisfactory condition. No ground control activities other than routine maintenance were required during this reporting period.



**Figure 3-13 – Air Intake Shaft Stratigraphy**



## **4.0 PERFORMANCE OF SHAFT STATIONS**

This chapter describes the instrumentation and geomechanical performance of the shaft stations at the base of the Salt Shaft, the Waste Shaft, and the Air Intake Shaft. The Exhaust Shaft does not have an enlarged shaft station and, therefore, is not included in this chapter.

### **4.1 Salt Shaft Station**

The Salt Shaft Station was excavated by drilling and blasting between May 2 and June 3, 1982. In 1987 the station was enlarged by removing the roof beam up to Anhydrite "b" between S-90 and N-20 using a mechanical scaler. In 1995, the remaining roof beam at the north end of the station was also removed up to Anhydrite "b". The station area south of the shaft is 90 ft (27.5 m) long and 32 to 38 ft (10 to 12 m) wide. The height of the station south of the shaft is 18 ft (5.5 m). The station dimensions north of the shaft are approximately 30 ft (9 m) long, 32 to 35 ft (10 to 11 m) wide, and 18 ft (5.5 m) high. The shaft extends approximately 140 ft (43 m) below the facility horizon to accommodate the skip loading equipment and to act as a sump. Figure 4-1 shows a generalized cross section of the station.

#### **4.1.1 Modifications to Excavation and Ground Control Activities**

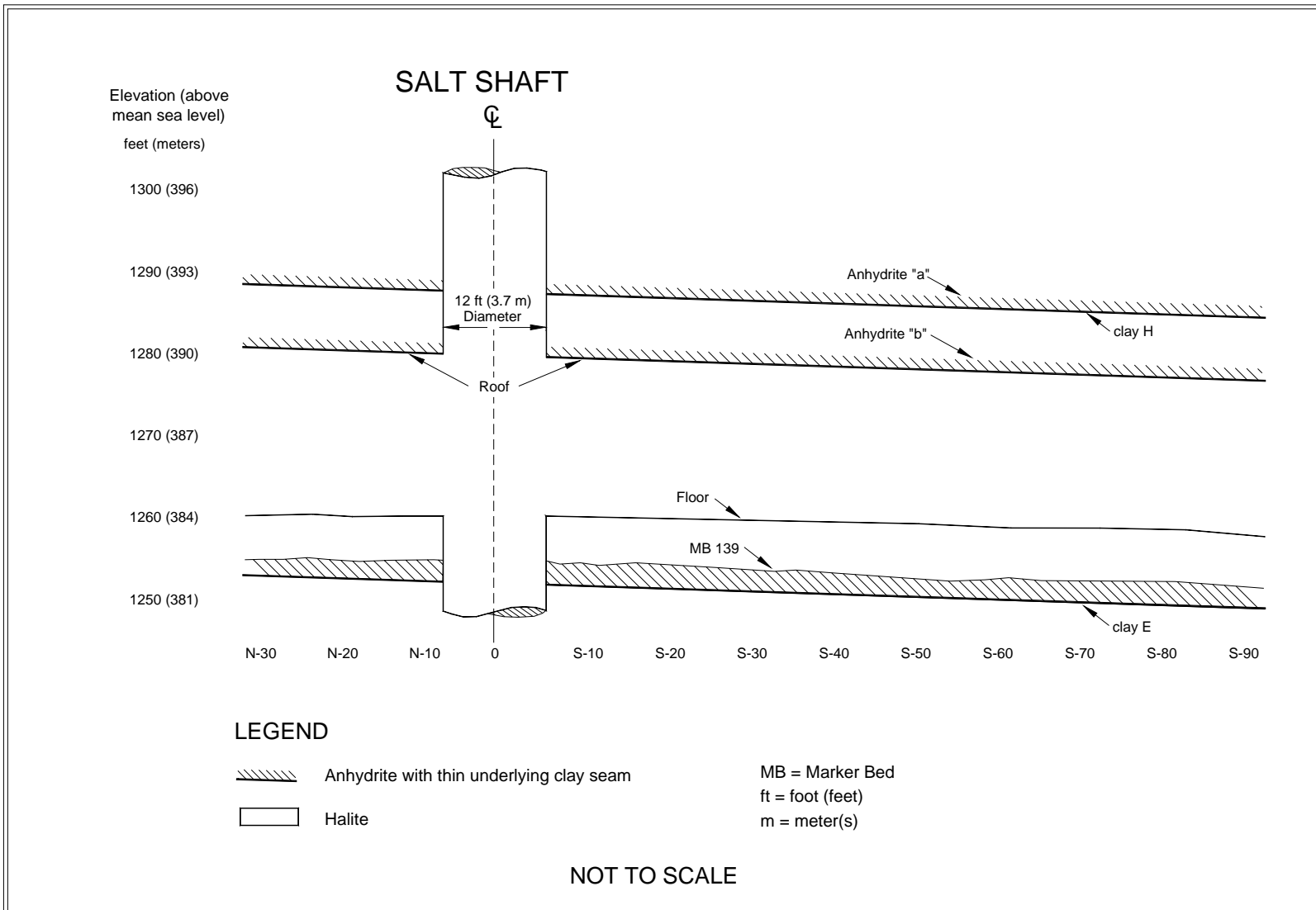
No significant modifications were performed in the Salt Shaft Station during this reporting period. Ground control was performed as routine maintenance.

#### **4.1.2 Instrumentation**

Geomechanical instrumentation was installed in the Salt Shaft Station between June 1982 and February 1983, with subsequent reinstallation of extensometers and convergence points as necessary. Figure 4-2 shows the instrument locations after the roof beam was taken down.

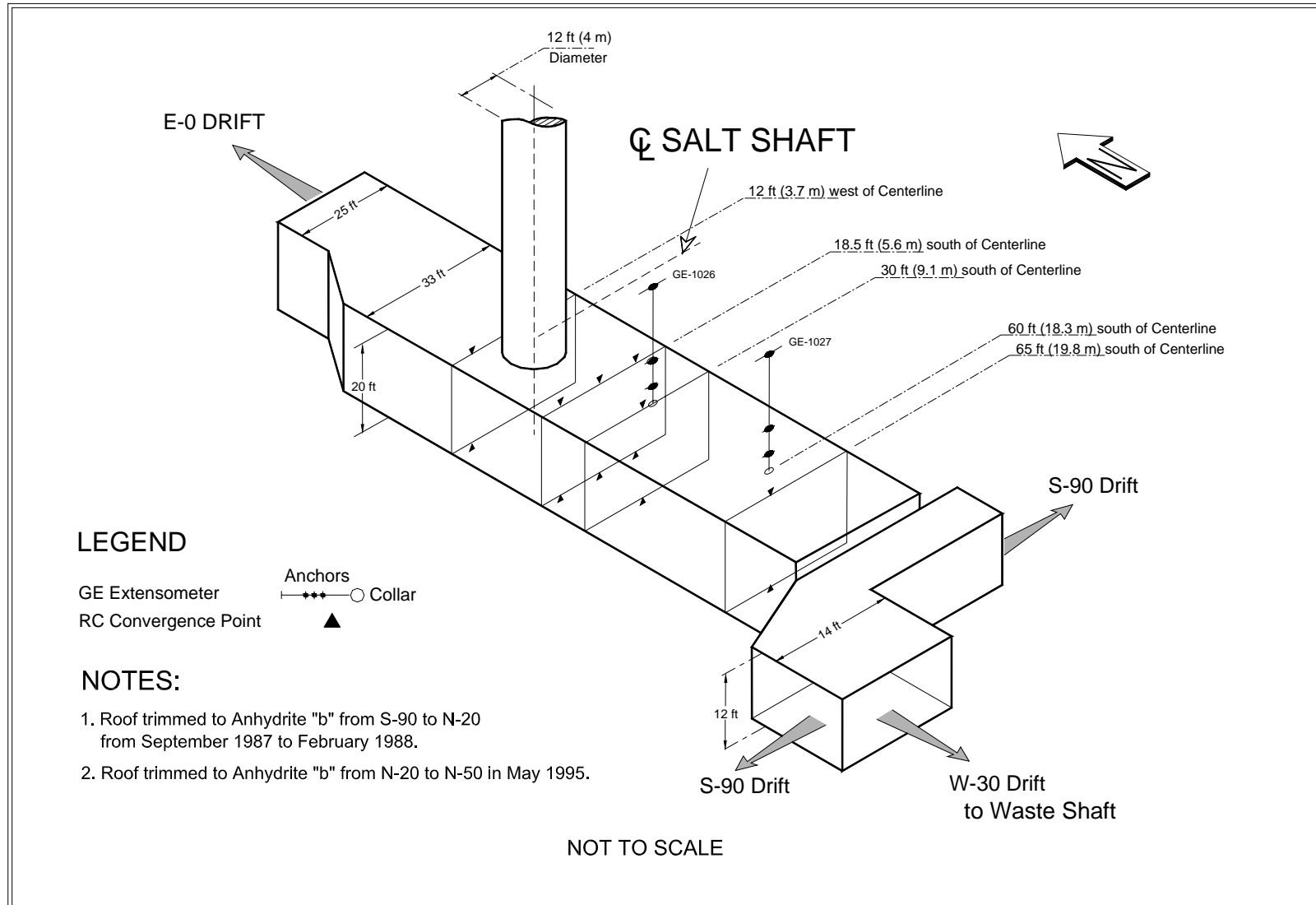
Four vertical convergence point arrays are currently monitored. Table 4-1 summarizes the vertical closure rates in the Salt Shaft Station from July 2006 through June 2007. Salt Shaft Station vertical closure rates indicate that the rates are slightly higher than during the previous reporting period.

**Geotechnical Analysis Report for July 2006 – June 2007**  
**DOE/WIPP-08-3177, Vol. 1**



**Figure 4-1 – Salt Shaft Station Stratigraphy**

**Geotechnical Analysis Report for July 2006 – June 2007  
DOE/WIPP-08-3177, Vol. 1**



**Figure 4-2 – Salt Shaft Station Instrumentation after Roof Beam Excavation**

**Geotechnical Analysis Report for July 2006 – June 2007  
DOE/WIPP-08-3177, Vol. 1**

**Table 4-1 – Vertical Closure Rates in the Salt Shaft Station**

Location	Chord <sup>*</sup>	Last Reading	Total Cumulative Displacement Inches (cm.)	Closure Rate 2006 to 2007 in/yr (cm/yr)	Closure Rate 2005 to 2006 in/yr (cm/yr)	Rate Change Percent <sup>a</sup>	Comments
E0, S18	A-E	06/11/07	31.063 (78.900)	1.51 (3.84)	1.36 (3.45)	11	
E0, S18	B-D	06/11/07	31.703 (80.526)	1.64 (4.17)	1.50 (3.81)	9	
E0, S18	F-H	06/11/07	20.075 (50.991)	1.03 (2.62)	0.95 (2.41)	8	
E0, S30	A-C	06/11/07	45.699 (116.075)	1.55 (3.94)	1.46 (3.71)	6	
E0, S65	A-C	06/11/07	40.716 (103.419)	1.15 (2.92)	1.02 (2.59)	13	

<sup>\*</sup>Chord is defined in "Geotechnical Analysis Report for July 2006–June 2007 Supporting Data."

<sup>a</sup> Increase in convergence rate is calculated from the difference between the 2006–2007 rate and the 2005–2006 rate.

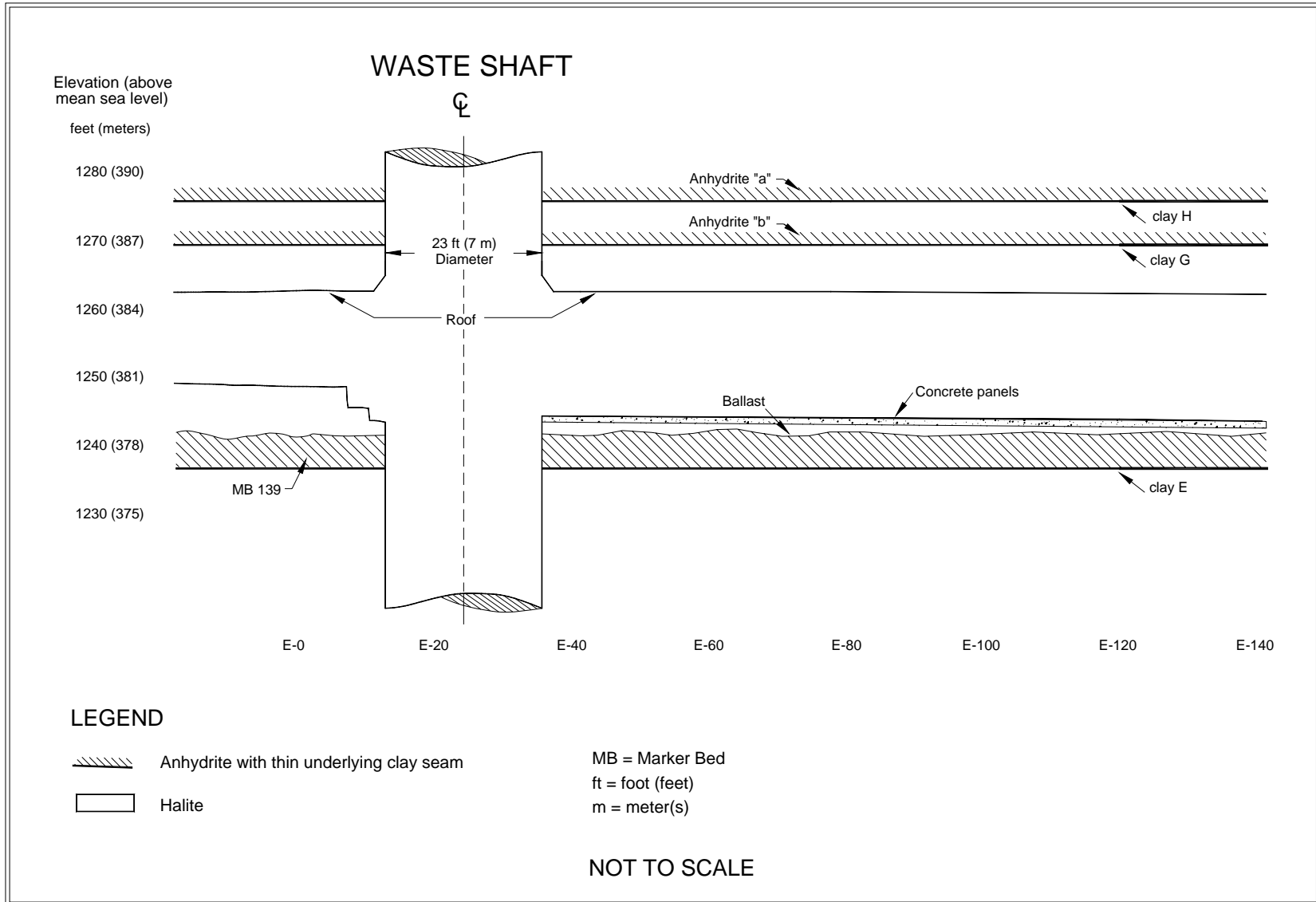
## **4.2 Waste Shaft Station**

The Waste Shaft Station was initially excavated with a continuous miner as a ventilation connection to a 6-ft (2-m) diameter exhaust shaft in November 1982. In 1984, the station was enlarged to a height of 15 to 20 ft (4.5 to 6 m) and a width of 20 to 30 ft (6 to 9 m). The station is approximately 150 ft (46 m) long. In 1988, the station walls were trimmed, and concrete was placed on the floor. Since 1988, the Waste Shaft Station has undergone three major floor renovations. A 53-ft (16-m)-long section of the reinforced concrete was removed in February 1991, in 1995 an additional 30-ft (9-m) section was removed, and in 2000 floor maintenance included trimming of the floor and reinstallation of the rails supported by segmented concrete panels on a crushed rock backfill. Figure 4-3 shows a cross-section of the Waste Shaft Station.

### **4.2.1 Modifications to Excavation and Ground Control Activities**

Bolt tails were trimmed, and some cable shoe anchors were replaced to provide additional operating clearance for waste handling operations.

**Geotechnical Analysis Report for July 2006 – June 2007**  
**DOE/WIPP-08-3177, Vol. 1**



**Figure 4-3 – Waste Shaft Station Stratigraphy**

**Geotechnical Analysis Report for July 2006 – June 2007**  
**DOE/WIPP-08-3177, Vol. 1**

---

**4.2.2 Instrumentation**

Instruments were initially installed in the Waste Shaft Station between November 12 and December 2, 1982. Figure 4-4 illustrates the locations after enlargement. Three extensometers in the Waste Shaft Station are currently being monitored. In addition, horizontal convergence is being monitored at E-30 and E-90.

Table 4-2 summarizes the recent history of the roof extensometers in the Waste Shaft Station. Extensometer 51X-GE-00268 (W-30) is installed in a borehole drilled into the roof of the station. Extensometers 51X-GE-00356 and 51X-GE-00357 monitor fracture dilation along the shaft wall above the east brow.

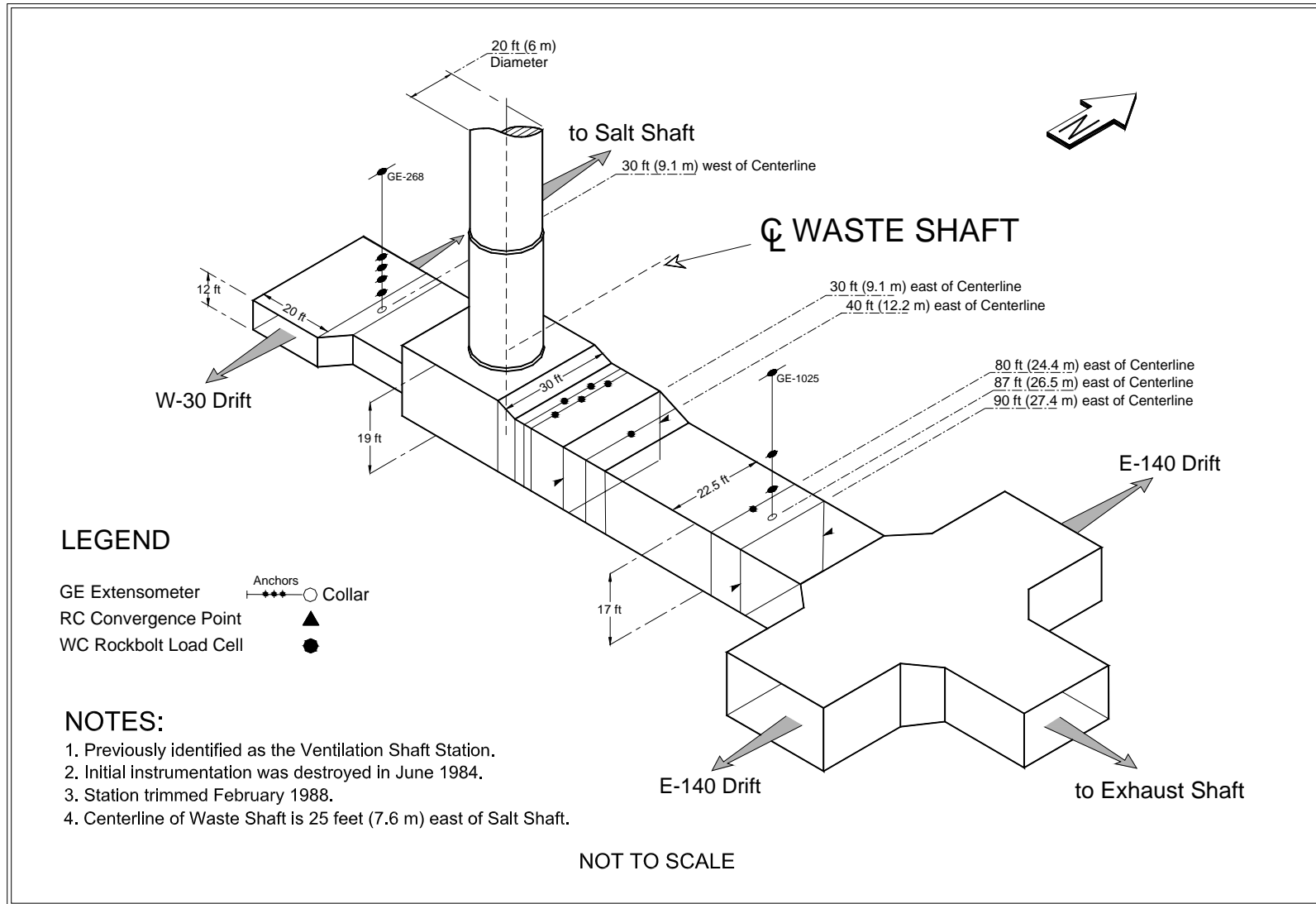
**Table 4-2 – Summary of Roof Extensometers in Waste Shaft Station**

Instrument	Location	Last Reading	Collar Displacement Relative to Deepest Anchor in (cm)	Displacement Rate 2006 to 2007 in/yr (cm/yr)	Displacement Rate 2005 to 2006 in/yr (cm/yr)	Rate Change Percent <sup>a</sup>	Comments
51X-GE-00268	S400, W30	06/11/07	9.383 (23.833)	0.25 (0.64)	0.28 (0.71)	-11%	
51X-GE-00356	Waste Shaft Brow	06/25/07	0.233 (0.592)	0.08 (0.20)	0.08 (0.20)	0%	
51X-GE-00357	Waste Shaft Brow	05/05/07	0.509 (1.293)	0.20 (0.51)	0.20 (0.51)	0%	

<sup>a</sup> Change is calculated from the difference between the 2006–2007 rate and the 2005–2006 rate.

Table 4-3 summarizes the annual horizontal closure rates calculated from convergence point data for this reporting period. The data indicate an increase in the horizontal closure rates at both E-30 and E-90 of 11 percent relative to the previous annual closure rates.

**Geotechnical Analysis Report for July 2006 – June 2007**  
**DOE/WIPP-08-3177, Vol. 1**



**Figure 4-4 – Waste Shaft Station Instrumentation after Wall Trimming**

**Geotechnical Analysis Report for July 2006 – June 2007  
DOE/WIPP-08-3177, Vol. 1**

---

Eighteen rock bolt load cells are installed in the roof and brow of the Waste Shaft Station. The loads on 12 of these rock bolt load cells are monitored regularly. Ten load cells are used to monitor loading on the brow cable support anchor shoes. Load cells at E-40 and E-80 are used to monitor the performance of the threaded bar anchorage.

**Table 4-3 – Horizontal Closure Rates in the Waste Shaft Station**

Location	Chord <sup>1</sup>	Last Reading	Total Cumulative Displacement Inches (cm)	Closure Rate 2006 to 2007 in/yr	Closure Rate 2005 to 2006 in/yr	Rate change Percent <sup>a</sup>	Comments
S400, E30	C-H	05/29/07	19.238 (48.865)	0.91 (2.31)	0.82 (2.08)	11%	
S400, E90	C-G	05/29/07	21.980 (55.829)	1.05 (2.67)	0.95 (2.41)	11%	

<sup>1</sup>Chord is defined in "Geotechnical Analysis Report for July 2006–June 2007 Supporting Data."

<sup>a</sup> Increase in convergence rate is calculated from the difference between the 2006–2007 rate and the 2005–2006 rate.

### **4.3 Air Intake Shaft Station**

The Air Intake Shaft Station was excavated in late 1987 and early 1988, using a continuous miner. The Air Intake Shaft is furnished with a work platform and a small cage that can be raised and lowered to perform routine ground maintenance. The principal purpose of that equipment is to provide emergency access.

#### **4.3.1 Modifications to Excavation and Ground Control Activities**

No ground control activities were performed in the Air Intake Shaft Station other than routine roof and rib maintenance and replacement of failed roof bolts.

#### **4.3.2 Instrumentation**

Radial convergence point and extensometer instrumentation data near the Air Intake Shaft Station are presented in Chapter 5.0 as part of the discussion on the performance of the access drifts. Twenty rock bolt load cells installed in the Air Intake Shaft Station area are monitored regularly.



## **5.0 PERFORMANCE OF ACCESS DRIFTS**

This chapter describes the geomechanical performance of the central underground access drifts. The Waste Disposal Area is discussed in Chapter 6.0. Four major north-south drifts in the WIPP underground are intersected by shorter east-west cross-drifts. Drift dimensions range from 13 ft (4 m) to 21 ft (6.4 m) high and from 14 ft (4.3 m) to 33 ft (9.2 m) wide.

### **5.1 Modifications to Excavation and Ground Control Activities**

Access drifts into Panel 5 were completed during this reporting period. Trimming, scaling, and floor milling activities were performed as necessary in many areas. Table 5-1 summarizes these activities. It also summarizes ground control activities (e.g., rock bolting and installing wire mesh) in various locations in the access drifts.

### **5.2 Instrumentation**

This section discusses instrumentation details and locations for each instrumentation type.

#### **5.2.1 Borehole Extensometers**

One new extensometer was installed during this reporting period in the E-300 North Experimental Area. This extensometer replaced a similar installation in the same location. All operating underground extensometers continue to be monitored. Thirty-seven borehole extensometers continue to be monitored.

#### **5.2.2 Convergence Points**

Figure 5-1 shows typical convergence point array configurations. Instrumentation installed during this reporting period was limited to the replacement of convergence point arrays in previously mined areas and the installation of new monitoring arrays in the newly mined areas. New and replacement convergence points were installed in 30 locations throughout the WIPP underground access drifts because of mining and trimming activities. Horizontal and vertical convergence point arrays were installed at various locations. Most of these installations were located in the southern access drifts. Convergence points within the access drifts are read manually at least every two months, with more frequent monitoring in some areas. Table 5-2 lists the new and replacement convergence points that were installed during this reporting period.

**Geotechnical Analysis Report for July 2006 – June 2007  
DOE/WIPP-08-3177, Vol. 1**

**Table 5-1 – Summary of Modifications and Ground Control Activities in the  
Access Drifts July 1, 2006, through June 30, 2007**

<b>Location</b>	<b>Work Activity</b>
E140 Drift	Trimmed floor between S400 and approximately S600.  Trimmed floor between S90 and N260.  Installed supplemental 12-ft resin-anchored bolts and mats between existing mats from S2520 to S2750.  Installed supplemental 12-ft resin-anchored bolts and mats between existing mats from S2180 to S2520.
E300 Drift Maintenance Shop Area	Installed double lanyards on resin-anchored bolts to reduce the risk of broken bolts falling.  Trimmed floor in maintenance shop between E140 and E300.
E300 Experimental Area (N1100 – N1400)	Installed 12-ft resin-anchored bolts and mats.
S400 Drift Shaft Station Area	Trimmed excess bolt tails to provide additional working height for RH operations in the station.  Replaced large existing cable shoes with lower profile cable anchor shoes.
N1400	Installed 4-ft mechanically anchored bolts and chain-link mesh in alcove east of E300.
S90	Installed 4-ft mechanically anchored bolts and chain-link mesh on ribs.
S1300 Shop Area	Installed 4-ft mechanically anchored bolts and chain link mesh on roof and ribs.
S2750	Installed substantial and isolation barriers in Panel 3 access.
S3080	Installed substantial and isolation barriers in Panel 3 access.
W30 Drift	Installed 12-ft resin-anchored bolts and mats to support the brow at S2650.
W170 Drift	Installed 12-ft resin-anchored bolts and mats at the S2900 truck bypass.  Installed 12-ft resin-anchored bolts and mats to support the ramp area brow at S2650.

**Table 5-2 – New and Replaced Convergency Points Installed in the  
Access Drifts July 1, 2006, through June 30, 2007**

<b>Location</b>	<b>N/R</b>	<b>Field Tag#</b>	<b>Chord</b>	<b>Date Installed</b>
E140, N150	R	E140-N150-4	A-C (Vertical)	09/15/06
E140, N220	R	E140-N220-3	A-C (Vertical)	09/27/06
E140, N355	R	E140-N355-2	A-C (Vertical)	09/27/06
E140, N5	R	E140-N5-6	A-C (Vertical)	09/15/06
E140, S1775	R	E140-S1775-3	I-E (Horizontal)	03/08/07
E140, S460	R	E140-S460-5	A-C (Vertical)	01/05/07
E140, S550	R	E140-S0550-5	A-C (Vertical)	01/05/07
E140, S90	R	E140-S90-4	A-C (Vertical)	09/15/06
E300, N1262	R	E300-N1262-3	A-C (Vertical)	06/22/07

**Geotechnical Analysis Report for July 2006 – June 2007**  
**DOE/WIPP-08-3177, Vol. 1**

**Table 5-2 – New and Replaced Convergency Points Installed in the  
Access Drifts July 1, 2006, through June 30, 2007**

Location	N/R	Field Tag <sup>#</sup>	Chord <sup>*</sup>	Date Installed
E300, N170	R	E300-N170-2	H-F (Vertical)	09/27/06
E300, N170	R	E300-N170-2	A-E (Vertical)	09/27/06
E300, N250	R	E300-N250-3	A-C (Vertical)	10/31/06
E300, S3480	N	E300-S3480	A-C (Vertical)	09/14/06
E300, S3480	N	E300-S3480	B-D (Horizontal)	09/14/06
N250, E220	R	N250-E220-2	B-D (Horizontal)	09/27/06
N250, E220	R	N250-E220-2	A-E (Vertical)	09/27/06
N250, E220	R	N250-E220-2	H-F (Vertical)	09/27/06
S1300, W100	R	S1300-W100-3	A-C (Vertical)	09/14/06
S3310, W100	R	S3310-W100-3	A-C (Vertical)	01/19/07
S3650, E220	N	S3650-E220	A-C (Vertical)	10/19/06
S3650, E55	N	S3650-E55	A-C (Vertical)	10/27/06
W30, S120	R	W30-S120-2	A-C (Vertical)	12/14/06
W30, S250	R	W30-S250-5	A-C (Vertical)	12/14/06
W30, S400	R	W30-S400-2	A-C (Vertical)	12/14/06
W30, S500	R	W30-S500-2	A-C (Vertical)	12/14/06
W30, S700	R	W30-S700-3	A-C (Vertical)	12/14/06
W30, S700	R	W30-S700-4	A-C (Vertical)	01/05/07
W30, S850	R	W30-S850-2	H-F (Vertical)	01/05/07
W30, S850	R	W30-S850-3	B-D (Horizontal)	01/05/07
W30, S850	R	W30-S850-3	A-E (Vertical)	01/05/07

N = New installation.

R = Replacement installation (i.e., instrument replaces older instrument that has failed or has been mined out).

<sup>#</sup> This column is a combination of the convergence point location followed by a "-X", where X represents the reinstallation number, when applicable,

<sup>\*</sup> A unique letter is assigned to each convergence array element around a particular opening. Chord refers to a particular array pair. The various array lettering schemes are shown in Figure 5-1.

### 5.3 Analysis of Convergence Point and Extensometer Data

Convergence point data are obtained by measuring the change in distance between fixed points anchored into the rock across an opening, either from rib-to-rib or from roof-to-floor. Extensometer data are obtained by measuring the displacement from the reference head anchor (collar) to each fixed anchor of the extensometer. These measurements are made, at a minimum, every two months throughout the WIPP underground, except when convergence points are not accessible. Convergence rates and extensometer displacement rates indicate how an excavation is performing; rates that decrease or are relatively constant typify stable excavations, whereas increasing rates may indicate some type of developing instability or may be the response to nearby mining.

Where possible, annual closure rates were calculated from convergence point array data gathered in the access drifts. A complete tabulation of these convergence point data and calculated closure rates is presented in the supporting data document for this report. Locations with increases in annual vertical closure rates of greater than 10 percent are shown in Table 5-3.

TYPICAL CONVERGENCE POINT ARRAY CONFIGURATIONS

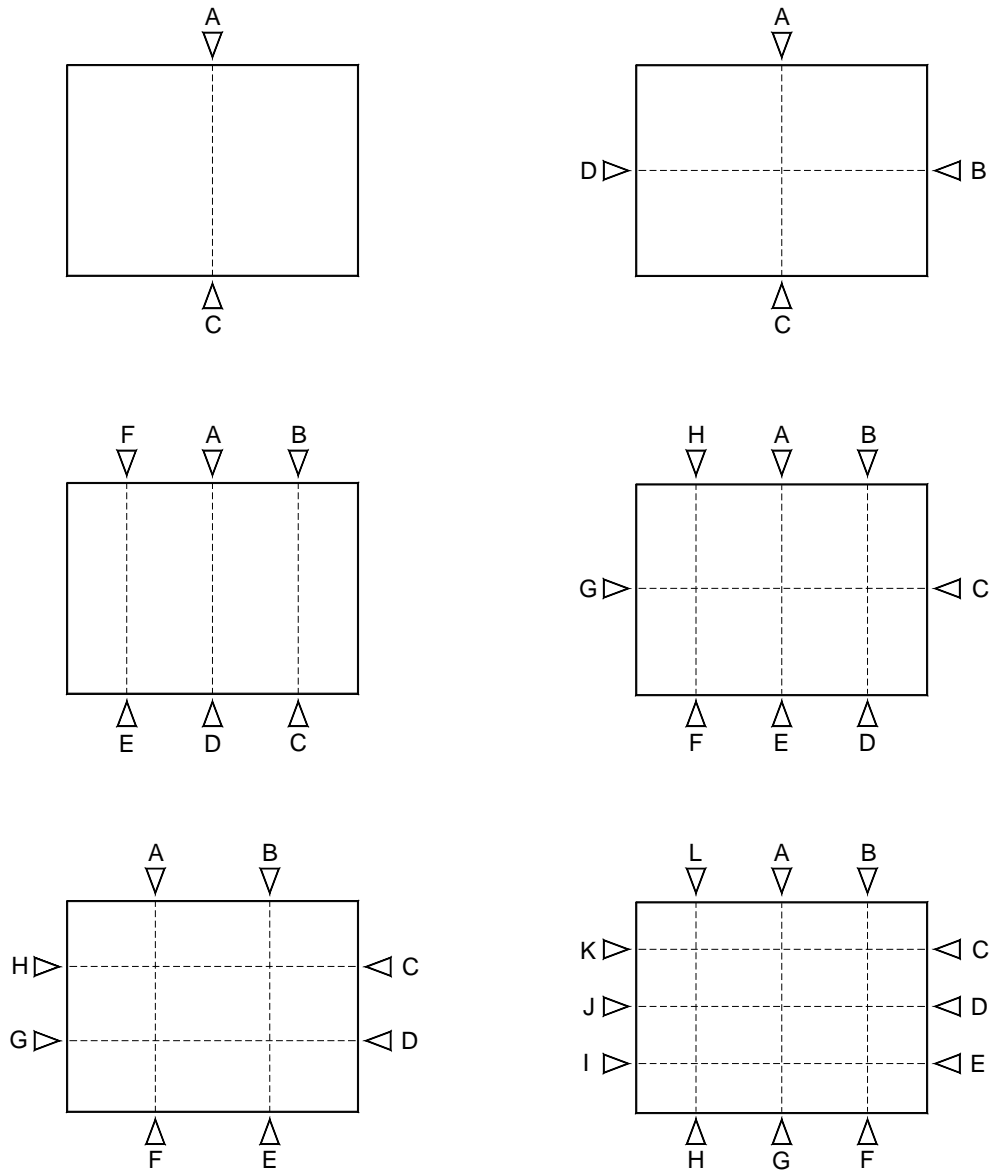


Figure 5-1 – Typical Convergence Point Array Configurations Showing Anchor Designations

**Geotechnical Analysis Report for July 2006 – June 2007**  
**DOE/WIPP-08-3177, Vol. 1**

---

Extensometer displacement rates and convergence rates are routinely plotted against time, and comparisons are made through time to identify any acceleration. Annual convergence rates are calculated by determining the difference between the first and last readings of the reporting period and dividing the difference by the time between the two readings (in years). Instruments that indicate acceleration are analyzed to determine the significance of the acceleration. Factors considered during the analysis include magnitude of the respective rates, percentage increase, convergence history, and any recent excavation in the vicinity.

Thirty-seven borehole extensometers continue to be monitored at various locations in the access drifts. Where displacement data were available, annual displacement rates were calculated for each active installation and compared to the annual displacement rates from the previous reporting period. Approximately 50 percent of the instruments are installed in the E-140 drift to monitor the waste transport route. Many of the E-140 extensometers indicate movement in the roof beam that may be attributed to shallow fracturing and the effects of anhydrite stringer separations in the roof. Lateral deformation in the roof beam may influence the extensometer readings causing an increase in the measured displacement. Although the borehole extensometer data indicate continued deformation and breakup of the lower beam, the roof bolt anchorage zone remains competent.

Further analysis of the convergence rate accelerations has shown many of them to be minor and generally related to roof beam fracturing. Other areas, such as the southern portions of the access drifts, had closure rate increases that can be directly attributed to the mining of Panel 5 and associated drifts.

Closure rates have increased in various locations by more than ten percent since the last reporting period. These locations are assessed in greater detail to determine the cause of the closure rate increase. Most of these locations are in the south access drifts near Panel 5. The increased rates were primarily observed in the W-170 and W-30 drifts. Increased closure rates were observed in E-140 from S-700 to S-1000 and from S-1300 to S-2750. They are probably caused by a combination of the effects of Panel 5 mining and continued ageing and deterioration of the roof beam.

The closure rates observed in E-140 from S-1300 to S-3080 are in an area where the roof beam has been mined to clay "G". The rate of increase in this area may be attributed to roof beam separations formed along shallow anhydrite stringers in the roof. These separations result in the formation of thin roof beams that can easily be deformed toward the opening. Tensile fractures generally develop on the roof surface in areas of maximum deformation.

The rate increases observed in other areas may be attributable to various reasons. The effect of nearby mining or significant trimming appears to have caused the rate increases in W-30 from S-90 to S-1000 and in E-140 from S-90 to N-250. Field observations in these areas do not indicate any significant deterioration that may have caused these increases.

**Geotechnical Analysis Report for July 2006 – June 2007**  
**DOE/WIPP-08-3177, Vol. 1**

**Table 5-3 – Greater than 10 Percent Increases in Annual Vertical Convergence Rates  
in the Access Drifts**

Location	Chord*	Last Reading Date	Cumulative Displacement Inches (cm.)	Closure Rate 2006 to 2007 in/yr (cm/yr)	Closure Rate 2005 to 2006 in/yr (cm/yr)	Rate Change Percent <sup>a</sup>	Comments
E0, N460	A-C	06/11/07	31.791 (80.75)	1.85 (4.70)	1.63 (4.14)	13	
E0, N626	A-C	06/11/07	50.175 (127.45)	2.04 (5.18)	1.78 (4.52)	15	
E140, N460	A-C	06/19/07	31.551 (80.14)	1.75 (4.45)	1.58 (4.01)	11	
E140, N220	A-C	06/19/07	27.548 (69.97)	2.29 (5.82)	1.41 (3.58)	62	Floor trimming.
E140, N150	A-C	06/19/07	21.068 (53.51)	2.56 (6.50)	1.05 (2.67)	144	Floor trimming.
E140, N5	A-C	06/19/07	33.677 (85.54)	2.34 (5.94)	1.24 (3.15)	89	Floor trimming.
E140, S90	A-C	05/31/07	18.871 (47.93)	1.58 (4.01)	1.13 (2.87)	40	Floor trimming.
E140, S460	A-C	05/29/07	44.064 (111.92)	2.07 (5.26)	1.75 (4.45)	18	
E140, S550	A-C	05/29/07	36.429 (92.53)	1.71 (4.34)	1.30 (3.30)	32	
E140, S1075	H-F	06/25/07	11.621 (29.52)	1.23 (3.12)	1.06 (2.69)	16	
E140, S1456	A-G	06/25/07	58.877 (149.55)	4.14 (10.52)	3.53 (8.97)	17	
E140, S1456	L-H	06/25/07	25.918 (65.83)	2.48 (6.30)	2.13 (5.41)	16	
E140, S2275	A-C	06/25/07	43.205 (109.74)	8.37 (21.26)	6.53 (16.59)	28	
E140, S2634	A-C	06/25/07	24.759 (62.89)	6.27 (15.93)	5.22 (13.26)	20	
E300, N170	H-F	06/08/07	21.038 (53.44)	1.40 (3.56)	1.26 (3.20)	11	
E300, N170	A-E	06/08/07	23.579 (59.89)	1.55 (3.94)	1.38 (3.51)	12	
E300, S45	A-E	06/08/07	19.495 (49.52)	1.15 (2.92)	1.04 (2.64)	11	
E300, S45	H-F	06/08/07	16.938 (43.02)	1.05 (2.67)	0.94 (2.39)	12	
E300, S45	B-D	06/08/07	16.093 (40.88)	1.16 (2.95)	0.95 (2.41)	22	
E300, S250	A-C	06/04/07	10.390 (26.39)	0.63 (1.60)	0.52 (1.32)	21	
E300, S850	A-E	04/09/07	13.385 (34.00)	0.48 (1.22)	0.43 (1.09)	12	
E300, S1150	A-E	04/09/07	15.015 (38.14)	0.60 (1.52)	0.53 (1.35)	13	
E300, S1150	B-D	04/09/07	10.669 (27.10)	0.42 (1.07)	0.35 (0.89)	20	
E300, S1150	H-F	04/09/07	10.235 (26.00)	0.43 (1.09)	0.36 (0.91)	19	
E300, S1450	A-C	06/04/07	6.610 (16.79)	0.71 (1.80)	0.64 (1.63)	11	
E300, S1687	A-C	06/04/07	6.919 (17.57)	0.84 (2.13)	0.76 (1.93)	11	
E300, S1775	A-C	06/04/07	6.404 (16.27)	0.71 (1.80)	0.62 (1.57)	15	
E300, S1862	A-C	06/04/07	6.781 (17.22)	0.80 (2.03)	0.71 (1.80)	13	
N140, E90	A-C	06/21/07	14.158 (35.96)	0.82 (2.08)	0.71 (1.80)	15	
N250, E220	H-F	06/08/07	19.509 (49.55)	1.47 (3.73)	1.06 (2.69)	39	Floor trimming.
N250, E220	A-E	06/08/07	25.342 (64.37)	2.37 (6.02)	1.48 (3.76)	60	Floor trimming.
S90, W400	A-C	11/29/06	14.534 (36.92)	0.74 (1.88)	0.58 (1.47)	28	
S90, W590	A-C	11/29/06	10.438 (26.51)	0.66 (1.68)	0.54 (1.37)	22	
S1300, E24	A-C	05/24/07	16.591 (42.14)	1.09 (2.77)	0.96 (2.44)	14	
S2750, E55	A-C	05/24/07	8.038 (20.42)	2.23 (5.66)	1.56 (3.96)	43	
S2750, W93	A-C	05/24/07	8.130 (20.65)	2.14 (5.44)	1.84 (4.67)	16	
S3080, E55	A-C	05/22/07	8.665 (22.01)	2.25 (5.72)	1.65 (4.19)	36	
S3080, W100	A-C	05/24/07	8.004 (20.33)	2.10 (5.33)	1.76 (4.47)	19	
S3310, E55	A-C	05/22/07	8.784 (22.31)	2.44 (6.20)	1.77 (4.50)	38	
S3310, W100	A-C	05/22/07	7.136 (18.13)	2.42 (6.15)	1.73 (4.39)	40	Nearby Panel 5 mining.
S3650, W100	A-C	05/21/07	3.261 (8.28)	2.29 (5.82)	1.51 (3.84)	52	Nearby Panel 5 mining.
W170, S850	B-D	05/14/07	12.392 (31.48)	0.58 (1.47)	0.49 (1.24)	18	

A unique letter is assigned to each convergence array element around a particular opening. Chord refers to a particular array pair.

The various array lettering schemes are shown in Figure 5-1.

<sup>a</sup> Increase in convergence rate is calculated from the difference between the 2006–2007 rate and the 2005–2006 rate.

**Geotechnical Analysis Report for July 2006 – June 2007**  
**DOE/WIPP-08-3177, Vol. 1**

**Table 5-3 – Greater than 10 Percent Increases in Annual Vertical Convergence Rates  
in the Access Drifts (Continued)**

Location	Chord <sup>*</sup>	Last Reading Date	Cumulative Displacement Inches (cm)	Closure Rate 2006 to 2007 in/yr (cm/yr)	Closure Rate 2005 to 2006 in/yr (cm/yr)	Rate Change Percent <sup>a</sup>	Comments
W170, S850	H-F	05/14/07	11.333 (28.79)	0.51 (1.30)	0.43 (1.09)	19	
W170, S850	A-E	05/14/07	16.545 (42.02)	0.71 (1.80)	0.59 (1.50)	20	
W170, S1150	H-F	05/14/07	12.996 (33.01)	0.63 (1.60)	0.40 (1.02)	58	
W170, S1950	A-C	05/14/07	12.518 (31.80)	0.84 (2.13)	0.71 (1.80)	18	
W170, S2685	A-C	05/17/07	11.078 (28.14)	2.77 (7.04)	2.33 (5.92)	19	
W170, S2833	A-C	05/14/07	6.796 (17.26)	1.67 (4.24)	1.44 (3.66)	16	
W170, S2998	A-C	05/14/07	9.185 (23.33)	2.60 (6.60)	1.91 (4.85)	36	
W170, S3080	A-C	05/14/07	7.058 (17.93)	1.66 (4.22)	1.48 (3.76)	12	
W170, S3195	A-C	05/14/07	7.716 (19.60)	2.03 (5.16)	1.40 (3.56)	45	Nearby Panel 5 mining.
W170, S3310	A-C	05/14/07	8.644 (21.96)	3.52 (8.94)	1.38 (3.51)	155	Nearby Panel 5 mining.
W170, S3395	A-C	05/15/07	3.736 (9.49)	2.61 (6.63)	1.59 (4.04)	64	Nearby Panel 5 mining.
W170, S3480	A-C	05/15/07	4.110 (10.44)	2.91 (7.39)	1.73 (4.39)	68	Nearby Panel 5 mining.
W170, S3565	A-C	05/15/07	3.544 (9.00)	2.39 (6.07)	1.51 (3.84)	58	Nearby Panel 5 mining.
W170, S3650	A-C	05/21/07	4.680 (11.89)	3.22 (8.18)	1.21 (3.07)	166	Nearby Panel 5 mining.
W30, S120	A-C	06/11/07	20.687 (52.55)	1.13 (2.87)	0.88 (2.24)	28	Floor trimming.
W30, S250	A-C	06/11/07	26.835 (68.16)	1.30 (3.30)	0.84 (2.13)	55	Floor trimming.
W30, S400	A-C	06/11/07	18.383 (46.69)	1.04 (2.64)	0.73 (1.85)	42	Floor trimming.
W30, S500	A-C	06/11/07	23.164 (58.84)	1.23 (3.12)	0.73 (1.85)	68	Floor trimming.
W30, S700	A-C	06/11/07	30.182 (76.66)	1.68 (4.27)	0.86 (2.18)	95	Floor trimming.
W30, S850	A-E	06/11/07	17.903 (45.47)	0.98 (2.49)	0.58 (1.47)	69	Floor trimming.
W30, S850	B-D	06/11/07	12.229 (31.06)	0.73 (1.85)	0.38 (0.97)	92	Floor trimming.
W30, S850	H-F	06/11/07	13.351 (33.91)	0.78 (1.98)	0.39 (0.99)	100	Floor trimming.
W30, S1000	A-C	06/11/07	34.606 (87.90)	1.44 (3.66)	1.11 (2.82)	30	
W30, S1100	A-C	06/12/07	11.061 (28.10)	0.97 (2.46)	0.84 (2.13)	15	
W30, S1300	A-C	06/12/07	18.743 (47.61)	1.22 (3.10)	1.01 (2.57)	21	
W30, S1453	A-C	06/12/07	13.053 (33.16)	0.92 (2.34)	0.78 (1.98)	18	
W30, S1600	A-C	06/12/07	17.000 (43.18)	1.08 (2.74)	0.93 (2.36)	16	
W30, S1775	A-C	06/12/07	9.540 (24.23)	0.64 (1.63)	0.55 (1.40)	16	
W30, S1950	A-C	06/12/07	16.396 (41.65)	1.07 (2.72)	0.95 (2.41)	13	
W30, S2067	A-C	06/12/07	12.826 (32.58)	0.97 (2.46)	0.85 (2.16)	14	
W30, S2275	A-C	06/12/07	7.540 (19.15)	0.97 (2.46)	0.87 (2.21)	11	
W30, S2425	A-C	06/12/07	8.767 (22.27)	1.10 (2.79)	0.97 (2.46)	13	
W30, S2520	A-C	06/12/07	13.544 (34.40)	1.55 (3.94)	1.40 (3.56)	11	
W30, S2685	A-C	06/12/07	12.598 (32.00)	1.87 (4.75)	1.68 (4.27)	11	
W30, S2833	A-C	06/12/07	6.933 (17.61)	1.62 (4.11)	1.42 (3.61)	14	
W30, S2916	A-C	06/12/07	10.678 (27.12)	3.13 (7.95)	2.29 (5.82)	37	
W30, S2998	A-C	06/12/07	6.665 (16.93)	1.47 (3.73)	1.31 (3.33)	12	
W30, S3080	A-C	06/12/07	12.062 (30.64)	2.48 (6.30)	2.19 (5.56)	13	
W30, S3195	A-C	06/12/07	7.890 (20.04)	1.92 (4.88)	1.53 (3.89)	25	
W30, S3310	A-C	06/12/07	8.392 (21.32)	1.75 (4.45)	1.55 (3.94)	13	
W30, S3395	A-C	06/12/07	3.911 (9.93)	1.96 (4.98)	1.69 (4.29)	16	
W30, S3480	A-C	06/12/07	4.045 (10.27)	2.04 (5.18)	1.74 (4.42)	17	
W30, S3565	A-C	06/12/07	3.558 (9.04)	1.78 (4.52)	1.54 (3.91)	16	
W30, S3650	A-C	05/21/07	3.087 (7.84)	2.00 (5.08)	1.59 (4.04)	26	

A unique letter is assigned to each convergence array element around a particular opening. Chord refers to a particular array pair.

The various array lettering schemes are shown in Figure 5-1.

<sup>a</sup> Increase in convergence rate is calculated from the difference between the 2006–2007 rate and the 2005–2006 rate.

#### **5.4 Excavation Performance**

Approximately 500 readings are collected and assessed regularly from convergence point arrays throughout the WIPP underground. Convergence rates continue to vary seasonally, typically increasing during the warmer and more humid summer months and decreasing during the cooler and drier winter months.

The performance of the access drift excavations during this reporting period was within acceptable criteria. "Acceptable criteria" means that a drift remains accessible, and the ground can be controlled by routine maintenance. Standard remedial ground control in some areas was required to maintain the performance of the excavations. The drifts remain stable and controlled. Most of the annualized rates remain steady, indicating stability. In some locations, where the rates are high, nearby mining activity is most likely the cause. In other locations, where necessary, additional ground control measures have been or will be installed.



## **6.0 PERFORMANCE OF WASTE DISPOSAL AREA**

The Waste Disposal Area as of June 30, 2007, consists of Panels 1, 2, 3, and 4. Panels 1 and 2 were closed during previous reporting periods. Waste disposal in Panel 3 was completed in this period. Substantial barriers and bulkheads were installed in the exhaust and intake drifts to prevent access into the panel and to isolate this panel from the ventilation circuit. Waste is being disposed of in Panel 4. Panel 5 is being mined as shown in Figure 1-2.

### **6.1 History**

Excavation of Panel 1 began in May 1986 with the mining of the access entries. Initially, the disposal rooms and drifts were developed as pilot drifts that were later excavated to nominal operational dimensions of 13 ft (4 m) high, 33 ft (10 m) wide, and 300 ft (91 m) long. Room 1 was completed to these dimensions in August 1986, and pilot drifts for Rooms 2 and 3 were excavated in January and February 1987. Rooms 2 and 3 were completed in February and March 1988, and Rooms 4 through 7 were completed in May 1988. Four short access drifts designed to lead to smaller test alcoves were excavated north off the S-1600 drift and Rooms 4-7 in June 1989. Only the access drifts to the alcoves were completed; the alcoves themselves were not excavated. Panel 1 waste emplacement (in Rooms 1, 2, 3, 7, adjacent areas of S-1600, and all of S-1950) is complete, and the panel is closed to all access. The Panel 1 access entries, S-1600 and S-1950, which extend from the E-300 drift to the isolation walls, remain open, and the instrumentation in this area will continue to be maintained and monitored.

Excavation of the Panel 2 waste disposal area began in September 1999 with the mining of access entries. Initially, the disposal rooms and drifts were developed as pilot drifts that were trimmed to finished dimensions. Room 1 was completed in January 2000, and pilot drifts for Rooms 2 and 3 were excavated in February 2000. Pilot drifts were completed for Rooms 4 through 6 in April 2000. The pilot drift for Room 7 was excavated in May 2000. All the rooms were excavated to final dimensions by August 2000. Waste emplacement in Panel 2 was completed during a prior reporting period, and the panel is closed to all access. The Panel 2 access entries, S-2150 and S-2520, which extend from the E-300 drift to the isolation walls, remain open, and the instrumentation in this area will continue to be maintained and monitored.

Excavation of Panel 3 waste disposal rooms began in May 2002 with the mining of access entries to Panel 3. As with Panel 2, initially, the disposal rooms and drifts were developed as pilot drifts that were trimmed to finished dimensions. All the rooms were excavated to final dimensions by the end of March 2004. Waste emplacement in Panel 3 was completed in February 2007.

Panel 4 access drift mining began in January 2005. The disposal rooms were initially developed as pilot drifts and were later trimmed to final dimensions. Mining was completed by June 2006. Waste has been emplaced in Room 7, and emplacement continues in Room 6. Panel 5 mining started and is continuing.

## **6.2 Modifications to Excavations and Ground Control Activities**

There were no new excavations associated with Panels 1 through 4 during the reporting period. Waste disposal in Panel 3 was completed, and substantial and isolation barriers were installed in the access drifts. Mining of Panel 5 was started but not completed. Routine maintenance and ground control activities in the form of trimming, scaling, rock bolt replacement, and installing wire mesh were performed on ribs, floor, and roof throughout accessible areas of the disposal panels. Supplemental bolts were installed in Room 4 and the S-3310 drift between Rooms 1 and 3. RH holes were drilled horizontally into the ribs of Rooms 6, 5, and 4 for RH canister disposal. RH waste was emplaced in Rooms 6 and 5. Table 6-1 summarizes the ground control activities performed in the disposal panels during this reporting period.

## **6.3 Instrumentation**

There were no changes to the Panel 3 instrumentation layout. Monitoring of manually read instruments continued until access was no longer available due to waste disposal. Remote monitoring of the borehole extensometers continued through this reporting period.

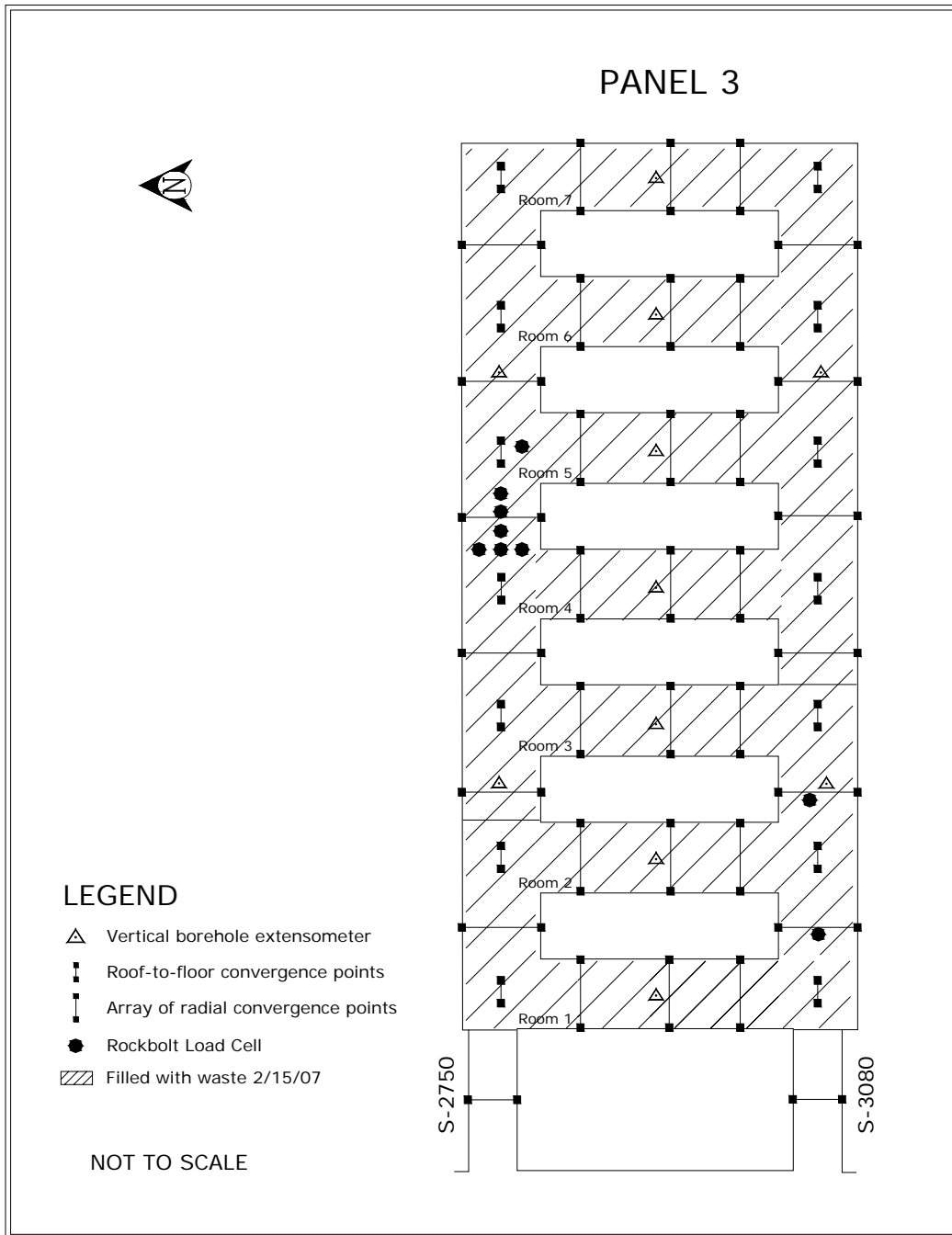
The instrumentation of Panel 4 was completed. Convergence points were installed in all of the disposal rooms, intersections, and at mid-pillar locations in the access drifts. A borehole extensometer was installed in the roof at each room center. Roof bolt load cells were installed at the center of each room and at selected locations in S-3310 and S-3650.

Instrumentation of the newly mined areas of Panel 5 was initiated during this reporting period. Extensometers were installed in the roof of Rooms 1 and 2.

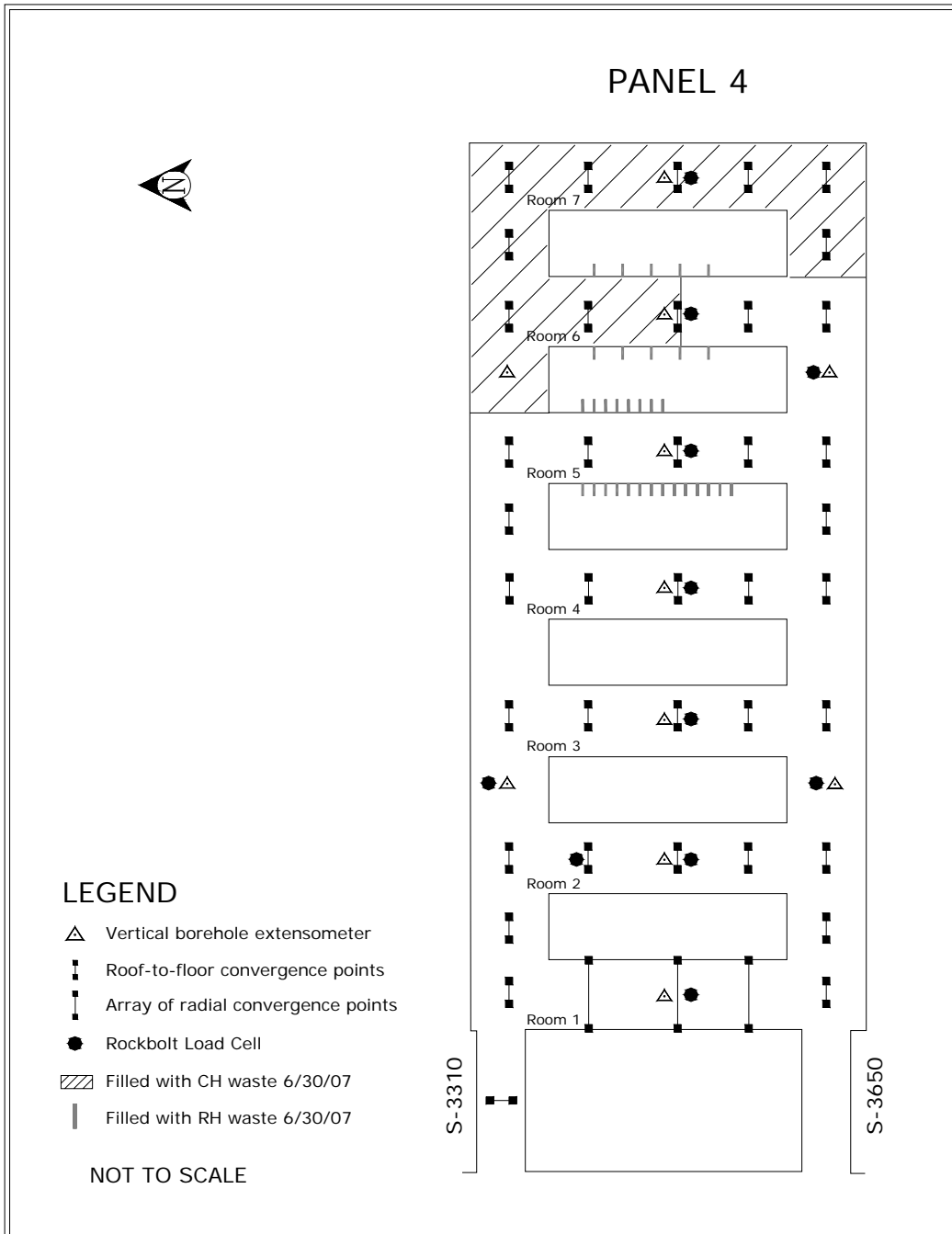
Schematics of the geotechnical instrumentation layout in Panels 3, 4, and 5 are shown in Figures 6-1 through 6-3.

**Table 6-1 – Summary of Modifications and Ground Control Activities in the Waste Disposal Area from July 1, 2006, to June 30, 2007**

<b>Location</b>	<b>Work Performed</b>
Panel 3 entries, S-2750 and S-3080	Ceased waste disposal in panel. Installed substantial and isolation barriers in access drifts.
Panel 4, Room 4	Installed supplemental ground support.
Panel 4, S-3310 between Rooms 1 and 3	Installed supplemental ground support.
Panel 4, all rooms	Installed chain link and mesh along the roof/rib line
Panel 4, Room 1	Trimmed drummy ground on west rib and installed bolts and chain link.



**Figure 6-1 – Location of Panel 3 Geotechnical Instruments**



**Figure 6-2 – Location of Panel 4 Geotechnical Instruments**

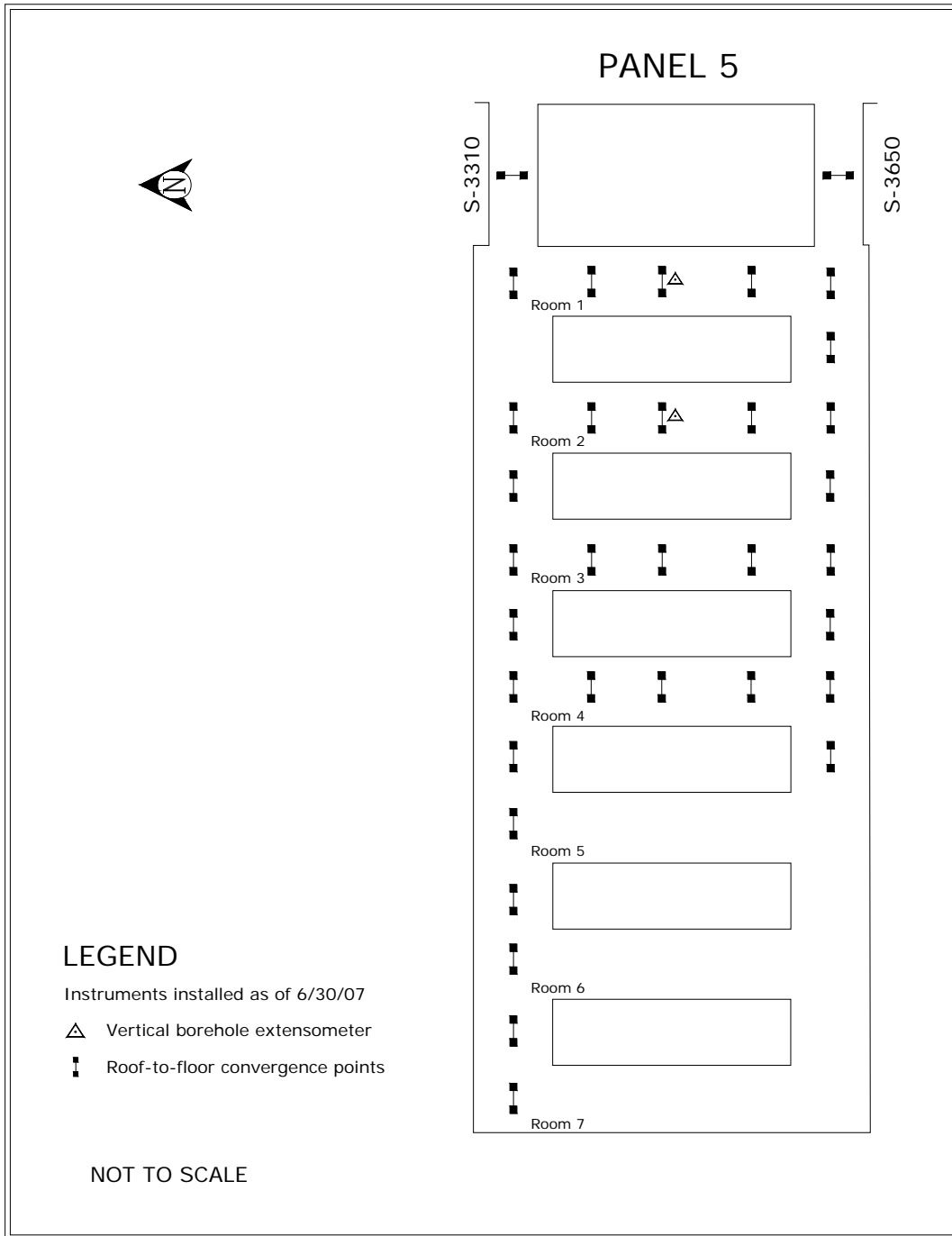


Figure 6-3 – Location of Panel 5 Geotechnical Instruments

#### 6.4 Excavation Performance

Waste handling activities in Panels 1 and 2 have been completed, and geotechnical monitoring inside these panels has been discontinued. Waste handling activities have also been completed in Panel 3; however, extensometers continue to be read remotely. In accessible underground areas, horizontal and vertical convergence rates, calculated at the center of each of the rooms, were compared between this and the previous

reporting period. Generally, the convergence rates have decreased or remained similar. Increased rates observed in some areas are usually associated with areas of roof beam separation and fracturing. Geomechanical monitoring indicates that the early installation of a rigid threaded bar support system in Panel 4 has reduced the generation of shallow roof beam separations below that observed in Panel 3.

Convergence monitoring in the panel entries does not indicate an acceleration of closure rates; however, fracturing of the roof beam continues. It is anticipated that routine ground control maintenance will be sufficient to maintain access to these areas.

### **6.5 Analysis of Extensometer and Convergence Point Data**

Borehole extensometers are installed in the roof at the center of each disposal room and at select locations in the panel access drifts. They show a general decrease in the rate of roof beam deformation. Supplemental ground control support was installed in these areas and has subsequently reduced the observed rates.

Although Panels 1, 2, and 3 are closed, convergence monitoring continues in the panel entries between E-300 and the explosion isolation walls (Panels 1 and 2) and substantial and isolation barriers (Panel 3). The monitoring results indicate a steady long-term trend. The lowest closure rates were observed nearest to the rigid masonry walls. Geotechnical monitoring in Panel 3 indicates continued deformation and deteriorating ground conditions.

Convergence rates in Panel 4 are generally decreasing or approaching steady state. The initial effects due to mining decreased significantly, similar to the experience in previous panels. The number and continuity of these stringers vary; however, the stringers are commonly observed throughout the panel. Deformation rates in these areas have stabilized or decreased in response to the installation of ground control.

Panel 5 mining continues with the installation of pattern bolts soon after mining. Panel 5 is being bolted and monitored at an even earlier stage in its development than were Panels 3 and 4. It appears from early observations that the closure rates are trending to be lower than those observed in Panel 4.

## **7.0 GEOSCIENCE PROGRAM**

The Geoscience Program confirms the suitability of the site through the collection of various geologic data and excavation characteristics from the underground. These include the inspection of open boreholes for fractures (separations) and offsets (lateral displacements) in roof beams and the mapping of fracture development on roof surfaces. Data collected through these activities support the design and evaluation of ground support systems.

During this reporting period, the following activities were performed:

- Borehole Inspections
- Fracture Mapping

Fracture development in the roof is primarily caused by the concentration of compressive stresses in the roof beam and is influenced by the size and shape of the excavation and the stratigraphy in the immediate vicinity of the opening. In a thick roof beam, pillar deformations induce lateral compressive stresses into the immediate roof and floor. With time, the buildup of stress causes differential movement along stratigraphic boundaries. This differential movement is identified as offsets in observation boreholes and by the bends in failed rock bolts. Large strains associated with lateral movements can induce fracturing in the roof, which is frequently seen near the ribs; however, this process may take a long time (years) to develop.

At the upper repository horizon, clay or anhydrite stringers exert significant influence over the effective thickness of the roof beam. The presence of these stringers causes the roof beam to behave as a series of thin independent beams. Little or no tensile support is provided across the stringer interface. As horizontal end-loading continues, each beam can deflect downward causing a tensile fracture to develop along the bottom of the beam. These tensile fractures can develop in relatively new excavations soon after separation occurs along the stringer interface.

The location and initiation of interface separation is also influenced by the dip of the rock layers. The roofs and floors of the disposal panels are mined level through the sloping beds. At some locations, this may result in a significant difference in roof beam thickness from one side of the excavation to the other. Areas with the thinnest beam are the most likely to develop separations and subsequent fracturing.

### **7.1 Borehole Inspections**

Geotechnical observation boreholes are drilled at various locations throughout the underground facility. A location may contain one or more boreholes arranged in an array. These holes are drilled to depths that allow the monitoring of fracture development and offsetting and are inspected for the development of those features. Roof observation holes usually extend up past clays "G" and "H" (Figures 7-1 and 7-2).

The clay seams nearest the excavation surfaces define the immediate roof beam. The roof beam is bounded by clay "G" in most of the access drifts and Panels 1 and 2.

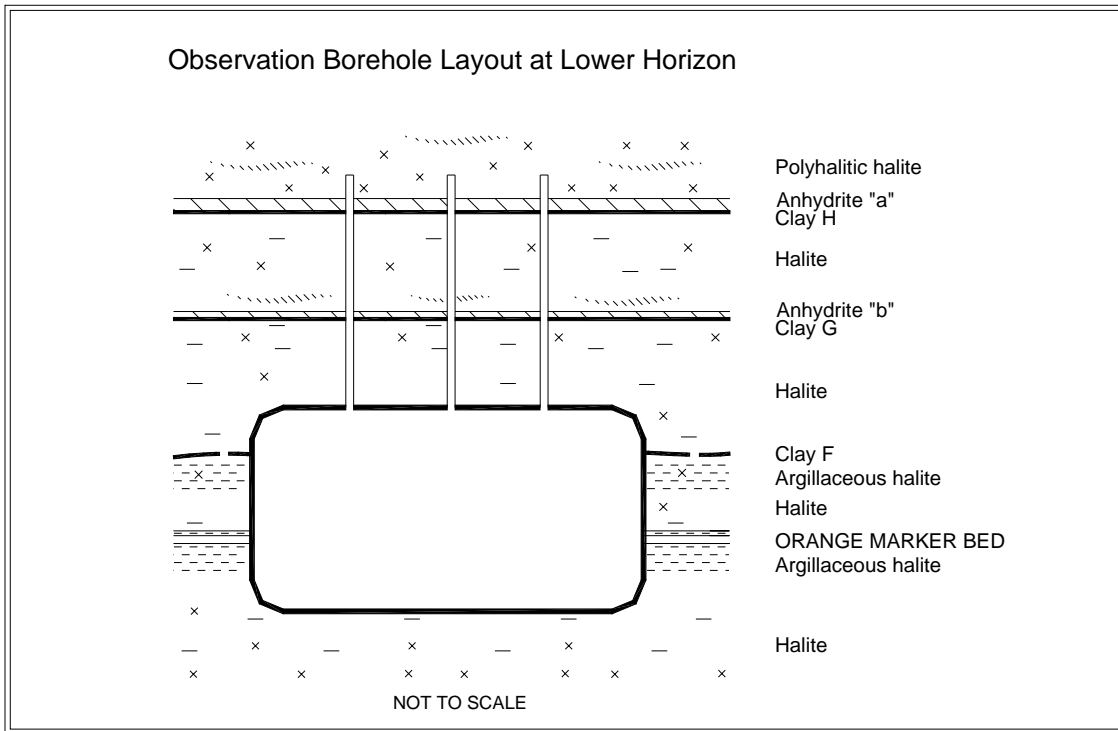
**Geotechnical Analysis Report for July 2006 – June 2007**  
**DOE/WIPP-08-3177, Vol. 1**

---

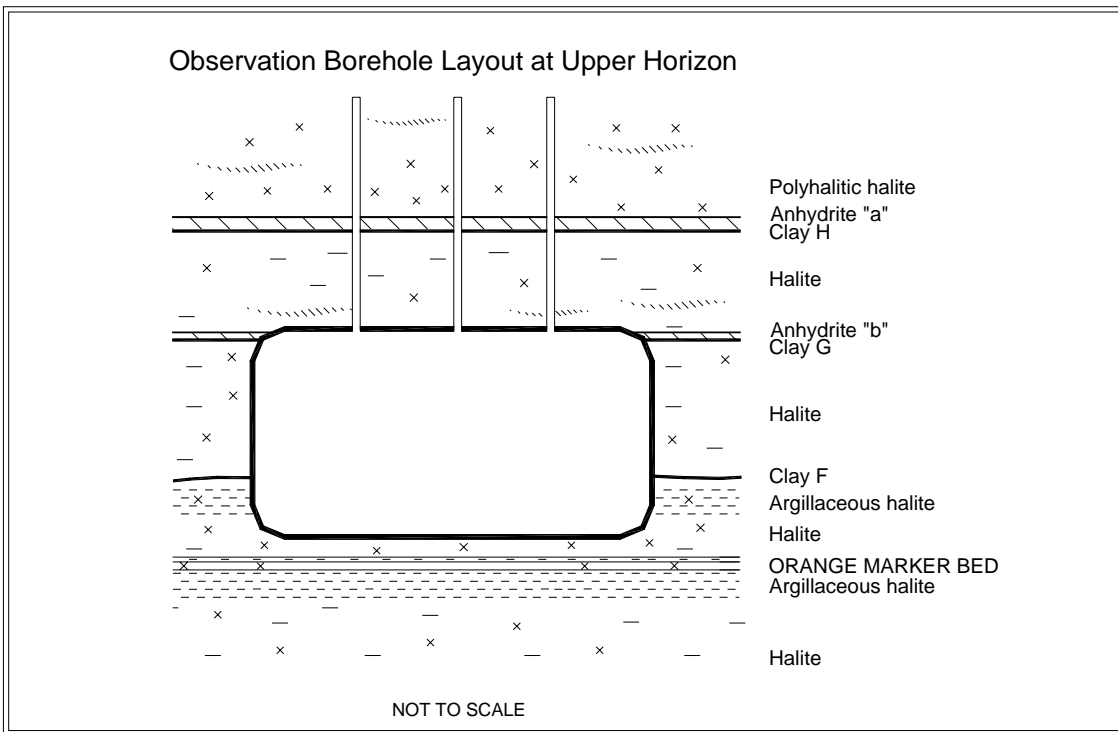
Some areas, such as the Salt Shaft Station, portions of the E-0 and E-140 drifts, the south mains south of S-2620, and Panels 3, 4, and 5 are excavated to clay "G" and so have roof beams bounded by clay "H".

The offset in a borehole is determined by visually estimating the degree of borehole occlusion. The direction of offset along clay seams is observed as the movement of the strata nearer to the observer relative to the strata farther away. Typically, the nearer strata move toward the center of the excavation (Figures 7-3 and 7-4). Based on previous observations in the underground, the magnitude of offset is usually greater in boreholes located near ribs than in those located along excavation centerlines. Offsetting along the clay layers is observable until the total borehole offset is reached or visibility is obstructed by intervening offsets at other clay seams or fractures. Boreholes are inspected for fractures, using an aluminum rod with a flattened steel wire probe attached to one end perpendicular to the rod (referred to as a "scratcher rod"). Fractures and clay seams are located by moving the probe along the inside of the borehole until it is snagged in one of these features. Depth to each feature is recorded, as is the magnitude of separations encountered. In addition, during this reporting period, the use of a borehole camera has been introduced in conjunction with the scratch rod.

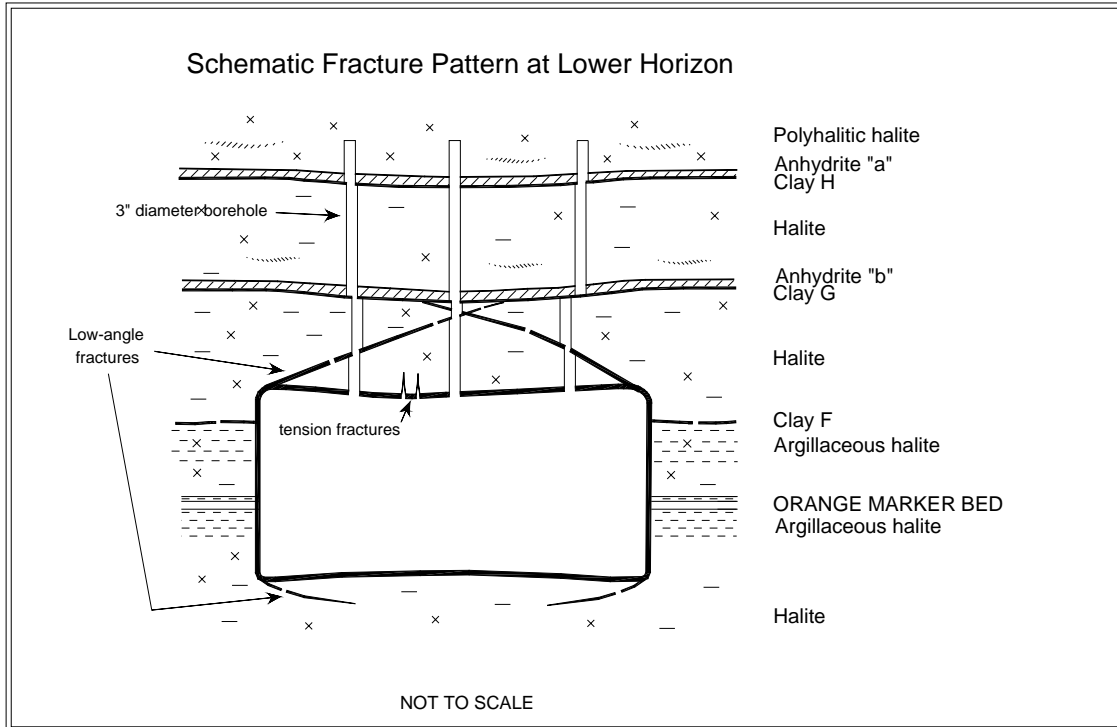




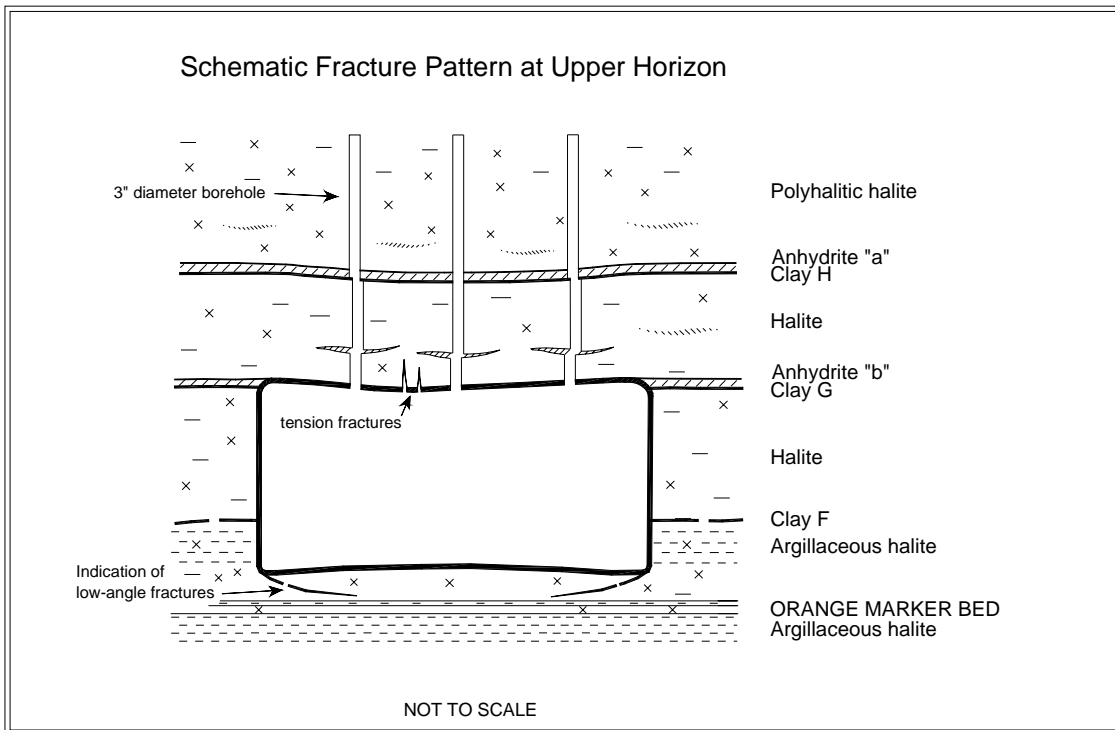
**Figure 7-1 – Example of Observation Borehole Layout at Lower Horizon**



**Figure 7-2 – Example of Observation Borehole Layout at Upper Horizon**



**Figure 7-3 – Typical Fracture Patterns at Lower Horizon**



**Figure 7-4 – Typical Fracture Patterns at Upper Horizon**

The separation and offset data observed in accessible holes in the back are presented in the supporting data document for this report. Forty-eight holes in Panel 4 and 41 in Panel 5 had been drilled at the time of this report. In both Panels 4 and 5, the greatest separations were associated with clay "H" and anhydrite "a". Eight holes in Panel 4 and three holes in Panel 5 had fractures associated with anhydrite stringers in the lower portion (first 3 feet) of the roof beam. Thirty-seven of the 48 holes in Panel 4 and two of the 41 holes in Panel 5 showed some offset.

## **7.2 Fracture Mapping**

Routine mapping documents the progression of fractures in the roof exposed on the excavation surfaces of the drifts and rooms in the underground repository. The fracture surveys are generally performed on an annual basis, and the fracture maps are updated. The fracture maps facilitate the analysis of strain in the immediate roof-beam because they document the development and propagation of fractures through time. The supporting data document contains fracture maps for Panels 4 and 5. For this reporting period, fracture maps include Panel 4, Rooms 1 through 7 and the S-3310 and S-3650 drifts, and Panel 5, Room 1.

This page intentionally left blank

## **8.0 SUMMARY**

At the inception of WIPP, criteria were developed that address the design requirements (DOE, 1984). They pertain to all aspects of the mined facility and its operation as a pilot plant for the demonstration of technical and operational methods for permanent disposal of contact-handled and remote-handled TRU waste. In 1994, as the WIPP focus moved toward the permanent disposal of TRU waste, these design requirements were reassessed and replaced by a new set of requirements called system design descriptions. Table 8-1 shows the comparison of these design requirements with conditions actually observed in the underground from July 2006 through June 2007.

Normal drift and room maintenance continued during this reporting period with rib, roof, and floor scaling and trimming in various locations, and rock bolts and wire mesh installed as needed. Supplemental ground control systems consisting of resin-anchored bolts were installed in select locations in the E-140 and W-170 drift and the E-300 shop area. Some of these supplemental systems also included roof mats.

New geomechanical instrumentation was installed in Panel 5 and its access drifts, as well as in various locations throughout the repository to replace mined-out instruments. Monitoring no longer continues in non-accessible areas except in Panel 3 and closed rooms in Panel 4. All accessible areas of the underground are connected to data-loggers or are monitored manually.

The *in situ* performance of the excavations generally continues to satisfy the appropriate design criteria, although specific areas are being identified where deterioration resulting from ageing must be addressed through routine maintenance and installation of engineered systems. This deterioration has been identified through the analysis of data acquired from geomechanical instrumentation and the Geoscience Program. If the planned life of some of the openings needs to be extended, changing the geometry of the access drifts (removing unstable roof beam or rib spalls, or milling the floor for added clearance), or additional ground control (roof removal, installing bolts, mesh, or straps) may be necessary. The ground conditions in the waste disposal area and associated waste transport routes continue to slowly deteriorate; however, routine ground control installations and maintenance continue to allow safe access in the underground facility.

In addition to underground instrumentation, qualitative assessments of fracture development are documented through mapping the underground repository and inspecting the observation boreholes. The information acquired from these programs provides early detection of ground deterioration, contributes to the understanding of the dynamic geomechanical processes in the WIPP underground, and aids in the design of effective ground control and support systems.

**Geotechnical Analysis Report for July 2006 – June 2007**  
**DOE/WIPP-08-3177, Vol. 1**

**Table 8-1 – Comparison of Excavation Performance to System Design Requirements**

Requirement	Comments
"The lining shall be designed for a hydrostatic pressure. . . ."	Water pressure observed on piezometers located behind the shaft liners remains below design levels.
"The key shall be designed to resist the lateral pressure generated by salt creep."	Geomechanical data from the Waste Shaft indicate that the shaft key is minimally loaded and is structurally stable. Visual inspections of all shaft keys do not indicate any deterioration due to creep loading.
"The key shall be designed to retain the rock formation and will be provided with chemical seal rings and a water collection ring with drains to prevent water from flowing down the unlined shaft from the lining above."	Shaft inspection observations and instrumentation show no indication of instability due to salt dissolution. No water has been observed flowing along the rock-liner interface.
"The underground waste disposal facilities shall be designed to provide space and adequate access for the underground equipment and temporary storage space to support underground operations."	Geomechanical instrument data and visual observations indicate that the current design provides adequate access and storage and disposal space. Ground control maintenance is performed as necessary to maintain access.
"Entries and subentries to the underground disposal area and the experimental areas shall be provided and sized for personnel safety, adequate air flow, and space for equipment."	Deformation of excavation remains within the required limits. Normal periodic maintenance consisting of rock bolting, wire meshing, trimming, and scaling continue throughout the repository. The former experimental area, consisting of the Northeast and Northwest Areas, is now deactivated and closed to access.
"Geomechanical instrumentation shall be provided to measure the cumulative deformation of the rock mass surrounding mined drifts. . . ."	Geotechnical instrumentation is operated and maintained to meet this requirement. This annual report provides a summary and analysis of the geomechanical data.

## **9.0 REFERENCES**

ASTM, 2006, E29-06b, *Standard Practice for Using Significant Digits in Test Data to Determine Conformance with Specifications*.

DOE, see U.S. Department of Energy.

Public Law 96-164, Department of Energy National Security and Military Applications of Nuclear Energy Authorization Act of 1980.

Title 40 CFR Part 191, "Environmental Radiation Protection Standards for Management and Disposal of Spent Nuclear Fuel, High-Level and Transuranic Radioactive Wastes."

Title 40 CFR Part 194, "Criteria for the Certification and Re-certification of the Waste Isolation Pilot Plant's Compliance with the 40 CFR Part 191 Disposal Regulations."

U.S. Environmental Protection Agency, 1998, "Criteria for the Certification and Recertification of the Waste Isolation Pilot Plant's Compliance with the Disposal Regulations: Certification Decision," *Federal Register*, Vol. 63, No. 95, pp. 27354, May 18, 1998, Washington, DC

Holt, R. M., and D. W. Powers, 1990, *Geologic Mapping of the Air Intake Shaft at the Waste Isolation Pilot Plant*, DOE/WIPP 90-051, Waste Isolation Pilot Plant, Carlsbad, New Mexico.

Holt, R. M., and D. W. Powers, 1984, *Geotechnical Activities in the Waste Handling Shaft, Waste Isolation Pilot Plant (WIPP) Project, Southeastern New Mexico*, WTSD-TME 038, Waste Isolation Pilot Plant, Carlsbad, New Mexico.

New Mexico Environment Department (NMED), 2006, Waste Isolation Pilot Plant Hazardous Waste Facility Permit, NM4890139088-TSDF, Santa Fe, New Mexico.

Powers, D. W., and R. M. Holt, 1993, *The Upper Cenozoic Gatuña Formation of Southeastern New Mexico*, New Mexico Geological Society Guidebook, 44th Field Conference, Carlsbad Region, New Mexico and West Texas, D. W. Love et al., Eds., pp 271–282.

Powers, D. W., and R. M. Holt, 1995, *Gatuña Formation (Miocene to Pleistocene) Geology and Paleohydrology*, prepared for Westinghouse Waste Isolation Division by International Technology Corporation, Albuquerque, New Mexico.

Powers, D. W., S. J. Lambert, S. E. Shaffer, L. R. Hill, and W. D. Weart, Eds., 1978, *Geological Characterization Report, Waste Isolation Pilot Plant (WIPP) Site, Southeastern New Mexico*, Vols. I and II, SAND 78-1596; Sandia National Laboratories, Albuquerque, New Mexico.

**Geotechnical Analysis Report for July 2006 – June 2007**  
**DOE/WIPP-08-3177, Vol. 1**

---

U.S. Department of Energy (DOE), 2000, *Brine Generation Study*, DOE/WIPP 00-2000, Waste Isolation Pilot Plant, Carlsbad, New Mexico.

U.S. Department of Energy (DOE), 1986a, *Interim Geotechnical Field Data Report*, DOE/WIPP 86-012, Waste Isolation Pilot Plant, Carlsbad, New Mexico.

U.S. Department of Energy (DOE), 1986b, *Waste Isolation Pilot Plant Design Validation Final Report*, DOE/WIPP 86-010; Prepared by Bechtel National, Inc., for the U.S. Department of Energy, San Francisco, California.

U.S. Department of Energy (DOE), 1986c, *Geotechnical Activities in the Exhaust Shaft*, DOE/WIPP 86-008, Waste Isolation Pilot Plant, Carlsbad, New Mexico.

U.S. Department of Energy (DOE), 1985, *Quarterly Geotechnical Field Data Report*, DOE/WIPP-221, Waste Isolation Pilot Plant, Carlsbad, New Mexico.

U.S. Department of Energy (DOE), 1984, *Design Criteria, Waste Isolation Pilot Plant (WIPP) Revised Mission Concept-IIA*, DOE/WIPP-071; Waste Isolation Pilot Plant, Carlsbad, New Mexico.

U.S. Department of Energy (DOE), 1983, *Summary of the Results of the Evaluation of the WIPP Site and Preliminary Design Validation Program*, DOE/WIPP-161; Waste Isolation Pilot Plant, Carlsbad, New Mexico.



**Geotechnical Analysis  
Report  
for  
July 2006 - June 2007  
  
Supporting Data**

March 2008



Waste Isolation Pilot Plant

## ***Table of Contents***

---

List of Tables .....	ii
List of Figures .....	iii
1.0 Introduction.....	1-1
1.1 Instrumentation .....	1-1
1.2 Data Plot Explanation .....	1-2
1.3 Report Organization.....	1-2
2.0 Instrumentation Summary for Shafts .....	2-1
3.0 Instrumentation Summary for Shaft Stations.....	3-1
4.0 Instrumentation Summary for the Access Drifts .....	4-1
5.0 Instrumentation Summary for the Waste Disposal Area .....	5-1
6.0 Geoscience Program Supporting Data .....	6-1
6.1 Borehole Inspections.....	6-1
6.2 Fracture Mapping.....	6-1

## ***List of Tables***

---

<b>Table</b>	<b>Title</b>	<b>Page No.</b>
2-1	Salt Handling Shaft Data Analysis.....	2-2
2-2	Waste Shaft Data Analysis.....	2-11
2-3	Exhaust Shaft Data Analysis.....	2-16
3-1	Salt Handling Shaft Station Data Analysis.....	3-2
3-2	Waste Shaft Station Data Analysis.....	3-5
3-3	Air Intake Shaft Station Data Analysis.....	3-11
4-1	Access Drifts Data Analysis.....	4-2
5-1	Panel 1 Access Drifts Data Analysis.....	5-2
5-2	Panel 2 Access Drifts Data Analysis.....	5-11
5-3	Panel 3 Data Analysis.....	5-13
5-4	Panel 4 Data Analysis.....	5-29
5-5	Panel 5 Data Analysis.....	5-69
6-1	Observation Borehole Fractures and Offset Data Summary.....	6-2

## List of Figures

---

Figure	Title	Page No.
Shafts and Keys		
Salt Handling Shaft		
2-1	Piezometers 37X-PE-00201 and 37X-PE-00202 Salt Handling Shaft – Level 580 at the Forty-niner Member .....	2-4
2-2	Piezometers 37X-PE-00203 and 37X-PE-00204 Salt Handling Shaft – Level 620 at the Magenta Dolomite Member .....	2-4
2-3	Piezometers 37X-PE-00205 and 37X-PE-00206 Salt Handling Shaft – Level 691 at the Tamarisk Member .....	2-5
2-4	Piezometers 37X-PE-00207 Salt Handling Shaft – Level 726 at the Culebra Dolomite Member .....	2-5
2-5	Piezometers 37X-PE-00209 and 37X-PE-00210 Salt Handling Shaft – Level 802 at the Los Medaños Member.....	2-6
2-6	Piezometers 37X-PE-00211 and 37X-PE-00212 Salt Handling Shaft – Level 850 at the Rustler-Salado Contact.....	2-6
2-7	Earth Pressure Cells Behind Shaft Key Salt Handling Shaft Key – Level 860 .....	2-7
2-8	Spot-Welded Strain Gages Salt Handling Shaft Key – Level 856.3.....	2-7
2-9	Spot-Welded Strain Gages Salt Handling Shaft Key – Level 862.4.....	2-8
2-10	Embedment Strain Gages Salt Handling Shaft Key – Level 856.3 .....	2-8
2-11	Embedment Strain Gages Salt Handling Shaft Key – Level 862.4 .....	2-9
2-12	Embedment Strain Gages Salt Handling Shaft Key – Level 856.3 .....	2-9
2-13	Embedment Strain Gages Salt Handling Shaft Key – Level 862.4 .....	2-10
Waste Shaft		
2-14	Piezometer 31X-PE-00202 Waste Shaft – Level 532 at the Base of Dewey Lake Redbeds .....	2-12
2-15	Piezometers 31X-PE-00203 and 31X-PE-00204 Waste Shaft – Level 611 at the Magenta Dolomite Member.....	2-12
2-16	Piezometers 31X-PE-00205 and 31X-PE-00206 Waste Shaft – Level 669 at the Tamarisk Member .....	2-13
2-17	Piezometer 31X-PE-00208 Waste Shaft – Level 717 at the Culebra Dolomite Member .....	2-13
2-18	Piezometers 31X-PE-00209 and 31X-PE-00210 Waste Shaft – Level 758 at the Los Medaños Member .....	2-14
2-19	Piezometers 31X-PE-00211 and 31X-PE-00212 Waste Shaft – Level 845 at the Rustler-Salado Contact .....	2-14
2-20	Earth Pressure Cells Waste Shaft Key – Level 866.....	2-15

## ***List of Figures (Continued)***

---

<b>Figure</b>	<b>Title</b>	<b>Page No.</b>
<b>Exhaust Shaft</b>		
2-21	Piezometer 35X-PE-00202 Exhaust Shaft – Level 544 at the Base of Dewey Lake Redbeds .....	2-17
2-22	Piezometer 35X-PE-00204 Exhaust Shaft – Level 615 at the Magenta Dolomite Member .....	2-17
2-23	Piezometer 35X-PE-00208 Exhaust Shaft – Level 673 at the Tamarisk Member .....	2-18
2-24	Piezometer 35X-PE-00210 Exhaust Shaft – Level 721 at the Culebra Dolomite Member .....	2-18
2-25	Piezometers 35X-PE-00213 and 35X-PE-00214 Exhaust Shaft – Level 768 at the Los Medaños Member .....	2-19
2-26	Piezometers 35X-PE-00216 and 35X-PE-00218 Exhaust Shaft – Level 850 at the Rustler-Salado Contact .....	2-19
2-27	Piezometer 35X-PE-00219 Exhaust Shaft – Level 887 below the Lower Chemical Seal.....	2-20
<b>Shaft Stations</b>		
<b>Salt Handling Shaft Station</b>		
3-1	Convergence Point Array Salt Handling Shaft Station at South 18 – All Chords.....	3-3
3-2	Convergence Point Array Salt Handling Shaft Station at South 30 – All Chords.....	3-3
3-3	Convergence Point Array Salt Handling Shaft Station at South 65 – Roof to Floor.....	3-4
<b>Waste Shaft Station</b>		
3-4	Extensometer 51X-GE-00268 Waste Shaft Station at West 30 – Roof.....	3-6
3-5	Extensometer 51X-GE-00356 Waste Shaft Station Brow – North.....	3-6
3-6	Extensometer 51X-GE-00357 Waste Shaft Station Brow – South.....	3-7
3-7	Convergence Point Array Waste Shaft Station at East 30 – All Chords .....	3-7
3-8	Convergence Point Array Waste Shaft Station at East 90 – All Chords .....	3-8
3-9	Rock Bolt Load Cells Waste Shaft Station Brow – Roof Bolts Set 1 .....	3-8
3-10	Rock Bolt Load Cells Waste Shaft Station Brow – Roof Bolts Set 2 .....	3-9
3-11	Rock Bolt Load Cell Waste Shaft Station at East 40 – Roof.....	3-9
3-12	Rock Bolt Load Cell Waste Shaft Station at East 80 – Roof.....	3-10
<b>Air Intake Shaft Station</b>		
3-13	Extensometer 41X-GE-00122 Air Intake Shaft Station at South 65 – Roof.....	3-13
3-14	Extensometer 41X-GE-00123 Air Intake Shaft Station at North 93 – Roof.....	3-13
3-15	Rock Bolt Load Cells Air Intake Shaft Station Brow – South Side Roof Bolts Set 1 .....	3-14

## ***Last of Figures (Continued)***

<b>Figure</b>	<b>Title</b>	<b>Page No.</b>
3-16	Rock Bolt Load Cells Air Intake Shaft Station Brow – South Side Roof Bolts Set 2 .....	3-14
3-17	Rock Bolt Load Cells Air Intake Shaft Station Brow – North Side Roof Bolts Set 1 .....	3-15
3-18	Rock Bolt Load Cells Air Intake Shaft Station Brow – North Side Roof Bolts Set 2 .....	3-15

### Access Drifts

4-1	Extensometer 51X-GE-00364 E140 Drift at N1266 – Roof .....	4-20
4-2	Extensometer 51X-GE-00365 E140 Drift at N940 – Roof.....	4-20
4-3	Extensometer 41X-GE-00373 E300 Drift at N1341 – Roof.....	4-21
4-4	Extensometer 41X-GE-00388 E300 Drift at N1266 – Roof.....	4-21
4-5	Extensometer 51X-GE-00374 E300 Drift at N1186 – Roof.....	4-22
4-6	Extensometer 51X-GE-00105-3 E140 at N150 – Roof .....	4-22
4-7	Extensometer 51X-GE-00372 E140 Drift at S146 – Roof .....	4-23
4-8	Extensometer 51X-GE-00474 S1000 Drift at E120 – Roof .....	4-23
4-9	Extensometer 51X-GE-00472 E140 Drift at S1000 – Roof .....	4-24
4-10	Extensometer 51X-GE-00473 S1000 Drift at E160 – Roof .....	4-24
4-11	Extensometer 51X-GE-00464 E140 Drift at S1025 – Roof .....	4-25
4-12	Extensometer 51X-GE-00333 E140 Drift at S1075 – Roof .....	4-25
4-13	Extensometer 41X-GE-00103 E140 Drift at S1150 – Roof .....	4-26
4-14	Extensometer 51X-GE-00461 E140 Drift at S1225 – Roof .....	4-26
4-15	Extensometer 51X-GE-00334 E140 Drift at S1225 – Roof .....	4-27
4-16	Extensometer 51X-GE-00462 E120 at S1300 – Roof .....	4-27
4-17	Extensometer 51X-GE-00465 E140 Drift at S1300 – Roof .....	4-28
4-18	Extensometer 51X-GE-00335 E140 Drift at S1300 – Roof .....	4-28
4-19	Extensometer 51X-GE-00463 S1300 Drift at E160– Roof .....	4-29
4-20	Extensometer 51X-GE-00442 S1600 drift at E120 – Roof .....	4-29
4-21	Extensometer 51X-GE-00441 S1600 Drift at E160 – Roof .....	4-30
4-22	Extensometer 51X-GE-00492 E140 Drift at S2750 Drift Intersection – Roof.....	4-30
4-23	Extensometer 51X-GE-00367 E140 Drift at S2916 – Roof .....	4-31
4-24	Extensometer 51X-GE-00361 E0 Drift at N1266 – Roof.....	4-31
4-25	Extensometer 51X-GE-00352 E0 Drift at N940 – Roof.....	4-32
4-26	Extensometer 51X-GE-00353 E0 Drift at N626 – Roof.....	4-32
4-27	Extensometer 51X-GE-00355 E0 Drift at N300 – Roof.....	4-33
4-28	Extensometer 51X-GE-00481 N300 Drift at W10 – Roof .....	4-33
4-29	Extensometer 41X-GE-00127 N300 Drift at W110 – Roof .....	4-34
4-30	Extensometer 41X-GE-00126 N300 Drift at W212 – Roof .....	4-34
4-31	Extensometer 41X-GE-00125 N248 Drift at W417 – Roof .....	4-35
4-32	Extensometer 41X-GE-00124 N190 Drift at W519 – Roof .....	4-35
4-33	Extensometer 51X-GE-00494 E300 Drift at S2892 – Roof .....	4-36

## List of Figures (Continued)

---

Figure	Title	Page No.
4-34	Extensometer 51X-GE-00490 W30 Drift at S2750 Drift Intersection – Roof .....	4-36
4-35	Extensometer 51X-GE-00491 W30 Drift at S2916 – Roof .....	4-37
4-36	Extensometer 51X-GE-00489 W30 Drift at S3080 Drift Intersection – Roof .....	4-37
4-37	Extensometer 51X-GE-00495 W170 Drift at S2634 – Roof .....	4-38
4-38	Convergence Point Array E300 Drift at N1341 – All Chords .....	4-38
4-39	Convergence Point Array E300 Drift at N1262 – All Chords .....	4-39
4-40	Convergence Point Array E300 Drift at N1186 – All Chords .....	4-39
4-41	Convergence Point Array E300 Shop – E300 Drift at N250 – Roof to Floor .....	4-40
4-42	Convergence Point Array E300 Shop – E300 Drift at N170 – All Chords .....	4-40
4-43	Convergence Point Array E300 Shop – E300 Drift at N45 – All Chords .....	4-41
4-44	Convergence Point Array E300 Shop – E300 Drift at S45 – All Chords .....	4-41
4-45	Convergence Point Array E300 Drift at S90 Drift Intersection – Roof to Floor .....	4-42
4-46	Convergence Point Array E300 Drift at S250 – All Chords.....	4-42
4-47	Convergence Point Array E300 Drift at S700 Drift Intersection – Roof to Floor .....	4-43
4-48	Convergence Point Array E300 Drift at S850 – All Chords.....	4-43
4-49	Convergence Point Array E300 Drift at S1000 Drift Intersection – Roof to Floor .....	4-44
4-50	Convergence Point Array E300 Drift at S1150 – Roof to Floor.....	4-44
4-51	Convergence Point Array E300 Drift at S1150 – Rib to Rib.....	4-45
4-52	Convergence Point Array E300 Drift at S1300 Drift Intersection – Roof to Floor .....	4-45
4-53	Convergence Point Array E300 Drift at S1450 – All Chords.....	4-46
4-54	Convergence Point Array E300 Drift at S1687 – All Chords.....	4-46
4-55	Convergence Point Array E300 Drift at S1775 – All Chords.....	4-47
4-56	Convergence Point Array E300 Drift at S1862 – All Chords.....	4-47
4-57	Convergence Point Array E300 Drift at S2065 – All Chords.....	4-48
4-58	Convergence Point Array E300 Drift at S2275 – All Chords.....	4-48
4-59	Convergence Point Array E300 Drift at S2350 – All Chords.....	4-49
4-60	Convergence Point Array E300 Drift at S2425 – All Chords.....	4-49
4-61	Convergence Point Array E300 Drift at S2634 – All Chords.....	4-50
4-62	Convergence Point Array E300 Drift at S2833 – All Chords.....	4-50
4-63	Convergence Point Array E300 Drift at S2916 – All Chords.....	4-51
4-64	Convergence Point Array E300 Drift at S2998 – All Chords.....	4-51
4-65	Convergence Point Array E300 Drift at S3195 – All Chords.....	4-52
4-66	Convergence Point Array E300 Drift at S3480 – All Chords.....	4-52
4-67	Convergence Point Array E140 Drift at N1420 Drift Intersection – Roof to Floor .....	4-53
4-68	Convergence Point Array E140 Drift at N1266 – All Chords .....	4-53
4-69	Convergence Point Array E140 Drift at N1100 Drift Intersection – Roof to Floor .....	4-54
4-70	Convergence Point Array E140 Drift at N940 – All Chords .....	4-54
4-71	Convergence Point Array E140 Drift at N780 Drift Intersection – Roof to Floor .....	4-55
4-72	Convergence Point Array E140 Drift at N686 – All Chords .....	4-55
4-73	Convergence Point Array E140 Drift at N626 – All Chords .....	4-56
4-74	Convergence Point Array E140 Drift at N562 – All Chords .....	4-56
4-75	Convergence Point Array E140 Drift at N460 Drift Intersection – Roof to Floor .....	4-57

## ***List of Figures (Continued)***

---

<b>Figure</b>	<b>Title</b>	<b>Page No.</b>
4-76	Convergence Point Array E140 Drift at N355 – All Chords .....	4-57
4-77	Convergence Point Array E140 Drift at N220 – Roof to Floor .....	4-58
4-78	Convergence Point Array E140 Drift at N150 Drift Intersection – Roof to Floor .....	4-58
4-79	Convergence Point Array E140 Drift at N5 – All Chords .....	4-59
4-80	Convergence Point Array E140 Drift at S90 Drift Intersection – Roof to Floor .....	4-59
4-81	Convergence Point Array E140 Drift at S262 – All Chords.....	4-60
4-82	Convergence Point Array E140 Drift at S460 – All Chords.....	4-60
4-83	Convergence Point Array E140 Drift at S550 – All Chords.....	4-61
4-84	Convergence Point Array E140 Drift at S700 Drift Intersection – Roof to Floor Centerline.....	4-61
4-85	Convergence Point Array E140 Drift at S700 Drift Intersection – Roof to Floor Quarter Points .....	4-62
4-86	Convergence Point Array E140 Drift at S850 – Roof to Floor.....	4-62
4-87	Convergence Point Array E140 Drift at S850 – Rib to Rib.....	4-63
4-88	Convergence Point Array E140 Drift at S1000 Drift Intersection – Roof to Floor .....	4-63
4-89	Convergence Point Array E140 Drift at S1025 – Roof to Floor.....	4-64
4-90	Convergence Point Array E140 Drift at S1075 – All Chords.....	4-64
4-91	Convergence Point Array E140 Drift at S1150 – Roof to Floor.....	4-65
4-92	Convergence Point Array E140 Drift at S1150 – Rib to Rib.....	4-65
4-93	Convergence Point Array E140 Drift at S1225 – All Chords.....	4-66
4-94	Convergence Point Array E140 Drift at S1300 Drift Intersection – Roof to Floor .....	4-66
4-95	Convergence Point Array E140 Drift at S1378 – Roof to Floor.....	4-67
4-96	Convergence Point Array E140 Drift at S1378 – Rib to Rib.....	4-67
4-97	Convergence Point Array E140 Drift at S1450/S1456 – Roof to Floor – Centerline .....	4-68
4-98	Convergence Point Array E140 Drift at S1450/S1456 – Roof to Floor – Quarter Points .....	4-68
4-99	Convergence Point Array E140 Drift at S1450/S1456 – Rib to Rib – Midheight.....	4-69
4-100	Convergence Point Array E140 Drift at S1450/S1456 – Rib to Rib – Quarter Points .....	4-69
4-101	Convergence Point Array E140 Drift at S1534 – All Chords.....	4-70
4-102	Convergence Point Array E140 Drift at S1600 Drift Intersection – Roof to Floor .....	4-70
4-103	Convergence Point Array E140 Drift at S1687 – All Chords.....	4-71
4-104	Convergence Point Array E140 Drift at S1775 – Roof to Floor.....	4-71
4-105	Convergence Point Array E140 Drift at S1775 – Rib to Rib.....	4-72
4-106	Convergence Point Array E140 Drift at S1862 – All Chords.....	4-72
4-107	Convergence Point Array E140 Drift at S1950 Drift Intersection – Roof to Floor .....	4-73
4-108	Convergence Point Array E140 Drift at S2007 – Roof to Floor.....	4-73
4-109	Convergence Point Array E140 Drift at S2065 – All Chords.....	4-74
4-110	Convergence Point Array E140 Drift at S2122 – Roof to Floor.....	4-74
4-111	Convergence Point Array E140 Drift at S2180 Drift Intersection – Roof to Floor .....	4-75
4-112	Convergence Point Array E140 Drift at S2275 – All Chords.....	4-75



## ***List of Figures (Continued)***

---

<b>Figure</b>	<b>Title</b>	<b>Page No.</b>
4-113	Convergence Point Array E140 Drift at S2350 – All Chords.....	4-76
4-114	Convergence Point Array E140 Drift at S2425 – All Chords.....	4-76
4-115	Convergence Point Array E140 Drift at S2520 Drift Intersection – Roof to Floor.....	4-77
4-116	Convergence Point Array E140 Drift at S2634 – All Chords.....	4-77
4-117	Convergence Point Array E140 Drift at S2750 Drift Intersection – Roof to Floor.....	4-78
4-118	Convergence Point Array E140 Drift at S2833 – All Chords.....	4-78
4-119	Convergence Point Array E140 Drift at S2915 – All Chords.....	4-79
4-120	Convergence Point Array E140 Drift at S2998 – All Chords.....	4-79
4-121	Convergence Point Array E140 Drift at S3080 Drift Intersection – Roof to Floor.....	4-80
4-122	Convergence Point Array E140 Drift at S3195 – All Chords.....	4-80
4-123	Convergence Point Array E140 Drift at S3295 – Roof to Floor.....	4-81
4-124	Convergence Point Array E140 Drift at S3325 – Roof to Floor.....	4-81
4-125	Convergence Point Array E140 Drift at S3395 – All Chords.....	4-82
4-126	Convergence Point Array E140 Drift at S3480 – All Chords.....	4-82
4-127	Convergence Point Array E140 Drift at S3565 – All Chords.....	4-83
4-128	Convergence Point Array E140 Drift at S3650 Drift Intersection – All Chords.....	4-83
4-129	Convergence Point Array E0 Drift at N1420 Drift Intersection – All Chords.....	4-84
4-130	Convergence Point Array E0 Drift at N1266 – All Chords.....	4-84
4-131	Convergence Point Array E0 Drift at N1100 Drift Intersection – All Chords.....	4-85
4-132	Convergence Point Array E0 Drift at N940 – All Chords.....	4-85
4-133	Convergence Point Array E0 Drift at N780 – Roof to Floor.....	4-86
4-134	Convergence Point Array E0 Drift at N686 – All Chords.....	4-86
4-135	Convergence Point Array E0 Drift at N626 – All Chords.....	4-87
4-136	Convergence Point Array E0 Drift at N562 – All Chords.....	4-87
4-137	Convergence Point Array E0 Drift at N460 Drift Intersection – Roof to Floor.....	4-88
4-138	Convergence Point Array E0 Drift at N300 – All Chords.....	4-88
4-139	Convergence Point Array E0 Drift at N225 – All Chords.....	4-89
4-140	Convergence Point Array E0 Drift at N75 – All Chords.....	4-89
4-141	Convergence Point Array W30 Drift at S120 – Roof to Floor.....	4-90
4-142	Convergence Point Array W30 Drift at S250 – All Chords.....	4-90
4-143	Convergence Point Array W30 Drift at S400 Drift Intersection – Roof to Floor.....	4-91
4-144	Convergence Point Array W30 Drift at S500 – All Chords.....	4-91
4-145	Convergence Point Array W30 Drift at S700 Drift Intersection – Roof to Floor.....	4-92
4-146	Convergence Point Array W30 Drift at S850 – All Chords.....	4-92
4-147	Convergence Point Array W30 Drift at S1000 Drift Intersection – Roof to Floor.....	4-93
4-148	Convergence Point Array W30 Drift at S1100 – Roof to Floor.....	4-93
4-149	Convergence Point Array W30 Drift at S1200 – Roof to Floor.....	4-94
4-150	Convergence Point Array W30 Drift at S1300 Drift Intersection – Roof to Floor.....	4-94
4-151	Convergence Point Array W30 Drift at S1453 – All Chords.....	4-95
4-152	Convergence Point Array W30 Drift at S1600 Drift Intersection – Roof to Floor.....	4-95
4-153	Convergence Point Array W30 Drift at S1775 – All Chords.....	4-96

## ***List of Figures (Continued)***

---

<b>Figure</b>	<b>Title</b>	<b>Page No.</b>
4-154	Convergence Point Array W30 Drift at S1950 Drift Intersection – Roof to Floor.....	4-96
4-155	Convergence Point Array W30 Drift at S2067 – All Chords .....	4-97
4-156	Convergence Point Array W30 Drift at S2180 Drift Intersection – Roof to Floor.....	4-97
4-157	Convergence Point Array W30 Drift at S2275 – All Chords .....	4-98
4-158	Convergence Point Array W30 Drift at S2350 – All Chords .....	4-98
4-159	Convergence Point Array W30 Drift at S2425 – All Chords .....	4-99
4-160	Convergence Point Array W30 Drift at S2520 Drift Intersection – Roof to Floor.....	4-99
4-161	Convergence Point Array W30 Drift at S2685 – All Chords .....	4-100
4-162	Convergence Point Array W30 Drift at S2750 Drift Intersection – Roof to Floor.....	4-100
4-163	Convergence Point Array W30 Drift at S2833 – All Chords .....	4-101
4-164	Convergence Point Array W30 Drift at S2916 – All Chords .....	4-101
4-165	Convergence Point Array W30 Drift at S2998 – All Chords .....	4-102
4-166	Convergence Point Array W30 Drift at S3080 Drift Intersection – Roof to Floor.....	4-102
4-167	Convergence Point Array W30 Drift at S3195 – All Chords .....	4-103
4-168	Convergence Point Array W30 Drift at S3310 Drift Intersection – Roof to Floor.....	4-103
4-169	Convergence Point Array W30 Drift at S3395 – All Chords .....	4-104
4-170	Convergence Point Array W30 Drift at S3480 – All Chords .....	4-104
4-171	Convergence Point Array W30 Drift at S3565 – All Chords .....	4-105
4-172	Convergence Point Array W30 Drift at S3560 Drift Intersection – Roof to Floor.....	4-105
4-173	Convergence Point Array W170 Drift at N150 Drift Intersection – Roof to Floor....	4-106
4-174	Convergence Point Array W170 Drift at S5 – All Chords .....	4-106
4-175	Convergence Point Array W170 Drift at S90 – Roof to Floor .....	4-107
4-176	Convergence Point Array W170 Drift at S232 – All Chords .....	4-107
4-177	Convergence Point Array W170 Drift at S400 Drift Intersection – Roof to Floor.....	4-108
4-178	Convergence Point Array W170 Drift at S560 – All Chords .....	4-108
4-179	Convergence Point Array W170 Drift at S700 Drift Intersection – Roof to Floor.....	4-109
4-180	Convergence Point Array W170 Drift at S850 – Roof to Floor – Centerline.....	4-109
4-181	Convergence Point Array W170 Drift at S850 – Roof to Floor – Quarter Points .....	4-110
4-182	Convergence Point Array W170 Drift at S850 – Rib to Rib .....	4-110
4-183	Convergence Point Array W170 Drift at S1000 Drift Intersection – Roof to Floor... 4-111	4-111
4-184	Convergence Point Array W170 Drift at S1150 – All Chords .....	4-111
4-185	Convergence Point Array W170 Drift at S1300 Drift Intersection – Roof to Floor... 4-112	4-112
4-186	Convergence Point Array W170 Drift at S1445 – All Chords .....	4-112
4-187	Convergence Point Array W170 Drift at S1600 Drift Intersection – Roof to Floor... 4-113	4-113
4-188	Convergence Point Array W170 Drift at S1779 – All Chords .....	4-113
4-189	Convergence Point Array W170 Drift at S1950 Drift Intersection – Roof to Floor... 4-114	4-114
4-190	Convergence Point Array W170 Drift at S2060 – All Chords .....	4-114
4-191	Convergence Point Array W170 Drift at S2180 Drift Intersection – Roof to Floor... 4-115	4-115
4-192	Convergence Point Array W170 Drift at S2275 – All Chords .....	4-115
4-193	Convergence Point Array W170 Drift at S2350 – All Chords .....	4-116
4-194	Convergence Point Array W170 Drift at S2425 – All Chords .....	4-116
4-195	Convergence Point Array W170 Drift at S2520 Drift Intersection – Roof to Floor... 4-117	4-117

## ***List of Figures (Continued)***

---

<b>Figure</b>	<b>Title</b>	<b>Page No.</b>
4-196	Convergence Point Array W170 Drift at S2685 – All Chords .....	4-117
4-197	Convergence Point Array W170 Drift at S2750 Drift Intersection – Roof to Floor...	4-118
4-198	Convergence Point Array W170 Drift at S2833 – All Chords .....	4-118
4-199	Convergence Point Array W170 Drift at S2916 – All Chords .....	4-119
4-200	Convergence Point Array W170 Drift at S2998 – All Chords .....	4-119
4-201	Convergence Point Array W170 Drift at S3080 Drift Intersection – Roof to Floor...	4-120
4-202	Convergence Point Array W170 Drift at S3195 – All Chords .....	4-120
4-203	Convergence Point Array W170 Drift at S3310 Drift Intersection – Roof to Floor...	4-121
4-204	Convergence Point Array W170 Drift at S3395 – All Chords .....	4-121
4-205	Convergence Point Array W170 Drift at S3480 – All Chords .....	4-122
4-206	Convergence Point Array W170 Drift at S3565 – All Chords .....	4-122
4-207	Convergence Point Array W170 Drift at S3650 Drift Intersection – Roof to Floor...	4-123
4-208	Convergence Point Array N780 Drift at E70 – All Chords .....	4-123
4-209	Convergence Point Array N460 Drift at E70 – All Chords .....	4-124
4-210	Convergence Point Array N300 Drift at W170 – All Chords.....	4-124
4-211	Convergence Point Array W250 Drift at E220 – All Chords .....	4-125
4-212	Convergence Point Array N215 Drift at W500 – All Chords.....	4-125
4-213	Convergence Point Array N215 Drift at W620 at Air Intake Shaft – Roof to Floor..	4-126
4-214	Convergence Point Array N140 Drift at E90 – All Chords .....	4-126
4-215	Convergence Point Array N140 Drift at W50 – Rib.....	4-127
4-216	Convergence Point Array S90 Drift at W120 – All Chords .....	4-127
4-217	Convergence Point Array S90 Drift at W400 – All Chords .....	4-128
4-218	Convergence Point Array S90 Drift at W590 – All Chords .....	4-128
4-219	Convergence Point Array S90 Drift at W620 – Roof to Floor .....	4-129
4-220	Convergence Point Array S90 Drift at W770 – All Chords .....	4-129
4-221	Convergence Point Array S90 Drift at W905 – Roof to Floor .....	4-130
4-222	Convergence Point Array S400 Core Storage Library – All Chords.....	4-130
4-223	Convergence Point Array S700 Drift at E55 – All Chords.....	4-131
4-224	Convergence Point Array S700 Drift at W98 – Roof to Floor .....	4-131
4-225	Convergence Point Array S1000 Drift at E160 – Roof to Floor.....	4-132
4-226	Convergence Point Array S1000 Drift at E120 – Roof to Floor.....	4-132
4-227	Convergence Point Array S1000 Drift at E58 – All Chords.....	4-133
4-228	Convergence Point Array S1000 Drift at W98 – All Chords .....	4-133
4-229	Convergence Point Array S1300 Drift at E160 – Roof to Floor.....	4-134
4-230	Convergence Point Array S1300 Drift at E120 – Roof to Floor.....	4-134
4-231	Convergence Point Array S1300 Drift at E24 – Roof to Floor.....	4-135
4-232	Convergence Point Array S1300 Drift at W100 – Roof to Floor .....	4-135
4-233	Convergence Point Array S1600 Drift at E170 – Roof to Floor.....	4-136
4-234	Convergence Point Array S1600 Drift at E110 – Roof to Floor.....	4-136
4-235	Convergence Point Array S1950 Drift at E113 – Roof to Floor.....	4-137
4-236	Convergence Point Array S1950 Drift at E281 – Roof to Floor.....	4-137
4-237	Convergence Point Array S1950 Drift at E284 – Roof to Floor.....	4-138

## ***List of Figures (Continued)***

---

<b>Figure</b>	<b>Title</b>	<b>Page No.</b>
4-238	Convergence Point Array S2180 Drift at E55 – All Chords.....	4-138
4-239	Convergence Point Array S2180 Drift at E220 – All Chords.....	4-139
4-240	Convergence Point Array S2180 Drift at W100 – All Chords .....	4-139
4-241	Convergence Point Array S2520 Drift at E220 – All Chords.....	4-140
4-242	Convergence Point Array S2520 Drift at W100 – All Chords .....	4-140
4-243	Convergence Point Array S2750 Drift at E55 – All Chords.....	4-141
4-244	Convergence Point Array S2750 Drift at E220 – All Chords.....	4-141
4-245	Convergence Point Array S2750 Drift at W93 – All Chords .....	4-142
4-246	Convergence Point Array S3080 Drift at E55 – All Chords.....	4-142
4-247	Convergence Point Array S3080 Drift at E220 – All Chords.....	4-143
4-248	Convergence Point Array S3080 Drift at W100 – All Chords .....	4-143
4-249	Convergence Point Array S3310 Drift at E55 – All Chords.....	4-144
4-250	Convergence Point Array S3310 Drift at E220 – All Chords.....	4-144
4-251	Convergence Point Array S3310 Drift at W100 – All Chords .....	4-145
4-252	Convergence Point Array S3650 Drift at E55 – Roof to Floor.....	4-145
4-253	Convergence Point Array S3650 Drift at E220 – Roof to Floor.....	4-146
4-254	Convergence Point Array S3650 Drift at W100 – All Chords .....	4-146
4-255	Joint Meters S1950 Drift at E300 Drift Overcast .....	4-147
4-256	Rock Bolt Load Cells E140 Drift at S1300 Brows .....	4-147
4-257	Rock Bolt Load Cells E140 Drift at S1550 .....	4-148
4-258	Rock Bolt Load Cells E140 Drift at S1600 Brows .....	4-148
4-259	Rock Bolt Load Cells E140 Drift at S1775 .....	4-149
4-260	Rock Bolt Load Cells E140 Drift at S2900 .....	4-149

### Waste Disposal Area Panel 1 Access Drifts

5-1	Convergence Point Array S1600 Drift at E311 – All Chords.....	5-3
5-2	Convergence Point Array S1600 Drift at E332 – All Chords.....	5-3
5-3	Convergence Point Array S1600 Drift at E357 – All Chords.....	5-4
5-4	Convergence Point Array S1600 Drift at E382 – All Chords.....	5-4
5-5	Convergence Point Array S1600 Drift at E407 – Roof to Floor.....	5-5
5-6	Convergence Point Array S1600 Drift at E432 – All Chords.....	5-5
5-7	Convergence Point Array S1600 Drift at E453 – All Chords.....	5-6
5-8	Convergence Point Array S1950 Drift at E311 – All Chords.....	5-6
5-9	Convergence Point Array S1950 Drift at E332 – All Chords.....	5-7
5-10	Convergence Point Array S1950 Drift at E357 – All Chords.....	5-7
5-11	Convergence Point Array S1950 Drift at E382 – All Chords.....	5-8
5-12	Convergence Point Array S1950 Drift at E407 – Roof to Floor.....	5-8
5-13	Convergence Point Array S1950 Drift at E407 – Rib to Rib.....	5-9
5-14	Convergence Point Array S1950 Drift at E432 – All Chords.....	5-9
5-15	Convergence Point Array S1950 Drift at E457 – All Chords.....	5-10

## List of Figures (Continued)

---

Figure	Title	Page No.
Waste Disposal Area Panel 2		
5-16	Convergence Point Array S2180 Drift at E410 – All Chords.....	5-12
5-17	Convergence Point Array S2520 Drift at E410 – All Chords.....	5-12
Waste Disposal Area Panel 3		
5-18	Extensometer 51X-GE-00354-2 Room 1, Panel 3 – Room Center – Roof .....	5-15
5-19	Extensometer 51X-GE-00358 Room 2, Panel 3 – Room Center – Roof.....	5-15
5-20	Extensometer 51X-GE-00359 Room 3, Panel 3 – Room Center – Roof.....	5-16
5-21	Extensometer 51X-GE-00362 Room 5, Panel 3 – Room Center – Roof .....	5-16
5-22	Extensometer 51X-GE-00363 Room 6, Panel 3 – Room Center – Roof.....	5-17
5-23	Extensometer 51X-GE-00366 Room 7, Panel 3 – Room Center – Roof.....	5-17
5-24	Extensometer 51X-GE-00370 S2750 Drift at E725 – Roof .....	5-18
5-25	Extensometer 51X-GE-00371 S2750 Drift at E1115 – Roof .....	5-18
5-26	Extensometer 51X-GE-00369 S3080 Drift at E725 – Roof .....	5-19
5-27	Extensometer 51X-GE-00368 S3080 Drift at E1120 – Roof .....	5-19
5-28	Rock Bolt Load Cell S3080 Drift at E580 – Roof.....	5-20
5-29	Rock Bolt Load Cell S3080 Drift at E727 – Roof.....	5-20
5-30	Convergence Point Array S2750 Drift at E410 – All Chords.....	5-21
5-3	Convergence Point Array S2750 Drift at E520 Drift Intersection (Room 1, Panel 3) – Roof to Floor .....	5-21
5-32	Convergence Point Array S2750 Drift at E586 – Roof to Floor.....	5-22
5-33	Convergence Point Array S2750 Drift at E660 Drift Intersection (Room 2, Panel 3) – Roof to Floor .....	5-22
5-34	Convergence Point Array S3080 Drift at E410 – All Chords.....	5-23
5-35	Convergence Point Array S3080 Drift at E520 Drift Intersection (Room 1, Panel 3) – Roof to Floor .....	5-23
5-36	Convergence Point Array S3080 Drift at E586 – All Chords.....	5-24
5-37	Convergence Point Array S3080 Drift at E660 Drift Intersection (Room 2, Panel 3) – Roof to Floor .....	5-24
5-38	Convergence Point Array S3080 Drift at E725 – All Chords.....	5-25
5-39	Convergence Point Array S3080 Drift at E790 Drift Intersection (Room 3, Panel 3) – Roof to Floor .....	5-25
5-40	Convergence Point Array Room 1, Panel 3 at S2833 – All Chords .....	5-26
5-41	Convergence Point Array Room 1, Panel 3 at S2916 – Room Center – All Chords.....	5-26
5-42	Convergence Point Array Room 1, Panel 3 at S2998 – All Chords .....	5-27
5-43	Convergence Point Array Room 2, Panel 3 at S2833 – Roof to Floor .....	5-27
5-44	Convergence Point Array Room 2, Panel 3 at S2916 – Room Center – All Chords.....	5-28
5-45	Convergence Point Array Room 2, Panel 3 at S2998 – All Chords .....	5-28

## ***List of Figures (Continued)***

---

<b>Figure</b>	<b>Title</b>	<b>Page No.</b>
Waste Disposal Area Panel 4		
5-46	Extensometer 51X-GE-00376, Room 1, Panel 4 – Room Center – Roof .....	5-33
5-47	Extensometer 51X-GE-00378, Room 2 Panel 4 – Room Center – Roof .....	5-33
5-48	Extensometer 51X-GE-00383, Room 3, Panel 4 – Room Center – Roof .....	5-34
5-49	Extensometer 51X-GE-00380, Room 4, Panel 4 – Room Center – Roof .....	5-34
5-50	Extensometer 51X-GE-00387, Room 5, Panel 4 – Room Center – Roof .....	5-35
5-51	Extensometer 51X-GE-00381, Room 6, Panel 4 – Room Center – Roof .....	5-35
5-52	Extensometer 51X-GE-00382, Room 7, Panel 4 – Room Center – Roof .....	5-36
5-53	Extensometer 51X-GE-00377, S3310 Drift at E725 – Roof .....	5-36
5-54	Extensometer 51X-GE-00384, S3310 Drift at E1125 – Roof .....	5-37
5-55	Extensometer 51X-GE-00386, S3650 Drift at E725 – Roof .....	5-37
5-56	Extensometer 51X-GE-00385, S3650 Drift at E1125 – Roof .....	5-38
5-57	Rock Bolt Load Cell, Room 1, Panel 4 .....	5-38
5-58	Rock Bolt Load Cell, Room 2, Panel 4 .....	5-39
5-59	Rock Bolt Load Cell, Room 2, Panel 4 .....	5-39
5-60	Rock Bolt Load Cell, Room 3, Panel 4 .....	5-40
5-61	Rock Bolt Load Cell, Room 4, Panel 4 .....	5-40
5-62	Rock Bolt Load Cell, Room 5, Panel 4 .....	5-41
5-63	Rock Bolt Load Cell, Room 6, Panel 4 .....	5-41
5-64	Rock Bolt Load Cell, Room 7, Panel 4 .....	5-42
5-65	Rock Bolt Load Cell, S3310 Drift at E727 .....	5-42
5-66	Rock Bolt Load Cell, S3650 Drift at E727 .....	5-43
5-67	Rock Bolt Load Cell, S3650 Drift at E1125 .....	5-43
5-68	Convergence Point Array S3310 Drift at E410 – Roof to Floor.....	5-44
5-69	Convergence Point Array S3310 Drift at E520 Drift Intersection (Room 1, Panel 4) – Roof to Floor .....	5-44
5-70	Convergence Point Array S3310 Drift at E586 – Roof to Floor.....	5-45
5-71	Convergence Point Array S3310 Drift at E660 Drift Intersection (Room 2, Panel 4) – Roof to Floor .....	5-45
5-72	Convergence Point Array S3310 Drift at E727 – Roof to Floor.....	5-46
5-73	Convergence Point Array S3310 Drift at E790 Drift Intersection (Room 3, Panel 4) – Roof to Floor .....	5-46
5-74	Convergence Point Array S3310 Drift at E855 – Roof to Floor.....	5-47
5-75	Convergence Point Array S3310 Drift at E920 Drift Intersection (Room 4, Panel 4) – Roof to Floor .....	5-47
5-76	Convergence Point Array S3310 Drift at E986 – Roof to Floor.....	5-48
5-77	Convergence Point Array S3310 Drift at E1050 Drift Intersection (Room 5, Panel 4) – Roof to Floor .....	5-48
5-78	Convergence Point Array S3310 Drift at E1120 – Roof to Floor.....	5-49
5-79	Convergence Point Array S3310 Drift at E1190 Drift Intersection (Room 6, Panel 4) – Roof to Floor .....	5-49

## ***List of Figures (Continued)***

---

<b>Figure</b>	<b>Title</b>	<b>Page No.</b>
5-80	Convergence Point Array S3310 Drift at E1255 – Roof to Floor .....	5-50
5-81	Convergence Point Array S3310 Drift at E1320 Drift Intersection (Room 7, Panel 4) – Roof to Floor .....	5-50
5-82	Convergence Point Array Room 1, Panel 4 at S3395 – All Chords .....	5-51
5-83	Convergence Point Array Room 1, Panel 4 at S3480 – Room Center – All Chords .....	5-51
5-84	Convergence Point Array Room 1, Panel 4 at S3565 – All Chords .....	5-52
5-85	Convergence Point Array Room 2, Panel 4 at S3395 – All Chords .....	5-52
5-86	Convergence Point Array Room 2, Panel 4 at S3480 – Room Center – All Chords .....	5-53
5-87	Convergence Point Array Room 2, Panel 4 at S3565 – All Chords .....	5-53
5-88	Convergence Point Array Room 3, Panel 4 at S3395 – All Chords .....	5-54
5-89	Convergence Point Array Room 3, Panel 4 at S3480 – Room Center – All Chords .....	5-54
5-90	Convergence Point Array Room 3, Panel 4 at S3565 – All Chords .....	5-55
5-91	Convergence Point Array Room 4, Panel 4 at S3395 – All Chords .....	5-55
5-92	Convergence Point Array Room 4, Panel 4 at S3480 – Room Center – All Chords .....	5-56
5-93	Convergence Point Array Room 4, Panel 4 at S3565 – All Chords .....	5-56
5-94	Convergence Point Array Room 5, Panel 4 at S3395 – All Chords .....	5-57
5-95	Convergence Point Array Room 5, Panel 4 at S3480 – Room Center – All Chords .....	5-57
5-96	Convergence Point Array Room 5, Panel 4 at S3565 – All Chords .....	5-58
5-97	Convergence Point Array Room 6, Panel 4 at S3395 – All Chords .....	5-58
5-98	Convergence Point Array Room 6, Panel 4 at S3480 – Room Center – All Chords .....	5-59
5-99	Convergence Point Array Room 6, Panel 4 at S3565 – All Chords .....	5-59
5-100	Convergence Point Array Room 7, Panel 4 at S3395 – All Chords .....	5-60
5-101	Convergence Point Array Room 7, Panel 4 at S3480 – Room Center – All Chords .....	5-60
5-102	Convergence Point Array Room 7, Panel 4 at S3565 – All Chords .....	5-61
5-103	Convergence Point Array S3650 Drift at E520 Drift Intersection (Room 1, Panel 4) – Roof to Floor .....	5-61
5-104	Convergence Point Array S3650 Drift at E586 – Roof to Floor .....	5-62
5-105	Convergence Point Array S3650 Drift at E660 Drift Intersection (Room 2, Panel 4) – Roof to Floor .....	5-62
5-106	Convergence Point Array S3650 Drift at E725 – Roof to Floor .....	5-63
5-107	Convergence Point Array S3650 Drift at E790 Drift Intersection (Room 3, Panel 4) – Roof to Floor .....	5-63
5-108	Convergence Point Array S3650 Drift at E855 – Roof to Floor .....	5-64
5-109	Convergence Point Array S3650 Drift at E920 Drift Intersection (Room 4, Panel 4) – Roof to Floor .....	5-64
5-110	Convergence Point Array S3650 Drift at E986 – Roof to Floor .....	5-65
5-111	Convergence Point Array S3650 Drift at E1050 Drift Intersection (Room 5, Panel 4) – Roof to Floor .....	5-65
5-112	Convergence Point Array S3650 Drift at E1120 – Roof to Floor .....	5-66
5-113	Convergence Point Array S3650 Drift at E1190 Drift Intersection (Room 6, Panel 4) – Roof to Floor .....	5-66
5-114	Convergence Point Array S3650 Drift at E1255 – Roof to Floor .....	5-67

## ***List of Figures (Continued)***

---

<b>Figure</b>	<b>Title</b>	<b>Page No.</b>
5-115	Convergence Point Array S3650 Drift at E1320 Drift Intersection (Room 7, Panel 4) – Roof to Floor .....	5-67
 Waste Disposal Area Panel 5		
5-116	Extensometer 51X-GE-00389, Room 1, Panel 5 – Room Center – Roof .....	5-71
5-117	Extensometer 51X-GE-00390, Room 2, Panel 5 – Room Center – Roof .....	5-71
5-118	Convergence Point Array S3310 Drift at W285 – Roof to Floor .....	5-72
5-119	Convergence Point Array S3310 Drift at W390 Drift Intersection (Room 1, Panel 5) – Roof to Floor .....	5-72
5-120	Convergence Point Array S3310 Drift at W520 Drift Intersection (Room 2, Panel 5) – Roof to Floor .....	5-73
5-121	Convergence Point Array S3310 Drift at W590 – Roof to Floor .....	5-73
5-122	Convergence Point Array S3310 Drift at W660 Drift Intersection (Room 3, Panel 5) – Roof to Floor .....	5-74
5-123	Convergence Point Array S3310 Drift at W725 – Roof to Floor .....	5-74
5-124	Convergence Point Array S3310 Drift at W790 Drift Intersection (Room 4, Panel 5) – Roof to Floor .....	5-75
5-125	Convergence Point Array S3310 Drift at W855 – Roof to Floor .....	5-75
5-126	Convergence Point Array S3310 Drift at W920 Drift Intersection (Room 5, Panel 5) – Roof to Floor .....	5-76
5-127	Convergence Point Array S3310 Drift at W985 – Roof to Floor .....	5-76
5-128	Convergence Point Array S3310 Drift at W1050 Drift Intersection (Room 6, Panel 5) – Roof to Floor .....	5-77
5-129	Convergence Point Array S3310 Drift at W1120 – Roof to Floor .....	5-77
5-130	Convergence Point Array S3310 Drift at W1190 Drift Intersection (Room 7, Panel 5) – Roof to Floor .....	5-78
5-131	Convergence Point Array S3650 Drift at W390 Drift Intersection (Room 1, Panel 5) – Roof to Floor .....	5-78
5-132	Convergence Point Array S3650 Drift at W456 – Roof to Floor .....	5-79
5-133	Convergence Point Array S3650 Drift at W520 Drift Intersection (Room 2, Panel 5) – Roof to Floor .....	5-79
5-134	Convergence Point Array S3650 Drift at W585 – Roof to Floor .....	5-80
5-135	Convergence Point Array S3650 Drift at W660 Drift Intersection (Room 3, Panel 5) – Roof to Floor .....	5-80
5-136	Convergence Point Array S3650 Drift at W725 – Roof to Floor .....	5-81
5-137	Convergence Point Array S3650 Drift at W790 Drift Intersection (Room 4, Panel 5) – Roof to Floor .....	5-81
5-138	Convergence Point Array S3650 Drift at W855 – Roof to Floor .....	5-82
5-139	Convergence Point Array Room 1, Panel 5 at S3395 – Roof to Floor .....	5-82



## ***List of Figures (Continued)***

---

<b>Figure</b>	<b>Title</b>	<b>Page No.</b>
5-140	Convergence Point Array Room 1, Panel 5 at S3480 – Room Center – Roof to Floor .....	5-83
5-141	Convergence Point Array Room 1, Panel 5 at S3565 – Roof to Floor .....	5-83
5-142	Convergence Point Array Room 2, Panel 5 at S3395 – Roof to Floor .....	5-84
5-143	Convergence Point Array Room 2, Panel 5 at S3480 – Room Center – Roof to Floor .....	5-84
5-144	Convergence Point Array Room 2, Panel 5 at S3565 – Roof to Floor .....	5-85
5-145	Convergence Point Array Room 3, Panel 5 at S3395 – Roof to Floor .....	5-85
5-146	Convergence Point Array Room 3, Panel 5 at S3480 – Room Center – Roof to Floor .....	5-86
5-147	Convergence Point Array Room 3, Panel 5 at S3565 – Roof to Floor .....	5-86
5-148	Convergence Point Array Room 4, Panel 5 at S3395 – Roof to Floor .....	5-87
5-149	Convergence Point Array Room 4, Panel 5 at S3480 – Room Center – Roof to Floor .....	5-87
5-150	Convergence Point Array Room 4, Panel 5 at S3565 – Roof to Floor .....	5-88

### Geosciences Program

6-1	Panel 4, Room 1, S3340-S3630 Roof Fractures (Sheet 1 of 3) .....	6-27
6-2	Panel 4, Room 1, S3340-S3630 Roof Fractures (Sheet 2 of 3) .....	6-28
6-3	Panel 4, Room 1, S3340-S3630 Roof Fractures (Sheet 3 of 3) .....	6-29
6-4	Panel 4, Room 2, S3340-S3360 Roof Fractures (Sheet 1 of 3) .....	6-30
6-5	Panel 4, Room 2, S3340-S3360 Roof Fractures (Sheet 2 of 3) .....	6-31
6-6	Panel 4, Room 2, S3340-S3360 Roof Fractures (Sheet 3 of 3) .....	6-32
6-7	Panel 4, Room 3, S3340-S3360 Roof Fractures (Sheet 1 of 3) .....	6-33
6-8	Panel 4, Room 3, S3340-S3360 Roof Fractures (Sheet 2 of 3) .....	6-34
6-9	Panel 4, Room 3, S3340-S3360 Roof Fractures (Sheet 3 of 3) .....	6-35
6-10	Panel 4, Room 4, S3340-S3360 Roof Fractures (Sheet 1 of 3) .....	6-36
6-11	Panel 4, Room 4, S3340-S3360 Roof Fractures (Sheet 2 of 3) .....	6-37
6-12	Panel 4, Room 4, S3340-S3360 Roof Fractures (Sheet 3 of 3) .....	6-38
6-13	Panel 4, Room 5, S3340-S3360 Roof Fractures (Sheet 1 of 3) .....	6-39
6-14	Panel 4, Room 5, S3340-S3360 Roof Fractures (Sheet 2 of 3) .....	6-40
6-15	Panel 4, Room 5, S3340-S3360 Roof Fractures (Sheet 3 of 3) .....	6-41
6-16	Panel 4, Room 6, S3340-S3360 Roof Fractures (Sheet 1 of 3) .....	6-42
6-17	Panel 4, Room 6, S3340-S3360 Roof Fractures (Sheet 2 of 3) .....	6-43
6-18	Panel 4, Room 6, S3340-S3360 Roof Fractures (Sheet 3 of 3) .....	6-44
6-19	Panel 4, Room 7, S3340-S3360 Roof Fractures (Sheet 1 of 3) .....	6-45
6-20	Panel 4, Room 7, S3340-S3360 Roof Fractures (Sheet 2 of 3) .....	6-46
6-21	Panel 4, Room 7, S3340-S3360 Roof Fractures (Sheet 3 of 3) .....	6-47
6-22	Panel 4, S3310, E500-E1335 Roof Fractures (Sheet 1 of 9) .....	6-48
6-23	Panel 4, S3310, E500-E1335 Roof Fractures (Sheet 2 of 9) .....	6-49
6-24	Panel 4, S3310, E500-E1335 Roof Fractures (Sheet 3 of 9) .....	6-50

## ***List of Figures (Continued)***

---

<b>Figure</b>	<b>Title</b>	<b>Page No.</b>
6-25	Panel 4, S3310, E500-E1335 Roof Fractures (Sheet 4 of 9) .....	6-51
6-26	Panel 4, S3310, E500-E1335 Roof Fractures (Sheet 5 of 9) .....	6-52
6-27	Panel 4, S3310, E500-E1335 Roof Fractures (Sheet 6 of 9) .....	6-53
6-28	Panel 4, S3310, E500-E1335 Roof Fractures (Sheet 7 of 9) .....	6-54
6-29	Panel 4, S3310, E500-E1335 Roof Fractures (Sheet 8 of 9) .....	6-55
6-30	Panel 4, S3310, E500-E1335 Roof Fractures (Sheet 9 of 9) .....	6-56
6-31	Panel 4, S3650, E500-E1335 Roof Fractures (Sheet 1 of 9) .....	6-57
6-32	Panel 4, S3650, E500-E1335 Roof Fractures (Sheet 2 of 9) .....	6-58
6-33	Panel 4, S3650, E500-E1335 Roof Fractures (Sheet 3 of 9) .....	6-59
6-34	Panel 4, S3650, E500-E1335 Roof Fractures (Sheet 4 of 9) .....	6-60
6-35	Panel 4, S3650, E500-E1335 Roof Fractures (Sheet 5 of 9) .....	6-61
6-36	Panel 4, S3650, E500-E1335 Roof Fractures (Sheet 6 of 9) .....	6-62
6-37	Panel 4, S3650, E500-E1335 Roof Fractures (Sheet 7 of 9) .....	6-63
6-38	Panel 4, S3650, E500-E1335 Roof Fractures (Sheet 8 of 9) .....	6-64
6-39	Panel 4, S3650, E500-E1335 Roof Fractures (Sheet 9 of 9) .....	6-65

This page is intentionally blank.

## **1.0 Introduction**

This report is a compilation of geotechnical data presented as plots for each active instrument installed in the underground at the Waste Isolation Pilot Plant (WIPP) through June 30, 2007. A summary of the geotechnical analyses that were performed using the enclosed data is provided in Volume 1 of the Geotechnical Analysis Report (GAR).

### **1.1 Instrumentation**

Geomechanical instrument data included in this report reflect the measurements of the geomechanical response of the underground and shafts. The instruments consist of convergence points, borehole extensometers, rockbolt load cells, pressure cells, strain gages, piezometers, and joint meters.

Closure measurements are taken at convergence points. Rock displacement is calculated by measuring the distance between two opposing points. Displacement is monitored over time and is plotted as closure versus time. Annual rates of closure are calculated for the convergence data and are compared with annual closure rates from previous reporting periods.

Borehole extensometers are used to determine the absolute movements of the ground around the openings. With these instruments, rods or wires are placed into a hole and anchored at various depths. The displacement at the extensometer head (located near the excavation face) is measured relative to each of the fixed anchors. These data are used in the extensometer *displacement* plots presented here. As part of the post-processing of acquired extensometer data a *relative displacement* value is calculated. The deepest anchor is assumed to be fixed in undisturbed ground and a displacement for the remaining anchors relative to the deepest anchor is calculated. Annual rates of collar displacement are calculated for each extensometer and are compared with the annual displacement rate reported during the previous reporting period.

Rockbolt load cells are used to determine the ground loading and the effectiveness of rockbolts. Plots consist of load versus time for each instrumented bolt.

Earth pressure cells and strain gages are used in and around the shaft liners to determine their loads. These are also depicted in time-based plots. Monitoring of these instruments indicates whether there is any stress buildup in the shaft lining systems.

Piezometers are used to measure the gauge pressure of groundwater. They have been installed in the shafts at varying elevations to monitor the hydraulic head acting on the shaft liners. Plots from piezometers are presented as pressure versus time.

Joint meters are installed perpendicular to a crack and monitor any changes in separation of the crack which may

occur over time.

## **1.2 Data Plot Explanation**

Data are presented in graphical form for ease in interpretation. Time-based plots are used in this report. Each plot generally consists of a legend in the upper right-hand corner that gives the array name and specific location of the instrument or point evaluated. The legend ties the graphical cross-sectional representation of the drift or shaft typically presented in the lower right-hand corner to the symbols on the curve in the graph. For extensometers, each anchor is designated with an alpha character “A” closest to the collar and “C,” “D,” or “E” for the furthest point from the collar (the deepest anchor). For convergence points, the horizontal and vertical sections of the drift are referred to as chords. Breaks in the graph for convergence data and a numeric designator added to the legend typically indicate that the convergence point was lost due to normal mine maintenance activities and later reinstalled.

## **1.3 Report Organization**

Chapter 1.0 provides an introduction to this Supporting Data volume of the GAR. Chapter 2.0 provides instrument data analysis for the Salt Handling Shaft, Waste Shaft, and Exhaust Shaft followed by data plots for the extensometers, piezometers, earth pressure cells, spot welded strain gages, and embedment strain gages installed in the shafts. Chapter 3.0 provides instrument data analysis for the Salt Handling Shaft Station and Waste Shaft Station, an instrument data summary only for the area immediately surrounding the Air Intake Shaft, and data plots for extensometers, convergence points, and rockbolt load cells for all three locations. Chapter 4.0 provides instrument data analysis for the access drifts followed by data plots for the extensometers, convergence points, joint meters and rock bolt load cells. Chapter 5.0 provides instrument data analysis for the Waste Disposal Area followed by data plots for the extensometers, rock bolt load cells and convergence points.

Chapter 6.0 provides geologic data collected through the mapping of fractures and the observed displacements in vertical boreholes.

## ***2.0 Instrumentation Summary for Shafts***

Instrumentation data analysis for three of the four shafts at the WIPP follows. Table 2-1 presents data and analysis of the Salt Shaft. Plots of the instrument data are presented as Figures 2-1 through 2-13. Table 2-2 presents data and analysis of the Waste Shaft. Plots of the instrument data are presented as Figures 2-14 through 2-20. Table 2-3 presents data and analysis of the Exhaust Shaft. Plots of the instrument data are presented as Figures 2-21 through 2-27.

**Table 2-1  
Salt Handling Shaft Data Analysis**

**PIEZOMETERS**

Field Tag	Level feet	Figure Number	Date of 2006-2007 Max. Reading	2006-2007 Maximum Pressure Reading (psi)	Date of 2005-2006 Max. Reading	2005-2006 Maximum Pressure Reading (psi)	Change in Maximum Pressure From Previous Year (psi)	Comments
37X-PE-00201	580	2-1	04/02/07	91	05/01/06	101	-11	
37X-PE-00202	580	2-1	04/02/07	97	05/01/06	108	-10	
37X-PE-00203	620	2-2	04/02/07	173	04/06/06	229	-57	Noisy transducer.
37X-PE-00204	620	2-2	04/02/07	155	04/06/06	184	-29	Noisy transducer.
37X-PE-00205	691	2-3	07/20/06	177	04/06/06	170	7	
37X-PE-00206	691	2-3	07/20/06	170	04/06/06	166	4	
37X-PE-00207	726	2-4	12/04/06	146	12/05/05	144	2	
37X-PE-00209	802	2-5	07/20/06	71	08/01/05	74	-3	
37X-PE-00210	802	2-5	10/02/06	70	09/02/05	74	-4	
37X-PE-00211	850	2-6	06/04/07	127	04/06/06	129	-2	
37X-PE-00212	850	2-6	06/04/07	140	04/06/06	140	0	

**EARTH PRESSURE CELLS**

Field Tag	Level feet	Figure Number	Date of 2006-2007 Max. Reading	2006-2007 Maximum Pressure Reading (psi)	Date of 2005-2006 Max. Reading	2005-2006 Maximum Pressure Reading (psi)	Change in Maximum Pressure From Previous Year (psi)	Comments
37X- WE-00201	860	2-7	07/20/06	-7	09/02/05	-7	0	
37X- WE-00202	860	2-7	07/20/06	-22	07/11/05	-22	-1	
37X- WE-00203	860	2-7	05/07/07	5	04/06/06	3	2	

**Table 2-1 (Continued)  
Salt Handling Shaft Data Analysis**

**SPOT WELDED STRAIN GAGES**

Field Tag	Level feet	Figure Number	Date of 2006-2007 Max. Reading	2006-2007 Maximum Total Microstrain	Date of 2005-2006 Max. Reading	2005-2006 Maximum Total Microstrain	Change in Maximum Strain From Previous Year	Comments
37X-ZE-00201	856.3	2-8	08/07/06	739	07/11/05	748	21	
37X-ZE-00206	856.3	2-8	07/20/06	672	07/11/05	668	-9	
37X-ZE-00220	862.4	2-9	09/05/06	856	12/05/05	829	4	
37X-ZE-00223	862.4	2-9	07/20/06	620	07/11/05	591	23	

**EMBEDMENT STRAIN GAGES**

Field Tag	Level feet	Figure Number	Date of 2006-2007 Max. Reading	2006-2007 Maximum Total Microstrain	Date of 2005-2006 Max. Reading	2005-2006 Maximum Total Microstrain	Change in Maximum Strain From Previous Year	Comments
37X-ZE-00209	856.3	2-10	02/05/07	-559	01/03/06	-554	-5	
37X-ZE-00210	856.3	2-10	07/20/06	999	07/11/05	984	15	
37X-ZE-00211	856.3	2-10	07/20/06	328	07/11/05	328	0	
37X-ZE-00212	856.3	2-10	12/04/06	-826	12/05/05	-810	-16	
37X-ZE-00213	856.3	2-10	07/20/06	347	07/11/05	339	8	
37X-ZE-00214	856.3	2-10	12/04/06	-130	12/05/05	-121	-9	
37X-ZE-00215	856.3	2-10	07/20/06	103	07/11/05	95	8	
37X-ZE-00216	856.3	2-10	07/20/06	614	07/11/05	589	25	
37X-ZE-00225	862.4	2-11	07/20/06	217	07/11/05	200	17	
37X-ZE-00235	856.3	2-12	02/05/07	-436	01/03/06	-424	-12	
37X-ZE-00236	856.3	2-12	07/20/06	122	07/11/05	101	21	
37X-ZE-00237	856.3	2-12	07/20/06	106	07/11/05	86	20	
37X-ZE-00238	856.3	2-12	07/20/06	511	07/11/05	493	18	
37X-ZE-00239	862.4	2-13	07/20/06	358	07/11/05	340	18	



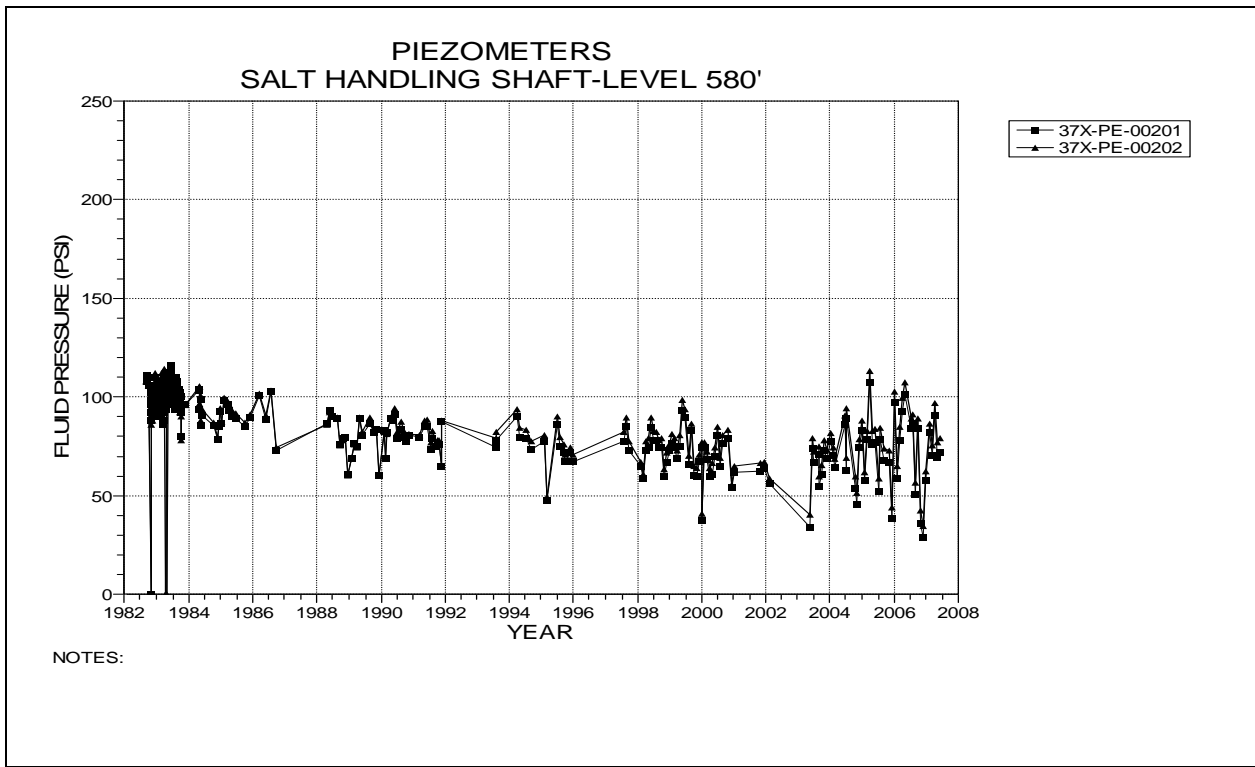


Figure 2-1 Piezometers 37X-PE-00201 and 37X-PE-00202  
Salt Handling Shaft – Level 580 at the Forty-niner Member

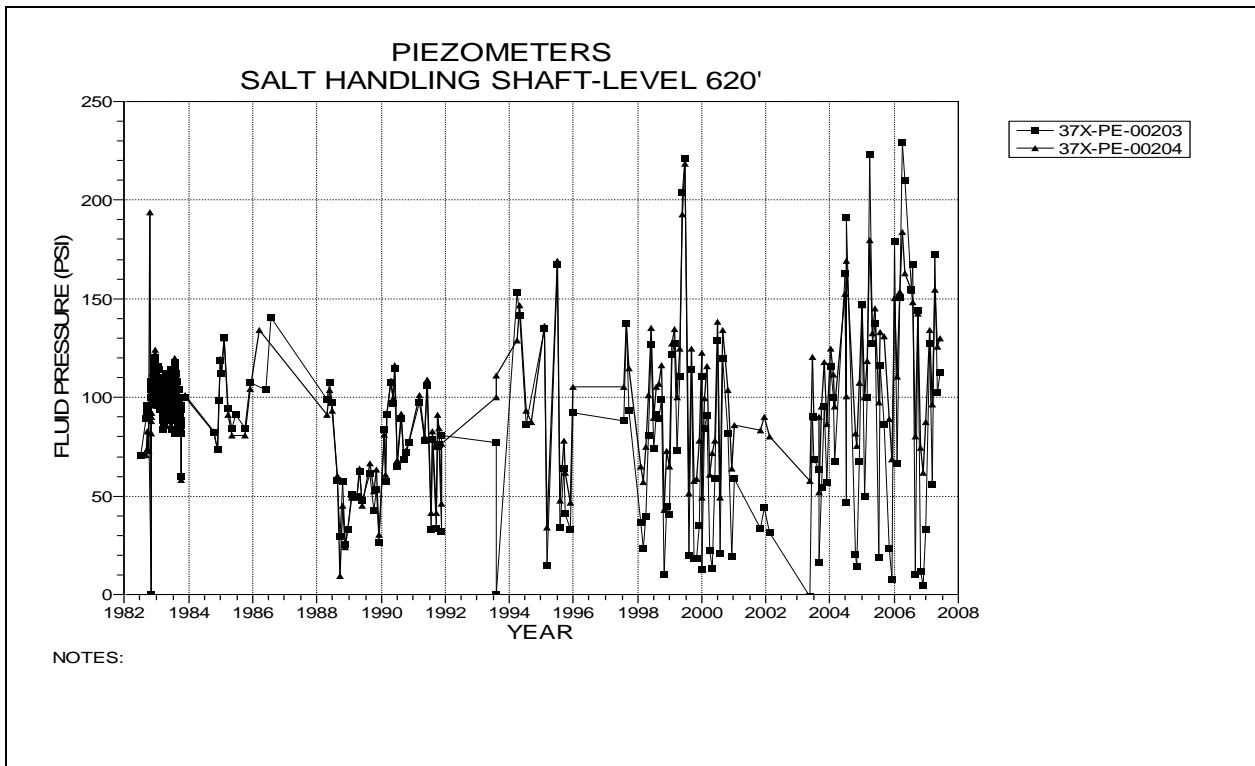


Figure 2-2 Piezometers 37X-PE-00203 and 37X-PE-00204  
Salt Handling Shaft – Level 620 at the Magenta Dolomite Member

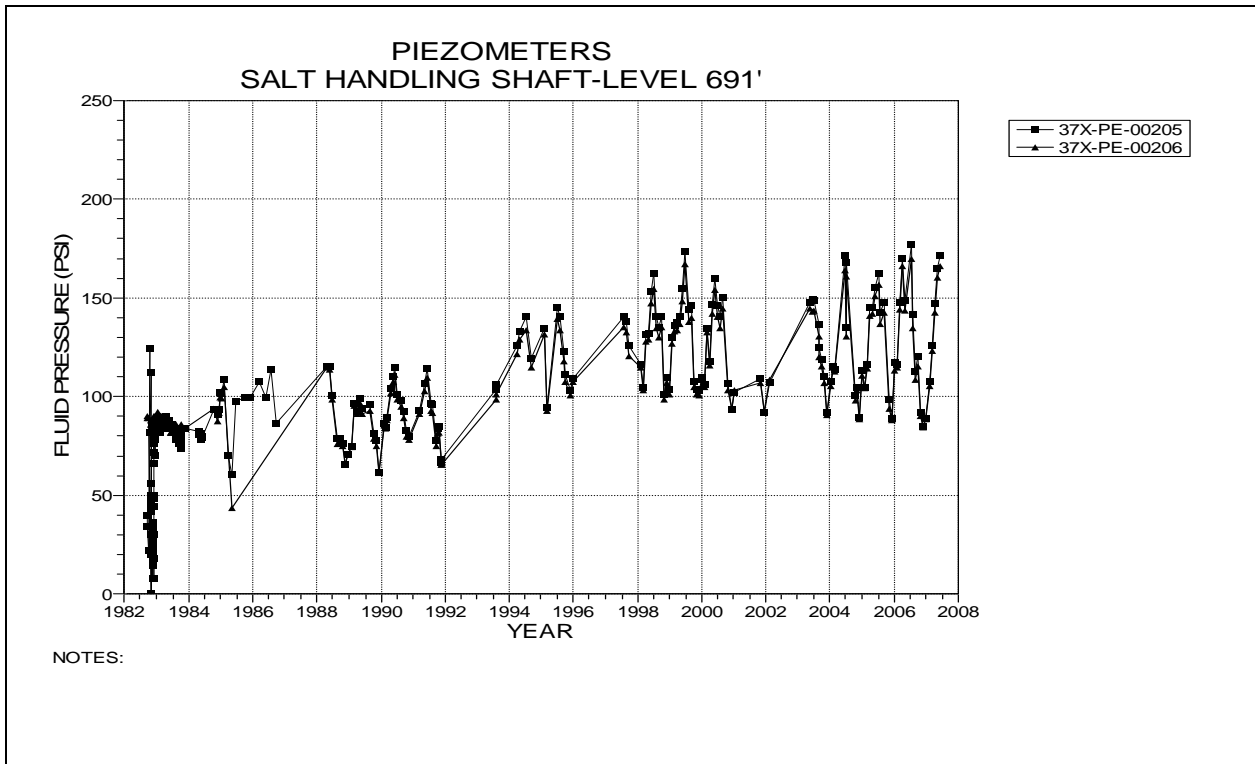


Figure 2-3 Piezometers 37X-PE-00205 and 37X-PE-00206  
Salt Handling Shaft – Level 691 at the Tamarisk Member

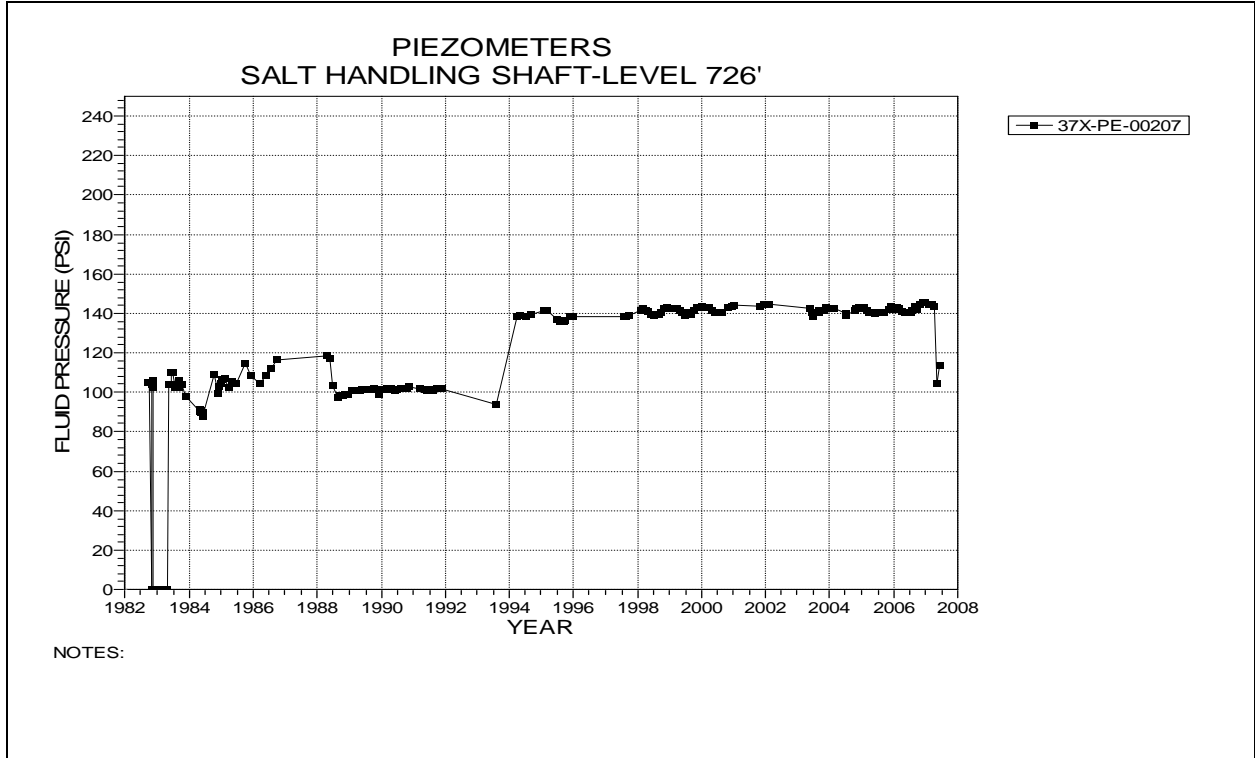


Figure 2-4 Piezometer 37X-PE-00207  
Salt Handling Shaft – Level 726 at the Culebra Dolomite Member

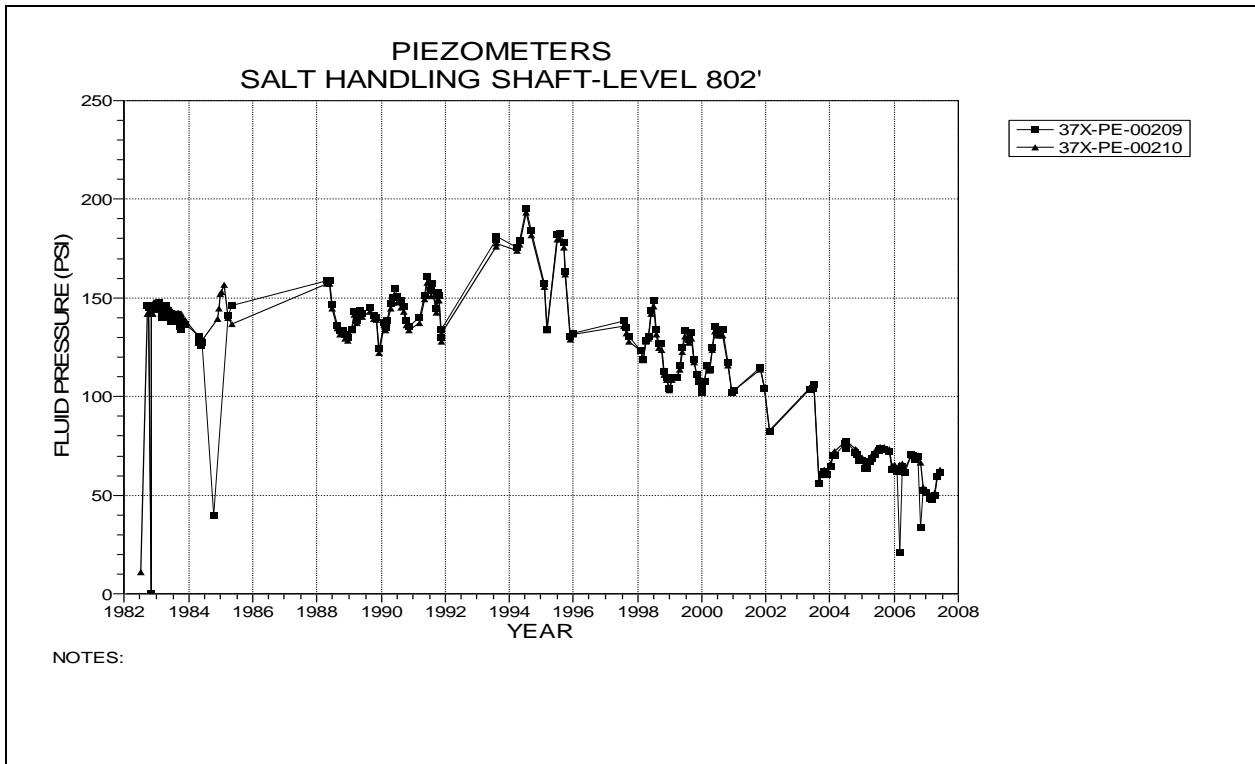


Figure 2-5 Piezometers 37X-PE-00209 and 37X-PE-00210  
Salt Handling Shaft – Level 802 at the Los Medaños Member

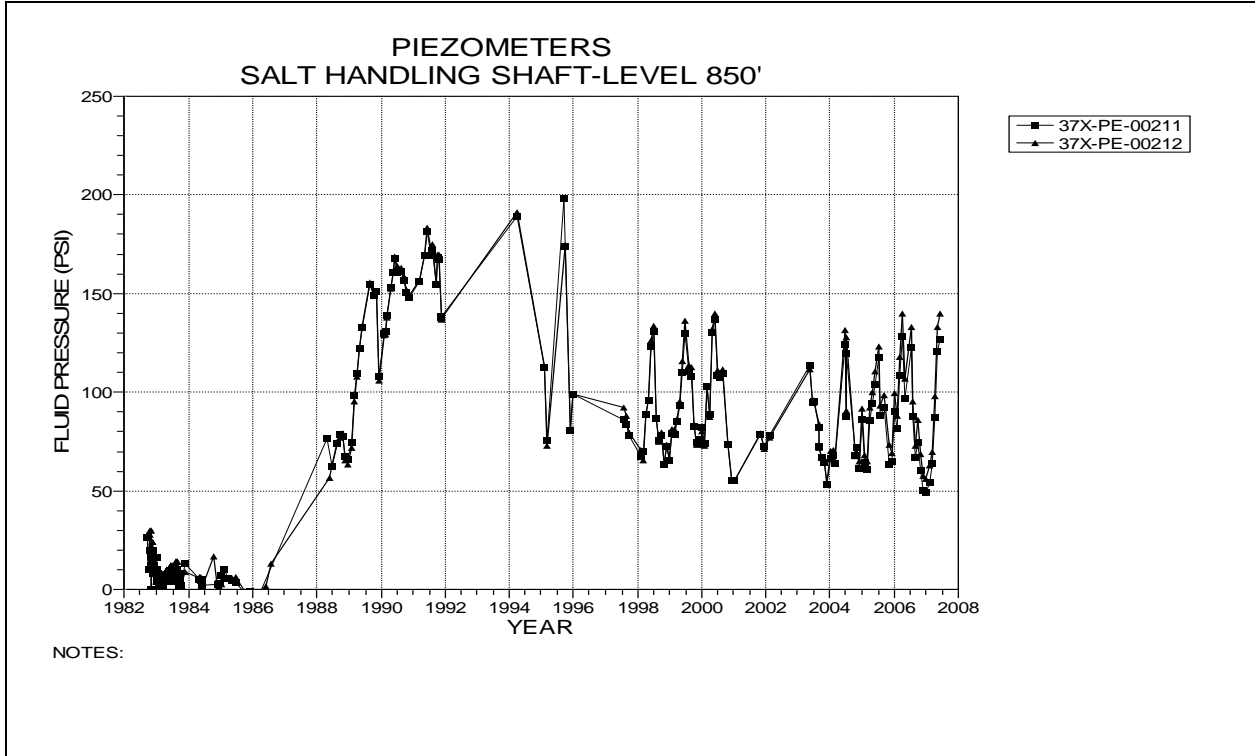


Figure 2-6 Piezometers 37X-PE-00211 and 37X-PE-00212  
Salt Handling Shaft – Level 850 at the Rustler-Salado Contact

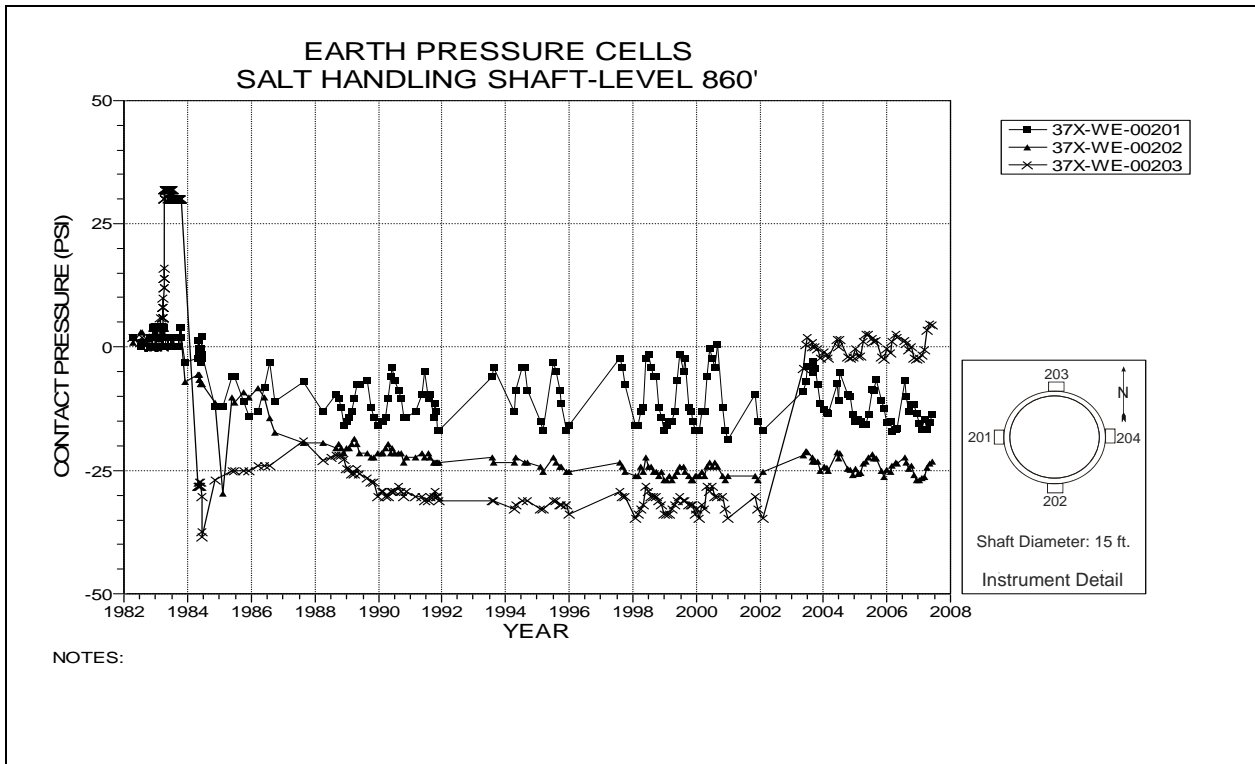


Figure 2-7 Earth Pressure Cells Behind Shaft Key  
Salt Handling Shaft Key – Level 860

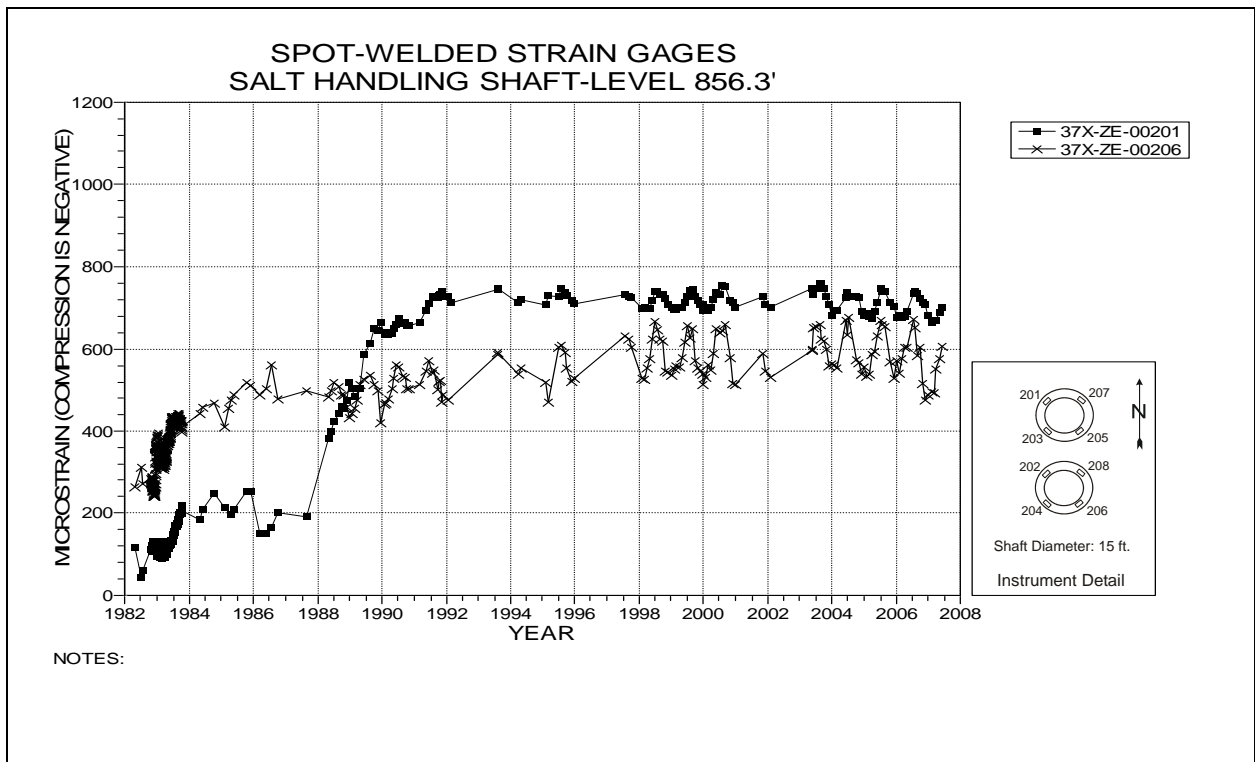


Figure 2-8 Spot-Welded Strain Gages  
Salt Handling Shaft Key – Level 856.3

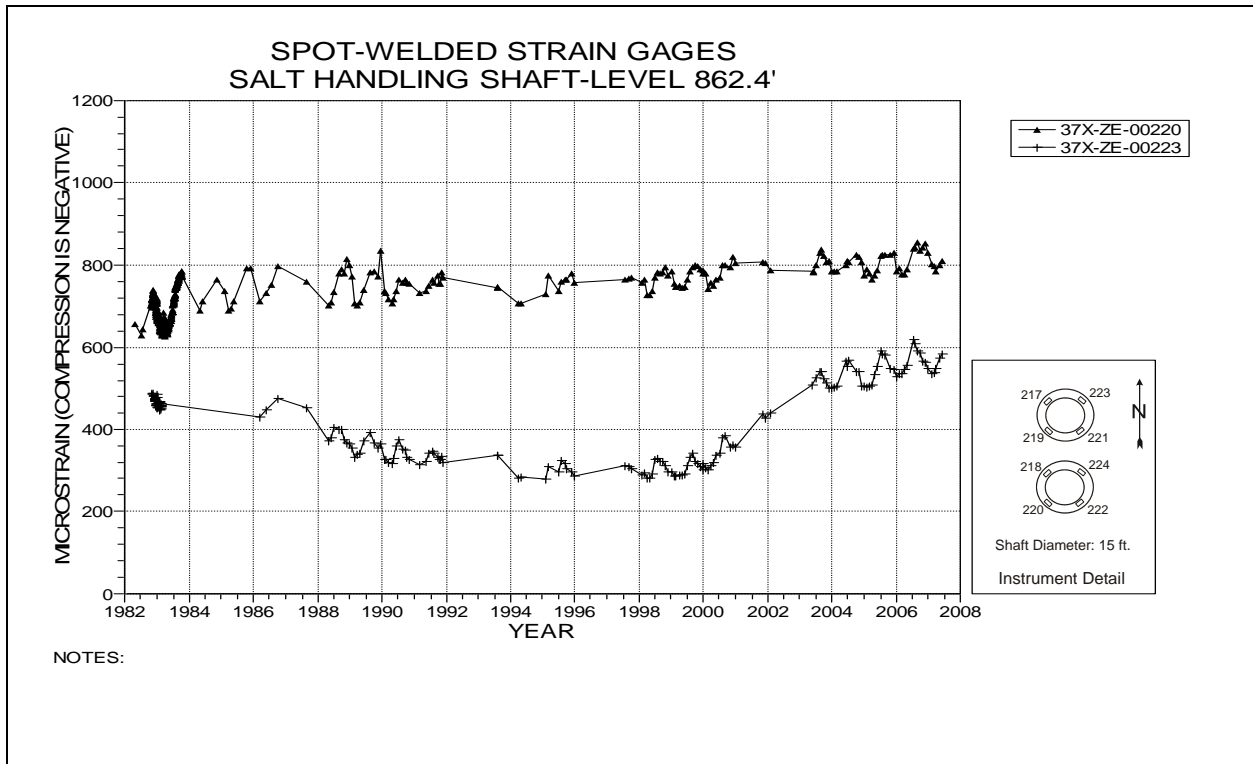


Figure 2-9 Spot-Welded Strain Gages  
Salt Handling Shaft Key – Level 862.4

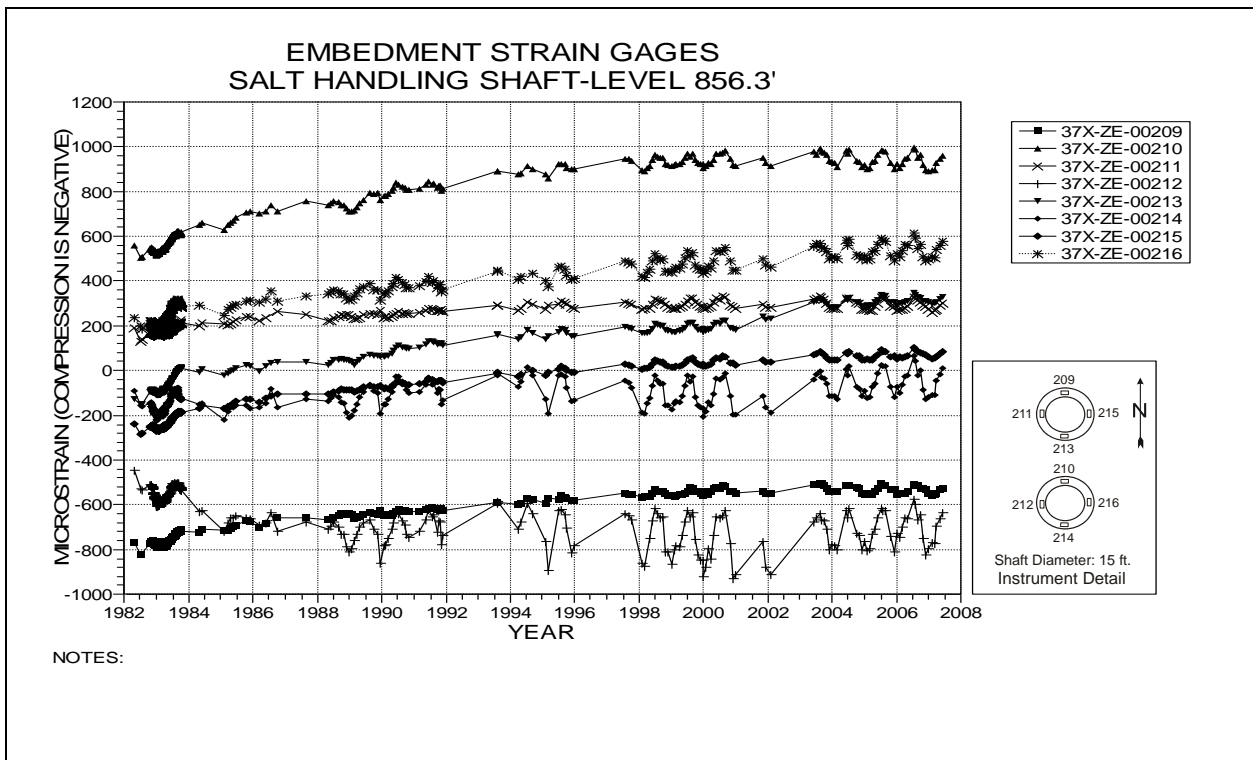


Figure 2-10 Embedment Strain Gages  
Salt Handling Shaft Key – Level 856.3

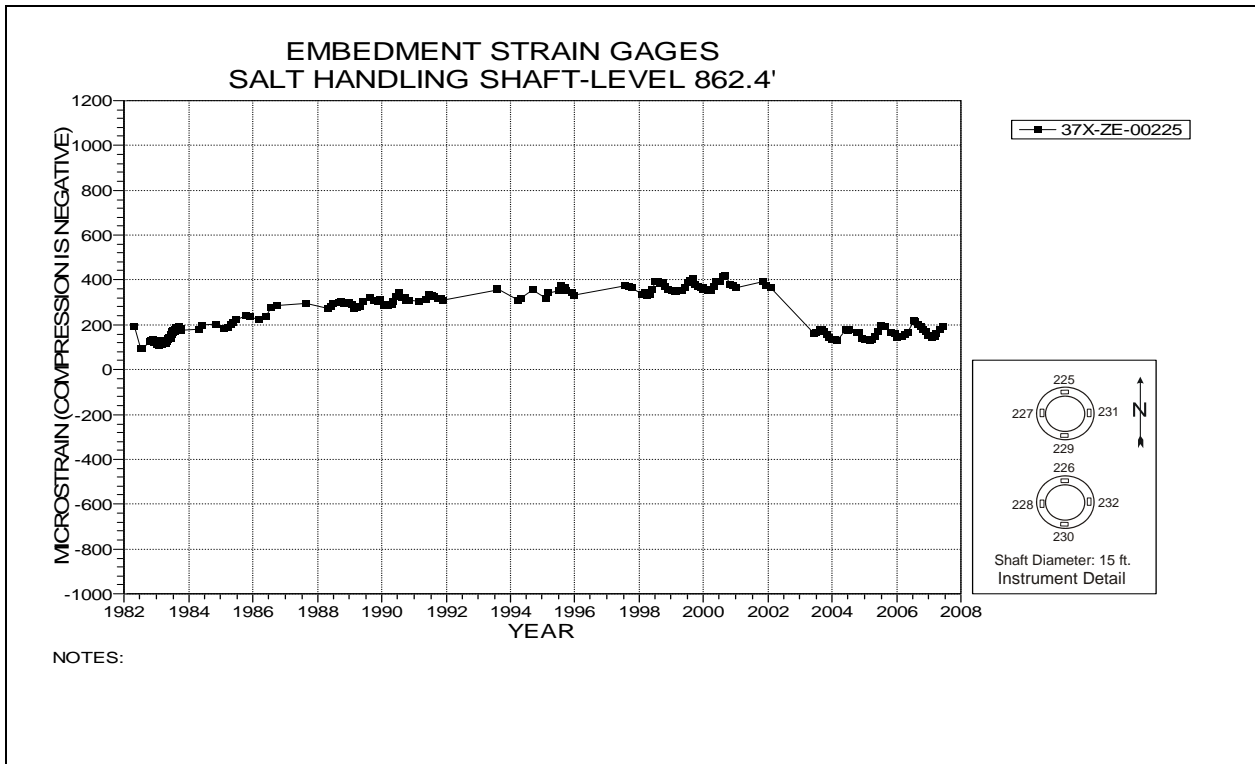


Figure 2-11 Embedment Strain Gage  
Salt Handling Shaft Key Level 862.4

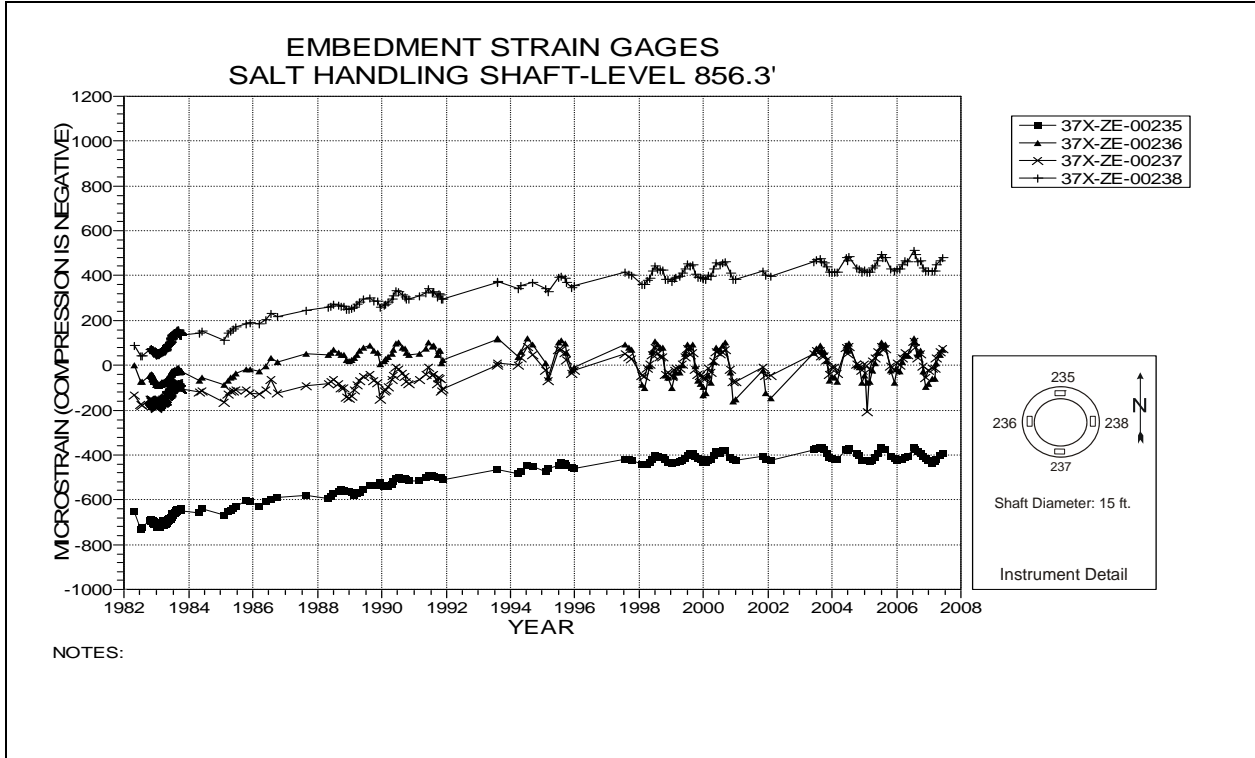


Figure 2-12 Embedment Strain Gages  
Salt Handling Shaft Key Level 856.3

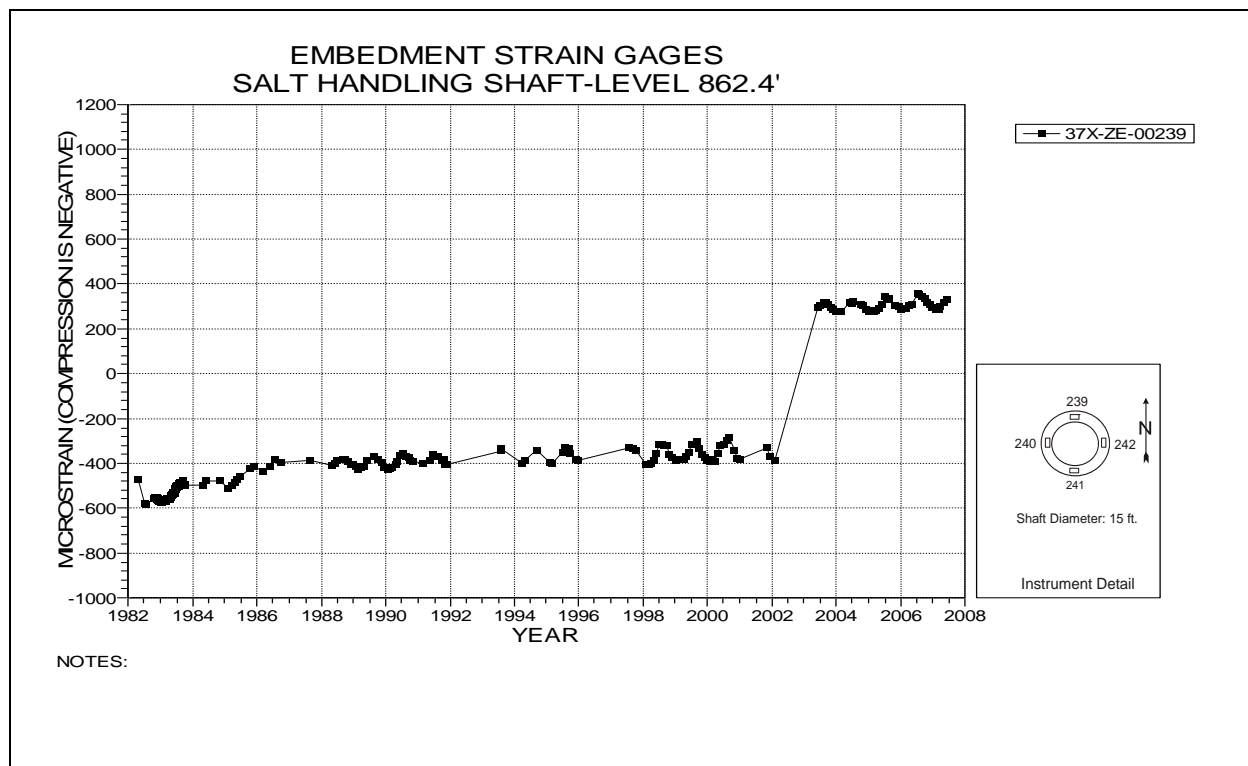


Figure 2-13 Embedment Strain Gages  
Salt Handling Shaft Key – Level 862.4

**Table 2-2  
Waste Shaft Data Analysis**

**PIEZOMETERS**

Field Tag	Level Feet	Figure Number	Date of 2006-2007 Max. Reading	2006-2007 Maximum Pressure Reading (psi)	Date of 2005-2006 Max. Reading	2005-2006 Maximum Pressure Reading (psi)	Change in Maximum Pressure From Previous Year (psi)	Comments
31X-PE-00202	532	2-14	06/28/07	-4	09/02/05	-4	0	
31X-PE-00203	611	2-15	06/28/07	36	09/02/05	36	0	
31X-PE-00204	611	2-15	06/28/07	14	09/02/05	11	3	
31X-PE-00205	669	2-16	04/17/07	0	01/03/06	0	0	
31X-PE-00206	669	2-16	06/28/07	-1	04/27/06	-1	0	
31X-PE-00208	717	2-17	06/28/07	141	09/02/05	138	3	
31X-PE-00209	758	2-18	06/28/07	48	09/02/05	47	1	
31X-PE-00210	758	2-18	06/28/07	0	04/27/06	1	-1	
31X-PE-00211	845	2-19	05/31/07	60	09/02/05	74	-14	
31X-PE-00212	845	2-19	06/28/07	73	09/02/05	80	-7	

**EARTH PRESSURE CELLS**

Field Tag	Level Feet	Figure Number	Date of 2006-2007 Max. Reading	2006-2007 Maximum Pressure Reading (psi)	Date of 2005-2006 Max. Reading	2005-2006 Maximum Pressure Reading (psi)	Change in Maximum Pressure From Previous Year (psi)	Comments
31X- WE-00201	866	2-20	06/28/07	76	09/02/05	84	-8	
31X- WE-00203	866	2-20	06/28/07	107	08/17/05	110	-3	
31X- WE-00204	866	2-20	06/28/07	92	09/02/05	100	-8	



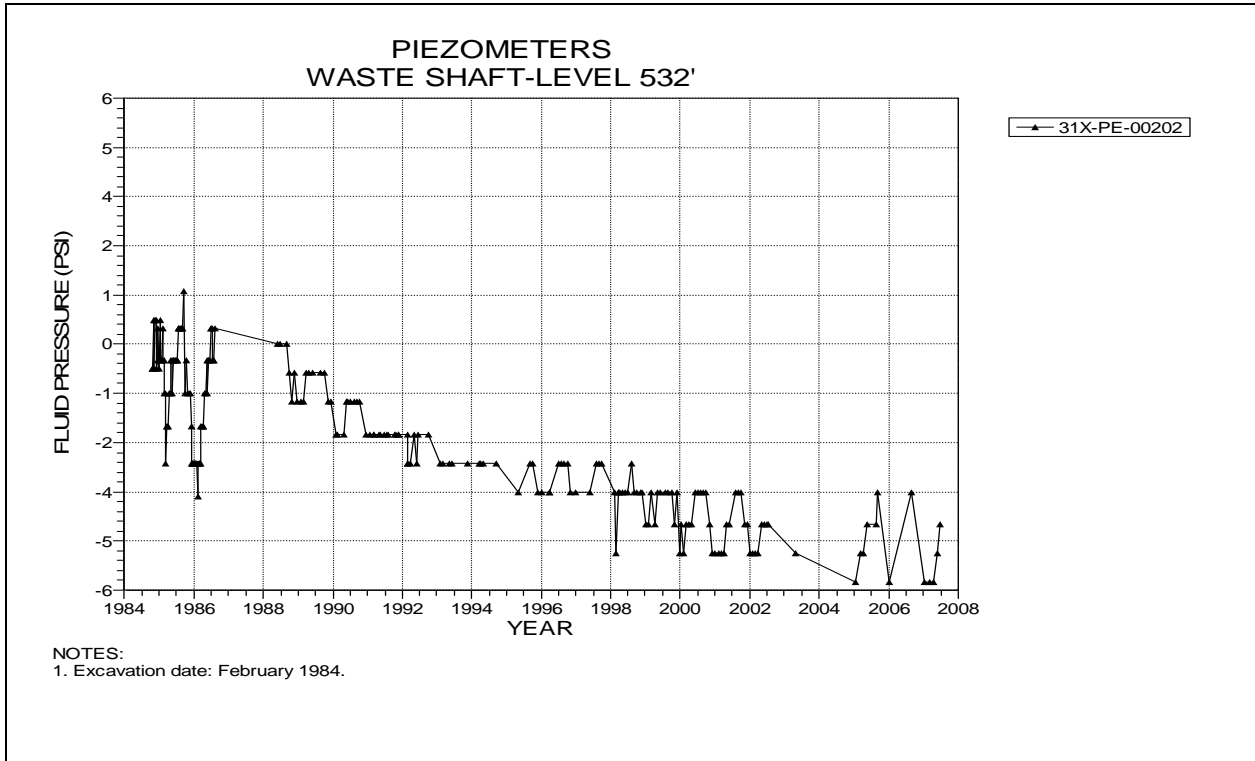


Figure 2-14 Piezometer 31X-PE-00202  
Waste Shaft – Level 532 at the Base of Dewey Lake Redbeds

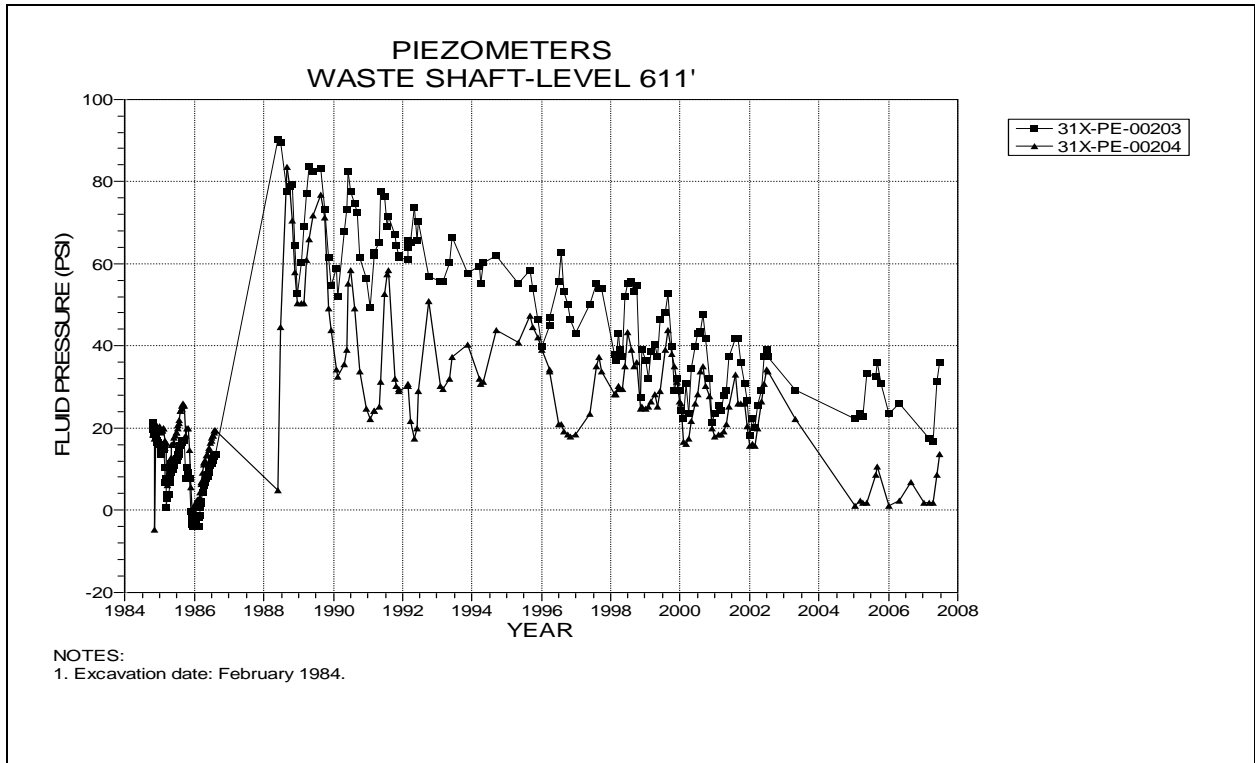


Figure 2-15 Piezometers 31X-PE-00203 and 31X-PE-00204  
Waste Shaft – Level 611 at the Magenta Dolomite Member

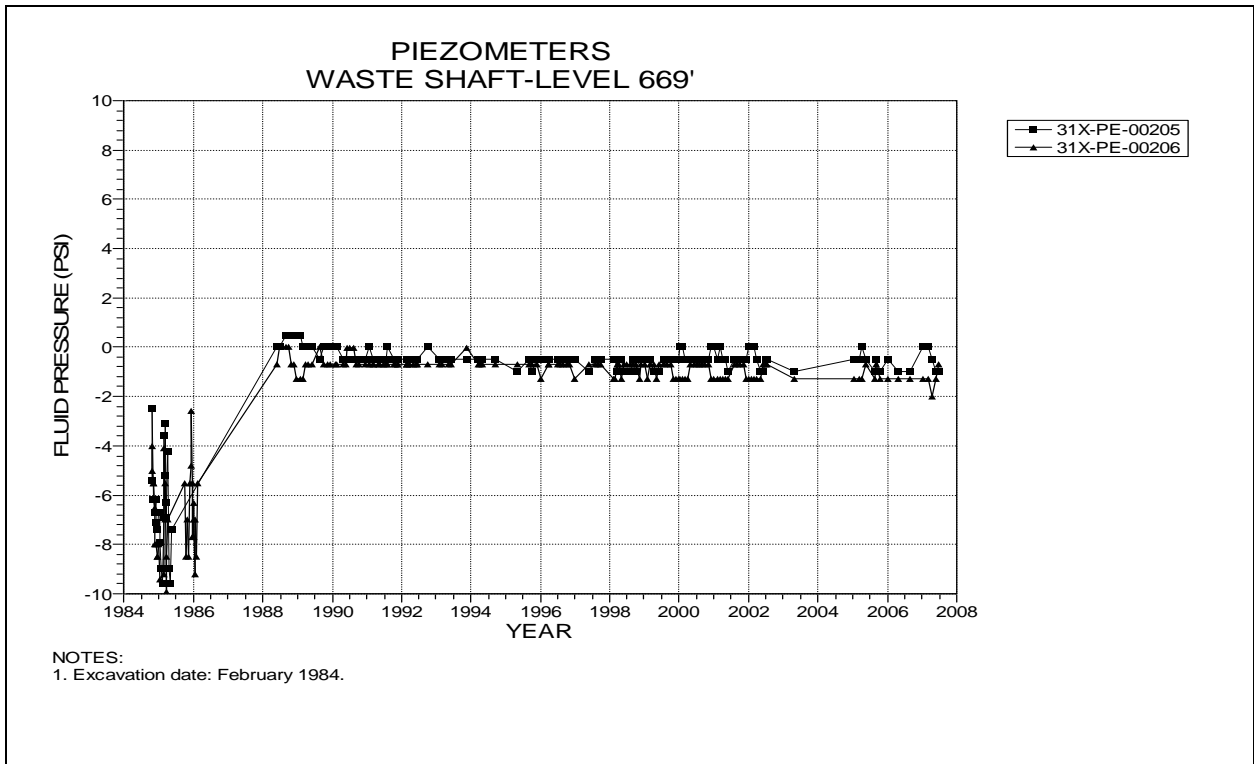


Figure 2-16 Piezometers 31X-PE-00205 and 31X-PE-00206  
Waste Shaft – Level 669 at the Tamarisk Member

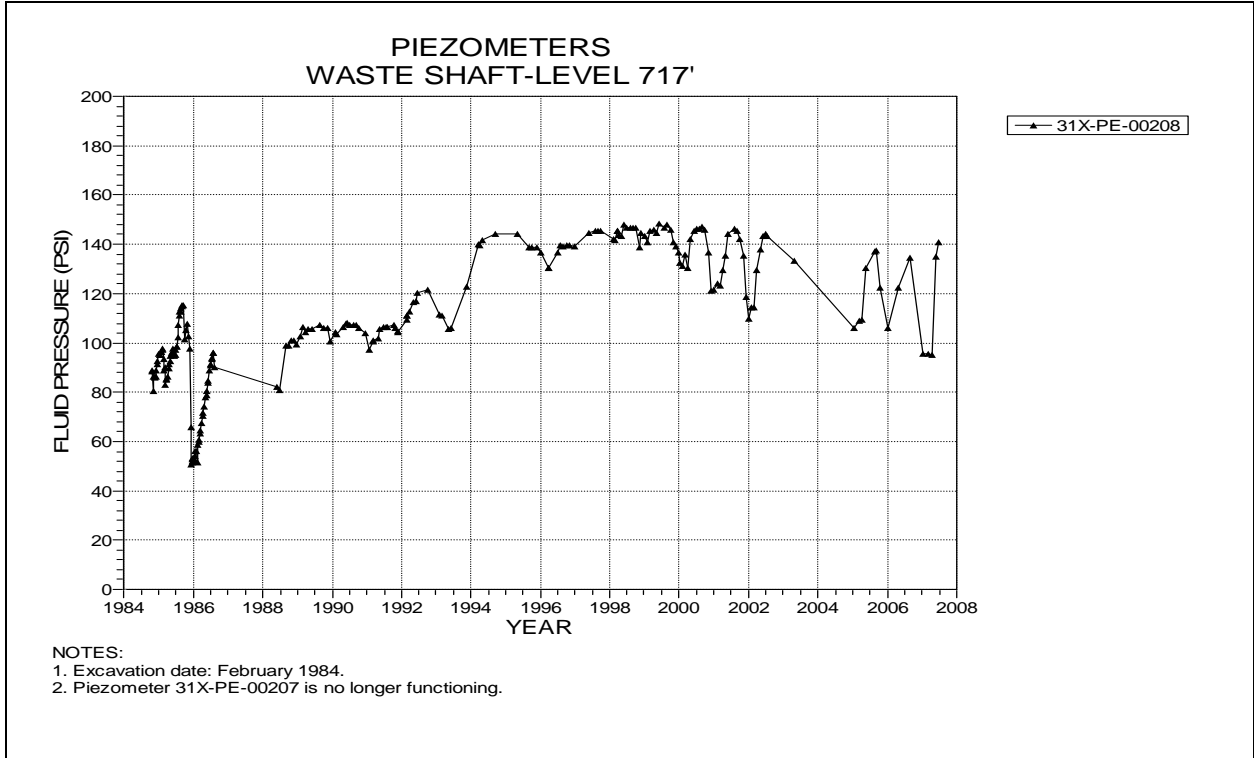


Figure 2-17 Piezometer 31X-PE-00208  
Waste Shaft – Level 717 at the Culebra Dolomite Member

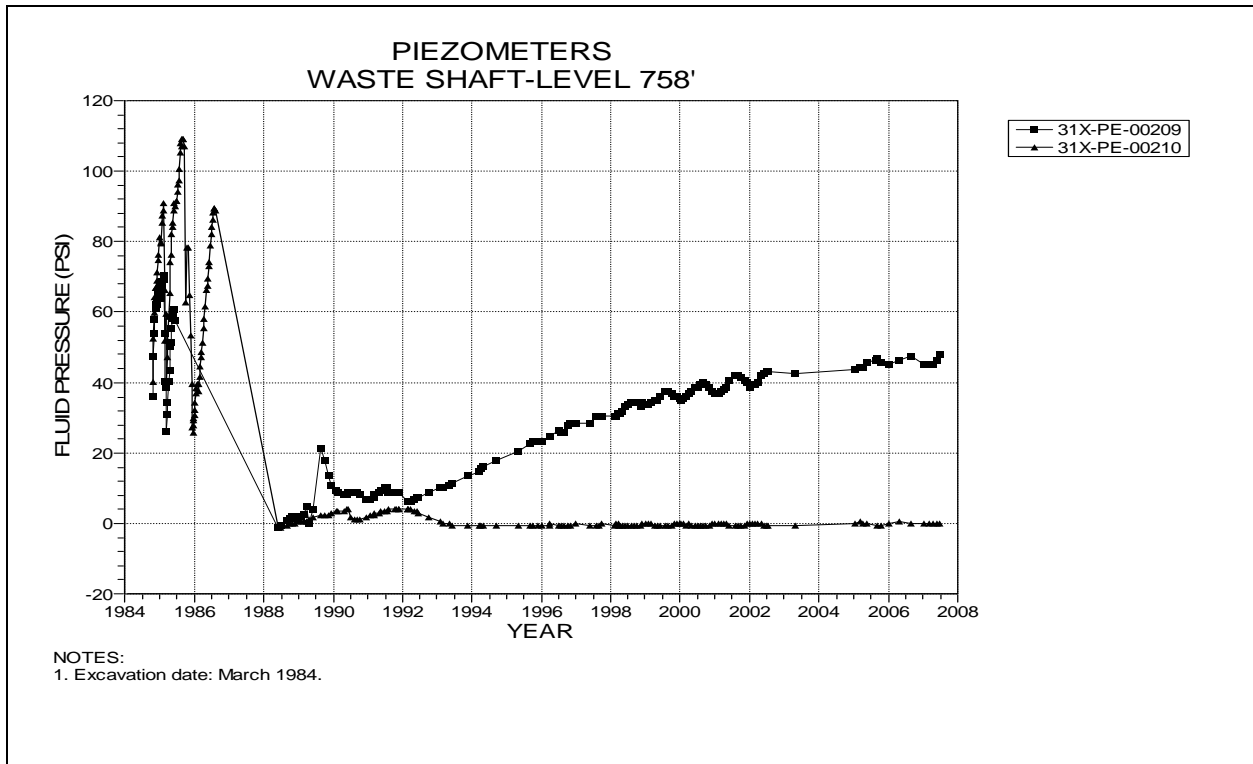


Figure 2-18 Piezometers 31X-PE-00209 and 31X-PE-00210  
Waste Shaft – Level 758 at the Los Medaños Member

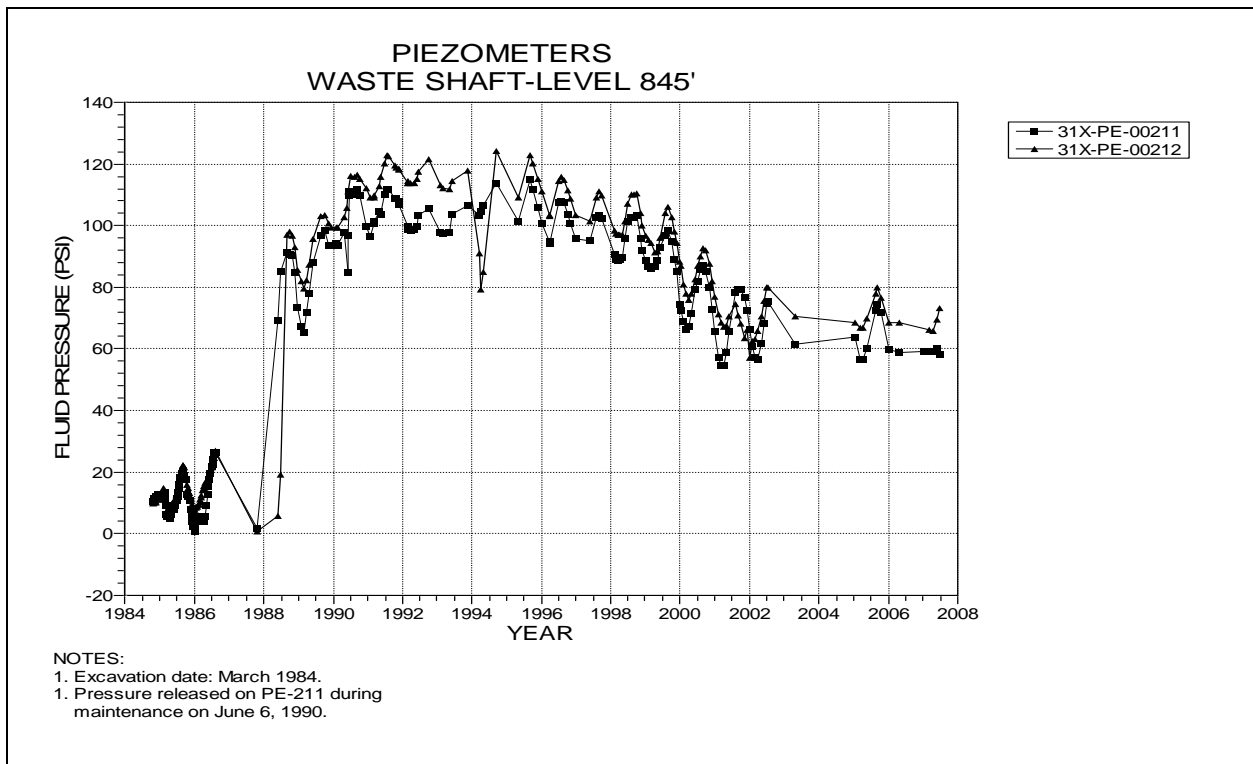


Figure 2-19 Piezometers 31X-PE-00211 and 31X-PE-00212  
Waste Shaft – Level 845 at the Rustler-Salado Contact

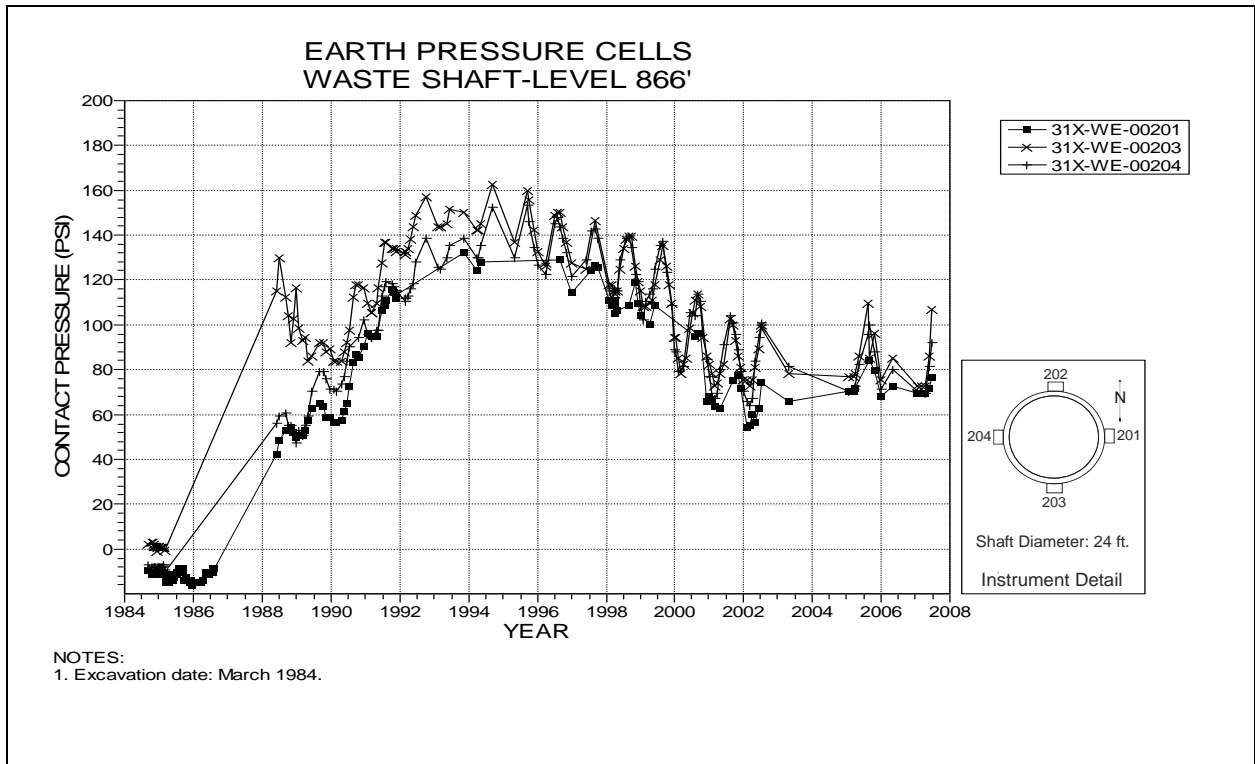


Figure 2-20 Earth Pressure Cells  
Waste Shaft Key – Level 866

**Table 2-3  
Exhaust Shaft Data Analysis**

**PIEZOMETERS**

Field Tag	Level feet	Figure Number	Date of 2006-2007 Max. Reading	2006-2007 Maximum Pressure Readings (psi)	Date of 2005-2006 Max. Reading	2005-2006 Maximum Pressure Readings (psi)	Change in Maximum Pressure From Previous Year (psi)	Comments
35X-PE-00202	544	2-21	09/05/06	-2	10/03/05	-2	0	
35X-PE-00204	615	2-22	11/02/06	126	06/19/06	126	0	
35X-PE-00208	673	2-23	11/02/06	6	06/19/06	6	0	
35X-PE-00210	721	2-24	06/04/07	141	06/19/06	141	0	
35X-PE-00213	768	2-25	11/02/06	8	06/19/06	9	-1	
35X-PE-00214	768	2-25	08/07/06	7	06/19/06	6	1	
35X-PE-00216	850	2-26	10/02/06	86	06/12/06	88	-2	
35X-PE-00218	850	2-26	06/04/07	31	06/12/06	21	10	
35X-PE-00219	887	2-27	11/02/06	29	10/03/05	29	0	

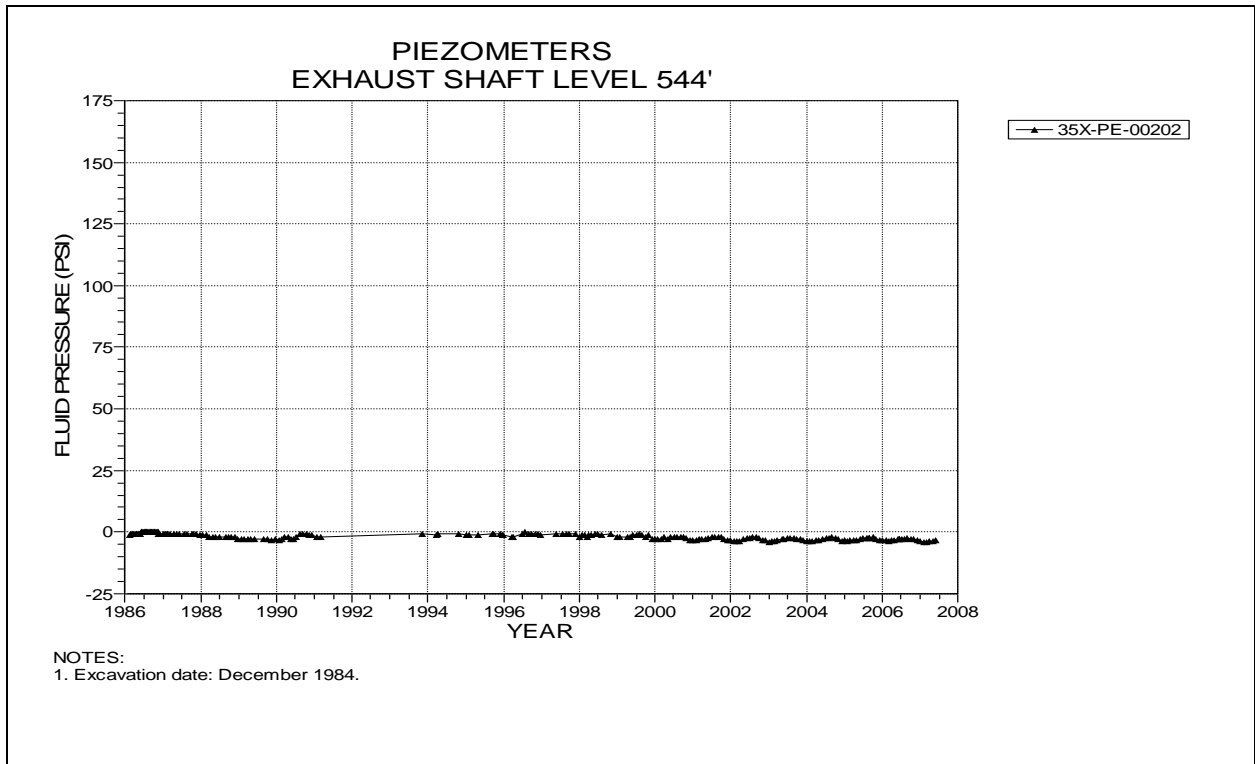


Figure 2-21 Piezometer 35X-PE-00202  
Exhaust Shaft – Level 544 at the Base of Dewey Lake Redbeds

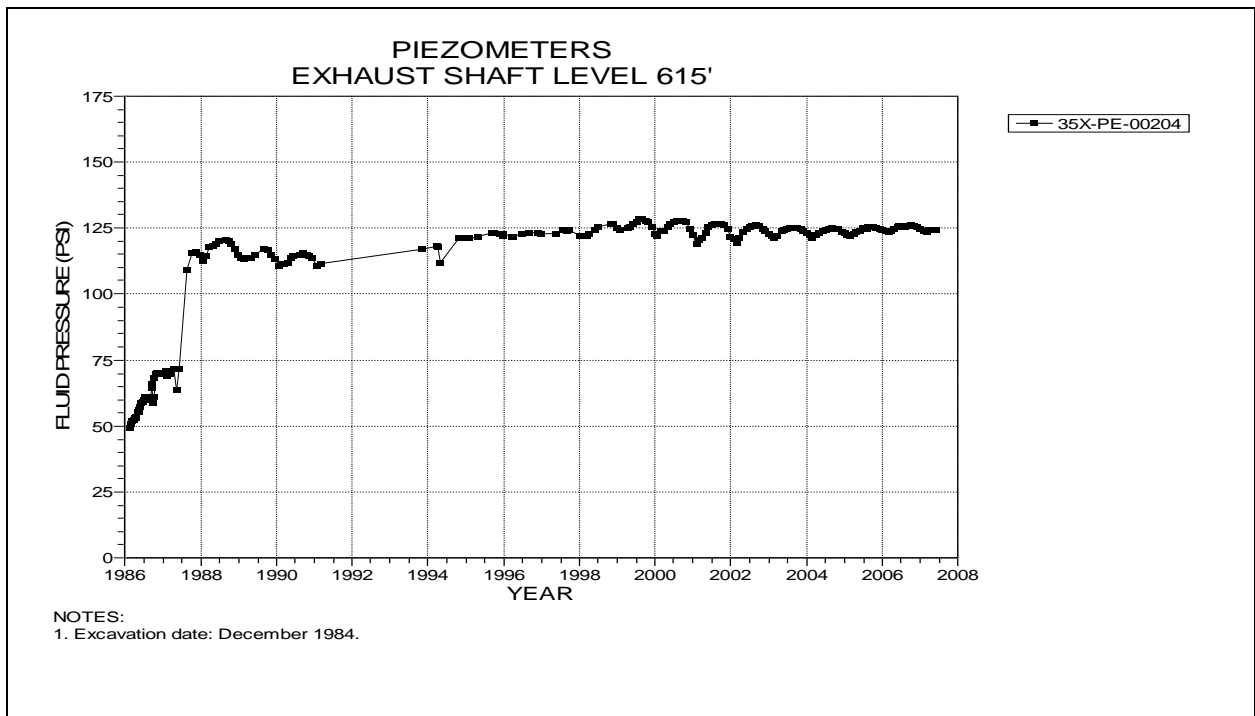


Figure 2-22 Piezometer 35X-PE-00204  
Exhaust Shaft – Level 615 at the Magenta Dolomite Member

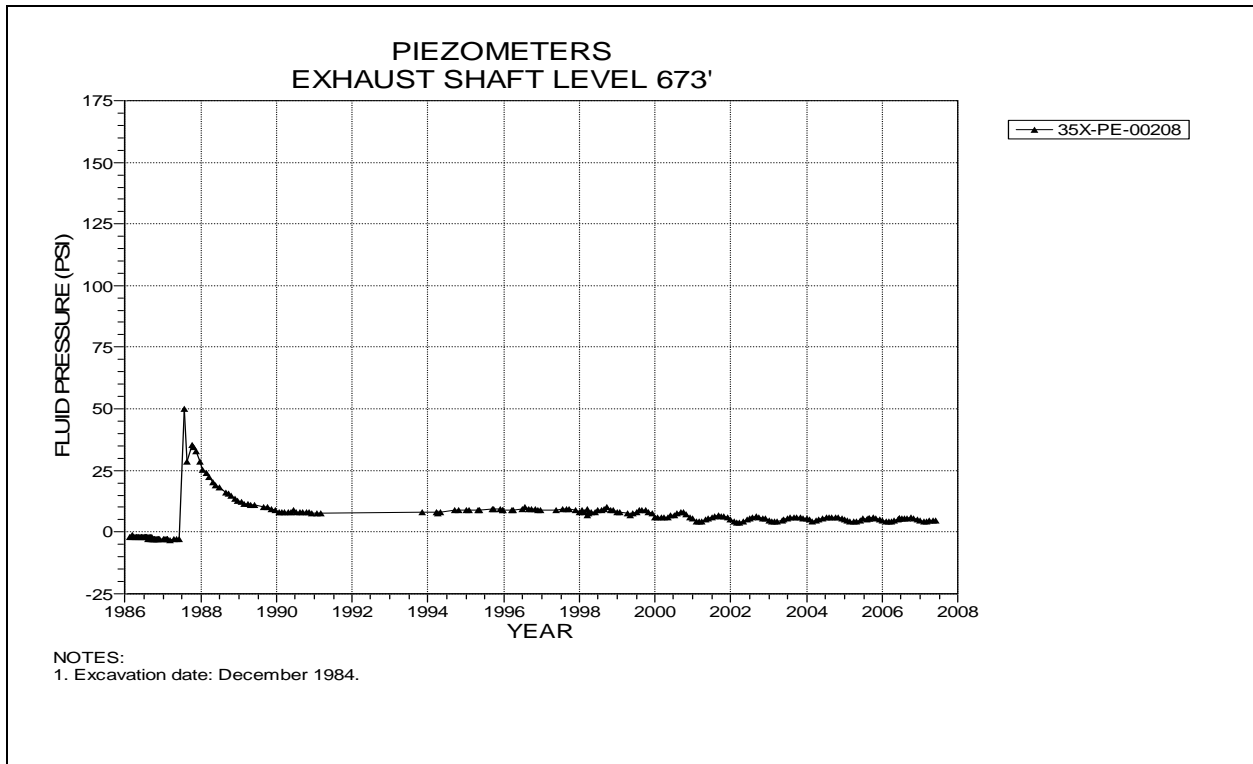


Figure 2-23 Piezometer 35X-PE-00208  
Exhaust Shaft – Level 673 at the Tamarisk Member

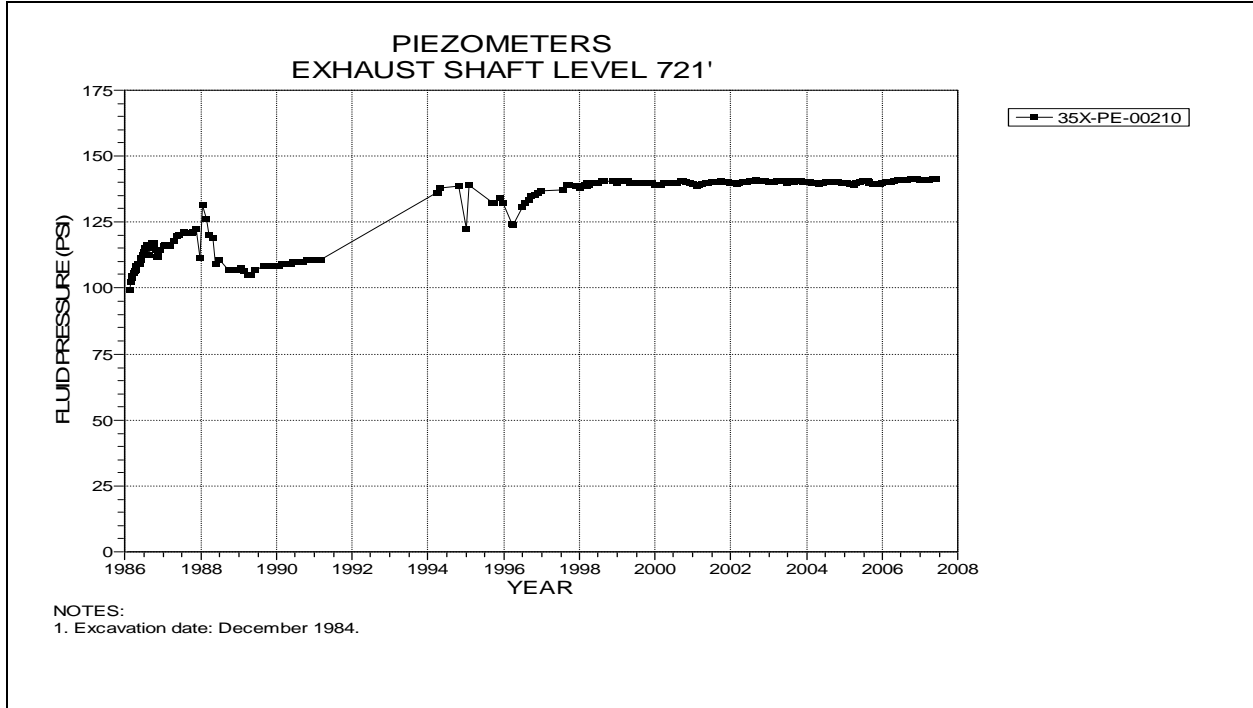


Figure 2-24 Piezometer 35X-PE-00210  
Exhaust Shaft – Level 721 at the Culebra Dolomite Member

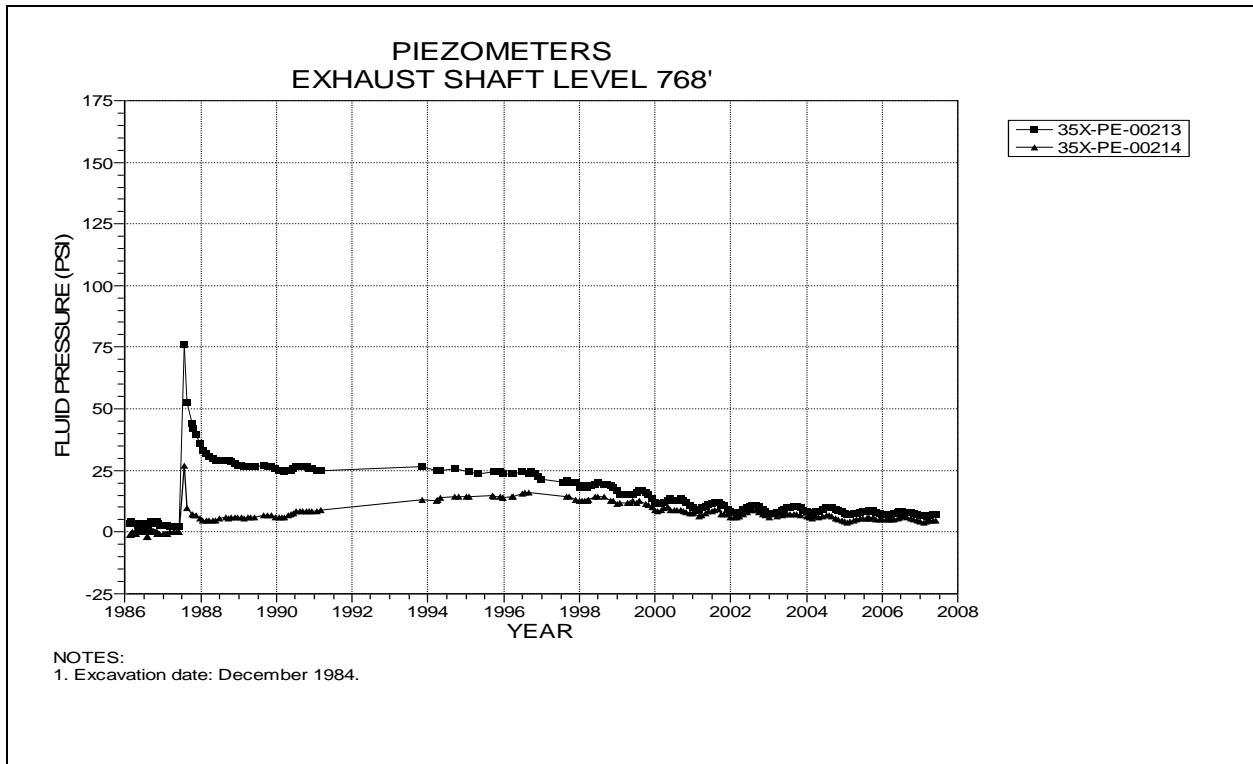


Figure 2-25 Piezometers 35X-PE-00213 and 35X-PE-00214  
Exhaust Shaft – Level 768 at the Los Medaños Member

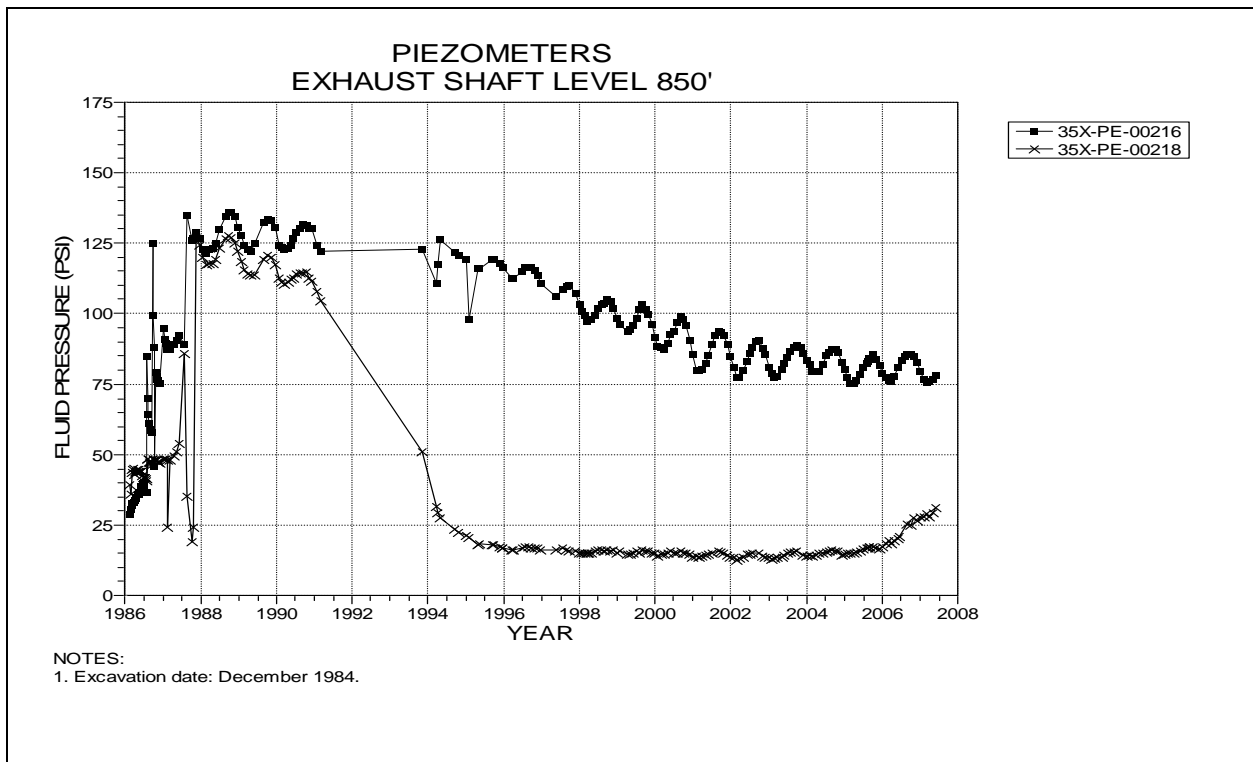


Figure 2-26 Piezometers 35X-PE-00216 and 35X-PE-00218  
Exhaust Shaft – Level 850 at the Rustler-Salado Contact



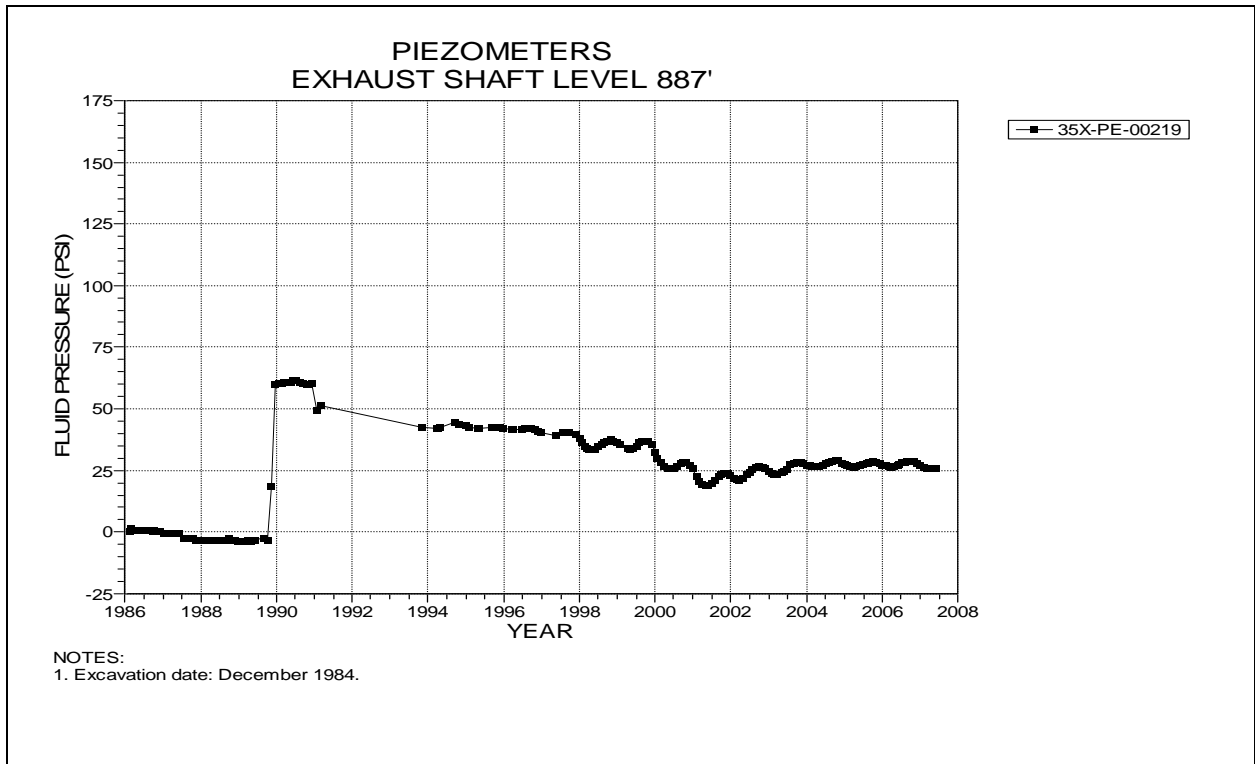


Figure 2-27 Piezometer 35X-PE-00219  
Exhaust Shaft – Level 887 below the Lower Chemical Seal

### ***3.0 Instrumentation Summary for Shaft Stations***

---

Instrumentation data analysis for the Salt Handling Shaft Station, Waste Shaft Station, and the area around the Air Intake Shaft follow. Table 3-1 presents data analyses for each of the Salt Handling Shaft Station instruments. Figures 3-1 through 3-3 present plots of the instrumentation data for the Salt Handling Shaft Station. Table 3-2 presents data and analysis for the Waste Shaft Station. Plots from the instrumentation in the Waste Shaft Station are presented as Figures 3-4 through 3-12. Table 3-3 and Figures 3-13 through 3-18 present the data from rock bolt load cells and borehole extensometers located in the immediate area around the Air Intake Shaft.

**Table 3-1**  
**Salt Handling Shaft Station Data Analysis**

**CONVERGENCE POINTS**

Field Tag	Location	Figure Number	Last Reading 2006-2007		Cumulative Displacement (inches)	Closure Rate 2006 to 2007 (in/year)	Closure Rate 2005 to 2006 (in/year)	Rate Change Percent	Comments
			Date	Inches					
E0-S18-6 A-E	E0 Drift-S18	3-1	06/11/07	13.507	31.063	1.51	1.36	11%	
E0-S18-4 B-D	E0 Drift-S18	3-1	06/11/07	14.645	31.703	1.64	1.50	9%	
E0-S18-4 H-F	E0 Drift-S18	3-1	06/11/07	9.219	20.075	1.03	0.95	8%	
E0-S30-5 A-C	E0 Drift-S30	3-2	06/11/07	14.092	45.699	1.55	1.46	6%	
E0-S65-3 A-C	E0 Drift-S65	3-3	06/11/07	10.365	40.716	1.15	1.02	13%	

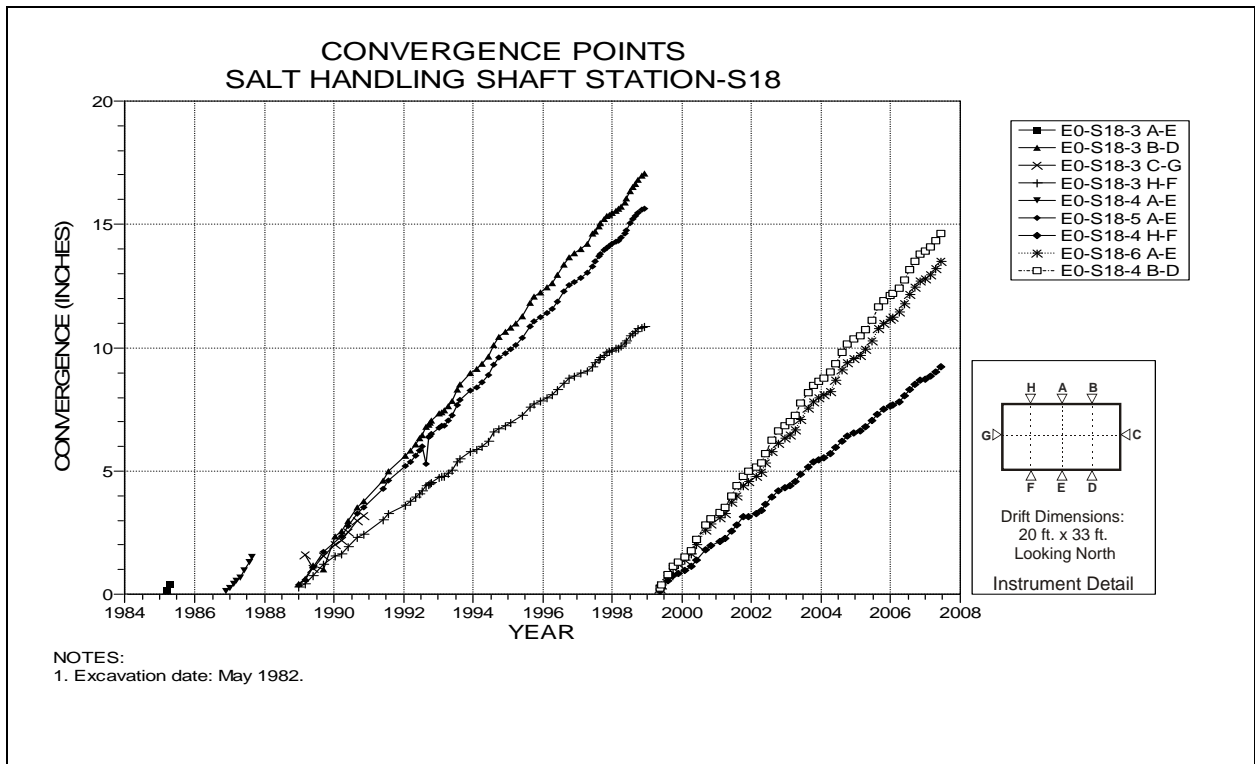


Figure 3-1 Convergence Point Array  
Salt Handling Shaft Station at South 18 – All Chords

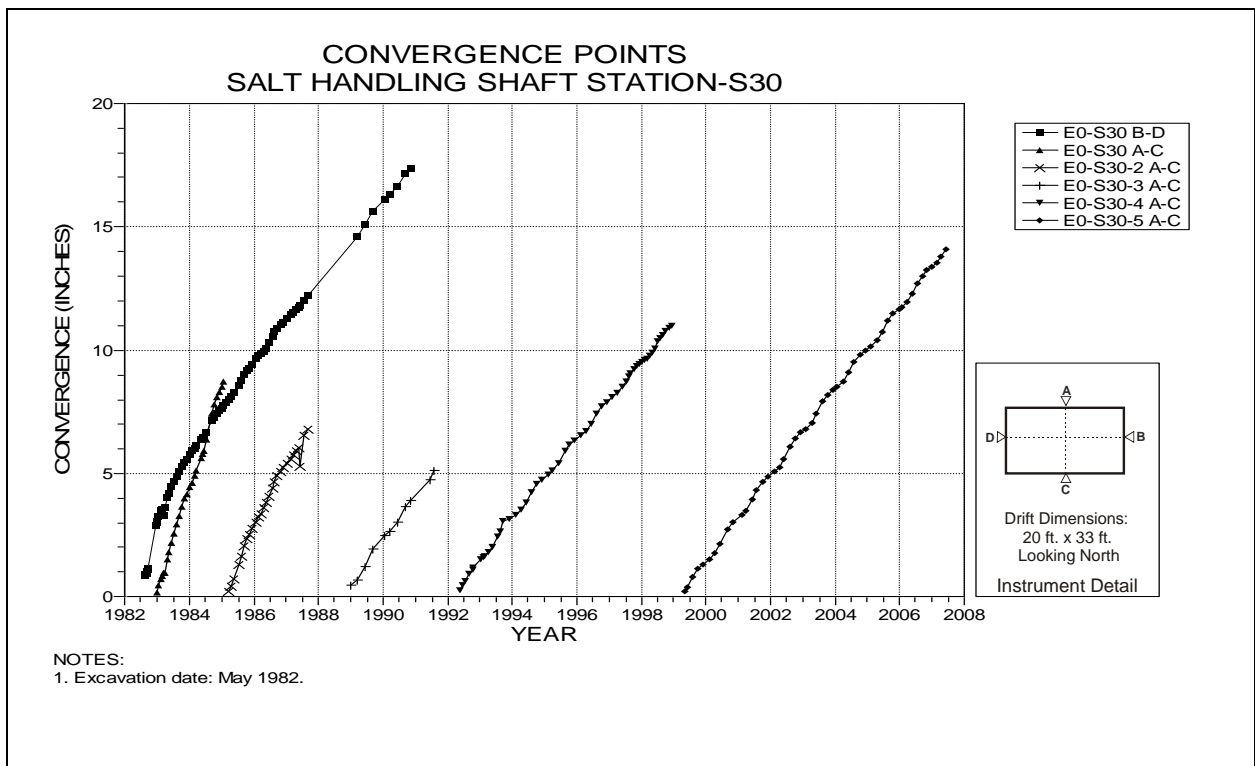


Figure 3-2 Convergence Point Array  
Salt Handling Shaft Station at South 30 – All Chords

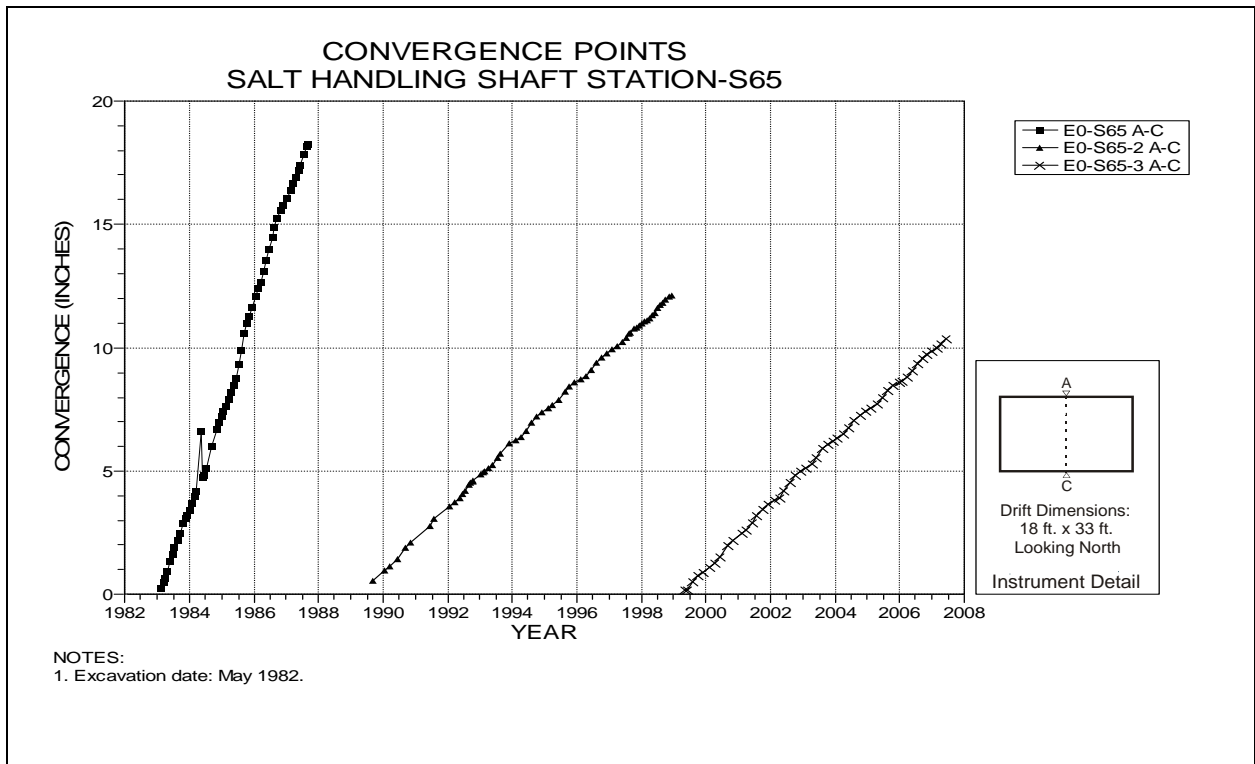


Figure 3-3 Convergence Point Array  
Salt Handling Shaft Station at South 65 – Roof to Floor

**Table 3-2  
Waste Shaft Station Data Analysis**

**EXTENSOMETERS**

Fieldtag	Location	Figure Number	Date of Last Reading	Collar Displacement Relative to Deepest Anchor (inches)	Displacement Rate 2006 to 2007 (in/year)	Displacement Rate 2005 to 2006 (in/year)	Rate Change Percent	Comments	
51X-GE-00268	W30 Drift-S400	Roof	3-4	06/11/07	9.383	0.25	0.28	-11%	
51X-GE-00356	Waste Shaft Brow	North	3-5	06/25/07	0.233	0.08	0.08	0%	
51X-GE-00357	Waste Shaft Brow	South	3-6	05/07/07	0.509	0.20	0.20	0%	

**CONVERGENCE POINTS**

Field Tag	Location	Figure Number	Last Reading 2006-2007		Cumulative Displacement (inches)	Closure Rate 2006 to 2007 (in/year)	Closure Rate 2005 to 2006 (in/year)	Rate Change Percent	Comments
			Date	Inches					
S400-E30-2 C-H	S400 Drift-E30	3-7	05/29/07	19.165	19.238	0.91	0.82	11%	
S400-E90-2 C-G	S400 Drift-E90	3-8	05/29/07	21.789	21.98	1.05	0.95	11%	

**ROCKBOLT LOAD CELLS**

Field Tag	Location	Figure Number	Date of Initial Reading	Date of Last Reading	Load (kips)	Comments
51X WG-00226	Waste Shaft Station Brow	3-9	7/15/1992	06/25/07	42.82	
51X WG-00227	Waste Shaft Station Brow	3-9	7/15/1992	06/25/07	10.44	
51X WG-00228	Waste Shaft Station Brow	3-9	3/20/1996	06/25/07	40.54	
51X WG-00229	Waste Shaft Station Brow	3-9	3/20/1996	06/25/07	36.09	
51X WG-00230	Waste Shaft Station Brow	3-9	3/20/1996	06/25/07	1.92	
51X WG-00231	Waste Shaft Station Brow	3-10	3/20/1996	06/25/07	1.13	
51X WG-00232	Waste Shaft Station Brow	3-10	7/15/1992	06/25/07	0.17	Broken bolt.
51X WG-00233	Waste Shaft Station Brow	3-10	7/15/1992	06/25/07	7.17	
51X WG-00234	Waste Shaft Station Brow	3-10	7/15/1992	06/25/07	69.99	
51X WG-00235	Waste Shaft Station Brow	3-10	3/20/1996	06/25/07	46.77	
51X-WG-00287	S400-E40 Roof	3-11	6/28/2004	06/25/07	40.21	
51X-WG-00288	S400-E80 Roof	3-12	6/28/2004	06/25/07	44.18	

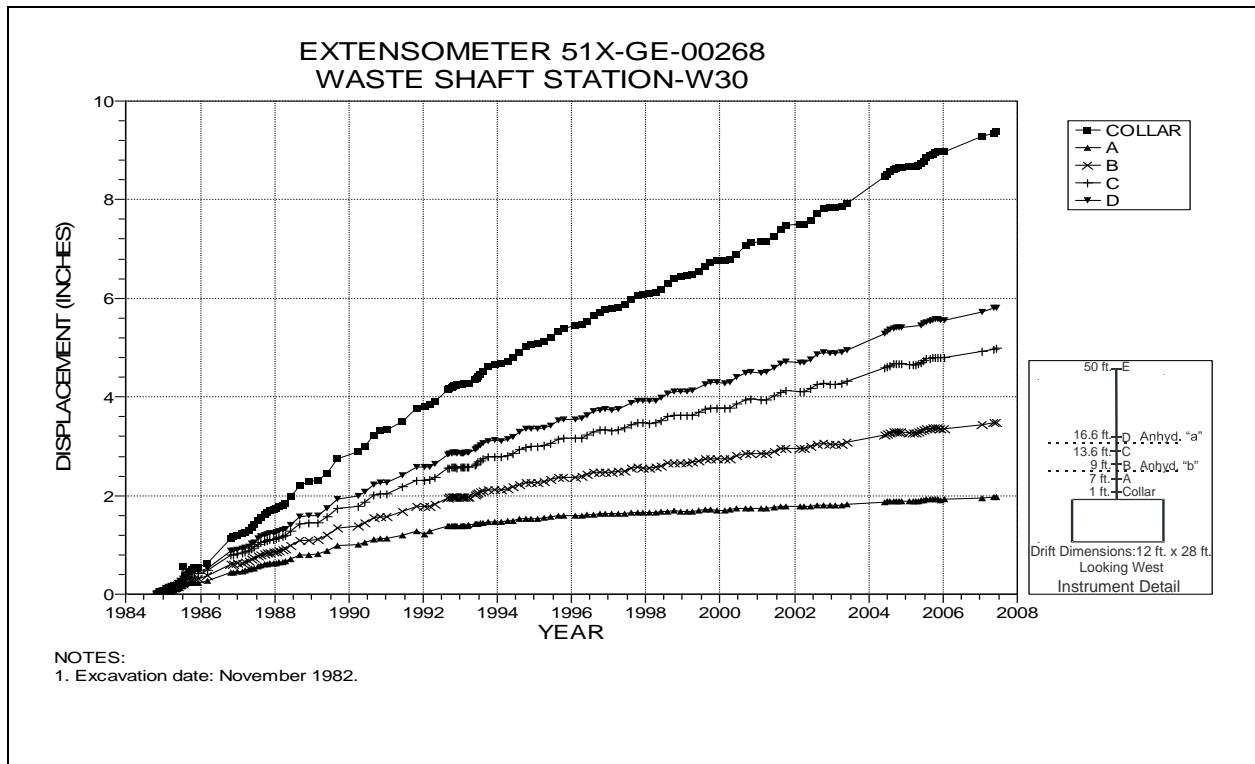


Figure 3-4 Extensometer 51X-GE-00268  
Waste Shaft Station at West 30 – Roof

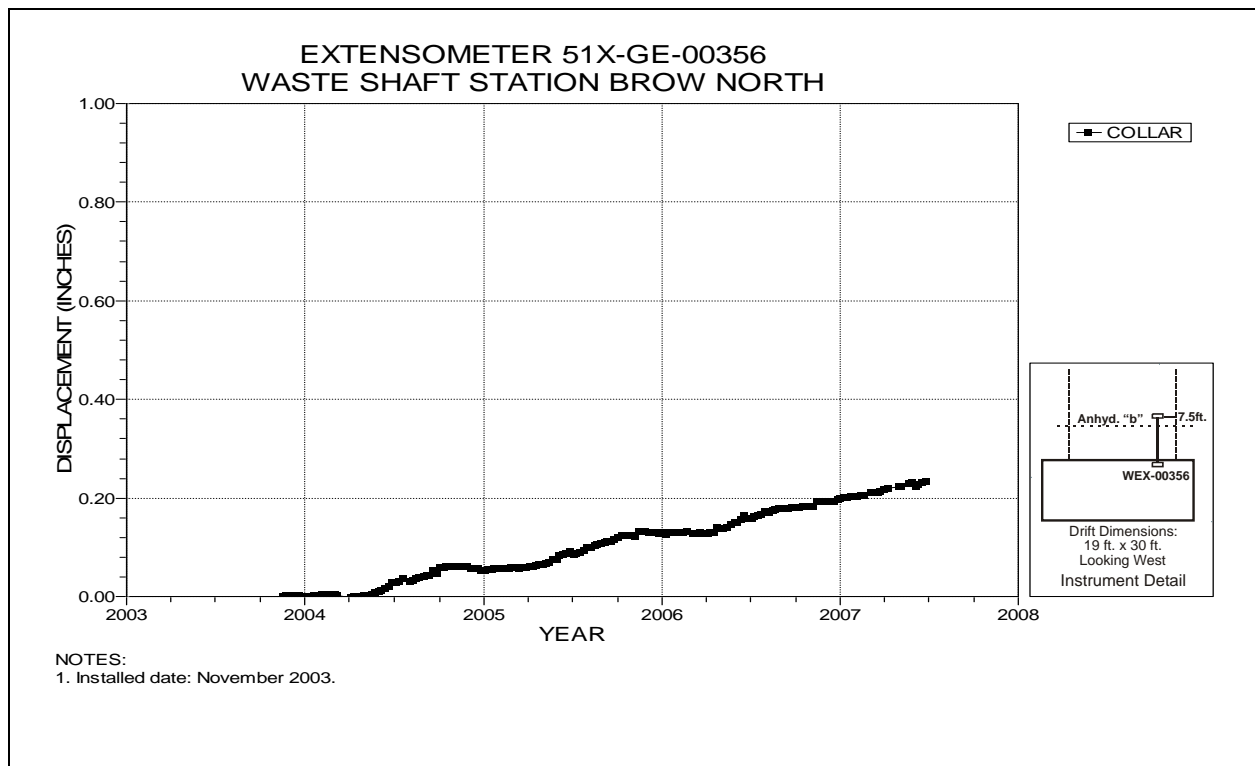


Figure 3-5 Extensometer 51X-GE-00356  
Waste Shaft Station Brow – North

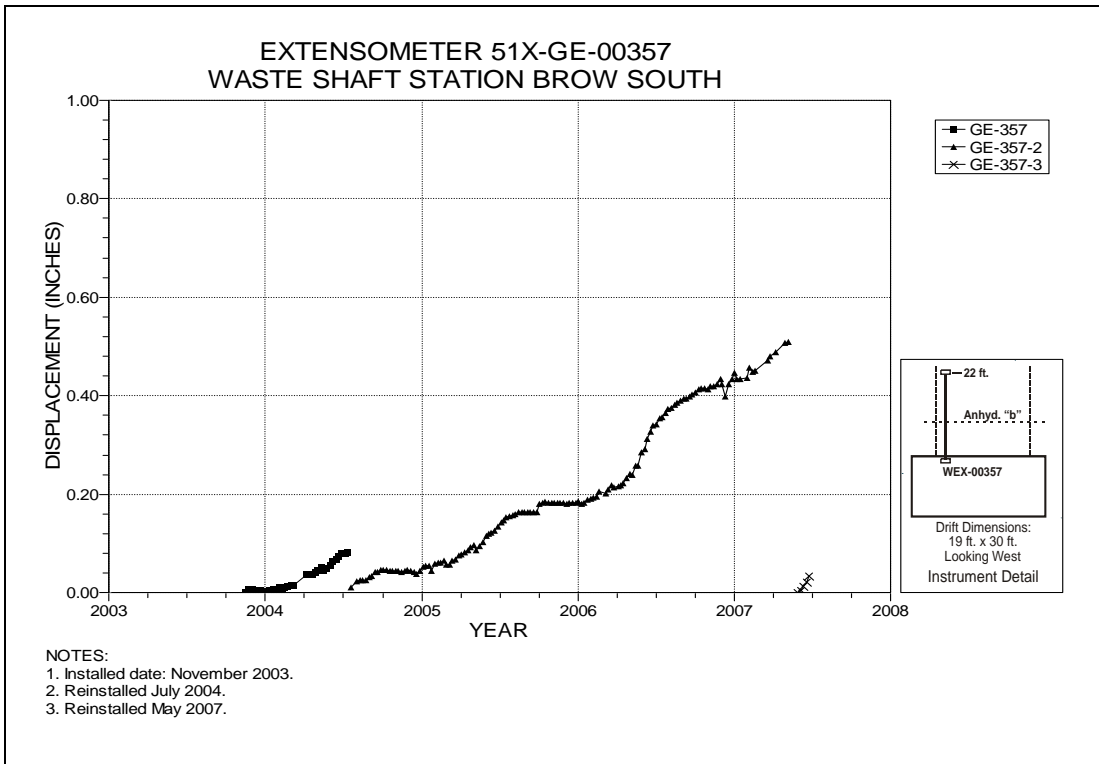


Figure 3-6 Extensometer 51X-GE-00357  
Waste Shaft Station Brow – South

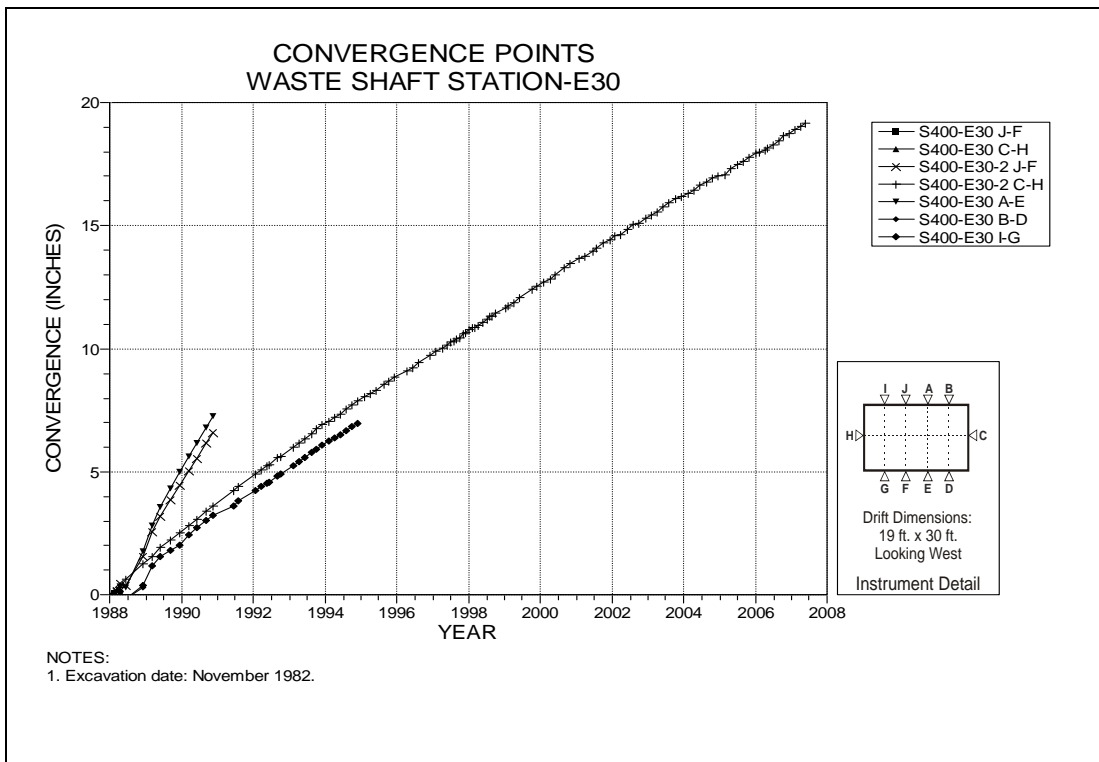


Figure 3-7 Convergence Point Array  
Waste Shaft Station at East 30 – All Chords



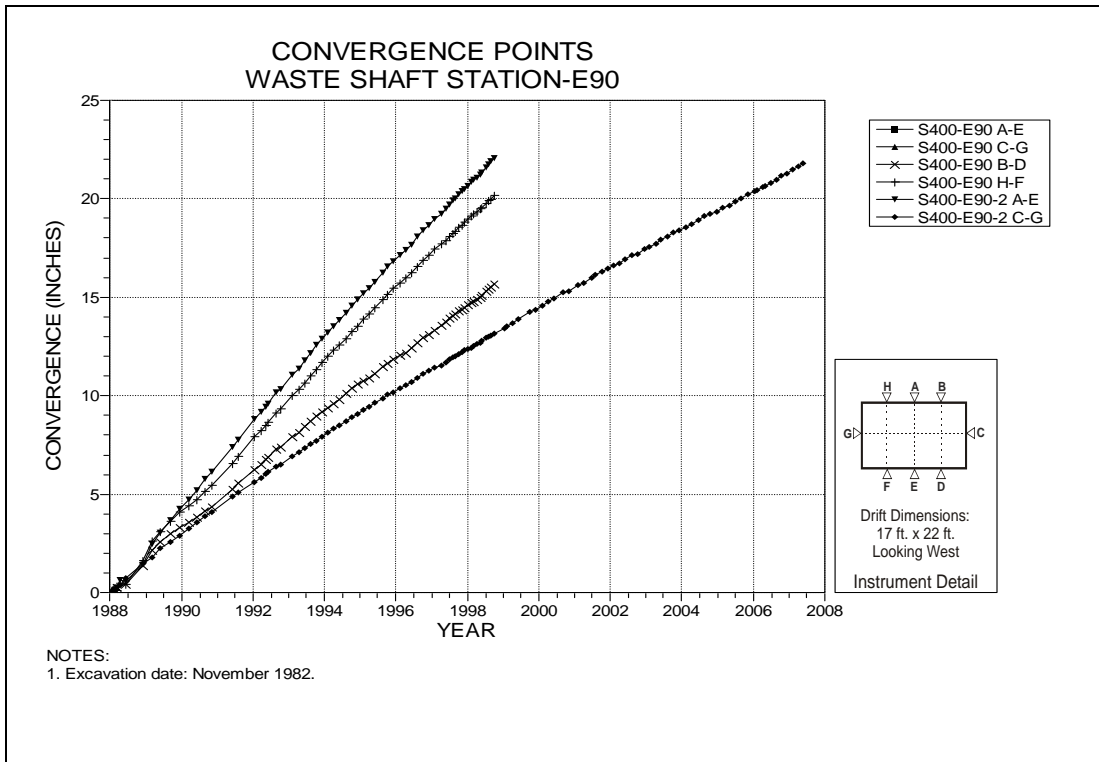


Figure 3-8 Convergence Point Array  
Waste Shaft Station at East 90 – All Chords

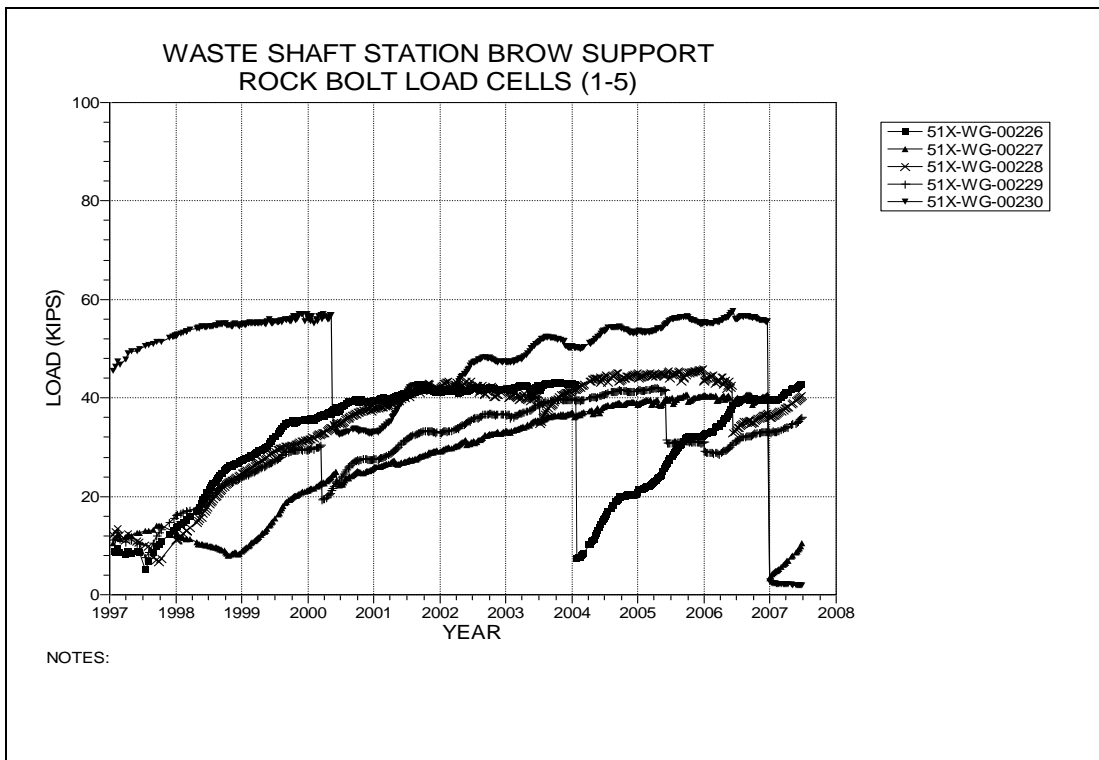


Figure 3-9 Rock Bolt Load Cells  
Waste Shaft Station Brow – Roof Bolts Set 1

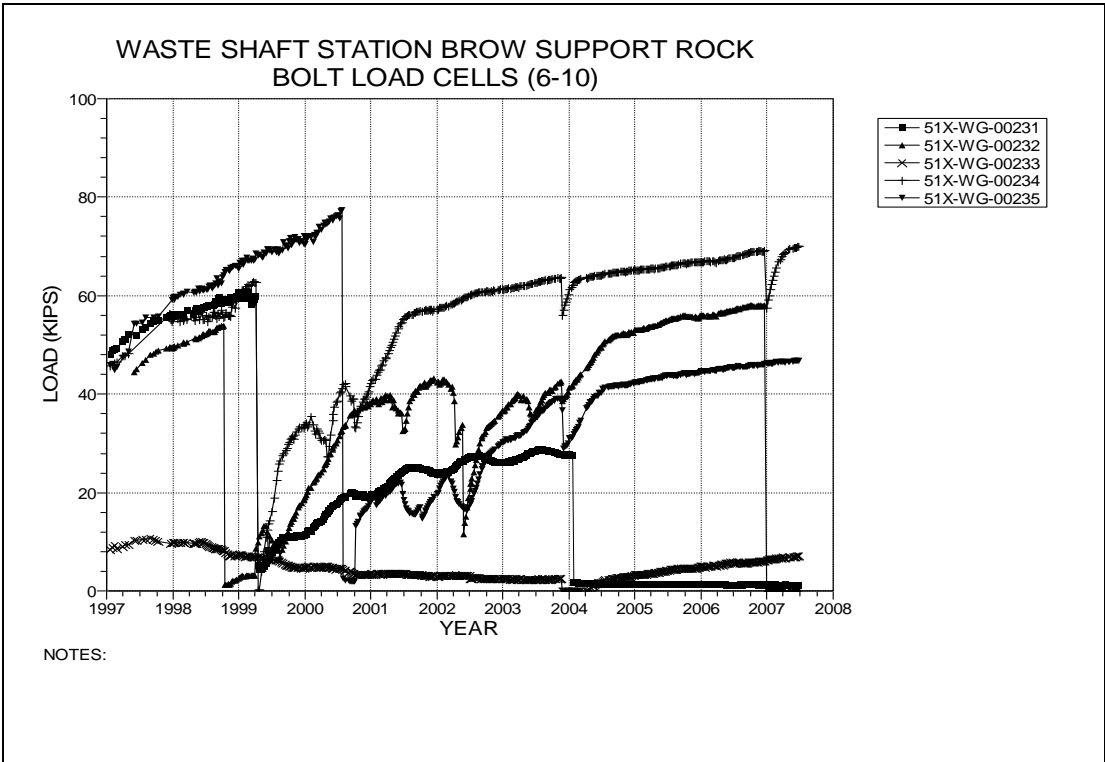


Figure 3-10 Rock Bolt Load Cells  
Waste Shaft Station Brow – Roof Bolts Set 2

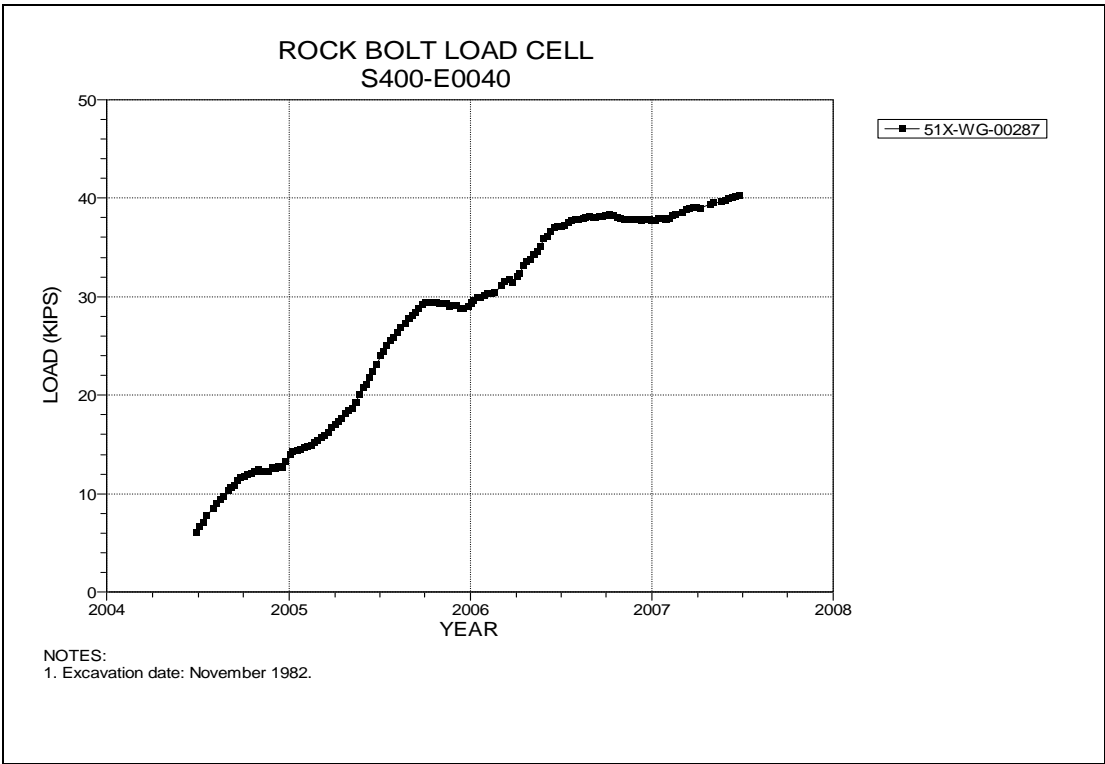


Figure 3-11 Rock Bolt Load Cell  
Waste Shaft Station at East 40 – Roof

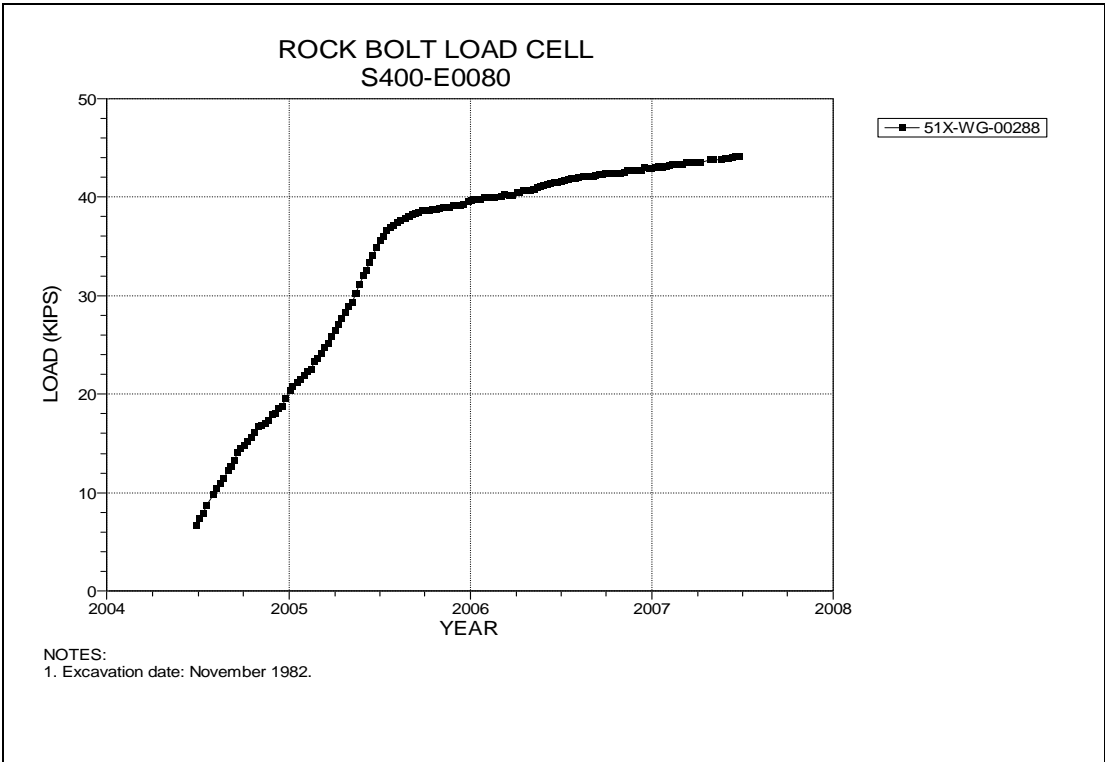


Figure 3-12 Rock Bolt Load Cell  
Waste Shaft Station at East 80 – Roof

**Table 3-3  
Air Intake Shaft Station Data Analysis**

**EXTENSOMETERS**

Field Tag	Location	Figure Number	Date of Last Reading	Collar Displacement Relative to Deepest Anchor (Inches)	Displacement Rate 2006 to 2007 in/year	Displacement Rate 2005 to 2006 in/year	Rate Change Percent	Comments
41X-GE-00122	S65-W620 Roof	3-13	6/25/07	2.816	0.25	0.28	-11%	Calc on anchor "C".
41X-GE-00123	N93-W620 Roof	3-14	6/25/07	3.906	0.34	0.38	-11%	

**ROCKBOLT LOAD CELLS**

Field Tag	Location	Figure Number	Date of Initial Reading	Date of Last Reading	Load (kips)	Comments
51X-WG-00236	AIS Station Brow – South	3-15	01/19/93	06/25/07	38.706	
51X-WG-00237	AIS Station Brow – South	3-15	01/19/93	06/25/07	58.23	
51X-WG-00238	AIS Station Brow – South	3-15	01/19/93	06/25/07	4.332	
51X-WG-00239	AIS Station Brow – South	3-15	01/19/93	06/25/07	17.925	
51X-WG-00240	AIS Station Brow – South	3-15	01/19/93	06/25/07	10.187	
51X-WG-00241	AIS Station Brow – South	3-16	01/19/93	06/25/07	58.709	
51X-WG-00242	AIS Station Brow – South	3-16	01/19/93	06/25/07	1.233	
51X-WG-00243	AIS Station Brow – South	3-16	01/19/93	06/25/07	3.604	
51X-WG-00244	AIS Station Brow – South	3-16	12/24/94	06/25/07	19.059	
51X-WG-00245	AIS Station Brow – South	3-16	01/19/93	06/25/07	56.592	
51X-WG-00246	AIS Station Brow – North	3-17	01/19/93	06/25/07	46.779	
51X-WG-00247	AIS Station Brow – North	3-17	01/19/93	06/25/07	50.925	
51X-WG-00248	AIS Station Brow – North	3-17	01/19/93	06/25/07	3.052	
51X-WG-00249	AIS Station Brow – North	3-17	01/19/93	06/25/07	17.331	

**Table 3-3 (Continued)**  
**Air Intake Shaft Station Data Analysis**

**ROCKBOLT LOAD CELLS (Continued)**

Field Tag	Location	Figure Number	Date of Initial Reading	Date of Last Reading	Load (kips)	Comments
51X-WG-00250	AIS Station Brow – North	3-17	12/24/94	06/25/07	19.555	
51X-WG-00251	AIS Station Brow – North	3-18	01/19/93	06/25/07	42.978	
51X-WG-00252	AIS Station Brow – North	3-18	01/19/93	06/25/07	2.224	
51X-WG-00253	AIS Station Brow – North	3-18	01/19/93	06/25/07	58.673	
51X-WG-00254	AIS Station Brow – North	3-18	01/19/93	06/25/07	16.958	
51X-WG-00255	AIS Station Brow – North	3-18	01/19/93	06/25/07	12.134	

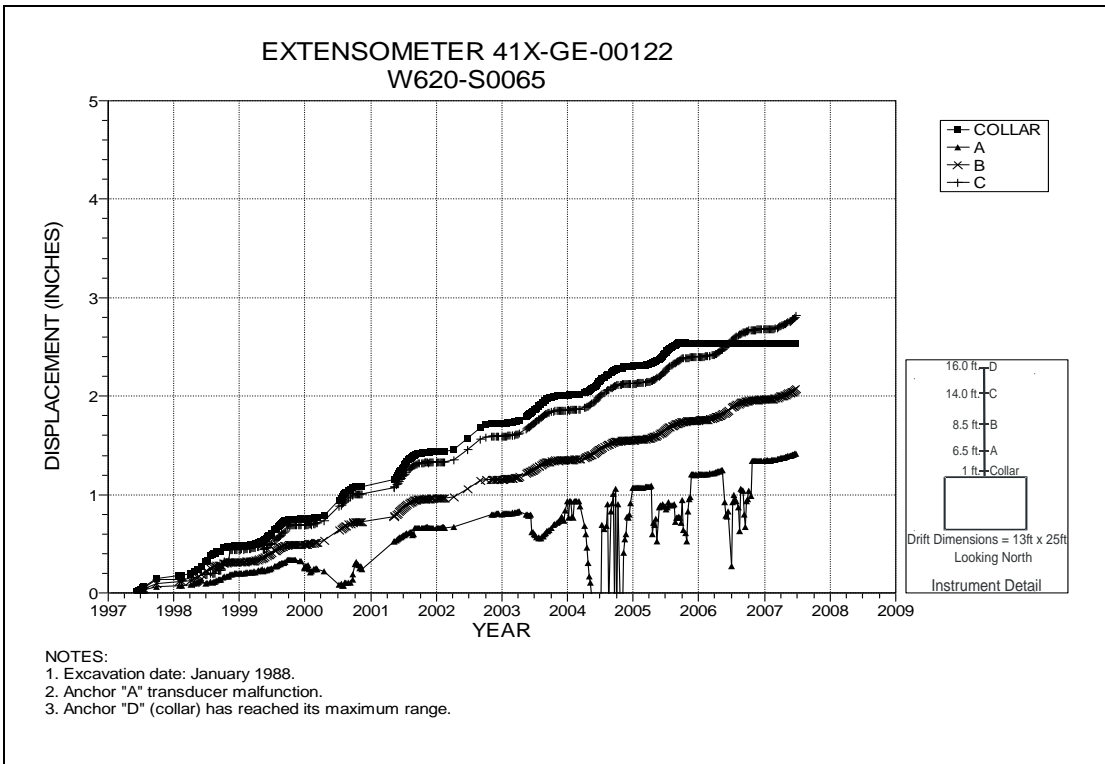


Figure 3-13 Extensometer 41X-GE-00122  
Air Intake Shaft Station at South 65 – Roof

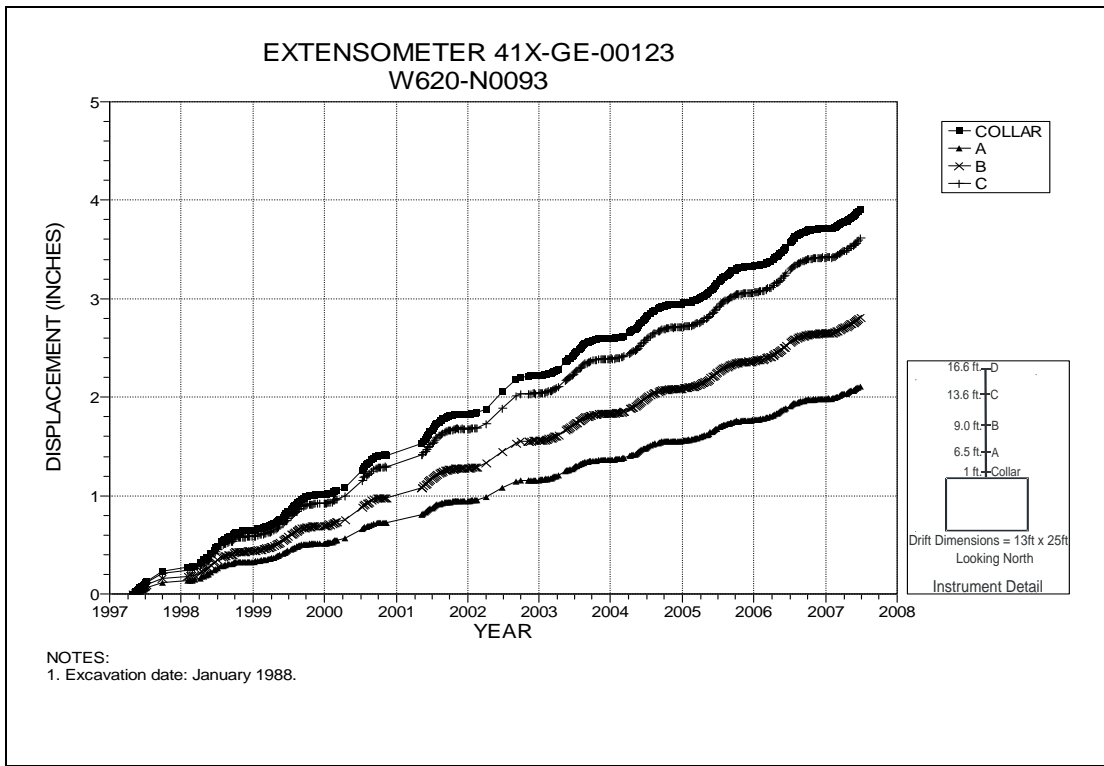


Figure 3-14 Extensometer 41X-GE-00123  
Air Intake Shaft Station at North 93 – Roof

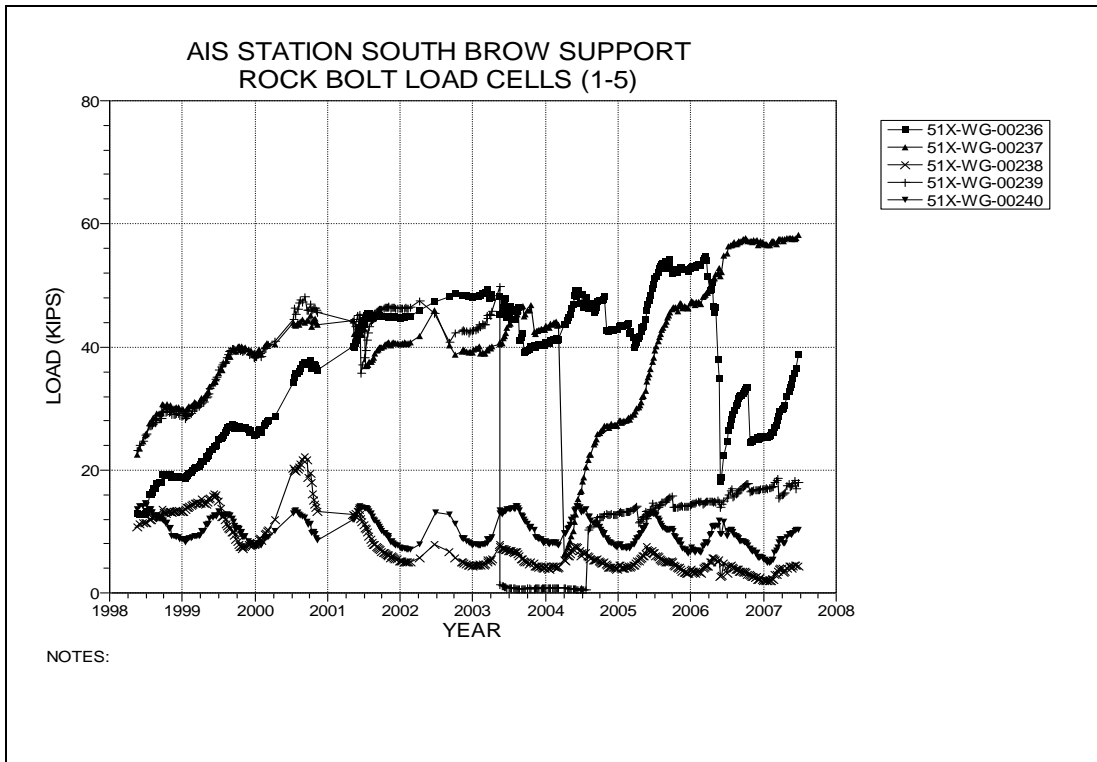


Figure 3-15 Rock Bolt Load Cells  
Air Intake Shaft Station Brow – South Side Roof Bolts Set 1

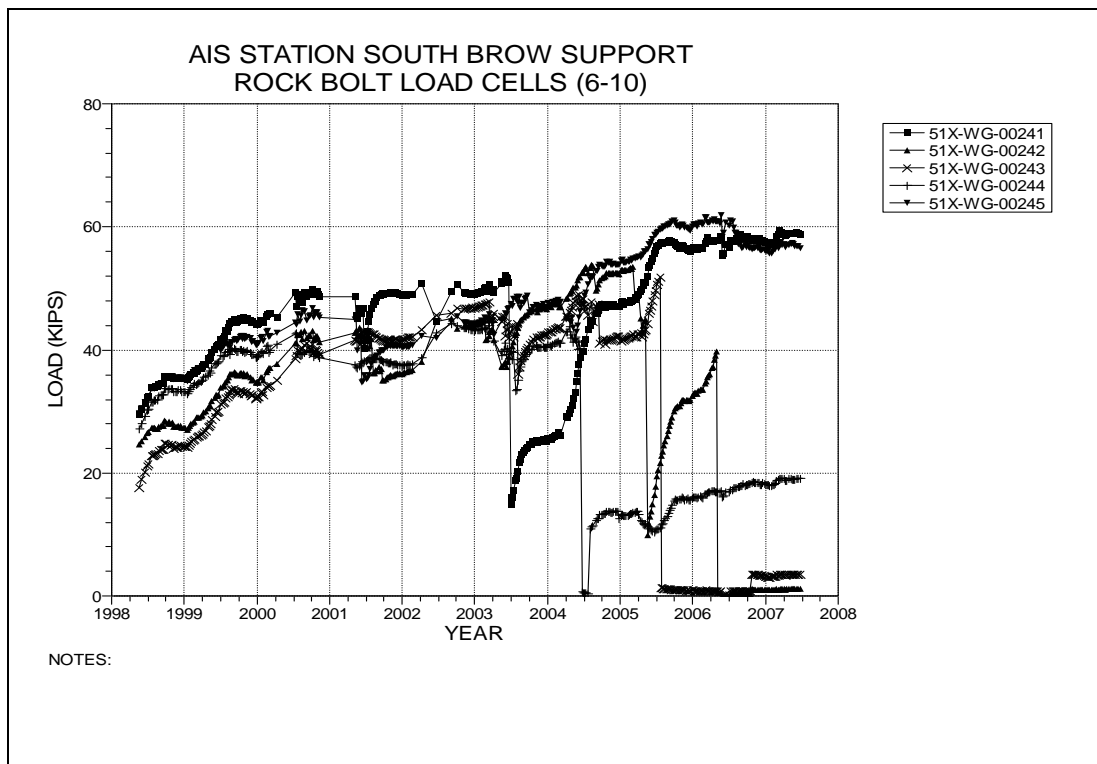
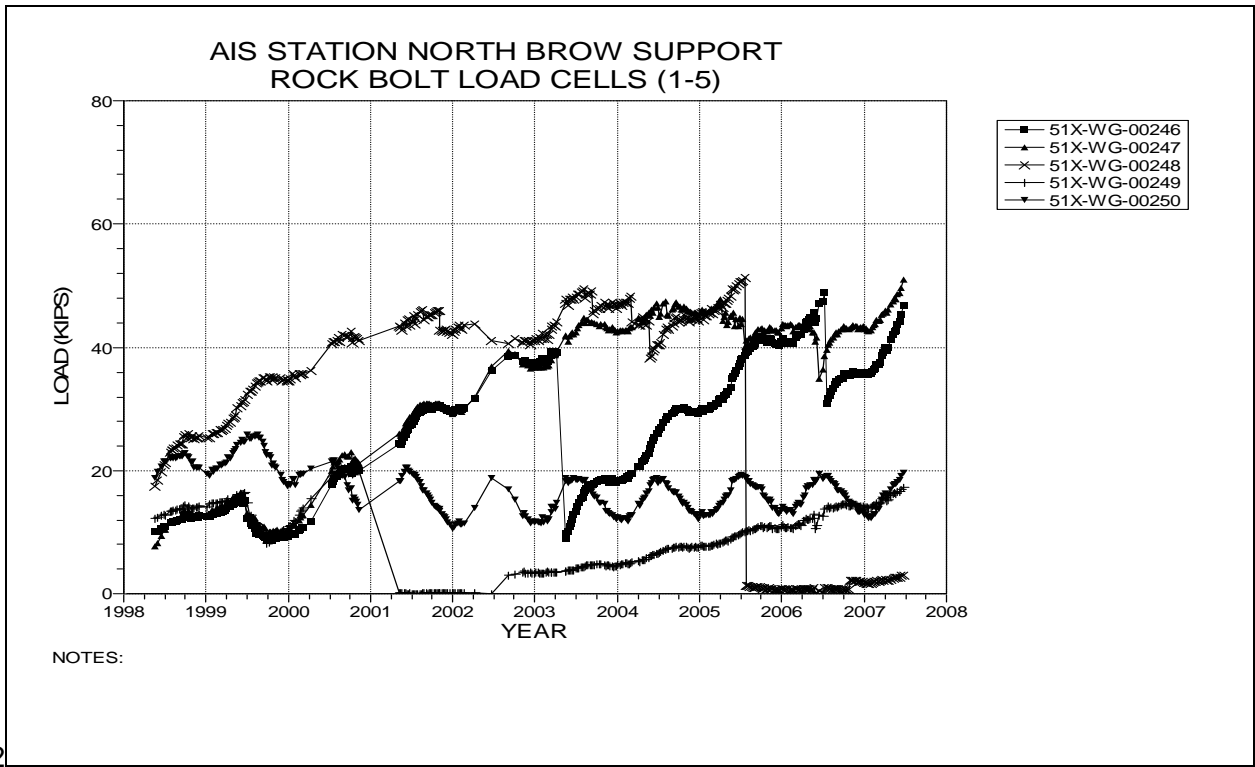


Figure 3-16 Rock Bolt Load Cells  
Air Intake Shaft Station Brow – South Side Roof Bolts Set



2

Figure 3-17 Rock Bolt Load Cells  
Air Intake Shaft Station Brow – North Side Roof Bolts Set 1

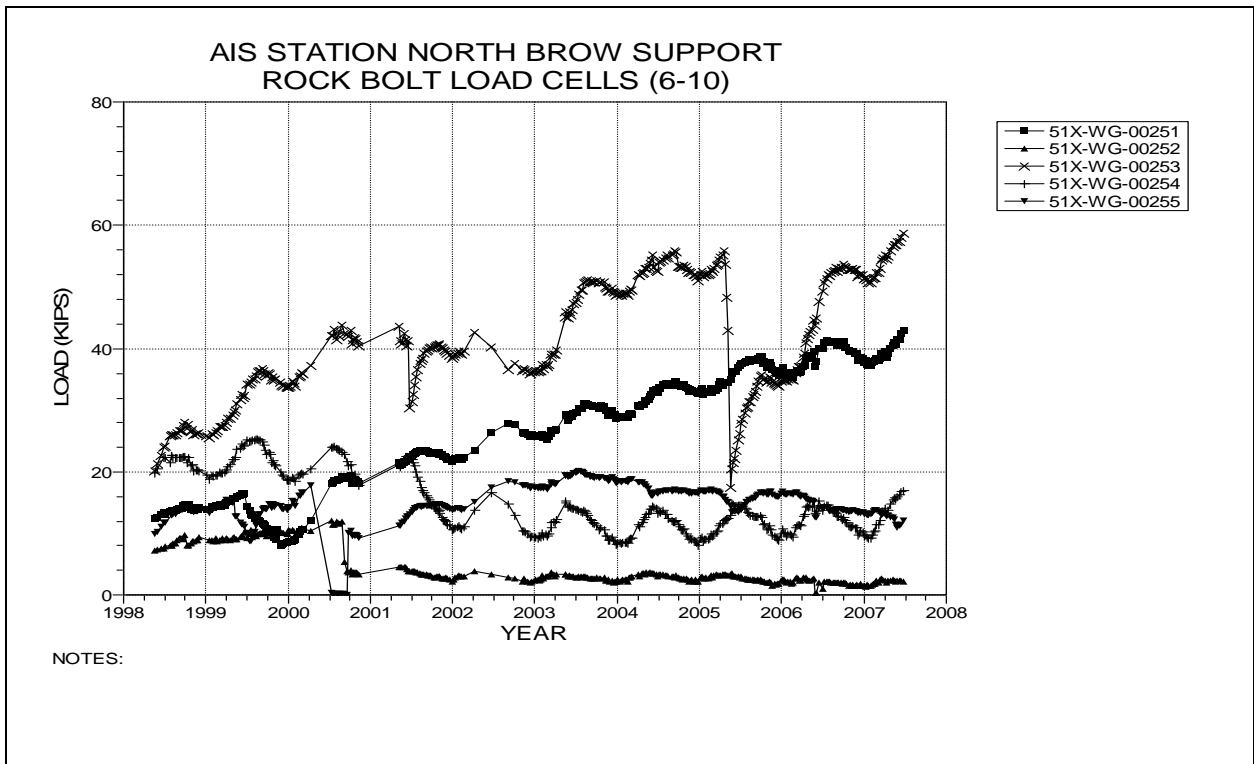


Figure 3-18 Rock Bolt Load Cells  
Air Intake Shaft Station Brow – North Side Roof Bolts Set 2



This page is intentionally blank.

## ***4.0 Instrumentation Summary for the Access Drifts***

---

This chapter presents the instrumentation data and data analyses for the access drifts throughout the WIPP underground. Table 4-1 provides the results of analyses performed on the instrument data including displacement, convergence rates, and rock bolt loading. Figures 4-1 through 4-37 present data from borehole extensometers installed in the access drifts while Figures 4-38 through 4-254 present the convergence point data. Figure 4-255 presents data from joint meters installed at the S1950/E300 overcast. Figure 4-256 through 4-260 presents the data from rock bolt load cells installed in E140 drift and at adjacent brows in S1300 and S1600.

**Table 4-1  
Access Drifts Data Analysis**

**EXTENSOMETERS**

Field Tag	Location	Figure Number	Date of Last Reading	Collar Displacement Relative to Deepest <sup>1</sup> Anchor (inches)	Displacement Rate 2006 to 2007 (in/year)	Displacement Rate 2005 to 2006 <sup>1</sup> (in/year)	Rate Change Percent <sup>1</sup>	Comments
51X-GE-00364	E140 DRIFT-N1266 Roof	4-1	06/25/07	1.989	0.67	0.64	5%	
51X-GE-00365	E140 DRIFT-N940 Roof	4-2	06/25/07	2.490	0.79	0.76	4%	
51X-GE-00373	E300 DRIFT-N1341 Roof	4-3	06/25/07	1.241	0.45	0.49	-8%	
51X-GE-00388	E300 DRIFT-N1266 Roof	4-4	06/25/07	0.307	0.41	N/A	N/A	Not installed in 2005-2006.
51X-GE-00374	E300 DRIFT-N1186 Roof	4-5	06/25/07	2.405	0.94	1.09	-14%	
51X-GE-00105-3	E140 DRIFT-N150 Roof	4-6	06/22/07	2.374	0.77	0.21	267%	
51X-GE-00372	E140 DRIFT-S146 Roof	4-7	06/08/07	1.522	0.74	0.51	45%	
51X-GE-00474	S1000 DRIFT-E120 Roof	4-8	05/24/07	0.997	0.07	0.08	-12%	
51X-GE-00472	E140 DRIFT-S1000 Roof	4-9	05/29/07	4.269	0.21	0.35	-40%	
51X-GE-00473	S1000 DRIFT-E160 Roof	4-10	05/24/07	0.820	0.05	0.07	-29%	
51X-GE-00464	E140 DRIFT-S1025 Roof	4-11	05/29/07	3.700	0.05	0.04	25%	
51X-GE-00333	E140 DRIFT-S1075 Roof	4-12	06/25/07	4.273	0.45	0.53	-15%	
41X-GE-00103	E140 DRIFT-S1150 Roof	4-13	06/25/07	6.935	1.07	1.06	1%	
51X-GE-00461	E140 DRIFT-S1225 Roof	4-14	05/31/07	3.313	0.36	0.43	-16%	
51X-GE-00334	E140 DRIFT-S1225 Roof	4-15	06/25/07	4.860	0.59	0.63	-6%	
51X-GE-00462	S1300 DRIFT-E120 Roof	4-16	05/24/07	0.537	0.03	0.06	-50%	
51X-GE-00465	E140 DRIFT-S1300 Roof	4-17	05/31/07	1.978	0.10	0.19	-47%	
51X-GE-00335	E140 DRIFT-S1300 Roof	4-18	06/25/07	3.175	0.28	0.36	-22%	
51X-GE-00463	S1300 DRIFT-E160 Roof	4-19	05/24/07	3.093	0.25	0.35	-29%	
51X-GE-00442	S1600 DRIFT-E120 Roof	4-20	05/25/07	0.788	0.03	0.07	-57%	
51X-GE-00441	S1600-E160 BROW Roof	4-21	05/24/07	2.075	0.18	0.16	12%	
51X-GE-00492	E140 DRIFT-S2750 Roof	4-22	06/25/07	2.086	0.22	0.47	-53%	
51X-GE-00367	E140 DRIFT-S2916 Roof	4-23	06/18/07	5.642	1.81 <sup>2</sup>	1.52 <sup>2</sup>	19%	Calculations on anchor "B".
51X-GE-00361	E0 DRIFT-N1266 Roof	4-24	06/25/07	4.118	1.11	1.24	-10%	
51X-GE-00352	E0 DRIFT-N940 Roof	4-25	06/25/07	1.924	0.39	0.46	-15%	

<sup>1</sup> NA indicates insufficient data to compare annualized rates.

<sup>2</sup> If the deepest anchor has malfunctioned, the next deepest available anchor is used in the calculations. This will be indicated in the 'Comments' field

**Table 4-1 (Continued)  
Access Drifts Data Analysis**

**EXTENSOMETERS (Continued)**

Field Tag	Location	Figure Number	Date of Last Reading	Collar Displacement Relative to Deepest <sup>1</sup> Anchor (inches)	Displacement Rate 2006 to 2007 (in/year)	Displacement Rate 2005 to 2006 (in/year)	Rate Change Percent	Comments	
51X-GE-00353	E0 DRIFT-N626	Roof	4-26	06/25/07	2.054	0.43	0.48	-10%	
51X-GE-00355	E0 DRIFT-N300	Roof	4-27	06/25/07	2.659	0.32	0.42	-24%	
51X-GE-00481	N300 DRIFT-W10	Roof	4-28	06/21/07	2.017	0.17	0.36	-53%	
41X-GE-00127	W110-N300	Roof	4-29	03/12/07	4.022	0.36 <sup>2</sup>	0.33 <sup>2</sup>	9%	Calculations on anchor "A".
41X-GE-00126	W212-N300	Roof	4-30	06/25/07	7.972	0.58	0.73	-21%	
41X-GE-00125	W417-N248	Roof	4-31	06/25/07	4.839	0.44	0.50	-12%	
41X-GE-00124	W519-N190	Roof	4-32	06/25/07	4.757	0.43	0.51	-16%	
51X-GE-00494	E300 DRIFT-S2892	Roof	4-33	06/08/07	3.616	1.13	0.97	16%	
51X-GE-00490	W30 DRIFT-S2750	Roof	4-34	06/12/07	1.191	0.26	0.25	4%	
51X-GE-00491	W30 DRIFT-S2916	Roof	4-35	04/16/07	4.229	1.52	1.05	45%	
51X-GE-00489	W30 DRIFT-S3080	Roof	4-36	06/12/07	4.380	1.03 <sup>2</sup>	0.75 <sup>2</sup>	37%	Calculations on anchor "A".
51X-GE-00495	W170 DRIFT-S2634	Roof	4-37	05/14/07	4.611	1.59	1.30	22%	

<sup>2</sup> If the deepest anchor has malfunctioned, the next deepest available anchor is used in the calculations. This will be indicated in the 'Comments' field

**Table 4-1 (Continued)  
Access Drifts Data Analysis**

**CONVERGENCE POINTS**

Field Tag	Location	Figure Number	Last Reading 2006 to 2007		Cumulative Displacement (inches)	Closure Rate 2006 to 2007 (in/year)	Closure Rate 2005 to 2006 (in/year)	Rate Change Percent	Comments
			Date	Inches					
E300-N1341-2 A-C	E300 DRIFT-N1341	4-38	02/26/07	4.489	4.489	2.20	2.16	2%	
E300-N1262-2 A-C	E300 DRIFT-N1262	4-39	02/26/07	4.437	4.437	2.11	2.06	2%	
E300-N1186-2 A-C	E300 DRIFT-N1186	4-40	02/26/07	4.866	4.866	2.34	2.48	-6%	
E300-N250-3 A-C	E300 DRIFT-N250	4-41	06/08/07	0.837	29.840	1.32	1.51	-13%	
E300-N170-2 A-E	E300 DRIFT-N170	4-42	06/08/07	1.084	23.579	1.55	1.38	12%	
E300-N170-2 H-F	E300 DRIFT-N170	4-42	06/08/07	0.977	21.038	1.40	1.26	11%	
E300-N170-2 C-G	E300 DRIFT-N170	4-42	06/08/07	3.464	18.357	1.23	0.98	26%	
E300-N45 A-E	E300 DRIFT-N45	4-43	06/08/07	24.532	24.532	1.54	1.43	8%	
E300-N45 H-F	E300 DRIFT-N45	4-43	06/08/07	21.579	21.579	1.57	1.42	11%	
E300-N45 C-G	E300 DRIFT-N45	4-43	06/08/07	17.661	17.661	1.17	0.98	19%	
E300-S45-2 A-E	E300 DRIFT-S45	4-44	06/08/07	19.495	19.495	1.15	1.04	11%	
E300-S45-2 B-D	E300 DRIFT-S45	4-44	06/08/07	16.093	16.093	1.16	0.95	22%	
E300-S45-2 H-F	E300 DRIFT-S45	4-44	06/08/07	16.938	16.938	1.05	0.94	12%	
E300-S45 C-G	E300 DRIFT-S45	4-44	06/08/07	15.161	15.161	0.90	0.76	18%	
E300-S90 A-C	E300 DRIFT-S90	4-45	06/04/07	14.952	14.952	0.75	0.69	9%	
E300-S250-2 A-C	E300 DRIFT-S250	4-46	06/04/07	5.980	10.390	0.63	0.52	21%	
E300-S250-2 B-D	E300 DRIFT-S250	4-46	06/04/07	6.465	10.538	0.66	0.56	18%	
E300-S700 A-C	E300 DRIFT-S700	4-47	4/9/2007	17.428	17.428	0.62	0.60	3%	
E300-S850 A-E	E300 DRIFT-S850	4-48	4/9/2007	13.385	13.385	0.48	0.43	12%	
E300-S850 B-D	E300 DRIFT-S850	4-48	4/10/2007	9.952	9.952	0.29	0.31	-6%	
E300-S850 H-F	E300 DRIFT-S850	4-48	4/9/2007	9.211	9.211	0.35	0.33	6%	
E300-S850-2 C-G	E300 DRIFT-S850	4-48	4/9/2007	5.655	14.933	0.54	0.55	-2%	
E300-S1000 A-C	E300 DRIFT-S1000	4-49	4/9/2007	17.329	17.329	0.59	0.58	2%	
E300-S1150-3 A-E	E300 DRIFT-S1150	4-50	4/9/2007	9.525	15.015	0.60	0.53	13%	
E300-S1150-3 B-D	E300 DRIFT-S1150	4-50	4/9/2007	6.610	10.669	0.42	0.35	20%	

**Table 4-1 (Continued)  
Access Drifts Data Analysis**

**CONVERGENCE POINTS (Continued)**

Field Tag	Location	Figure Number	Last Reading 2006 to 2007		Cumulative Displacement (inches)	Closure Rate 2006 to 2007 (in/year)	Closure Rate 2005 to 2006 (in/year)	Rate Change Percent	Comments
			Date	Inches					
E300-S1150-3 H-F	E300 DRIFT-S1150	4-50	4/9/2007	6.615	10.235	0.43	0.36	19%	
E300-S1150-2 C-G	E300 DRIFT-S1150	4-51	4/9/2007	6.659	17.115	0.63	0.61	3%	
E300-S1300 A-C	E300 DRIFT-S1300	4-52	6/4/2007	11.047	11.047	0.72	0.69	4%	
E300-S1450 A-C	E300 DRIFT-S1450	4-53	06/04/07	6.610	6.610	0.71	0.64	11%	
E300-S1450 B-D	E300 DRIFT-S1450	4-53	06/04/07	7.508	7.508	0.83	0.73	14%	
E300-S1687 A-C	E300 DRIFT-S1687	4-54	06/04/07	6.919	6.919	0.84	0.76	11%	
E300-S1687 B-D	E300 DRIFT-S1687	4-54	06/04/07	7.474	7.474	0.86	0.77	12%	
E300-S1775 A-C	E300 DRIFT-S1775	4-55	06/04/07	6.404	6.404	0.71	0.62	15%	
E300-S1775 B-D	E300 DRIFT-S1775	4-55	06/04/07	7.610	7.610	0.89	0.77	16%	
E300-S1862 A-C	E300 DRIFT-S1862	4-56	06/04/07	6.781	6.781	0.80	0.71	13%	
E300-S1862 B-D	E300 DRIFT-S1862	4-56	06/04/07	8.088	8.088	0.94	0.84	12%	
E300-S2065 A-C	E300 DRIFT-S2065	4-57	06/04/07	7.894	7.894	0.92	0.87	6%	
E300-S2065 B-D	E300 DRIFT-S2065	4-57	06/04/07	10.287	10.287	1.18	1.15	3%	
E300-S2275 A-C	E300 DRIFT-S2275	4-58	06/04/07	9.494	9.494	1.12	1.13	-1%	
E300-S2275 B-D	E300 DRIFT-S2275	4-58	06/04/07	11.917	11.917	1.53	1.49	3%	
E300-S2350 A-C	E300 DRIFT-S2350	4-59	06/04/07	11.097	11.097	1.30	1.28	2%	
E300-S2350 B-D	E300 DRIFT-S2350	4-59	06/04/07	12.519	12.519	1.59	1.54	3%	
E300-S2425 A-C	E300 DRIFT-S2425	4-60	06/04/07	11.279	11.279	1.38	1.32	5%	
E300-S2425 B-D	E300 DRIFT-S2425	4-60	06/04/07	12.720	12.720	1.61	1.54	5%	
E300-S2634 A-C	E300 DRIFT-S2634	4-61	06/04/07	7.523	7.523	1.60	1.54	4%	
E300-S2634 B-D	E300 DRIFT-S2634	4-61	06/04/07	7.746	7.746	1.62	1.56	4%	
E300-S2833 A-C	E300 DRIFT-S2833	4-62	06/04/07	8.599	8.599	1.88	1.84	2%	
E300-S2833 B-D	E300 DRIFT-S2833	4-62	06/04/07	8.223	8.223	1.62	1.69	-4%	
E300-S2916 A-C	E300 DRIFT-S2916	4-63	06/04/07	15.197	15.197	4.04	3.66	10%	
E300-S2916 B-D	E300 DRIFT-S2916	4-63	06/04/07	9.204	9.204	1.93	1.98	-3%	
E300-S2998 A-C	E300 DRIFT-S2998	4-64	06/04/07	24.131	24.131	5.47	6.11	-10%	
E300-S2998 B-D	E300 DRIFT-S2998	4-64	06/04/07	8.801	8.801	1.87	1.89	-1%	

**Table 4-1 (Continued)  
Access Drifts Data Analysis**

**CONVERGENCE POINTS (Continued)**

Field Tag	Location	Figure Number	Last Reading 2006 to 2007		Cumulative Displacement (inches)	Closure Rate 2006 to 2007 (in/year)	Closure Rate 2005 to 2006 <sup>1</sup> (in/year)	Rate Change Percent <sup>1</sup>	Comments
			Date	Inches					
E300-S3195 A-C	E300 DRIFT-S3195	4-65	06/04/07	8.920	8.920	1.91	2.10	-9%	
E300-S3195 B-D	E300 DRIFT-S3195	4-65	06/04/07	9.162	9.162	1.81	2.12	-15%	
E300-S3480 A-C	E300 DRIFT-S3480	4-66	06/06/07	1.465	1.465	1.96	N/A	N/A	Not installed in 2005-2006.
E300-S3480 B-D	E300 DRIFT-S3480	4-66	06/06/07	1.256	1.256	1.68	N/A	N/A	Not installed in 2005-2006.
E140-N1420-2 A-C	E140 DRIFT-N1420	4-67	06/21/07	4.609	21.099	1.56	1.56	0%	
E140-N1266-4 B-D	E140 DRIFT-N1266	4-68	06/19/07	3.734	25.801	1.36	1.36	0%	
E140-N1266-3 A-C	E140 DRIFT-N1266	4-68	06/19/07	7.105	44.882	2.64	2.61	1%	
E140-N1100-2 A-C	E140 DRIFT-N1100	4-69	06/19/07	4.130	4.130	1.45	1.42	2%	
E140-N940-2 A-C	E140 DRIFT-N940	4-70	06/19/07	7.492	7.492	2.78	2.65	5%	
E140-N940-2 B-D	E140 DRIFT-N940	4-70	06/19/07	3.427	3.427	1.35	1.28	5%	
E140-N780-2 A-C	E140 DRIFT-N780	4-71	06/19/07	12.375	44.153	2.57	2.53	2%	
E140-N686-2 A-C	E140 DRIFT-N686	4-72	06/19/07	9.255	23.971	2.22	2.03	9%	
E140-N686-2 B-D	E140 DRIFT-N686	4-72	06/19/07	6.618	6.618	1.52	1.45	5%	
E140-N626-3 A-C	E140 DRIFT-N626	4-73	06/19/07	11.485	44.079	2.73	2.55	7%	
E140-N626-4 B-D	E140 DRIFT-N626	4-73	06/19/07	6.569	27.929	1.50	1.46	3%	
E140-N562-2 A-C	E140 DRIFT-N562	4-74	06/19/07	8.787	20.628	2.08	1.92	8%	
E140-N562-2 B-D	E140 DRIFT-N562	4-74	06/19/07	6.660	14.962	1.52	1.47	3%	
E140-N460-3 A-C	E140 DRIFT-N460	4-75	06/19/07	10.655	31.551	1.75	1.58	11%	
E140-N355-2 A-C	E140 DRIFT-N355	4-76	06/19/07	1.207	9.753	1.60	1.50	7%	
E140-N355 B-D	E140 DRIFT-N355	4-76	06/19/07	9.000	9.000	1.55	1.36	14%	
E140-N220-3 A-C	E140 DRIFT-N220	4-77	06/19/07	1.724	27.548	2.29	1.41	62%	
E140-N150-4 A-C	E140 DRIFT-N150	4-78	06/19/07	1.968	21.068	2.56	1.05	144%	
E140-N5-6 A-C	E140 DRIFT-N5	4-79	06/19/07	1.789	33.677	2.34	1.24	89%	
E140-N5-3 B-D	E140 DRIFT-N5	4-79	06/19/07	11.360	26.601	1.33	0.96	39%	
E140-S90-4 A-C	E140 DRIFT-S90	4-80	05/31/07	1.136	18.871	1.58	1.13	40%	

<sup>1</sup>NA indicates insufficient data to compare annualized rates.

**Table 4-1 (Continued)  
Access Drifts Data Analysis**

**CONVERGENCE POINTS (Continued)**

Field Tag	Location	Figure Number	Last Reading 2006 to 2007		Cumulative Displacement (inches)	Closure Rate 2006 to 2007 (in/year)	Closure Rate 2005 to 2006 (in/year)	Rate Change Percent	Comments
			Date	Inches					
E140-S262-4 A-C	E140 DRIFT-S262	4-81	05/31/07	4.800	25.733	2.12	1.96	8%	
E140-S262-3 B-D	E140 DRIFT-S262	4-81	05/31/07	15.182	16.535	1.17	1.10	6%	
E140-S460-2 B-D	E140 DRIFT-S460	4-82	05/29/07	21.344	27.288	1.06	0.94	13%	
E140-S460-5 A-C	E140 DRIFT-S460	4-82	05/29/07	0.763	44.064	2.07	1.75	18%	
E140-S550-5 A-C	E140 DRIFT-S550	4-83	05/29/07	0.618	36.429	1.71	1.30	32%	
E140-S550-4 B-D	E140 DRIFT-S550	4-83	05/29/07	22.486	31.128	1.21	1.10	10%	
E140-S700-6 A-D	E140 DRIFT-S700	4-84	05/29/07	3.564	25.192	1.41	1.50	-6%	
E140-S700-5 B-C	E140 DRIFT-S700	4-85	05/29/07	4.013	25.362	1.61	1.63	-1%	
E140-S700-5 E-F	E140 DRIFT-S700	4-85	05/29/07	2.289	19.997	0.95	1.00	-5%	
E140-S850-8 A-C	E140 DRIFT-S850	4-86	05/29/07	5.595	44.730	2.33	2.25	4%	
E140-S850-4 B-D	E140 DRIFT-S850	4-87	05/29/07	13.438	29.385	1.23	1.12	10%	
E140-S1000-2 A-C	E140 DRIFT-S1000	4-88	05/29/07	3.805	30.754	1.26	1.69	-25%	
E140-S1025-3 A-C	E140 DRIFT-S1025	4-89	06/25/07	4.319	17.189	1.63	1.76	-7%	
E140-S1075-3 A-E	E140 DRIFT-S1075	4-90	06/25/07	4.388	15.075	1.75	1.78	-2%	
E140-S1075-3 B-D	E140 DRIFT-S1075	4-90	06/25/07	3.512	13.873	1.09	1.59	-31%	
E140-S1075-3 F-H	E140 DRIFT-S1075	4-90	06/25/07	2.787	11.621	1.23	1.06	16%	
E140-S1075-2 C-G	E140 DRIFT-S1075	4-90	06/25/07	11.505	11.505	1.17	1.18	-1%	
E140-S1150-3 A-G	E140 DRIFT-S1150	4-91	06/25/07	5.927	47.693	2.45	2.34	5%	
E140-S1150-3 B-F	E140 DRIFT-S1150	4-91	06/25/07	5.313	19.354	2.18	2.12	3%	
E140-S1150-4 L-H	E140 DRIFT-S1150	4-91	06/25/07	3.778	14.569	1.55	1.60	-3%	
E140-S1150 C-K	E140 DRIFT-S1150	4-92	06/25/07	12.200	12.200	1.17	1.10	6%	
E140-S1150-2 D-J	E140 DRIFT-S1150	4-92	06/25/07	12.355	32.226	1.25	1.27	-2%	
E140-S1150-2 E-I	E140 DRIFT-S1150	4-92	06/25/07	11.265	12.175	1.18	1.11	6%	
E140-S1225-3 A-E	E140 DRIFT-S1225	4-93	06/25/07	5.057	19.593	2.06	2.03	1%	
E140-S1225-2 B-D	E140 DRIFT-S1225	4-93	06/25/07	18.230	20.340	2.04	2.03	0%	



**Table 4-1 (Continued)  
Access Drifts Data Analysis**

**CONVERGENCE POINTS (Continued)**

Field Tag	Location	Figure Number	Last Reading 2006 to 2007		Cumulative Displacement (inches)	Closure Rate 2006 to 2007 (in/year)	Closure Rate 2005 to 2006 (in/year)	Rate Change Percent	Comments
			Date	Inches					
E140-S1225-2 H-F	E140 DRIFT-S1225	4-93	06/25/07	13.022	14.621	1.47	1.43	3%	
E140-S1225-2 C-G	E140 DRIFT-S1225	4-93	06/25/07	14.520	15.477	1.73	1.64	5%	
E140-S1300-4 A-C	E140 DRIFT-S1300	4-94	06/25/07	12.506	29.129	1.33	1.36	-2%	
E140-S1378-2 A-E	E140 DRIFT-S1378	4-95	06/25/07	17.204	28.042	1.96	1.99	-2%	
E140-S1378-2 B-D	E140 DRIFT-S1378	4-95	06/25/07	11.502	21.206	1.33	1.27	5%	
E140-S1378-2 H-F	E140 DRIFT-S1378	4-95	06/25/07	19.719	30.997	2.20	2.16	2%	
E140-S1378 C-G	E140 DRIFT-S1378	4-96	06/25/07	14.335	18.505	1.35	1.31	3%	
E140-S1456-4 A-G	E140 DRIFT-S1450	4-97	06/25/07	23.808	58.877	4.14	3.53	17%	
E140-S1456-2 B-F	E140 DRIFT-S1456	4-98	06/25/07	21.813	31.981	2.74	2.58	6%	
E140-S1456-2 L-H	E140 DRIFT-S1456	4-98	06/25/07	17.148	25.918	2.48	2.13	16%	
E140-S1456-2 D-J	E140 DRIFT-S1456	4-99	06/25/07	14.623	35.971	1.55	1.53	1%	
E140-S1456 K-C	E140 DRIFT-S1456	4-100	06/25/07	13.913	13.913	1.31	1.24	6%	
E140-S1456-2 I-E	E140 DRIFT-S1456	4-100	06/25/07	12.154	43.830	1.30	1.23	6%	
E140-S1534-2 A-E	E140 DRIFT-S1534	4-101	06/25/07	33.993	37.154	2.75	2.91	-5%	
E140-S1534-3 B-D	E140 DRIFT-S1534	4-101	06/25/07	8.579	22.023	2.20	2.36	-7%	
E140-S1534-2 H-F	E140 DRIFT-S1534	4-101	06/25/07	22.007	25.077	2.10	2.07	1%	
E140-S1534-2 C-G	E140 DRIFT-S1534	4-101	06/25/07	13.195	14.718	1.38	1.37	1%	
E140-S1600-5 A-C	E140 DRIFT-S1600	4-102	06/25/07	14.553	31.398	1.58	1.68	-6%	
E140-S1687-2 A-E	E140 DRIFT-S1687	4-103	06/25/07	26.250	29.208	3.76	4.25	-12%	
E140-S1687-2 B-D	E140 DRIFT-S1687	4-103	06/25/07	20.302	23.186	2.57	2.79	-8%	
E140-S1687-2 H-F	E140 DRIFT-S1687	4-103	06/25/07	18.419	21.015	2.52	2.66	-5%	
E140-S1687 C-G	E140 DRIFT-S1687	4-103	06/25/07	14.622	14.622	1.53	1.46	5%	
E140-S1775-2 A-G	E140 DRIFT-S1775	4-104	06/25/07	42.162	45.389	4.45	4.82	-8%	
E140-S1775-3 B-F	E140 DRIFT-S1775	4-104	06/25/07	12.813	37.419	3.64	3.82	-5%	
E140-S1775-2 L-H	E140 DRIFT-S1775	4-104	06/25/07	18.375	20.561	2.09	2.23	-6%	

**Table 4-1 (Continued)  
Access Drifts Data Analysis**

**CONVERGENCE POINTS (Continued)**

Field Tag	Location	Figure Number	Last Reading 2006 to 2007		Cumulative Displacement (inches)	Closure Rate 2006 to 2007 (in/year)	Closure Rate 2005 to 2006 (in/year)	Rate Change Percent	Comments
			Date	Inches					
E140-S1775 C-K	E140 DRIFT-S1775	4-105	06/25/07	14.560	14.560	1.45	1.40	4%	
E140-S1775-2 D-J	E140 DRIFT-S1775	4-105	06/25/07	14.193	15.503	1.63	1.62	1%	
E140-S1775-3 I-E	E140 DRIFT-S1775	4-105	06/25/07	0.546	14.886	1.68	1.39	21%	
E140-S1862-2 A-E	E140 DRIFT-S1862	4-106	06/25/07	29.205	31.811	4.10	4.81	-15%	
E140-S1862-2 B-D	E140 DRIFT-S1862	4-106	06/25/07	25.698	28.614	3.55	3.97	-11%	
E140-S1862-2 H-F	E140 DRIFT-S1862	4-106	06/25/07	14.297	16.128	1.73	1.84	-6%	
E140-S1862-3 C-G	E140 DRIFT-S1862	4-106	06/25/07	8.111	14.516	1.49	1.50	-1%	
E140-S1950-5 A-C	E140 DRIFT-S1950	4-107	06/25/07	10.324	40.434	2.19	2.53	-13%	
E140-S2007-5 A-C	E140 DRIFT-S2007	4-108	06/25/07	6.887	24.977	2.64	2.81	-6%	
E140-S2065-4 A-C	E140 DRIFT-S2065	4-109	06/25/07	9.017	26.830	3.62	3.55	2%	
E140-S2065-2 B-D	E140 DRIFT-S2065	4-109	06/25/07	7.594	14.294	1.70	1.70	0%	
E140-S2122-3 A-C	E140 DRIFT-S2122	4-110	06/25/07	13.366	26.916	3.16	3.13	1%	
E140-S2180-5 A-C	E140 DRIFT-S2180	4-111	06/25/07	6.489	29.869	2.56	2.68	-4%	
E140-S2275-3 A-C	E140 DRIFT-S2275	4-112	06/25/07	17.449	43.205	8.37	6.53	28%	
E140-S2275 B-D	E140 DRIFT-S2275	4-112	06/25/07	14.784	14.784	2.02	1.94	4%	
E140-S2350-4 A-C	E140 DRIFT-S2350	4-113	06/25/07	12.344	48.330	5.30	4.85	9%	
E140-S2350-2 B-D	E140 DRIFT-S2350	4-113	06/25/07	15.549	22.440	2.08	2.07	0%	
E140-S2425-3 A-C	E140 DRIFT-S2425	4-114	06/25/07	10.721	28.012	4.46	4.25	5%	
E140-S2425 B-D	E140 DRIFT-S2425	4-114	06/25/07	15.345	15.345	2.01	2.00	0%	
E140-S2520-2 A-C	E140 DRIFT-S2520	4-115	06/25/07	14.104	22.754	2.93	3.44	-15%	
E140-S2634 A-C	E140 DRIFT-S2634	4-116	06/25/07	24.759	24.759	6.27	5.22	20%	
E140-S2634 B-D	E140 DRIFT-S2634	4-116	06/26/07	9.396	9.396	2.07	2.01	3%	
E140-S2750-2 A-C	E140 DRIFT-S2750	4-117	06/25/07	7.114	11.143	2.24	2.41	-7%	
E140-S2833-2 A-C	E140 DRIFT-S2833	4-118	06/26/07	9.395	15.731	3.04	3.01	1%	
E140-S2833 B-D	E140 DRIFT-S2833	4-118	06/26/07	8.504	8.504	1.69	1.66	2%	
E140-S2915-2 A-C	E140 DRIFT-S2915	4-119	06/26/07	11.391	20.258	3.68	3.65	1%	
E140-S2915 B-D	E140 DRIFT-S2915	4-119	06/26/07	9.320	9.320	1.84	1.87	-2%	
E140-S2998-2 A-C	E140 DRIFT-S2998	4-120	06/26/07	12.238	21.383	4.03	3.96	2%	

**Table 4-1 (Continued)  
Access Drifts Data Analysis**

**CONVERGENCE POINTS (Continued)**

Field Tag	Location	Figure Number	Last Reading 2006 to 2007		Cumulative Displacement (inches)	Closure Rate 2006 to 2007 (in/year)	Closure Rate 2005 to 2006 (in/year)	Rate Change Percent	Comments
			Date	Inches					
E140-S2998 B-D	E140 DRIFT-S2998	4-120	06/26/07	8.800	8.800	1.71	1.77	-3%	
E140-S3080 A-C	E140 DRIFT-S3080	4-121	06/26/07	12.235	12.235	2.31	2.70	-14%	
E140-S3195 A-C	E140 DRIFT-S3195	4-122	06/26/07	20.592	20.592	3.78	4.74	-20%	
E140-S3195 B-D	E140 DRIFT-S3195	4-122	06/26/07	8.973	8.973	1.78	1.90	-6%	
E140-S3295 A-C	E140 DRIFT-S3295	4-123	06/26/07	4.262	4.262	2.38	2.76	-14%	
E140-S3325 A-C	E140 DRIFT-S3325	4-124	06/26/07	4.370	4.370	2.42	2.79	-13%	
E140-S3395 A-C	E140 DRIFT-S3395	4-125	06/26/07	10.174	10.174	3.84	4.71	-18%	
E140-S3395 B-D	E140 DRIFT-S3395	4-125	06/26/07	4.386	4.386	1.74	2.04	-15%	
E140-S3480 A-C	E140 DRIFT-S3480	4-126	06/26/07	8.701	8.701	3.72	4.05	-8%	
E140-S3480 B-D	E140 DRIFT-S3480	4-126	06/26/07	4.594	4.594	1.81	2.12	-15%	
E140-S3565 A-C	E140 DRIFT-S3565	4-127	06/26/07	6.999	6.999	2.94	3.28	-10%	
E140-S3565 B-D	E140 DRIFT-S3565	4-127	06/26/07	4.062	4.062	1.77	2.04	-13%	
E140-S3650 A-C	E140 DRIFT-S3650	4-128	05/21/07	3.694	3.694	2.01	2.20	-9%	
E0-N1420-2 A-C	E0 DRIFT-N1420	4-129	06/11/07	3.327	3.327	1.28	1.28	0%	
E0-N1266-4 A-C	E0 DRIFT-N1266	4-130	06/11/07	9.081	46.007	2.39	2.32	3%	
E0-N1110-5 A-C	E0 DRIFT-N1110	4-131	06/11/07	4.105	38.585	1.52	1.51	1%	
E0-N940-5 A-C	E0 DRIFT-N940	4-132	06/11/07	5.911	46.685	1.53	2.19	-30%	
E0-N780-2 A-C	E0 DRIFT-N780	4-133	06/11/07	8.035	28.475	1.95	1.91	2%	
E0-N686 A-C	E0 DRIFT-N686	4-134	06/11/07	9.702	9.702	2.19	2.04	7%	
E0-N686 B-D	E0 DRIFT-N686	4-134	06/11/07	6.572	6.572	1.74	1.30	34%	
E0-N626-4 A-C	E0 DRIFT-N626	4-135	06/11/07	9.197	50.175	2.04	1.78	15%	
E0-N562 A-C	E0 DRIFT-N562	4-136	06/11/07	7.285	7.285	1.69	1.55	9%	
E0-N562 B-D	E0 DRIFT-N562	4-136	06/11/07	6.694	6.694	1.57	1.35	16%	
E0-N460-3 A-C	E0 DRIFT-N460	4-137	06/11/07	11.644	31.791	1.85	1.63	13%	
E0-N300-5 A-C	E0 DRIFT-N290	4-138	06/21/07	5.585	45.260	1.63	1.51	8%	

**Table 4-1 (Continued)  
Access Drifts Data Analysis**

**CONVERGENCE POINTS (Continued)**

Field Tag	Location	Figure Number	Last Reading 2006 to 2007		Cumulative Displacement (inches)	Closure Rate 2006 to 2007 (in/year)	Closure Rate 2005 to 2006 (in/year)	Rate Change Percent	Comments
			Date	Inches					
E0-N225-2 A-C	E0 DRIFT-N225	4-139	06/21/07	10.119	10.210	1.71	1.55	10%	
E0-N225 B-D	E0 DRIFT-N225	4-139	06/11/07	8.867	8.867	1.41	1.32	7%	
E0-N75 A-C	E0 DRIFT-N80	4-140	06/11/07	10.196	27.216	1.80	1.67	8%	
E0-N75 B-D	E0 DRIFT-N80	4-140	06/11/07	7.211	7.211	1.31	1.22	7%	
W30-S120-2 A-C	W30 DRIFT-S120	4-141	06/11/07	0.675	20.687	1.13	0.88	28%	
W30-S250-5 A-C	W30 DRIFT-S250	4-142	06/11/07	0.560	26.835	1.30	0.84	55%	
W30-S250-5 B-D	W30 DRIFT-S250	4-142	06/11/07	12.271	23.225	1.10	0.71	55%	
W30-S400-2 A-C	W30 DRIFT-S400	4-143	06/11/07	0.536	18.383	1.04	0.73	42%	
W30-S500 B-D	W30 DRIFT-S500	4-144	06/11/07	21.983	21.983	1.07	0.68	57%	
W30-S500-2 A-C	W30 DRIFT-S500	4-144	06/11/07	0.633	23.164	1.23	0.73	68%	
W30-S700-4 A-C	W30 DRIFT-S700	4-145	06/11/07	0.636	30.182	1.68	0.86	95%	
W30-S850-3 A-E	W30 DRIFT-S850	4-146	06/11/07	0.438	17.903	0.98	0.58	69%	
W30-S850-3 B-D	W30 DRIFT-S850	4-146	06/11/07	0.307	12.229	0.73	0.38	92%	
W30-S850-2 H-F	W30 DRIFT-S850	4-146	06/11/07	0.364	13.351	0.78	0.39	100%	
W30-S850 C-G	W30 DRIFT-S850	4-146	06/11/07	20.115	20.115	0.93	0.63	48%	
W30-S1000-3 A-C	W30 DRIFT-S1000	4-147	06/11/07	17.739	34.606	1.44	1.11	30%	
W30-S1100 A-C	W30 DRIFT-S1100	4-148	06/12/07	11.061	11.061	0.97	0.84	15%	
W30-S1200 A-C	W30 DRIFT-S1200	4-149	06/12/07	11.131	11.131	0.89	0.86	3%	
W30-S1300 A-C	W30 DRIFT-S1300	4-150	06/12/07	18.743	18.743	1.22	1.01	21%	
W30-S1453 A-C	W30 DRIFT-S1453	4-151	06/12/07	13.053	13.053	0.92	0.78	18%	
W30-S1453-2 B-D	W30 DRIFT-S1453	4-151	06/12/07	8.118	13.041	0.87	0.71	23%	
W30-S1600-2 A-C	W30 DRIFT-S1600	4-152	06/12/07	8.258	17.000	1.08	0.93	16%	
W30-S1775 A-C	W30 DRIFT-S1775	4-153	06/12/07	9.540	9.540	0.64	0.55	16%	
W30-S1775-2 B-D	W30 DRIFT-S1775	4-153	06/12/07	7.433	11.473	0.83	0.67	24%	
W30-S1950 A-C	W30 DRIFT-S1950	4-154	06/12/07	16.396	16.396	1.07	0.95	13%	

**Table 4-1 (Continued)  
Access Drifts Data Analysis**

**CONVERGENCE POINTS (Continued)**

Field Tag	Location	Figure Number	Last Reading 2006 to 2007		Cumulative Displacement (inches)	Closure Rate 2006 to 2007 (in/year)	Closure Rate 2005 to 2006 (in/year)	Rate Change Percent	Comments
			Date	Inches					
W30-S2067 A-C	W30 DRIFT-S2067	4-155	06/12/07	12.826	12.826	0.97	0.85	14%	
W30-S2067-2 B-D	W30 DRIFT-S2067	4-155	06/12/07	8.608	13.517	1.03	0.87	18%	
W30-S2180 A-C	W30 DRIFT-S2180	4-156	06/12/07	20.108	20.108	1.15	1.54	-25%	
W30-S2275-2 A-C	W30 DRIFT-S2275	4-157	06/12/07	6.701	7.540	0.97	0.87	11%	
W30-S2275 B-D	W30 DRIFT-S2275	4-157	06/12/07	8.829	8.829	1.14	1.02	12%	
W30-S2350-2 A-C	W30 DRIFT-S2350	4-158	06/12/07	7.338	8.426	1.03	0.93	11%	
W30-S2350 B-D	W30 DRIFT-S2350	4-158	06/12/07	9.908	9.908	1.24	1.12	11%	
W30-S2425-2 A-C	W30 DRIFT-S2425	4-159	06/12/07	7.778	8.767	1.10	0.97	13%	
W30-S2425 B-D	W30 DRIFT-S2425	4-159	06/12/07	10.494	10.494	1.38	1.22	13%	
W30-S2520-2 A-C	W30 DRIFT-S2520	4-160	06/12/07	11.623	13.544	1.55	1.40	11%	
W30-S2685-2 A-C	W30 DRIFT-S2685	4-161	06/12/07	10.464	12.598	1.87	1.68	11%	
W30-S2685-2 B-D	W30 DRIFT-S2685	4-161	06/12/07	8.439	10.619	1.46	1.29	13%	
W30-S2750 A-C	W30 DRIFT-S2750	4-162	06/12/07	7.227	7.227	1.43	1.38	4%	
W30-S2833 A-C	W30 DRIFT-S2833	4-163	06/12/07	6.933	6.933	1.62	1.42	14%	
W30-S2833 B-D	W30 DRIFT-S2833	4-163	06/12/07	6.646	6.646	1.47	1.31	12%	
W30-S2916 A-C	W30 DRIFT-S2916	4-164	06/12/07	10.678	10.678	3.13	2.29	37%	
W30-S2916 B-D	W30 DRIFT-S2916	4-164	06/12/07	6.072	6.072	1.37	1.20	14%	
W30-S2998 A-C	W30 DRIFT-S2998	4-165	06/12/07	6.665	6.665	1.47	1.31	12%	
W30-S2998 B-D	W30 DRIFT-S2998	4-165	06/12/07	6.389	6.389	1.36	1.24	10%	
W30-S3080 A-C	W30 DRIFT-S3080	4-166	06/12/07	12.062	12.062	2.48	2.19	13%	
W30-S3195 A-C	W30 DRIFT-S3195	4-167	06/12/07	7.890	7.890	1.92	1.53	25%	
W30-S3195 B-D	W30 DRIFT-S3195	4-167	06/12/07	6.810	6.810	1.39	1.27	9%	
W30-S3310 A-C	W30 DRIFT-S3310	4-168	06/12/07	8.392	8.392	1.75	1.55	13%	
W30-S3395 A-C	W30 DRIFT-S3395	4-169	06/12/07	3.911	3.911	1.96	1.69	16%	
W30-S3395 B-D	W30 DRIFT-S3395	4-169	06/12/07	3.439	3.439	1.71	1.50	14%	

**Table 4-1 (Continued)**  
**Access Drifts Data Analysis**

**CONVERGENCE POINTS (Continued)**

Field Tag	Location	Figure Number	Last Reading 2006 to 2007		Cumulative Displacement (inches)	Closure Rate 2006 to 2007 (in/year)	Closure Rate 2005 to 2006 (in/year)	Rate Change Percent	Comments
			Date	Inches					
W30-S3480 A-C	W30 DRIFT-S3480	4-170	06/12/07	4.045	4.045	2.04	1.74	17%	
W30-S3480 B-D	W30 DRIFT-S3480	4-170	06/12/07	3.377	3.377	1.65	1.47	12%	
W30-S3565 A-C	W30 DRIFT-S3565	4-171	06/12/07	3.558	3.558	1.78	1.54	16%	
W30-S3565 B-D	W30 DRIFT-S3565	4-171	06/12/07	3.409	3.409	1.67	1.46	14%	
W30-S3650 A-C	W30 DRIFT-S3650	4-172	05/21/07	3.087	3.087	2.00	1.59	26%	
W170-N150-2 A-C	W170 DRIFT-N150	4-173	05/17/07	6.927	8.373	0.47	0.47	0%	
W170-S5 A-C	W170 DRIFT-S5	4-174	05/17/07	12.395	12.395	0.59	0.65	-9%	
W170-S5-2 B-D	W170 DRIFT-S5	4-174	05/17/07	6.304	14.096	0.72	0.66	9%	
W170-S90-3 A-C	W170 DRIFT-S90	4-175	05/14/07	4.542	11.812	0.90	0.83	8%	
W170-S232-2 A-C	W170 DRIFT-S232	4-176	05/17/07	3.882	9.494	0.61	0.57	7%	
W170-S232-2 B-D	W170 DRIFT-S232	4-176	05/17/07	6.995	9.637	0.59	0.54	9%	
W170-S400 A-C	W170 DRIFT-S400	4-177	05/14/07	11.506	11.506	0.66	0.62	6%	
W170-S560-3 A-C	W170 DRIFT-S560	4-178	05/14/07	4.189	10.284	0.64	0.61	5%	
W170-S560-2 B-D	W170 DRIFT-S560	4-178	05/14/07	7.919	11.051	0.71	0.60	18%	
W170-S700 A-C	W170 DRIFT-S700	4-179	05/14/07	19.250	19.250	0.71	0.66	8%	
W170-S850-6 A-E	W170 DRIFT-S850	4-180	05/14/07	4.056	16.545	0.71	0.59	20%	
W170-S850-5 B-D	W170 DRIFT-S850	4-181	05/14/07	3.393	12.392	0.58	0.49	18%	
W170-S850-6 H-F	W170 DRIFT-S850	4-181	05/14/07	2.953	11.333	0.51	0.43	19%	
W170-S850-3 C-G	W170 DRIFT-S850	4-182	05/14/07	7.923	18.736	0.70	0.65	8%	
W170-S1000-2 A-C	W170 DRIFT-S1000	4-183	05/14/07	5.528	22.212	0.89	0.91	-2%	
W170-S1150-3 A-E	W170 DRIFT-S1150	4-184	05/14/07	6.533	19.805	0.83	0.82	1%	
W170-S1150-3 B-D	W170 DRIFT-S1150	4-184	05/14/07	4.580	13.818	0.62	0.55	13%	
W170-S1150-2 C-G	W170 DRIFT-S1150	4-184	05/14/07	8.716	20.293	0.83	0.75	11%	
W170-S1150 H-F	W170 DRIFT-S1150	4-184	05/14/07	12.996	12.996	0.63	0.40	57%	
W170-S1300-3 A-C	W170 DRIFT-S1300	4-185	05/14/07	16.715	19.795	1.31	1.33	-2%	

**Table 4-1 (Continued)  
Access Drifts Data Analysis**

**CONVERGENCE POINTS (Continued)**

Field Tag	Location	Figure Number	Last Reading 2006 to 2007		Cumulative Displacement (inches)	Closure Rate 2006 to 2007 (in/year)	Closure Rate 2005 to 2006 (in/year)	Rate Change Percent	Comments
			Date	Inches					
W170-S1445-3 A-C	W170 DRIFT-S1445	4-186	05/14/07	6.006	10.741	0.73	0.67	9%	
W170-S1445-2 B-D	W170 DRIFT-S1445	4-186	05/14/07	7.748	10.406	0.77	0.62	24%	
W170-S1600-2 A-C	W170 DRIFT-S1600	4-187	05/14/07	7.476	13.274	0.87	0.87	0%	
W170-S1779-2 A-C	W170 DRIFT-S1779	4-188	05/14/07	7.957	14.188	0.99	0.95	4%	
W170-S1779-2 B-D	W170 DRIFT-S1779	4-188	05/14/07	9.245	12.380	0.94	0.80	17%	
W170-S1950-2 A-C	W170 DRIFT-S1950	4-189	05/14/07	7.095	12.518	0.84	0.71	18%	
W170-S2060-2 A-C	W170 DRIFT-S2060	4-190	05/14/07	7.463	13.021	0.93	0.87	7%	
W170-S2060-2 B-D	W170 DRIFT-S2060	4-190	05/14/07	9.811	13.135	1.01	0.91	11%	
W170-S2180-2 A-C	W170 DRIFT-S2180	4-191	05/14/07	9.337	15.352	1.07	1.03	4%	
W170-S2275 A-C	W170 DRIFT-S2275	4-192	05/14/07	8.007	8.007	1.01	0.96	5%	
W170-S2275 B-D	W170 DRIFT-S2275	4-192	05/14/07	8.600	8.600	1.12	1.07	5%	
W170-S2350 A-C	W170 DRIFT-S2350	4-193	05/14/07	10.533	10.533	1.31	1.25	5%	
W170-S2350 B-D	W170 DRIFT-S2350	4-193	05/14/07	8.893	8.893	1.12	1.00	12%	
W170-S2425 A-C	W170 DRIFT-S2425	4-194	05/14/07	9.474	9.474	1.12	1.08	4%	
W170-S2425 B-D	W170 DRIFT-S2425	4-194	05/14/07	9.730	9.730	1.21	1.12	8%	
W170-S2520 A-C	W170 DRIFT-S2520	4-195	05/14/07	10.521	10.521	1.29	1.21	7%	
W170-S2685-2 A-C	W170 DRIFT-S2685	4-196	05/17/07	11.078	12.944	2.77	2.33	19%	
W170-S2685-2 B-D	W170 DRIFT-S2685	4-196	05/17/07	7.841	9.737	1.46	1.30	12%	
W170-S2750 A-C	W170 DRIFT-S2750	4-197	05/14/07	6.886	6.886	1.44	1.46	-1%	
W170-S2833 A-C	W170 DRIFT-S2833	4-198	05/14/07	6.796	6.796	1.67	1.44	16%	
W170-S2833 B-D	W170 DRIFT-S2833	4-198	05/14/07	5.678	5.678	1.25	1.12	12%	
W170-S2916 A-C	W170 DRIFT-S2916	4-199	05/15/07	12.247	12.247	1.94	1.80	8%	
W170-S2916 B-D	W170 DRIFT-S2916	4-199	05/15/07	5.883	5.883	1.40	1.26	11%	
W170-S2998 A-C	W170 DRIFT-S2998	4-200	05/14/07	9.185	9.185	2.59	1.91	36%	
W170-S2998 B-D	W170 DRIFT-S2998	4-200	05/14/07	6.439	6.439	1.45	1.28	13%	

**Table 4-1 (Continued)  
Access Drifts Data Analysis**

**CONVERGENCE POINTS (Continued)**

Field Tag	Location	Figure Number	Last Reading 2006 to 2007		Cumulative Displacement (inches)	Closure Rate 2006 to 2007 (in/year)	Closure Rate 2005 to 2006 (in/year)	Rate Change Percent	Comments
			Date	Inches					
W170-S3080 A-C	W170 DRIFT-S3080	4-201	05/14/07	7.058	7.058	1.66	1.48	12%	
W170-S3195 A-C	W170 DRIFT-S3195	4-202	05/14/07	7.716	7.716	2.03	1.40	45%	
W170-S3195 B-D	W170 DRIFT-S3195	4-202	05/14/07	6.503	6.503	1.58	1.16	36%	
W170-S3310 A-C	W170 DRIFT-S3310	4-203	05/14/07	8.644	8.644	3.52	1.38	155%	
W170-S3395 A-C	W170 DRIFT-S3395	4-204	05/15/07	3.736	3.736	2.61	1.59	64%	
W170-S3395 B-D	W170 DRIFT-S3395	4-204	05/15/07	3.144	3.144	2.22	1.26	76%	
W170-S3480 A-C	W170 DRIFT-S3480	4-205	05/15/07	4.110	4.110	2.91	1.72	69%	
W170-S3480 B-D	W170 DRIFT-S3480	4-205	05/15/07	3.962	3.962	2.88	1.59	81%	
W170-S3565 A-C	W170 DRIFT-S3565	4-206	05/15/07	3.544	3.544	2.39	1.51	58%	
W170-S3565 B-D	W170 DRIFT-S3565	4-206	05/15/07	3.336	3.336	2.32	1.34	73%	
W170-S3650 A-C	W170 DRIFT-S3650	4-207	05/21/07	4.680	4.680	3.22	1.21	166%	
N780-E70 A-C	N780 DRIFT-E70	4-208	06/11/07	6.015	6.015	1.34	1.36	-1%	
N780-E70 B-D	N780 DRIFT-E70	4-208	06/11/07	6.038	6.038	1.35	1.35	0%	
N460-E70-3 A-C	N460 DRIFT-E70	4-209	06/11/07	9.908	26.420	1.31	1.22	7%	
N460-E70-2 B-D	N460 DRIFT-E70	4-209	06/11/07	8.871	20.619	1.42	1.35	5%	
N300-W170-2 A-C	N300 DRIFT-W170	4-210	06/21/07	5.960	28.238	1.65	1.70	-3%	
N300-W170-2 B-D	N300 DRIFT-W170	4-210	06/21/07	10.473	18.718	1.30	1.28	2%	
N250-E220-2 A-E	N250 DRIFT-E220	4-211	06/08/07	1.714	25.342	2.37	1.48	60%	
N250-E220-2 B-D	N250 DRIFT-E220	4-211	06/08/07	1.138	26.081	1.56	1.64	-5%	
N250-E220-2 H-F	N250 DRIFT-E220	4-211	06/08/07	1.083	19.509	1.47	1.06	39%	
N250-E220 C-G	N250 DRIFT-E220	4-211	06/08/07	18.757	18.757	1.40	0.98	43%	
N215-W500-2 A-C	N215 DRIFT-W500	4-212	06/21/07	4.965	23.312	1.38	1.43	-3%	
N215-W500-2 B-D	N215 DRIFT-W500	4-212	06/21/07	8.319	15.189	0.95	0.89	7%	
N215-W620-2 A-C	N215 DRIFT-W620	4-213	06/21/07	3.334	19.572	1.04	1.09	-5%	
N140-E90 A-C	N140 DRIFT-E90	4-214	06/21/07	14.158	14.158	0.82	0.71	15%	



**Table 4-1 (Continued)  
Access Drifts Data Analysis**

**CONVERGENCE POINTS (Continued)**

Field Tag	Location	Figure Number	Last Reading 2006 to 2007		Cumulative Displacement (inches)	Closure Rate 2006 to 2007 (in/year)	Closure Rate 2005 to 2006 (in/year)	Rate Change Percent	Comments
			Date	Inches					
N140-E90 B-D	N140 DRIFT-E90	4-214	06/21/07	14.630	14.630	0.87	0.67	30%	
N140-W50-2 B-D	N140 DRIFT-W50	4-215	05/17/07	9.532	21.738	0.83	1.02	-19%	
S90-W120 A-C	S90 DRIFT-W120	4-216	05/17/07	4.734	4.734	0.62	0.59	5%	
S90-W120 B-D	S90 DRIFT-W120	4-216	05/17/07	5.030	5.030	0.70	0.63	11%	
S90-W400-2 A-C	S90 DRIFT-W400	4-217	11/29/06	1.161	14.534	0.74	0.58	28%	
S90-W400-2 B-D	S90 DRIFT-W400	4-217	05/17/07	6.385	14.308	0.66	0.63	5%	
S90-W590-2 A-C	S90 DRIFT-W590	4-218	11/29/06	1.087	10.438	0.66	0.54	22%	
S90-W590-2 B-D	S90 DRIFT-W590	4-218	05/17/07	6.073	9.910	0.60	0.57	5%	
S90-W620 A-C	S90 DRIFT-W620	4-219	05/17/07	19.906	19.906	0.98	1.02	-4%	
S90-W770 A-C	S90 DRIFT-W770	4-220	05/17/07	13.646	13.646	0.81	0.81	0%	
S90-W770-2 B-D	S90 DRIFT-W770	4-220	05/17/07	6.918	12.605	0.84	0.81	4%	
S90-W905 A-C	S90 DRIFT-W905	4-221	05/17/07	6.544	6.544	1.67	1.90	-12%	
CORE-W10 A-C	CORE STORAGE W10	4-222	05/17/07	18.245	18.245	0.83	0.84	-1%	
CORE-W101 A-C	CORE STORAGE W101	4-222	05/17/07	20.705	20.705	1.18	1.09	8%	
CORE-W117 A-C	CORE STORAGE W117	4-222	05/17/07	18.765	18.765	1.01	0.98	3%	
CORE-W133 A-C	CORE STORAGE W133	4-222	05/17/07	15.998	15.998	0.81	0.78	4%	
CORE-W20 A-C	CORE STORAGE W20	4-222	05/17/07	17.111	17.111	0.85	0.83	2%	
CORE-W30 A-C	CORE STORAGE W30	4-222	05/17/07	17.858	17.858	0.92	0.89	3%	
CORE-W51 A-C	CORE STORAGE W51	4-222	05/17/07	20.169	20.169	1.15	1.07	7%	
CORE-W62 A-C	CORE STORAGE W62	4-222	05/17/07	20.986	20.986	1.21	1.14	6%	
CORE-W73 A-C	CORE STORAGE W73	4-222	05/17/07	21.196	21.196	1.24	1.17	6%	
S700-E55 A-C	S700 DRIFT-E55	4-223	05/24/07	2.243	2.243	0.77	0.70	10%	
S700-E55 B-D	S700 DRIFT-E55	4-223	05/24/07	2.256	2.256	0.81	0.66	23%	
S700-W98-2 A-C	S700 DRIFT-W98	4-224	05/24/07	2.842	17.343	1.29	1.25	3%	
S1000-E160-2 A-C	S1000 DRIFT-E160	4-225	05/24/07	1.883	7.814	0.70	0.75	-7%	

**Table 4-1 (Continued)**  
**Access Drifts Data Analysis**

**CONVERGENCE POINTS (Continued)**

Field Tag	Location	Figure Number	Last Reading 2006 to 2007		Cumulative Displacement (inches)	Closure Rate 2006 to 2007 (in/year)	Closure Rate 2005 to 2006 <sup>1</sup> (in/year)	Rate Change Percent <sup>1</sup>	Comments
			Date	Inches					
S1000-E120-3 A-C	S1000 DRIFT-E120	4-226	05/24/07	2.498	10.977	0.90	1.00	-10%	
S1000-E58-4 A-C	S1000 DRIFT-E58	4-227	05/24/07	2.623	18.108	1.06	1.11	-5%	
S1000-E58-2 B-D	S1000 DRIFT-E58	4-227	05/24/07	12.986	12.986	0.95	0.90	6%	
S1000-W98-2 A-C	S1000 DRIFT-W98	4-228	05/24/07	5.700	24.469	1.67	1.70	-2%	
S1300-E160 A-C	S1300 DRIFT-E160	4-229	05/24/07	14.219	14.219	1.26	1.36	-7%	
S1300-E120 A-C	S1300 DRIFT-E120	4-230	05/24/07	10.116	10.116	0.80	0.88	-9%	
S1300-E24 A-C	S1300 DRIFT-E24	4-231	05/24/07	16.591	16.591	1.09	0.96	14%	
S1300-W100-3 A-C	S1300 DRIFT-W100	4-232	05/24/07	1.267	25.297	1.67	N/A	N/A	Instrument reinstalled after mining.
S1600-E170 A-C	S1600 DRIFT-E170	4-233	05/24/07	11.830	11.830	0.91	1.01	-10%	
S1600-E110 A-C	S1600 DRIFT-E110	4-234	05/24/07	10.781	10.781	0.83	0.92	-10%	
S1950-E113-4 A-C	S1950 DRIFT-E113	4-235	05/24/07	4.681	8.608	0.69	0.66	5%	
S1950-E281-3 A-C	S1950 DRIFT-E281	4-236	05/25/07	9.554	16.123	1.10	1.05	5%	
S1950-E284-3 A-C	S1950 DRIFT-E284	4-237	05/25/07	9.647	16.286	1.12	1.07	5%	
S2180-E55-2 A-C	S2180 DRIFT-E55	4-238	05/24/07	8.664	8.984	1.36	1.29	5%	
S2180-E55 B-D	S2180 DRIFT-E55	4-238	05/24/07	7.116	7.116	1.12	1.00	12%	
S2180-E220 A-C	S2180 DRIFT-E220	4-239	05/24/07	8.708	8.708	1.26	1.23	2%	
S2180-E220 B-D	S2180 DRIFT-E220	4-239	05/24/07	9.189	9.189	1.40	1.36	3%	
S2180-W100-2 A-C	S2180 DRIFT-W100	4-240	05/24/07	10.994	11.143	1.77	1.65	7%	
S2180-W100-2 B-D	S2180 DRIFT-W100	4-240	05/24/07	6.925	7.111	1.12	0.95	18%	
S2520-E220 A-C	S2520 DRIFT-E220	4-241	05/24/07	12.430	12.430	1.49	1.45	3%	
S2520-E220 B-D	S2520 DRIFT-E220	4-241	05/24/07	12.388	12.388	1.56	1.51	3%	
S2520-W100 A-C	S2520 DRIFT-W100	4-242	05/24/07	11.568	11.568	1.43	1.32	8%	
S2520-W100 B-D	S2520 DRIFT-W100	4-242	05/24/07	11.244	11.244	1.47	1.27	16%	
S2750-E55 A-C	S2750 DRIFT-E55	4-243	05/24/07	8.038	8.038	2.23	1.56	43%	
S2750-E55 B-D	S2750 DRIFT-E55	4-243	05/24/07	6.785	6.785	1.57	1.38	14%	
S2750-E220 A-C	S2750 DRIFT-E220	4-244	01/29/07	8.444	8.444	2.14	2.16	-1%	

<sup>1</sup> NA indicates insufficient data to compare annualized rates.

**Table 4-1 (Continued)  
Access Drifts Data Analysis**

**CONVERGENCE POINTS (Continued)**

Field Tag	Location	Figure Number	Last Reading 2006 to 2007		Cumulative Displacement (inches)	Closure Rate 2006 to 2007 (in/year)	Closure Rate 2005 to 2006 <sup>1</sup> (in/year)	Rate Change Percent <sup>1</sup>	Comments
			Date	Inches					
S2750-E220 B-D	S2750 DRIFT-E220	4-244	05/22/07	7.230	7.230	1.51	1.42	6%	
S2750-W93 A-C	S2750 DRIFT-W93	4-245	05/24/07	8.130	8.130	2.14	1.84	16%	
S2750-W93 B-D	S2750 DRIFT-W93	4-245	05/24/07	5.242	5.242	1.22	1.05	16%	
S3080-E55 A-C	S3080 DRIFT-E55	4-246	05/22/07	8.665	8.665	2.25	1.65	36%	
S3080-E55-2 B-D	S3080 DRIFT-E55	4-246	05/22/07	4.742	6.442	1.39	1.34	4%	
S3080-E220-2 A-C	S3080 DRIFT-E220	4-247	01/30/07	4.786	7.520	1.83	1.84	-1%	
S3080-E220 B-D	S3080 DRIFT-E220	4-247	05/22/07	7.608	7.608	1.50	1.60	-6%	
S3080-W100 A-C	S3080 DRIFT-W100	4-248	05/24/07	8.004	8.004	2.10	1.76	19%	
S3080-W100 B-D	S3080 DRIFT-W100	4-248	05/24/07	6.251	6.251	1.44	1.22	18%	
S3310-E55 A-C	S3310 DRIFT-E55	4-249	05/22/07	8.784	8.784	2.44	1.77	38%	
S3310-E55 B-D	S3310 DRIFT-E55	4-249	05/22/07	7.442	7.442	1.62	1.52	7%	
S3310-E220 A-C	S3310 DRIFT-E220	4-250	05/24/07	8.944	8.944	1.79	2.04	-12%	
S3310-E220 B-D	S3310 DRIFT-E220	4-250	05/24/07	8.889	8.889	1.79	2.06	-13%	
S3310-W100-3 A-C	S3310 DRIFT-W100	4-251	05/22/07	0.830	7.136	2.42	1.73	40%	
S3310-W100 B-D	S3310 DRIFT-W100	4-251	05/22/07	6.931	6.931	1.75	1.55	13%	
S3650-E55 A-C	S3650 DRIFT-E55	4-252	05/21/07	0.997	0.997	1.70	N/A	N/A	Not installed 2005-2006.
S3650-E220 A-C	S3650 DRIFT-E220	4-253	05/21/07	0.923	0.923	1.52	N/A	N/A	Not installed 2005-2006.
S3650-W100 A-C	S3650 DRIFT-W100	4-254	05/21/07	3.261	3.261	2.29	1.51	52%	
S3650-W100 B-D	S3650 DRIFT-W100	4-254	05/21/07	2.754	2.754	1.99	1.21	64%	

<sup>1</sup> NA indicates insufficient data to compare annualized rates.

**Table 4-1 (Continued)  
Access Drifts Data Analysis**

**JOINT METERS**

Field Tag	Location	Figure Number	Date of Last Reading	Cumulative Displacement (inches)	Dilation Rate 2006 to 2007 (in/year)	Dilation Rate 2005 to 2006 (in/year)	Rate Change Percent	Comments
51X-CG-02703	S1950-E300 Overcast-NE	4-255	06/25/07	0.620	0.017	0.021	-19%	
51X-CG-02706	S1950-E300 Overcast-SW	4-255	06/25/07	1.304	0.081	0.072	13%	
51X-CG-02707	S1950-E300 Overcast-NW	4-255	06/25/07	1.334	0.085	0.076	12%	
51X-CG-02708	S1950-E300 Overcast-SE	4-255	06/25/07	0.695	0.024	0.029	-17%	

**ROCKBOLT LOAD CELLS**

Field Tag	Location	Figure Number	Date of Initial Reading	Date of Last Reading	Load (kips)	Comments
51X-WG-00221	S1300 DRIFT-E120	4-256	10/23/96	06/25/07	1.4	
51X-WG-00222	S1300 DRIFT-E160	4-256	10/23/96	06/25/07	38.9	
51X-WG-00293	E140 DRIFT-S1550	4-257	03/17/04	06/28/07	61.6	
51X-WG-00223	S1600 DRIFT-E150	4-258	02/18/96	06/25/07	21.4	
51X-WG-00224	S1600 DRIFT-E130	4-258	02/18/96	06/25/07	0.0	Rockbolt failed.
51X-WG-00294	E140 DRIFT-S1775	4-259	03/17/04	06/28/07	40.9	
51X-WG-00295	E140 DRIFT-S2900	4-260	03/31/04	06/06/07	51.6	
51X-WG-00296	E140 DRIFT-S2900	4-260	03/31/04	01/16/07	58.8	

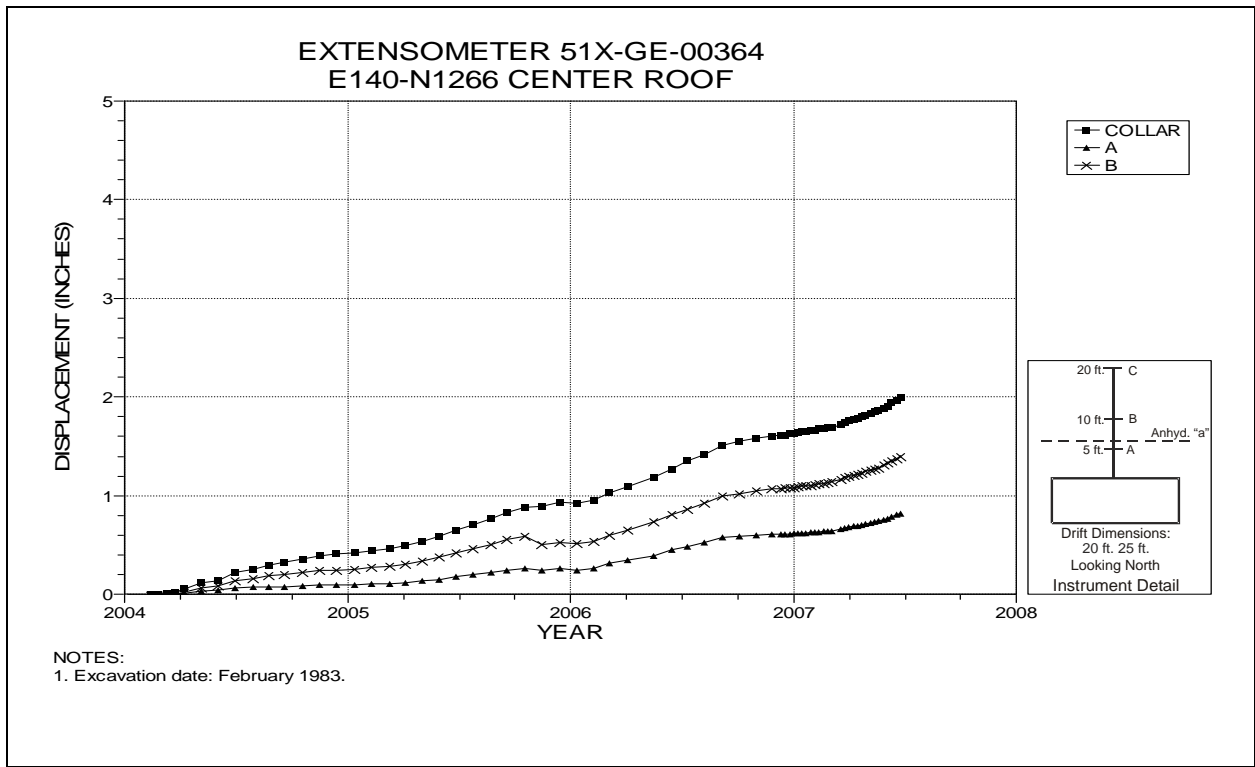


Figure 4-1 Extensometer 51X-GE-00364  
E140 Drift at N1266 – Roof

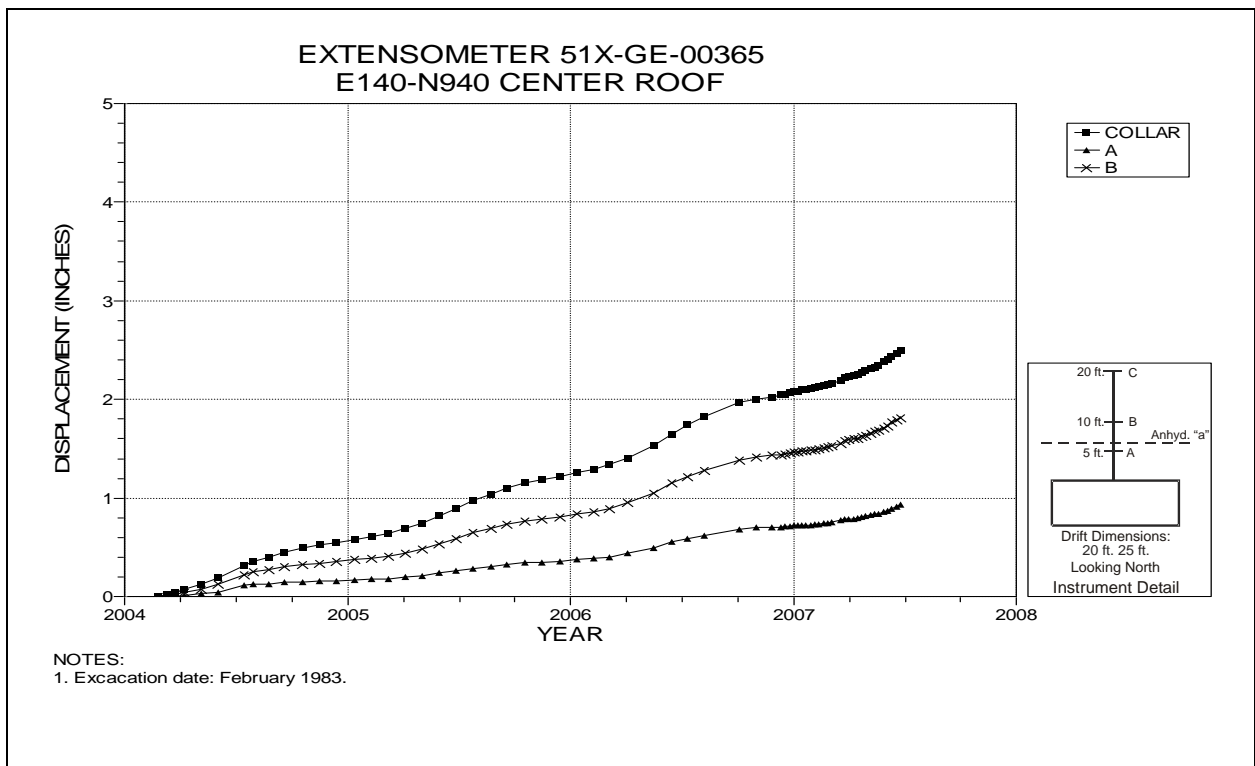


Figure 4-2 Extensometer 51X-GE-00365  
E140 Drift at N940 – Roof

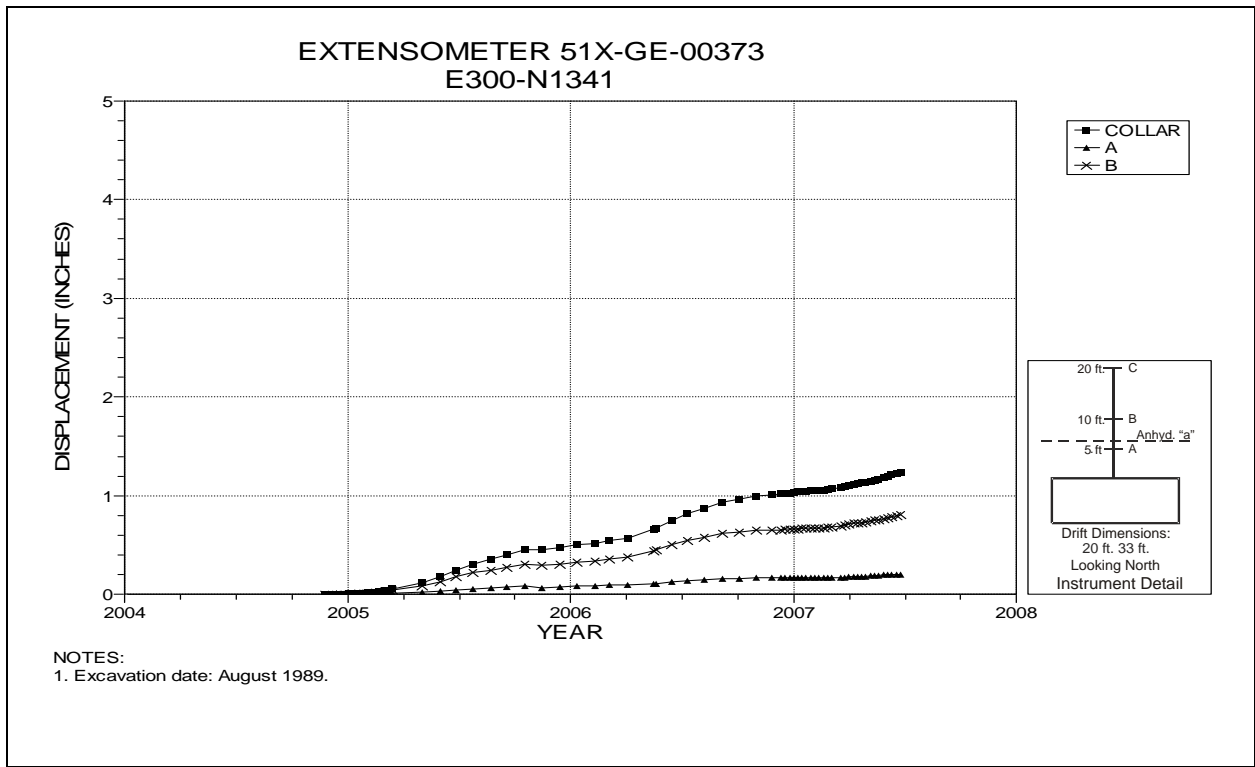


Figure 4-3 Extensometer 51X-GE-00373  
E300 Drift at N1341 – Roof

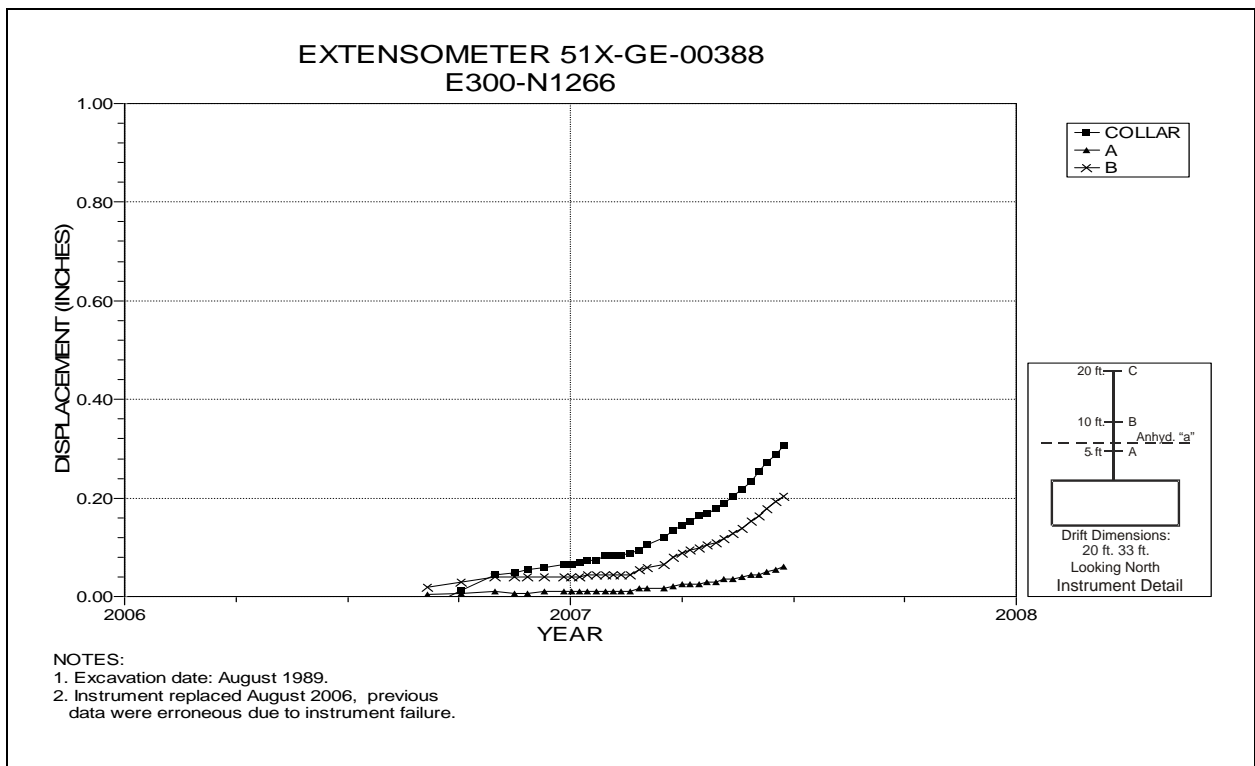


Figure 4-4 Extensometer 51X-GE-00388  
E300-Drift at N1266 – Roof

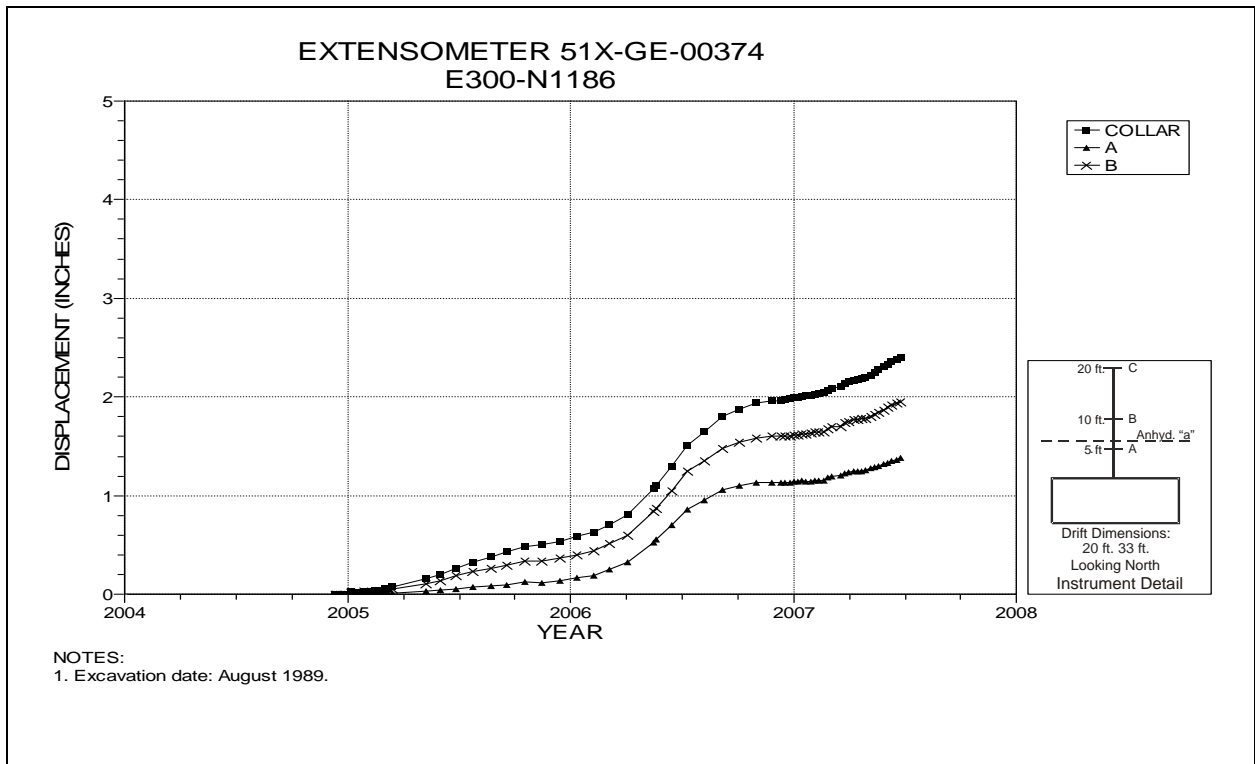


Figure 4-5 Extensometer 51X-GE-00374  
E300 Drift at N1186 – Roof

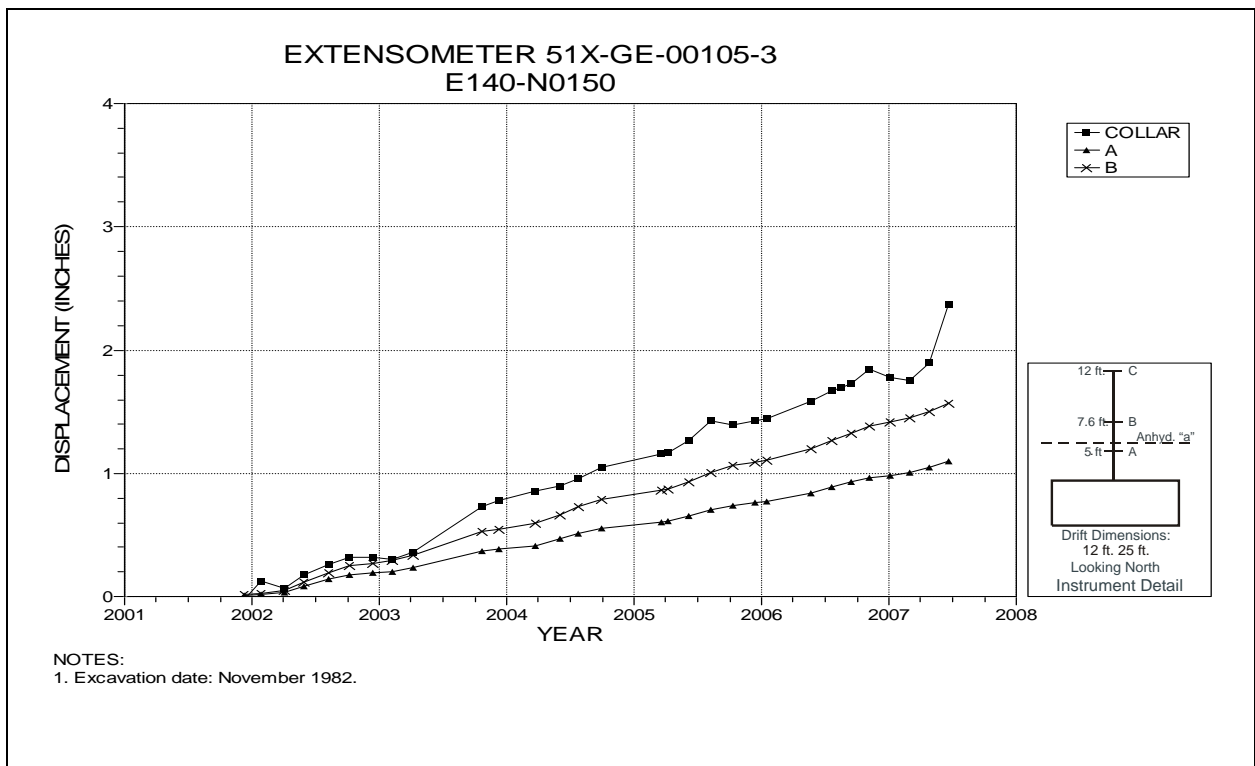


Figure 4-6 Extensometer 51X-GE-00105-3  
E140 at N150 – Roof

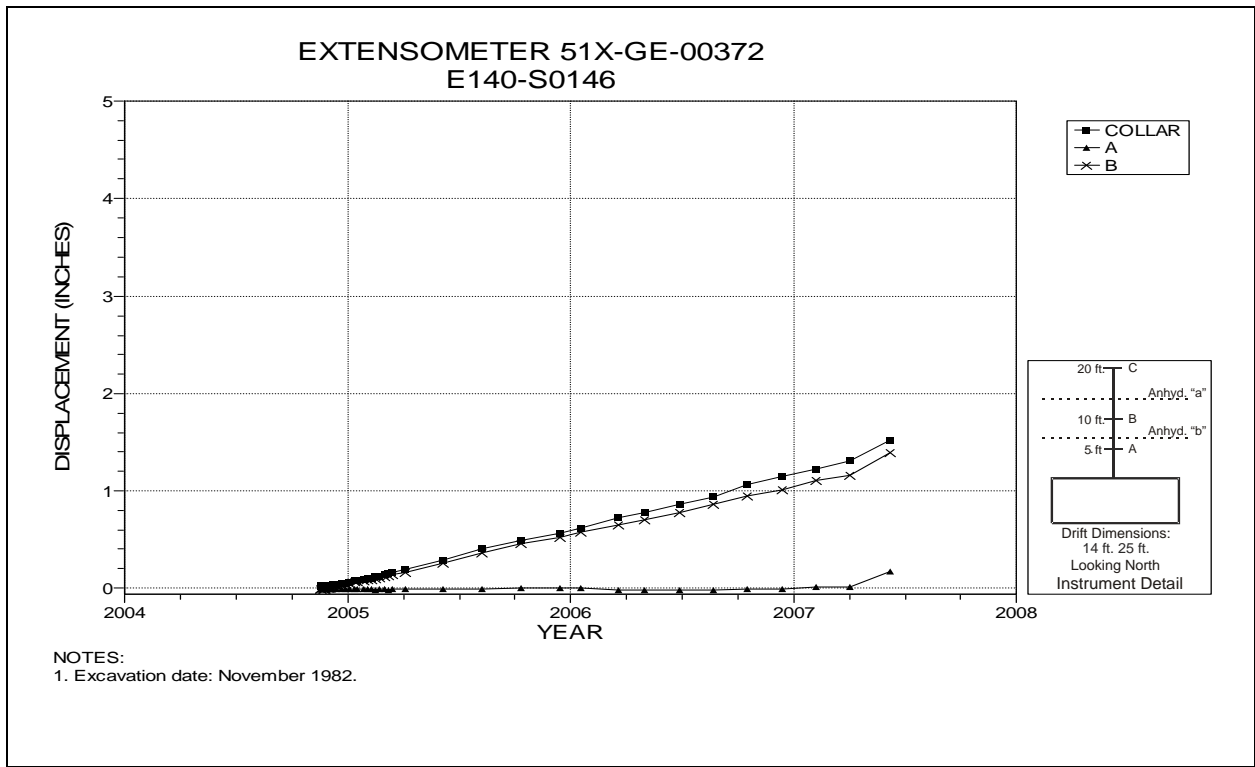


Figure 4-7 Extensometer 51X-GE-00372  
E140 Drift at S146 – Roof

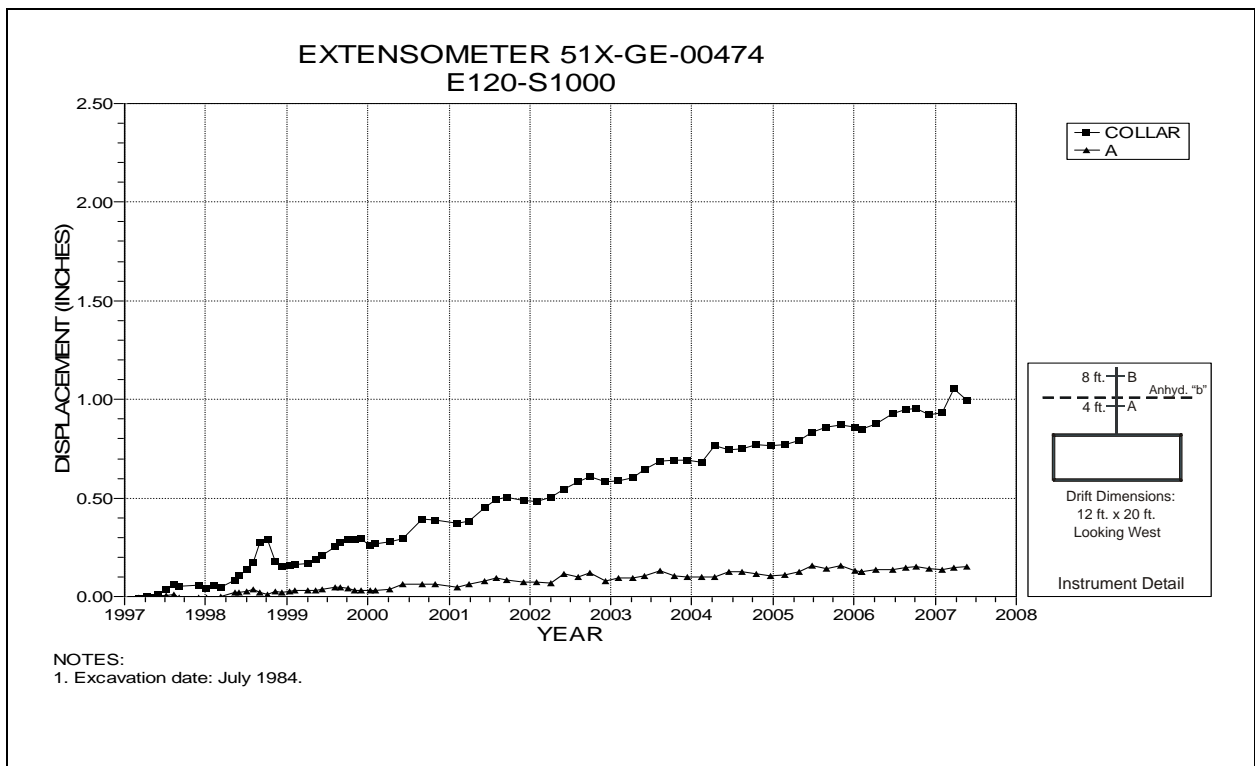


Figure 4-8 Extensometer 51X-GE-00474  
S1000 Drift at E120 – Roof



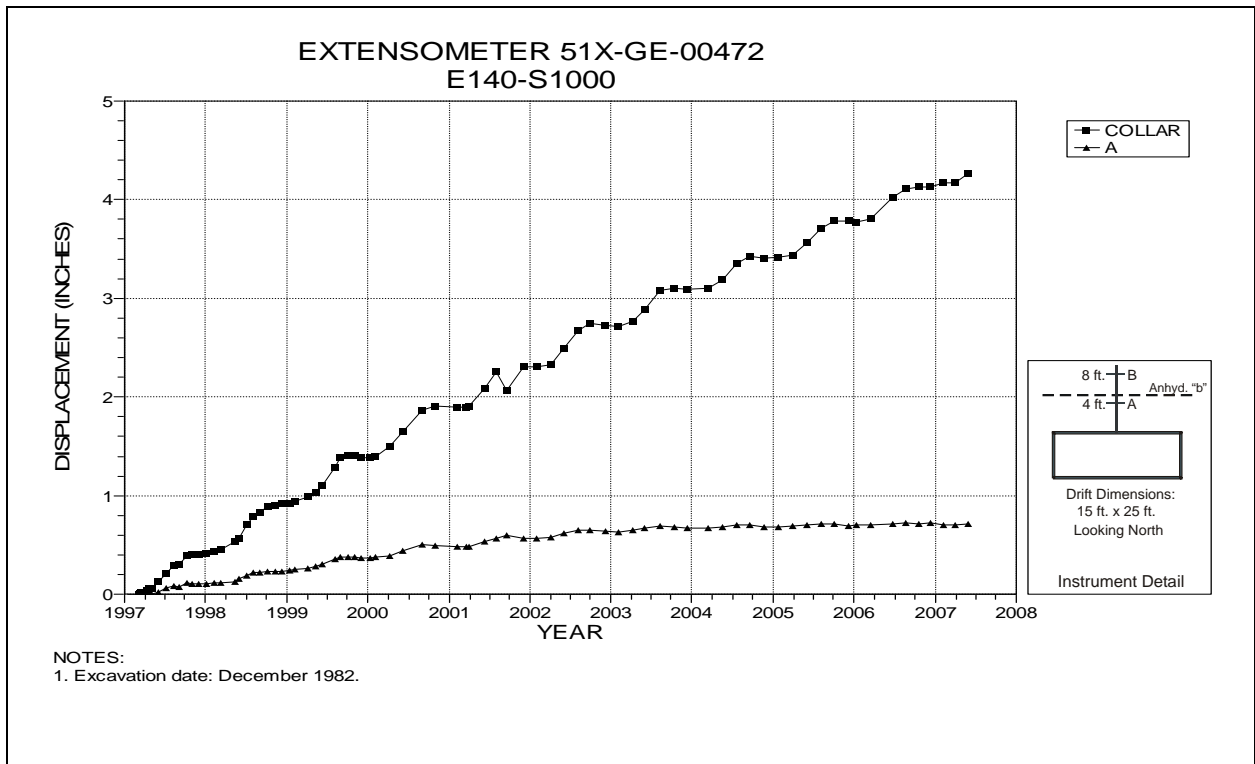


Figure 4-9 Extensometer 51X-GE-00472  
E140 Drift at S1000 – Roof

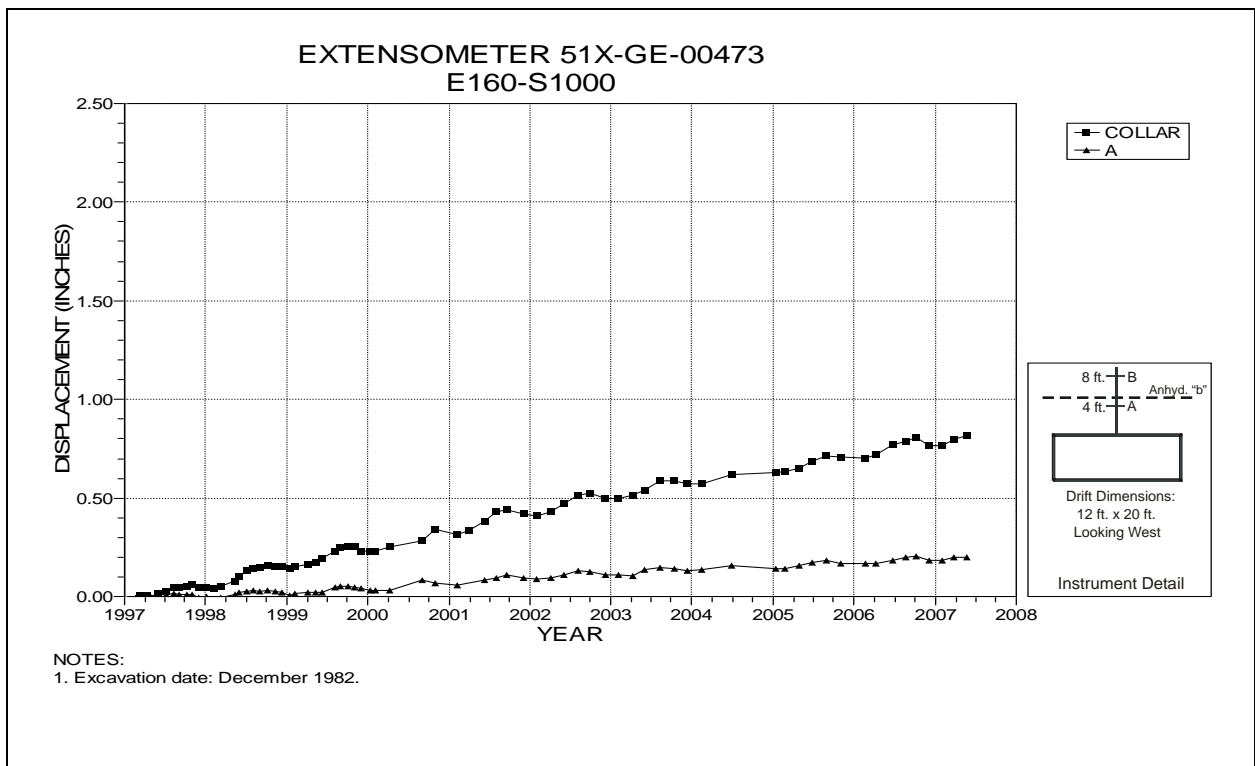


Figure 4-10 Extensometer 51X-GE-00473  
S1000 Drift at E160 – Roof

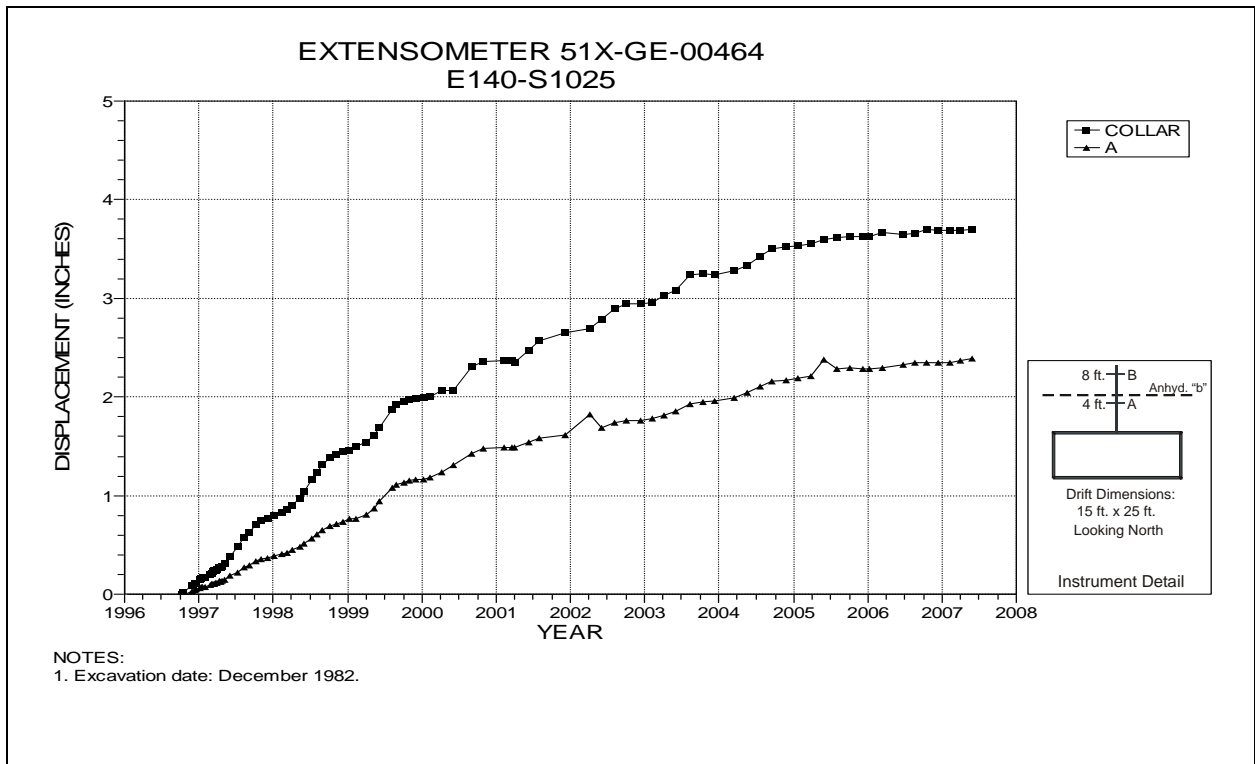


Figure 4-11 Extensometer 51X-GE-00464  
E140 Drift at S1025 – Roof

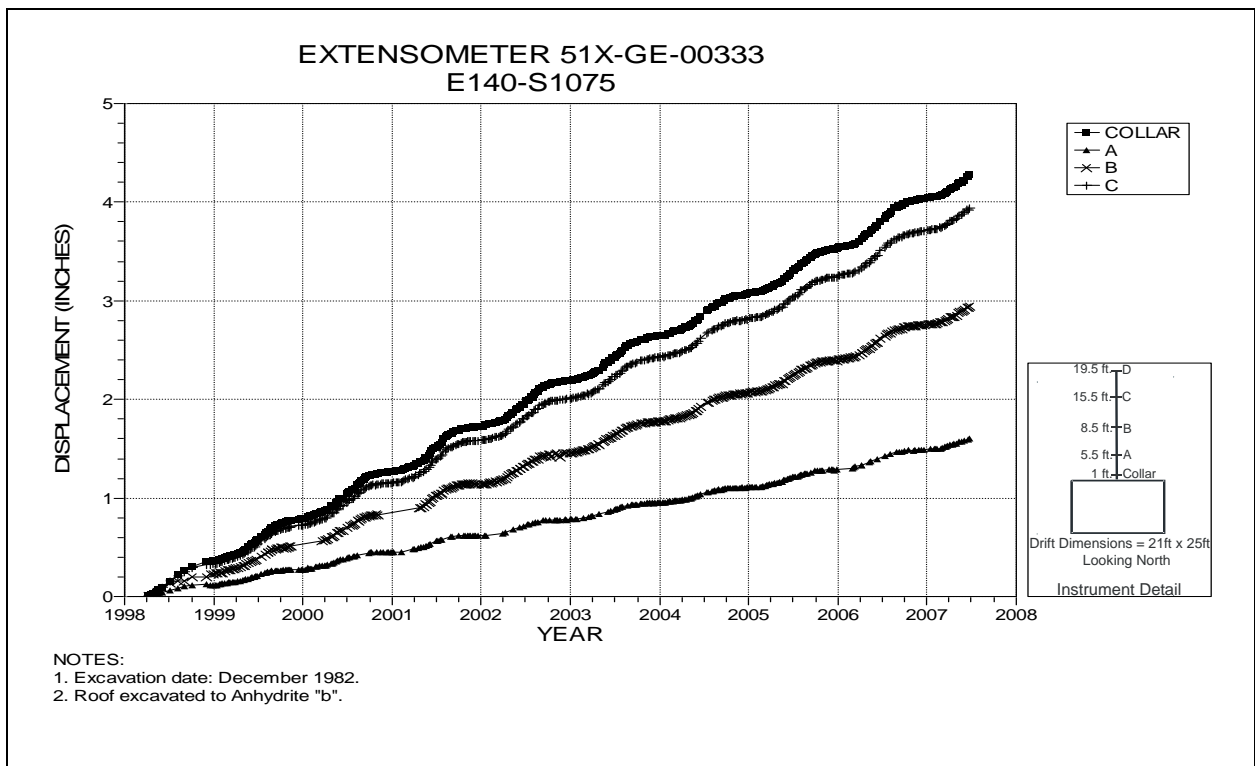


Figure 4-12 Extensometer 51X-GE-00333  
E140 Drift at S1075 – Roof

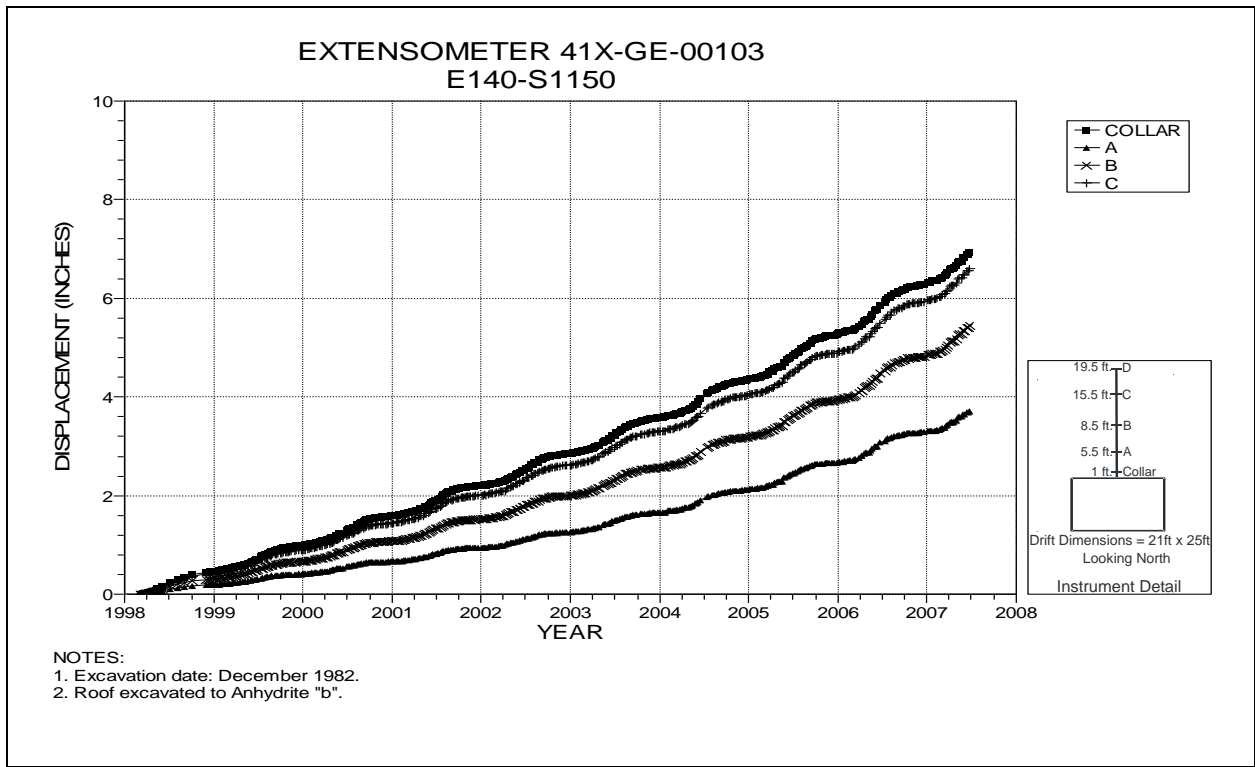


Figure 4-13 Extensometer 41X-GE-00103  
E140 at S1150 – Roof

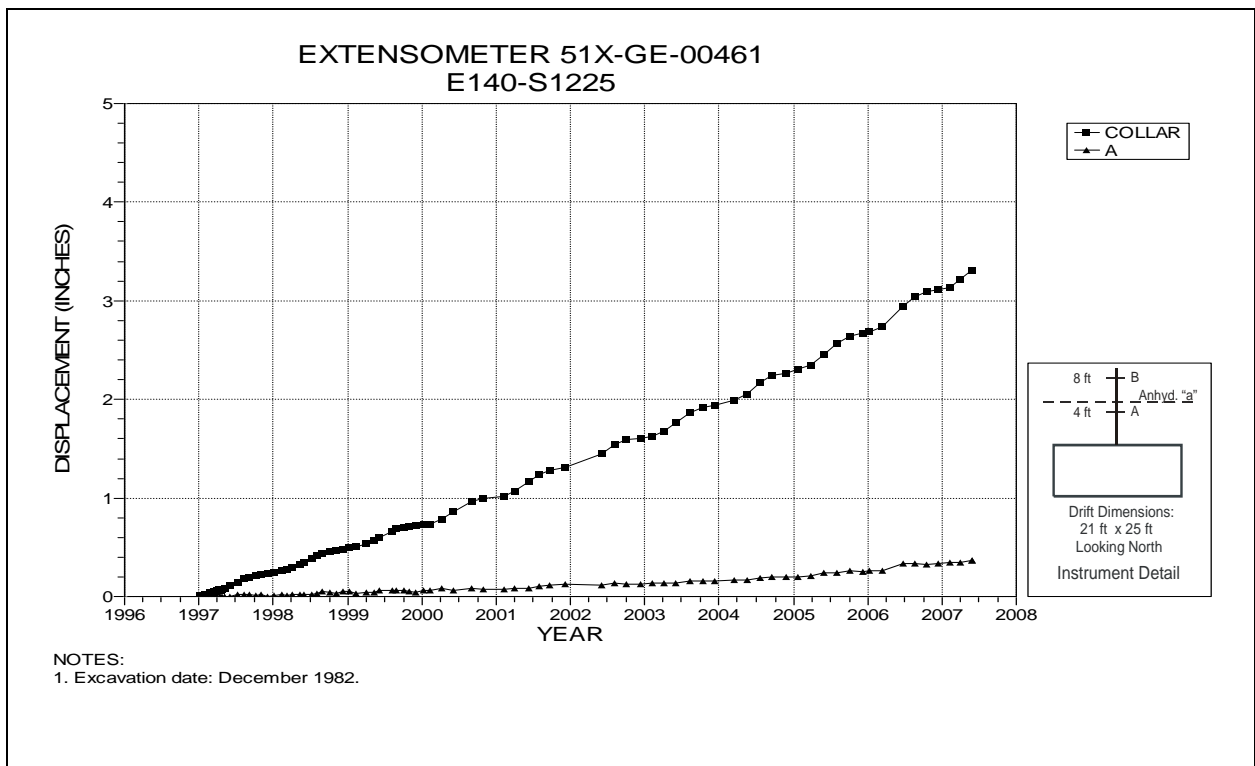


Figure 4-14 Extensometer 51X-GE-00461  
E140 Drift at S1225 – Roof

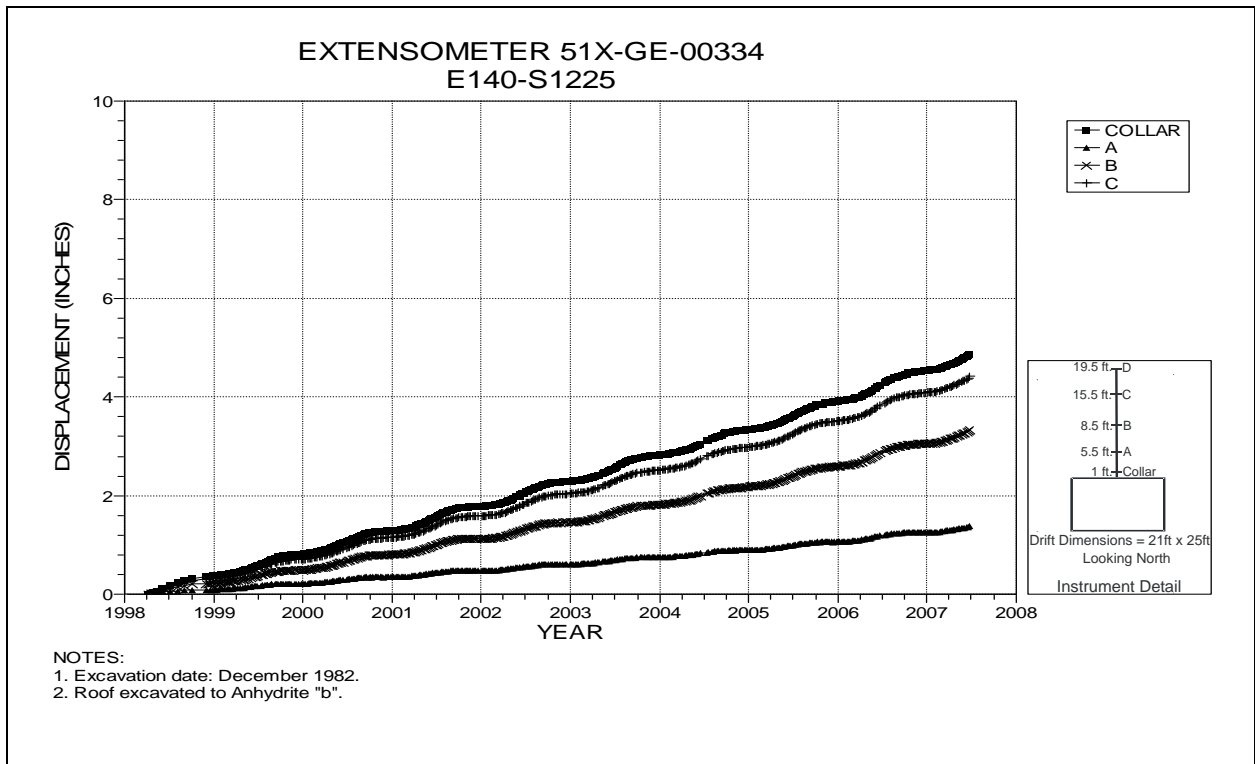


Figure 4-15 Extensometer 51X-GE-00334  
E140 Drift at S1225 – Roof

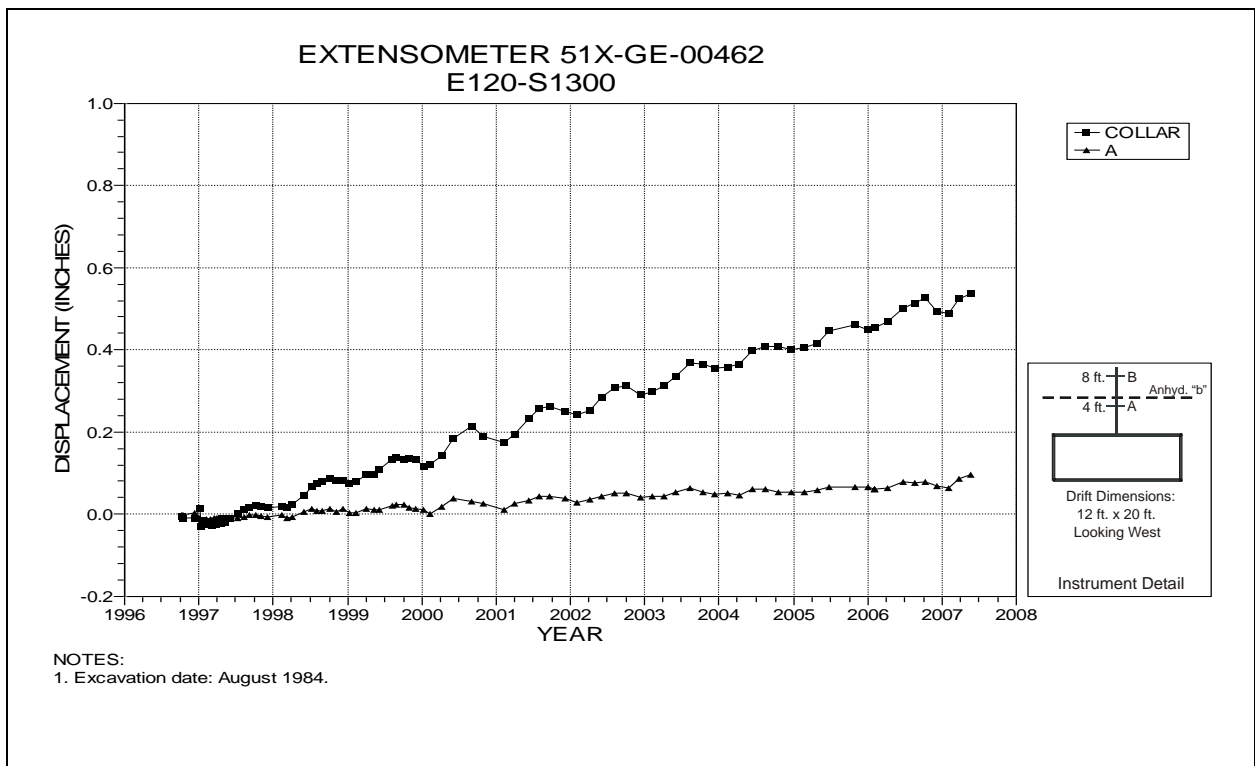


Figure 4-16 Extensometer 51X-GE-00462  
E120 at S1300 – Roof

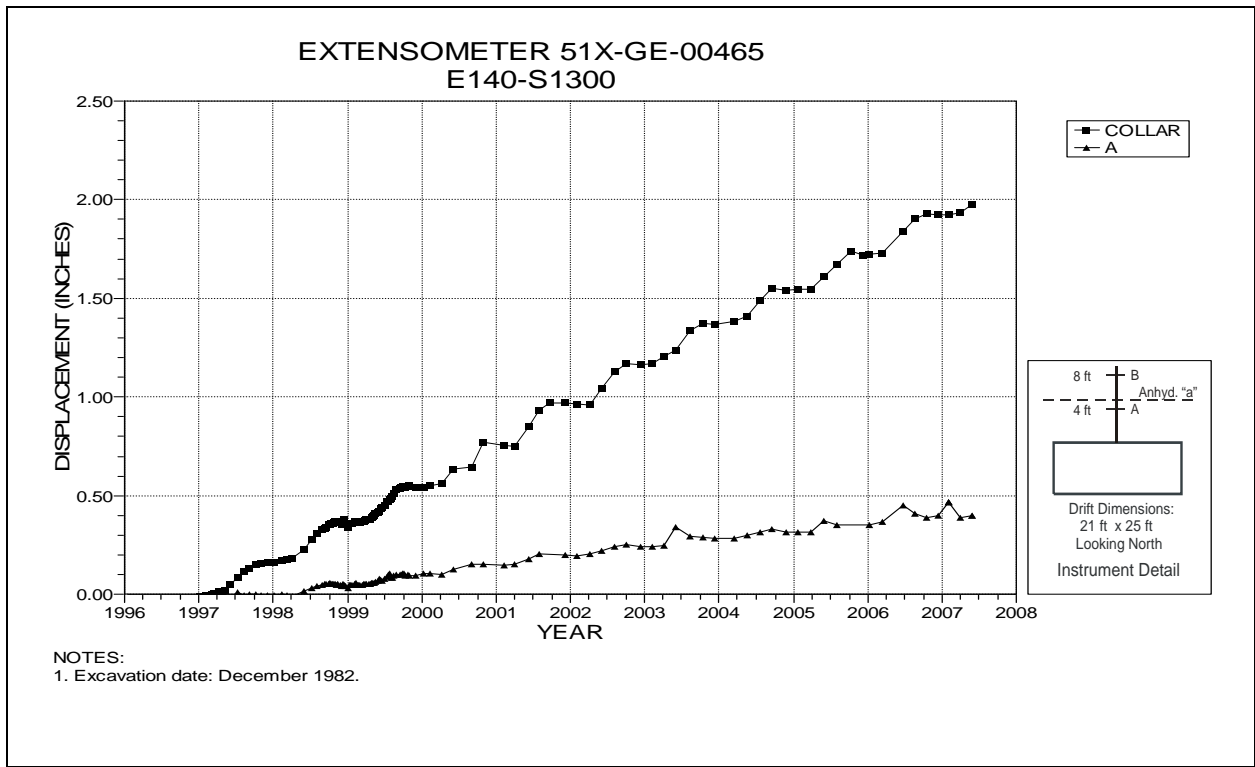


Figure 4-17 Extensometer 51X-GE-00465  
E140 Drift at S1300 – Roof

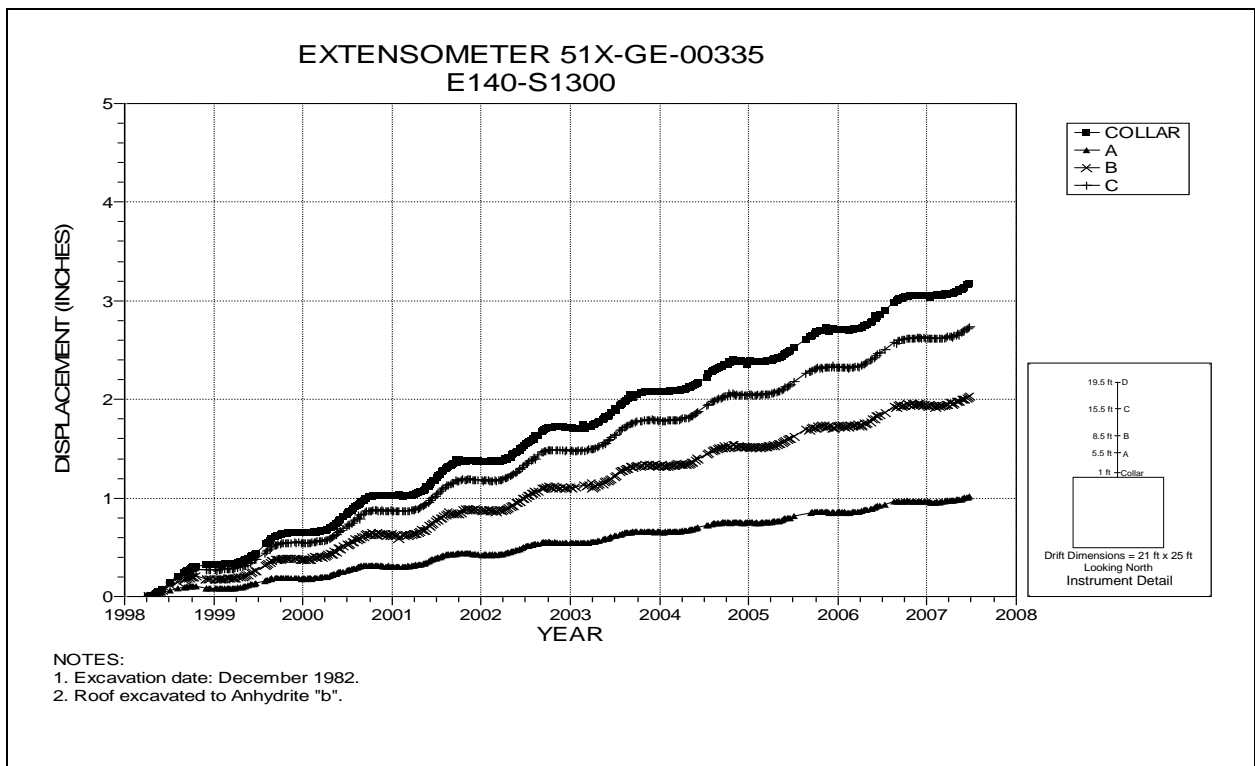


Figure 4-18 Extensometer 51X-GE-00335  
E140 Drift at S1300 – Roof

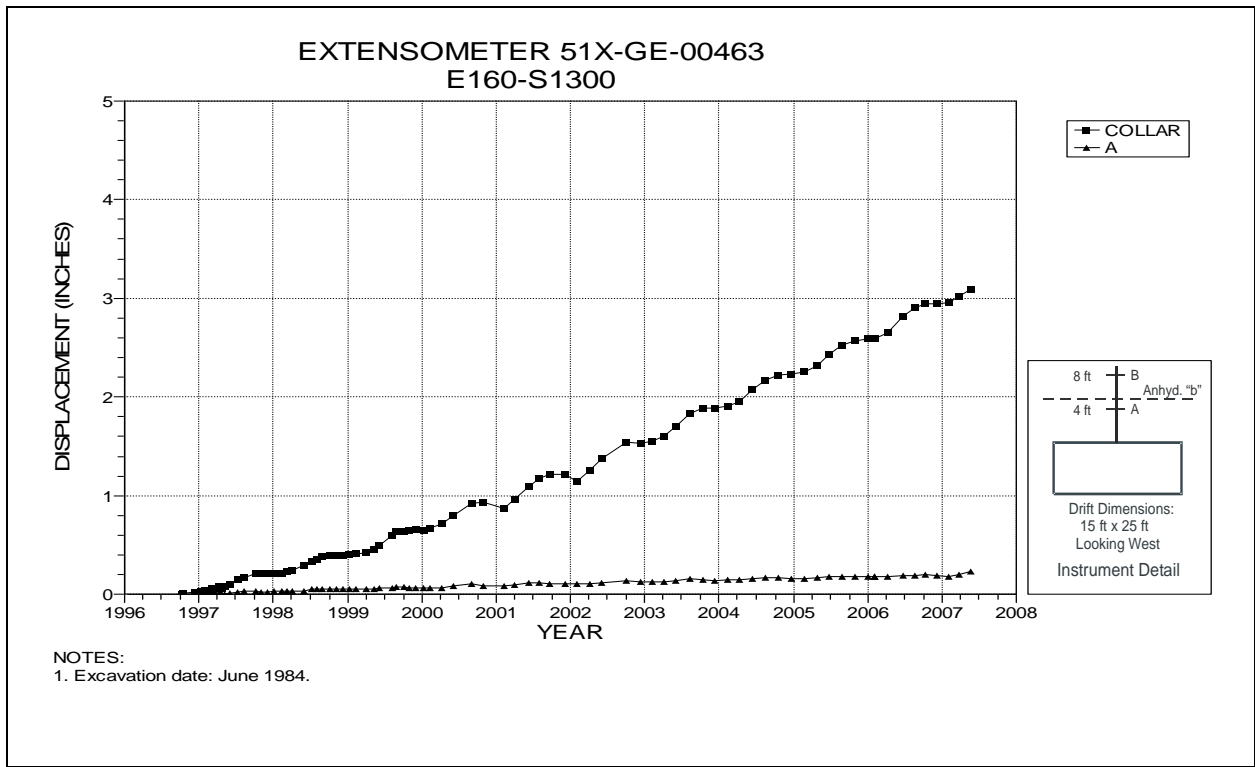


Figure 4-19 Extensometer 51X-GE-00463  
S1300 Drift at E160 – Roof

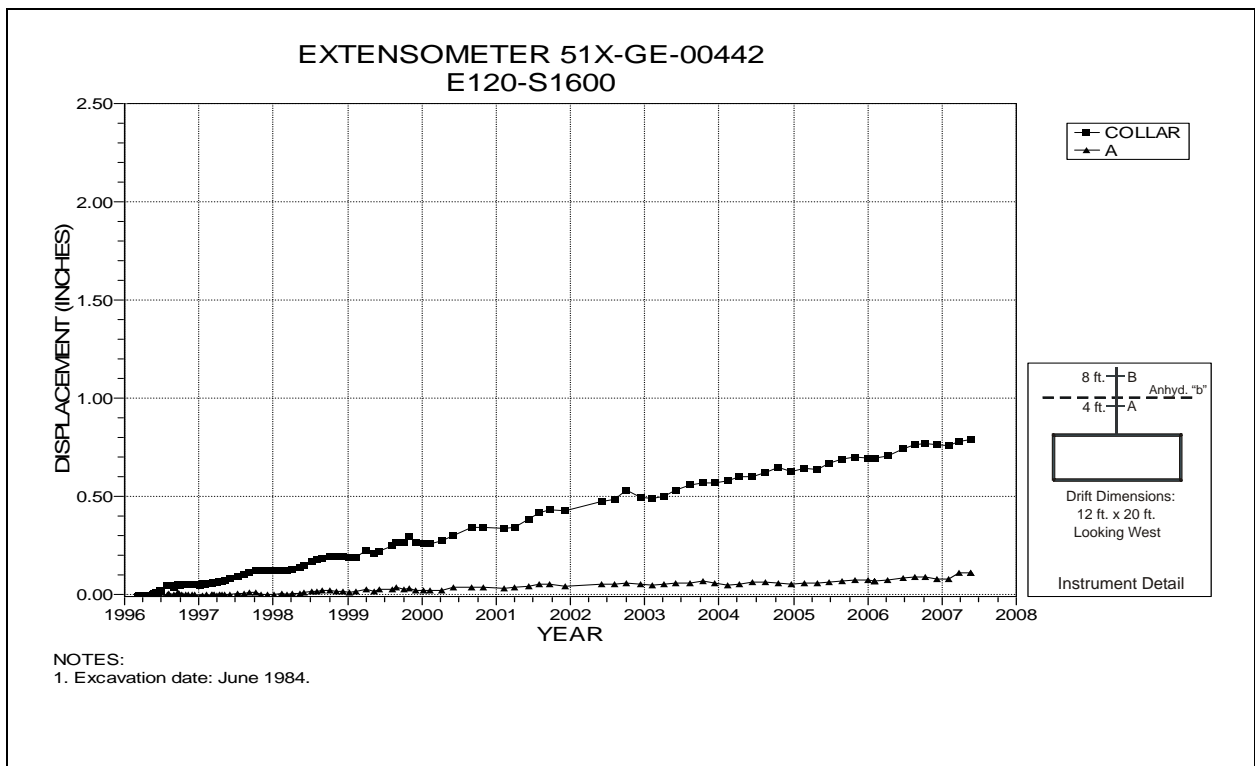


Figure 4-20 Extensometer 51X-GE-00442  
S1600 Drift at E120 – Roof

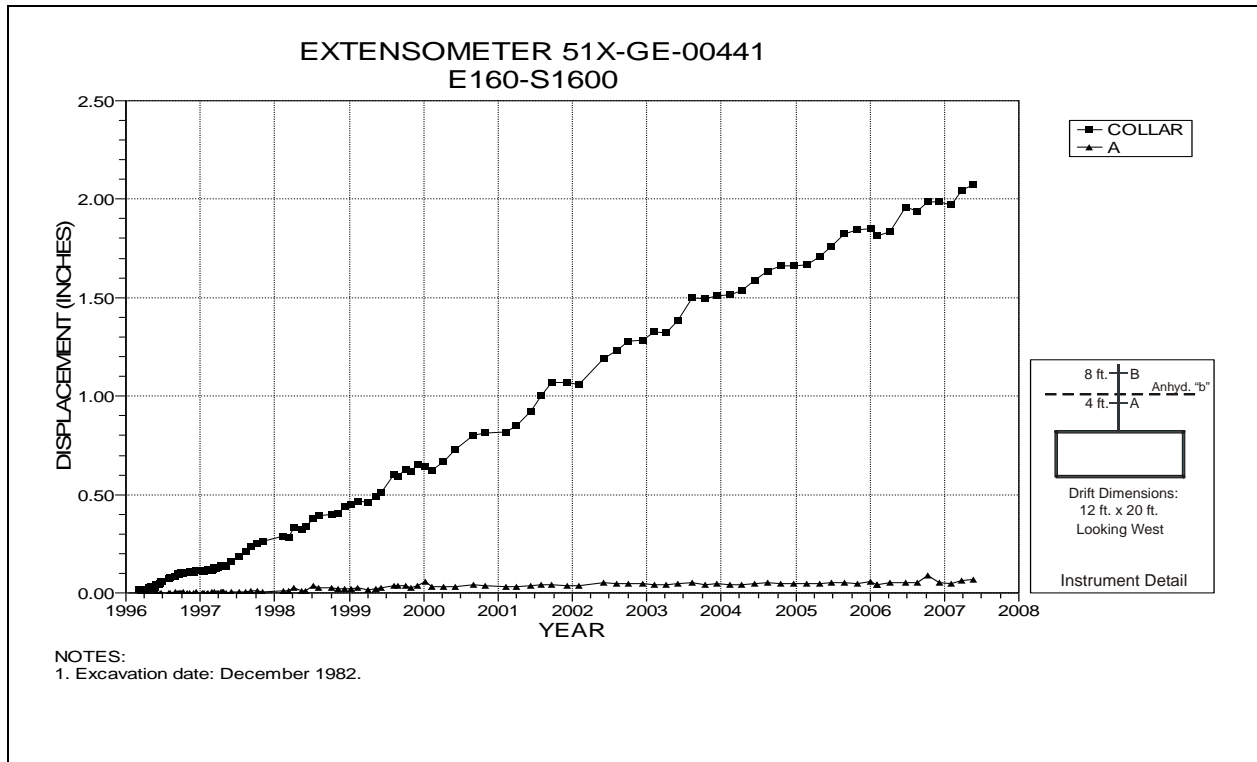


Figure 4-21 Extensometer 51X-GE-00441  
S1600 Drift at E160 – Roof

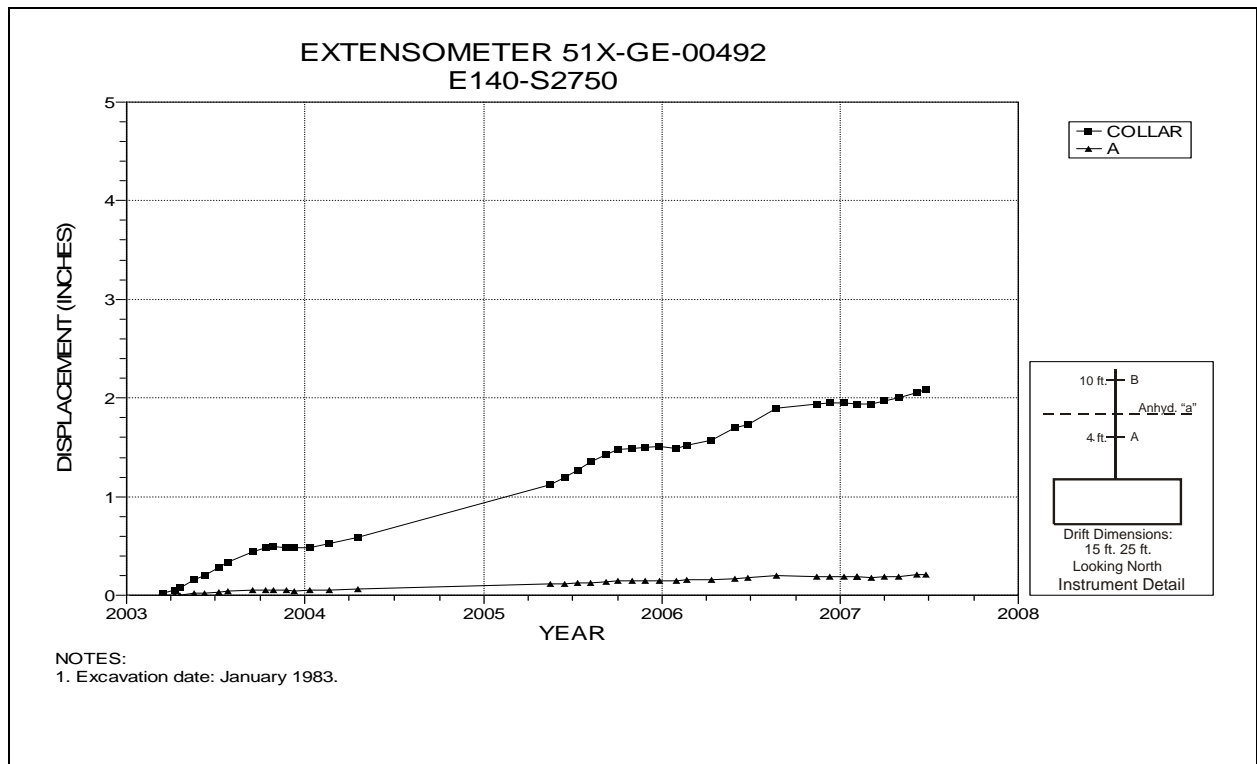


Figure 4-22 Extensometer 51X-GE-00492  
E140 Drift Intersection at S2750 – Roof

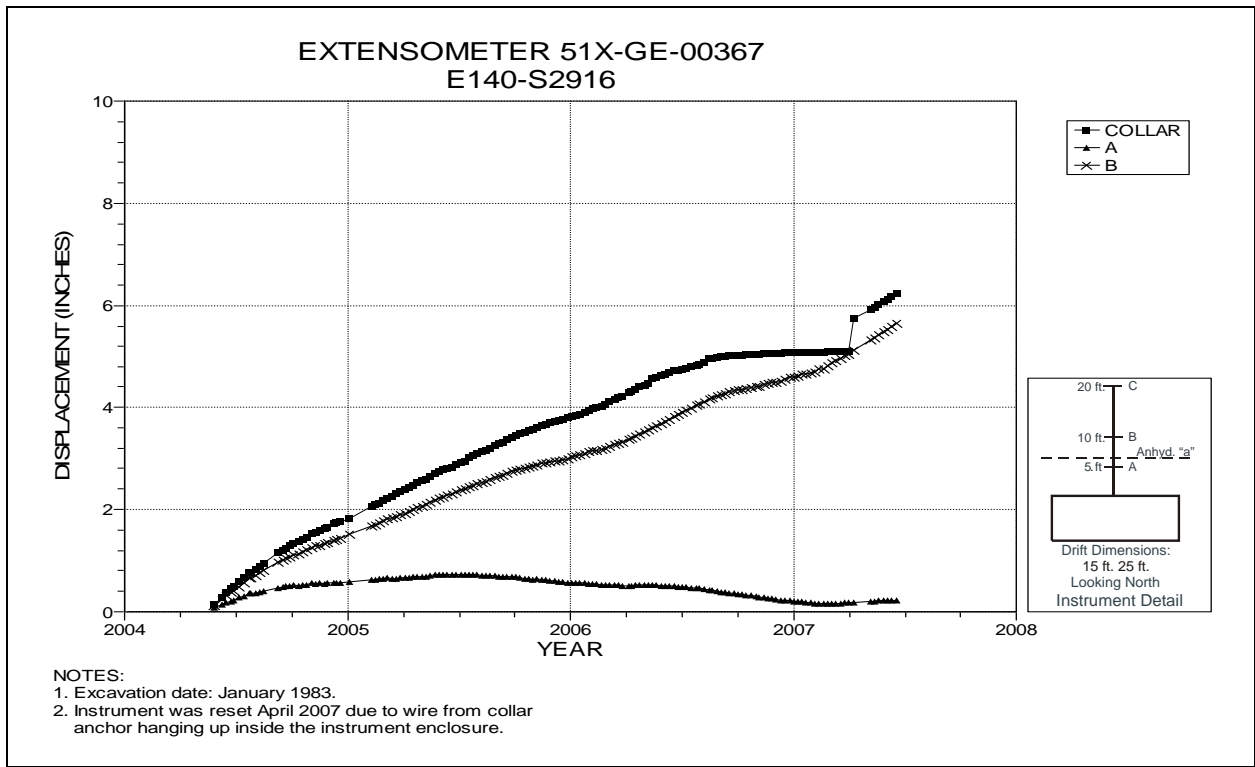


Figure 4-23 Extensometer 51X-GE-00367  
E140 Drift at S2916 – Roof

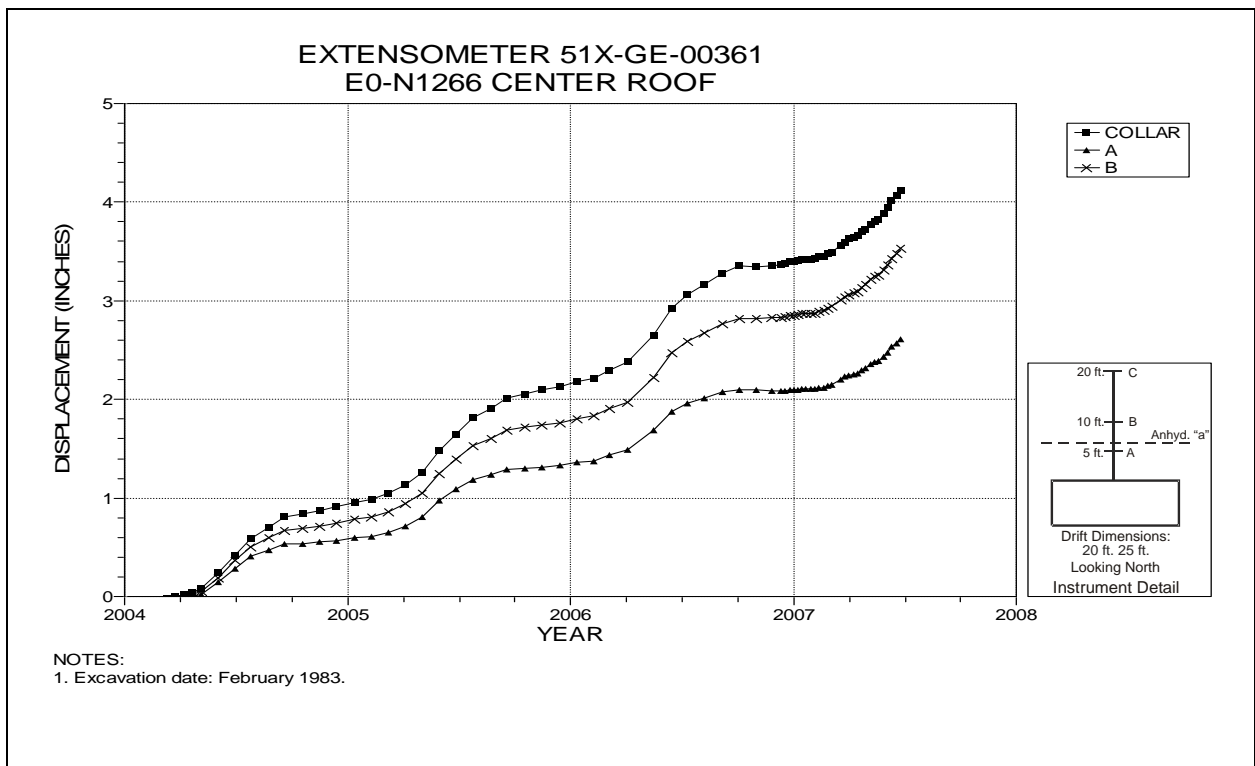


Figure 4-24 Extensometer 51X-GE-00361  
E0 Drift at N1266 – Roof



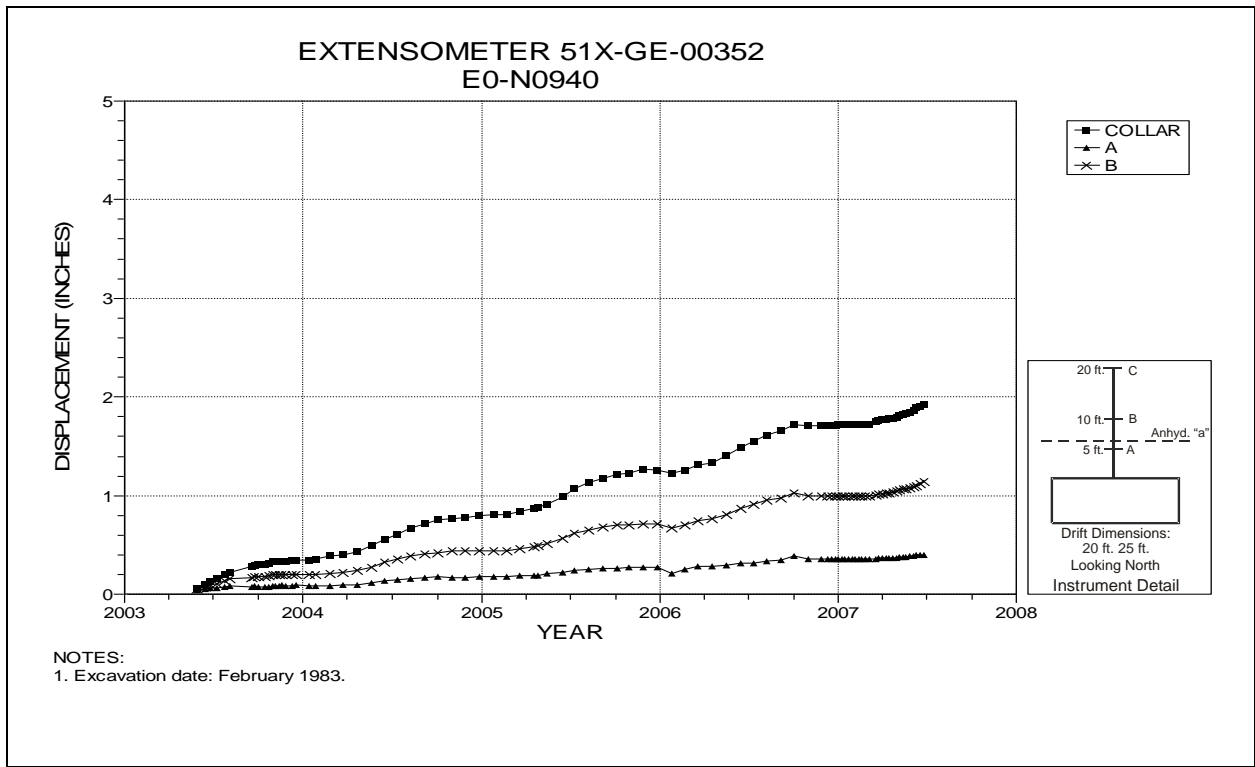


Figure 4-25 Extensometer 51X-GE-00352  
E0 Drift at N940 – Roof

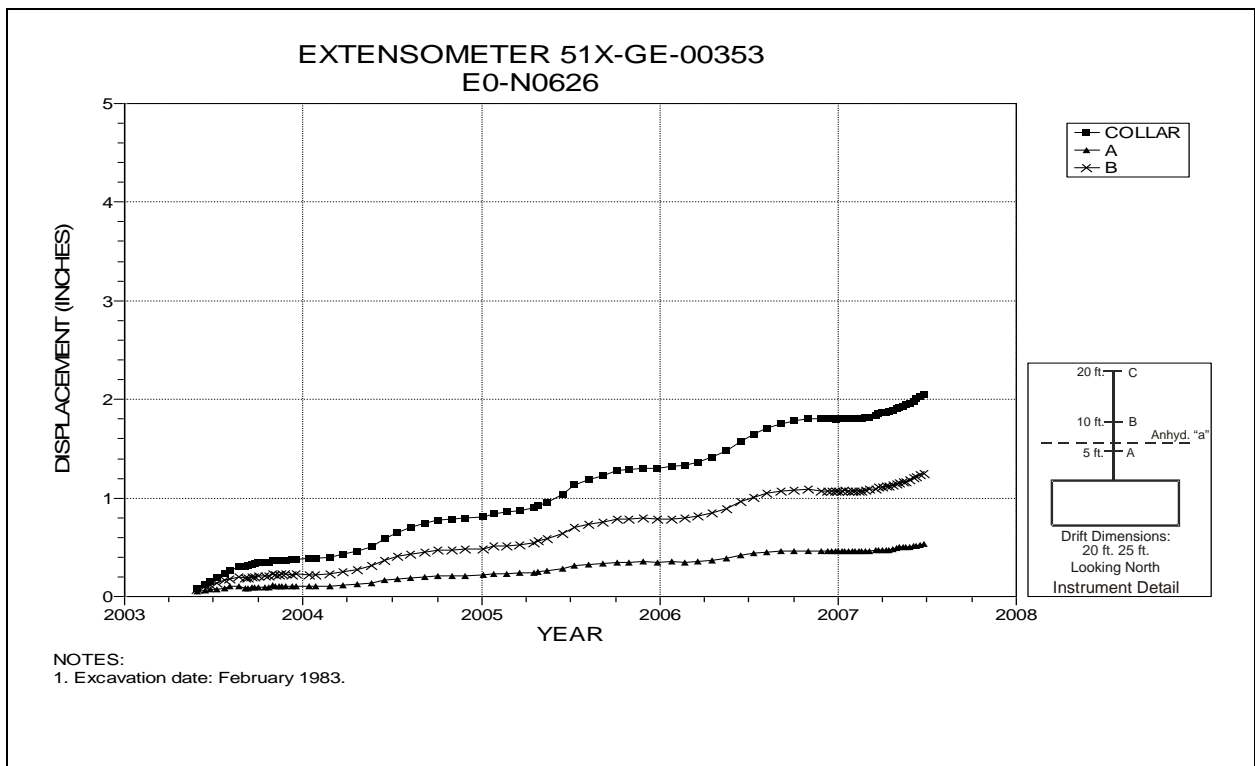


Figure 4-26 Extensometer 51X-GE-00353  
E0 Drift at N626 – Roof

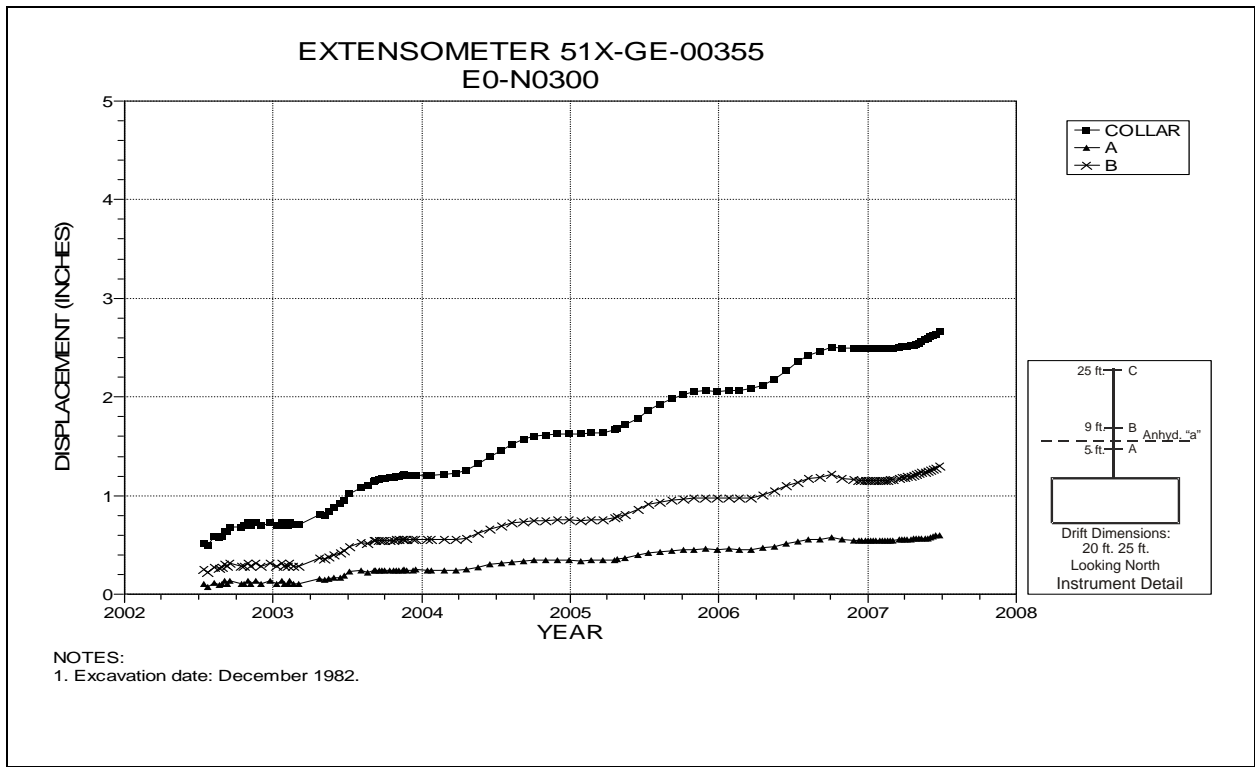


Figure 4-27 Extensometer 51X-GE-00355  
E0 Drift at N300 – Roof

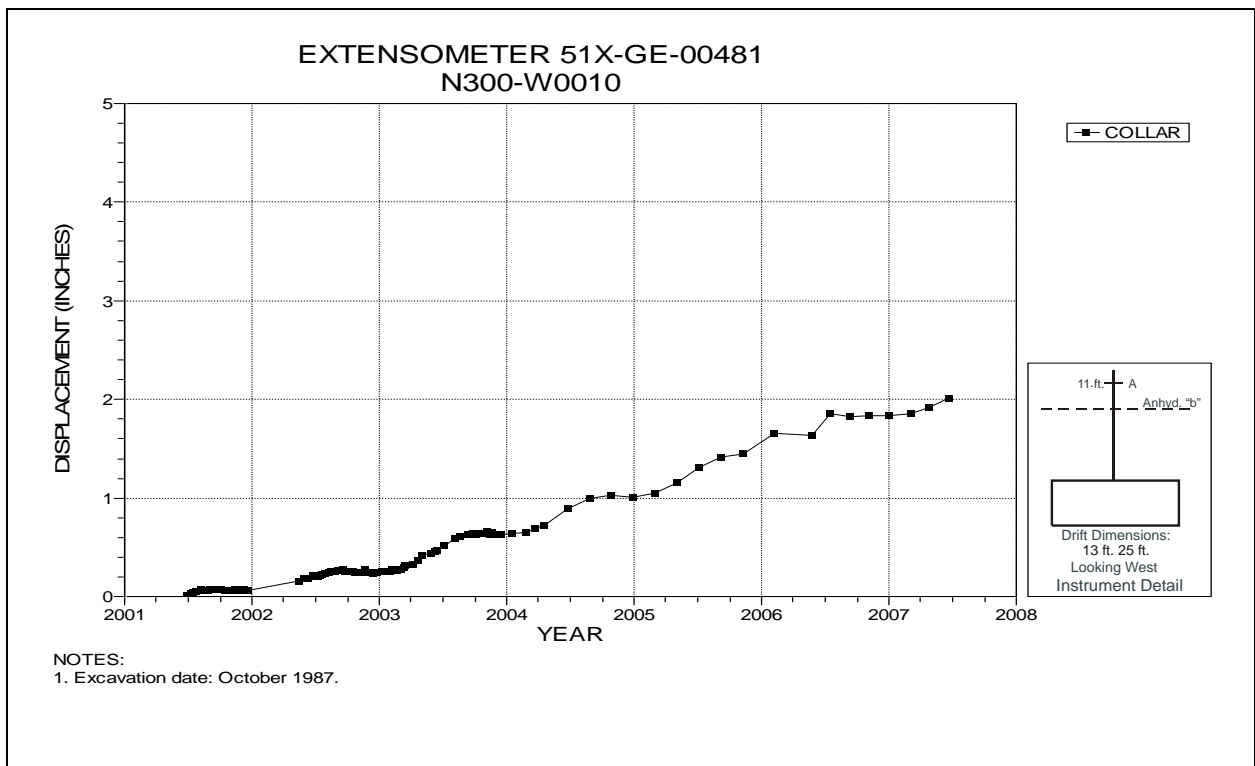


Figure 4-28 Extensometer 51X-GE-00481  
N300 Drift at W10 – Roof

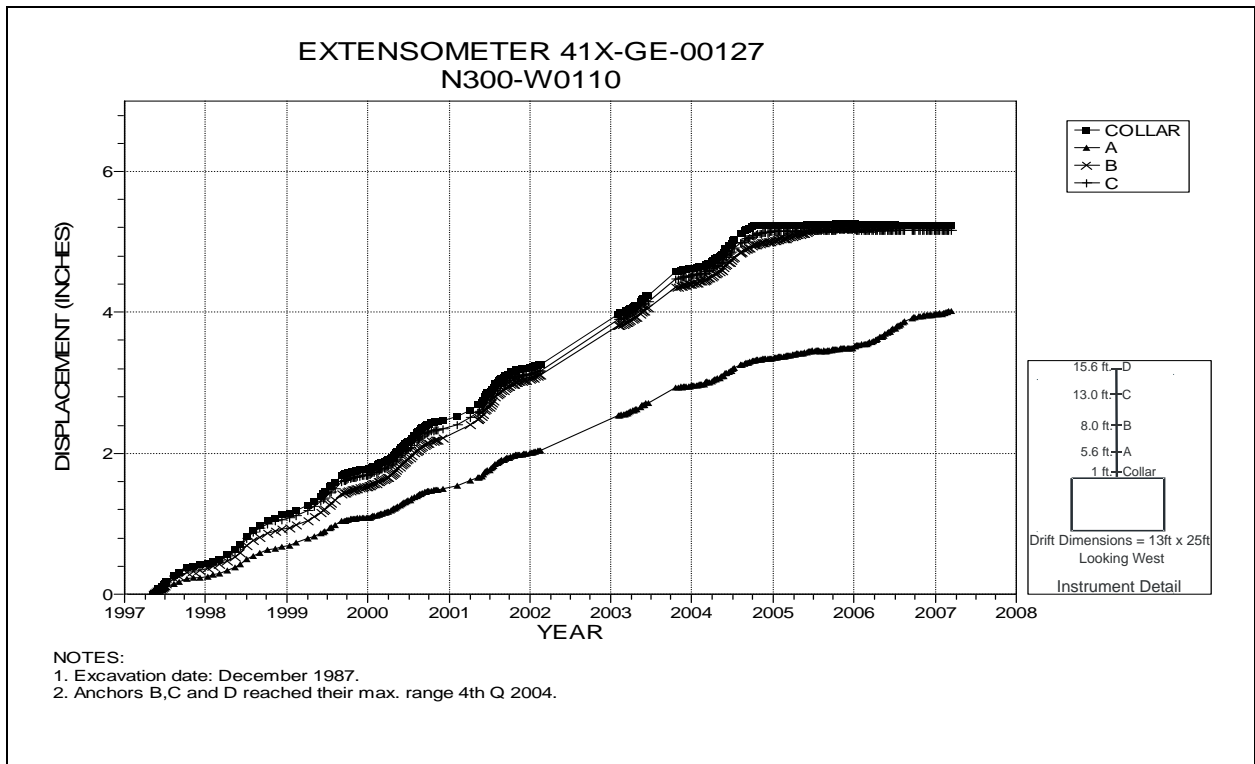


Figure 4-29 Extensometer 41X-GE-00127  
N300 Drift at W110 – Roof

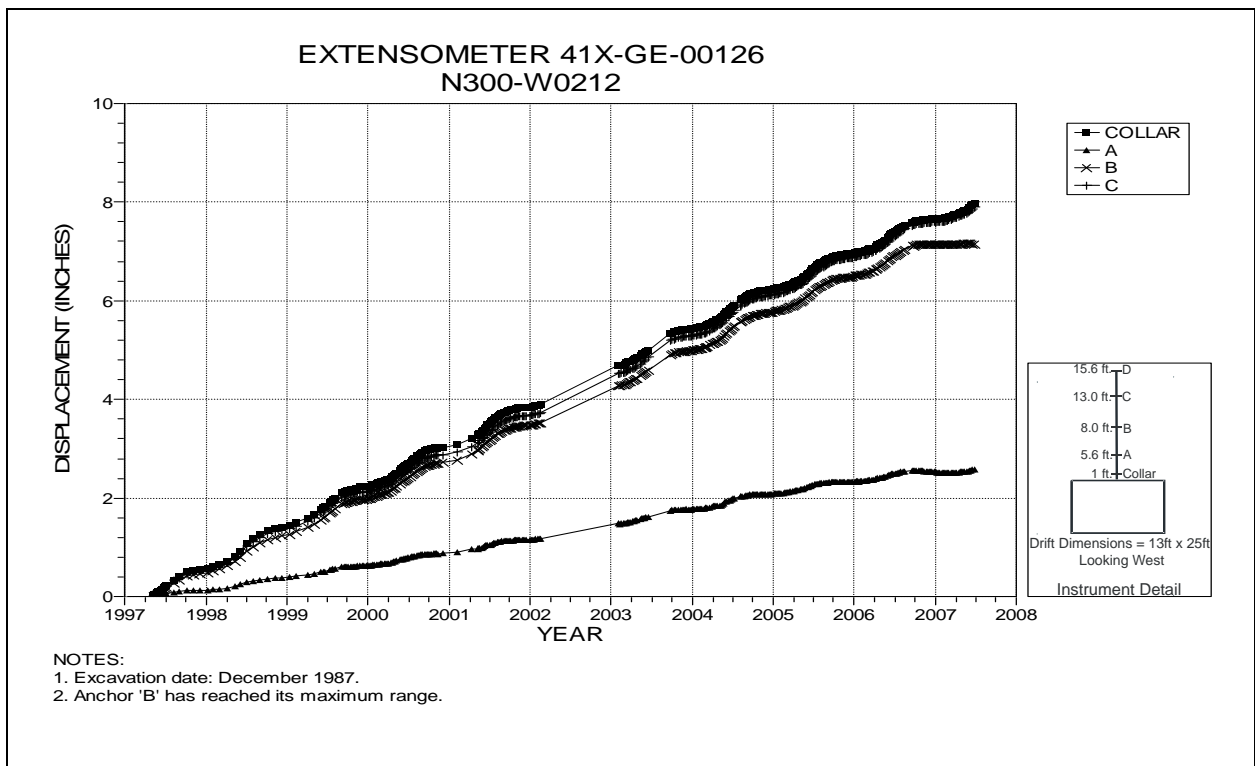


Figure 4-30 Extensometer 41X-GE-00126  
N300 Drift at W212 – Roof

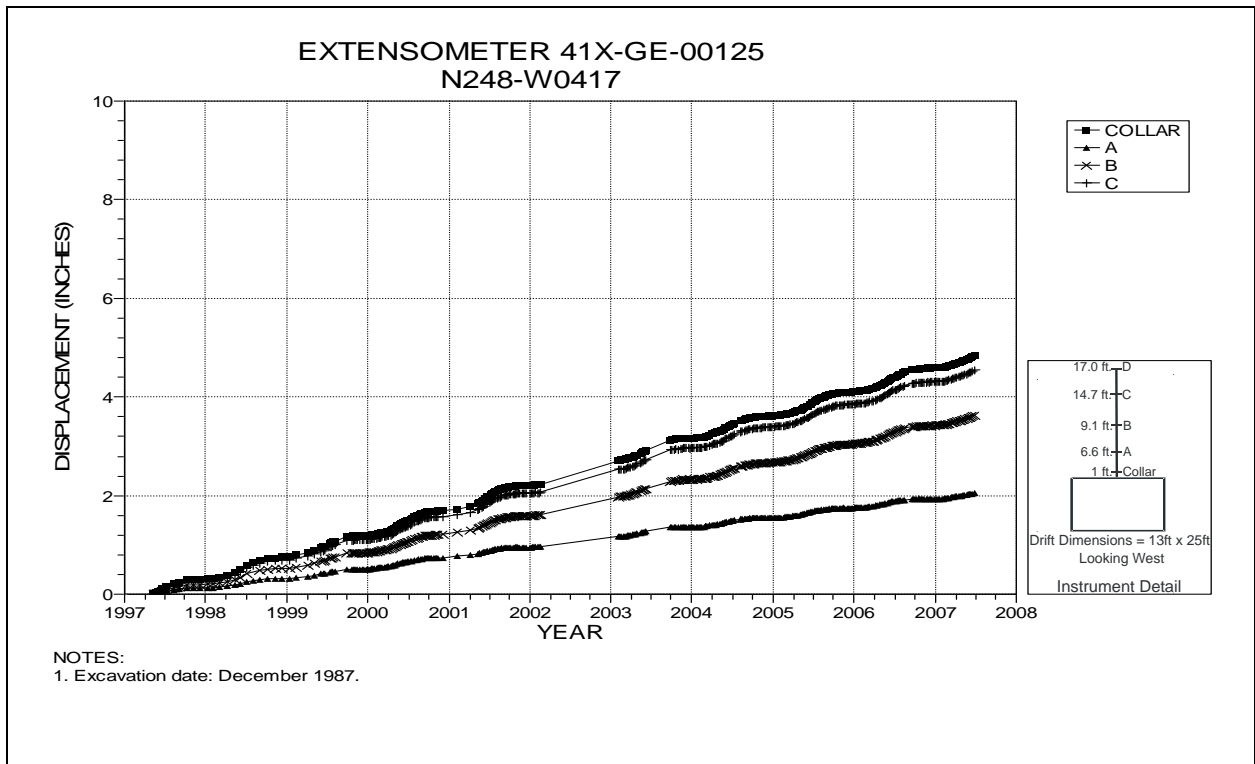


Figure 4-31 Extensometer 41X-GE-00125  
N248 Drift at W417 – Roof

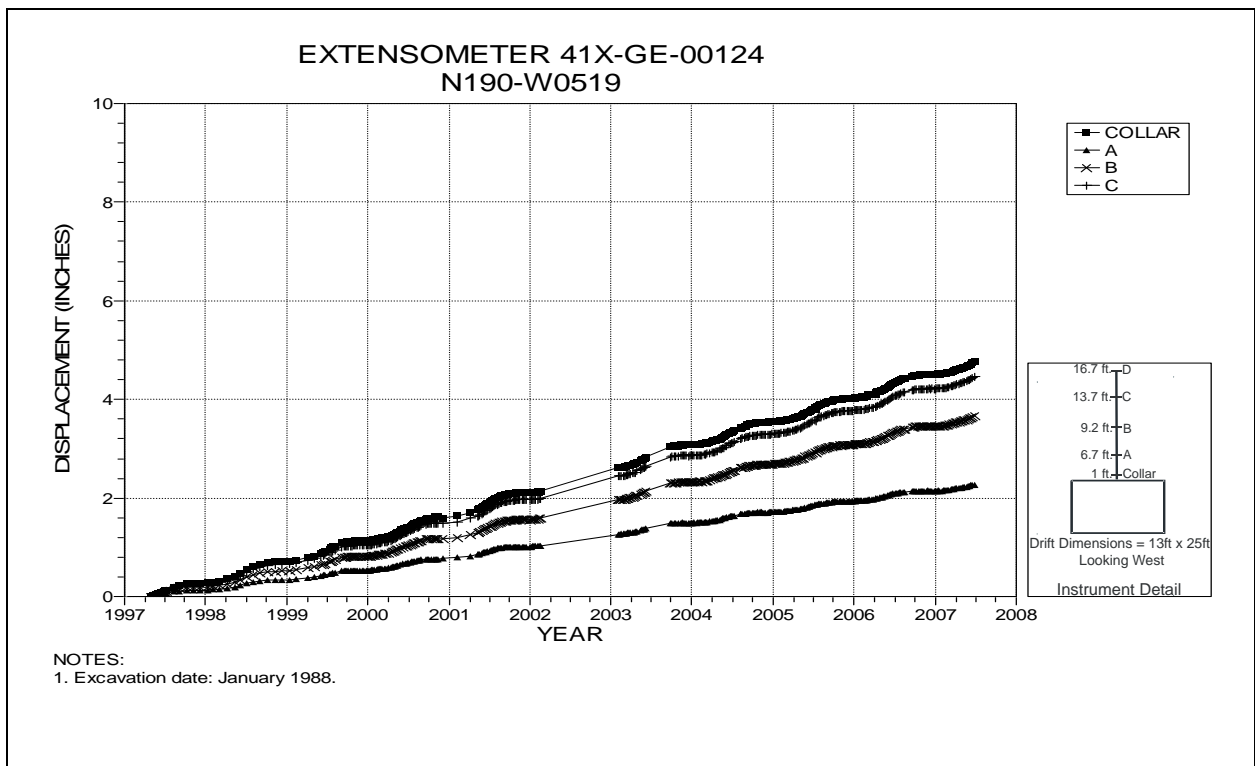


Figure 4-32 Extensometer 41X-GE-00124  
N190 Drift at W519 – Roof

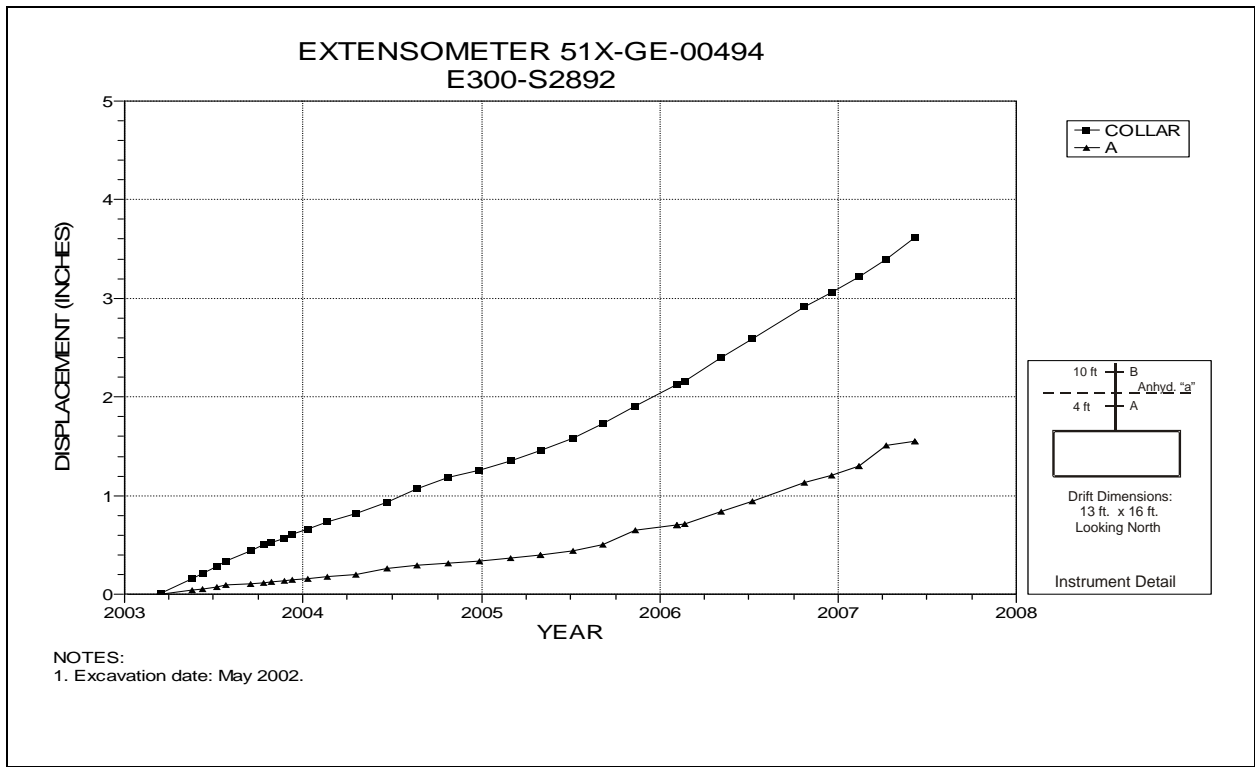


Figure 4-33 Extensometer 51X-GE-00494  
E300 Drift at S2892 – Roof

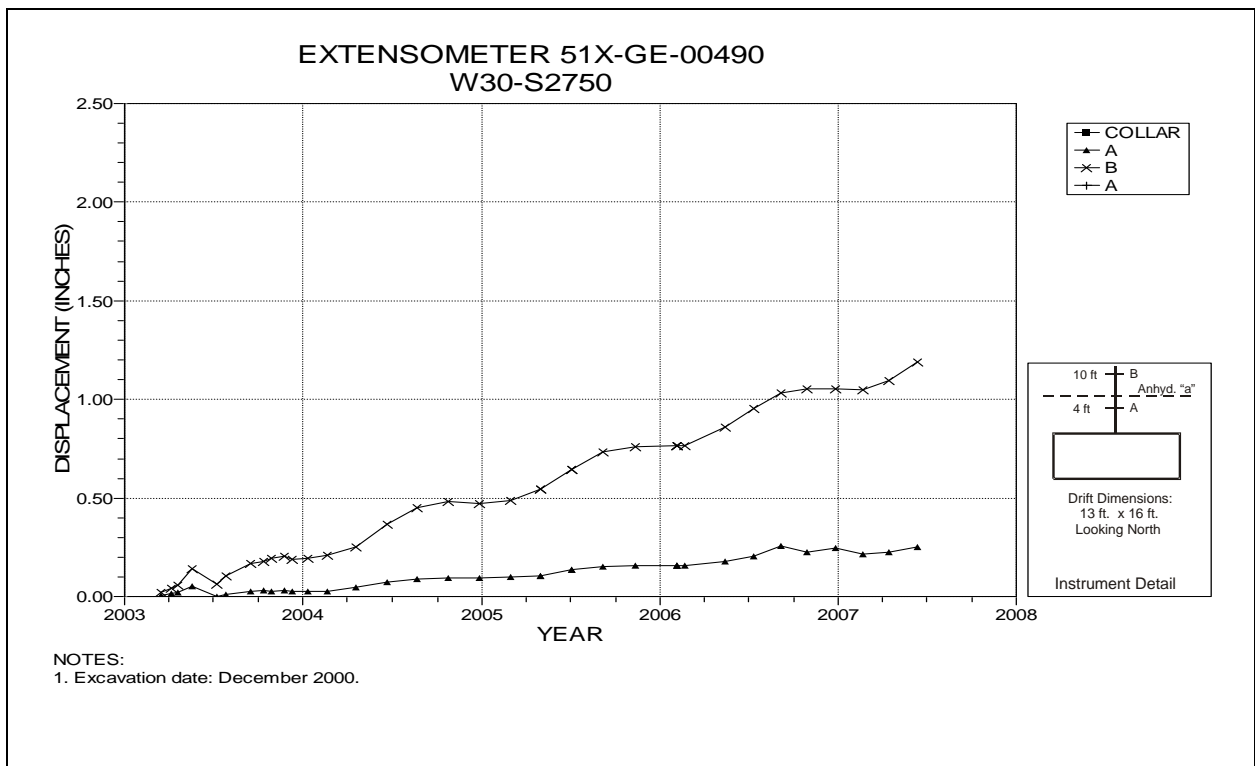


Figure 4-34 Extensometer 51X-GE-00490  
W30 Drift at S2750 Drift Intersection – Roof

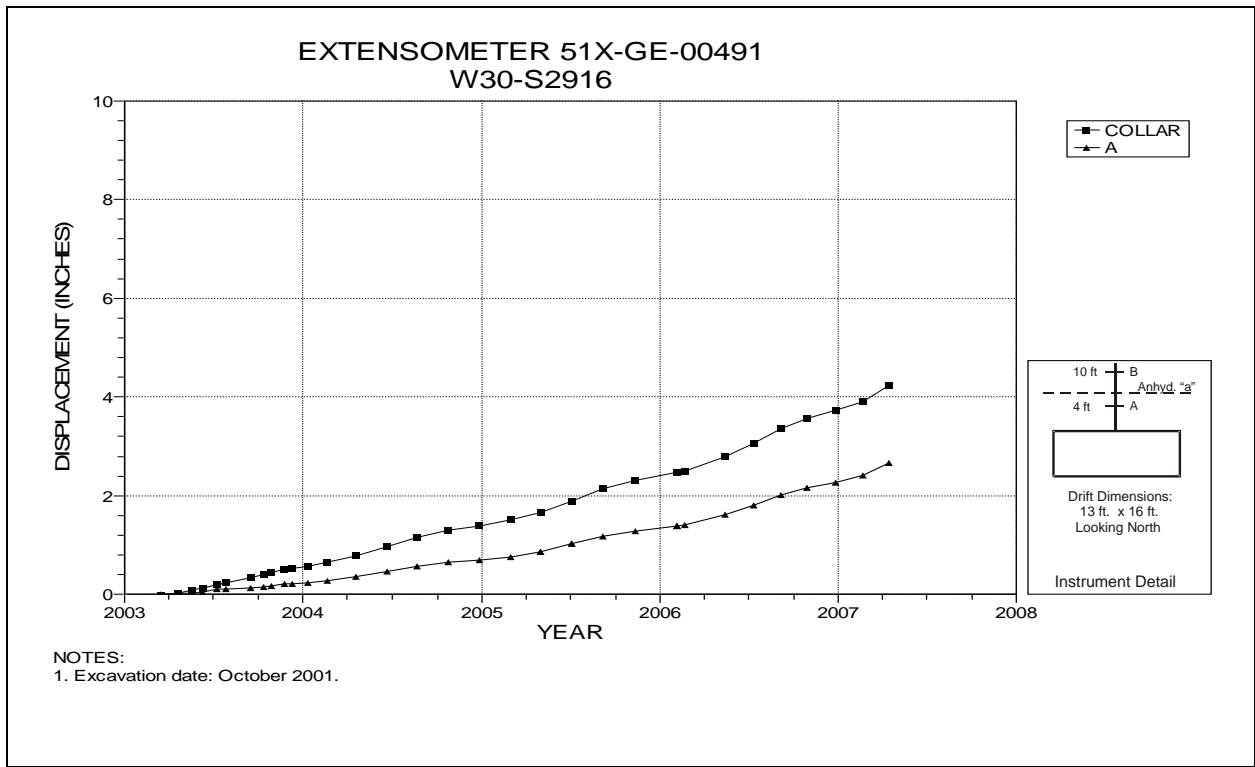


Figure 4-35 Extensometer 51X-GE-00491  
W30 Drift at S2916 – Roof

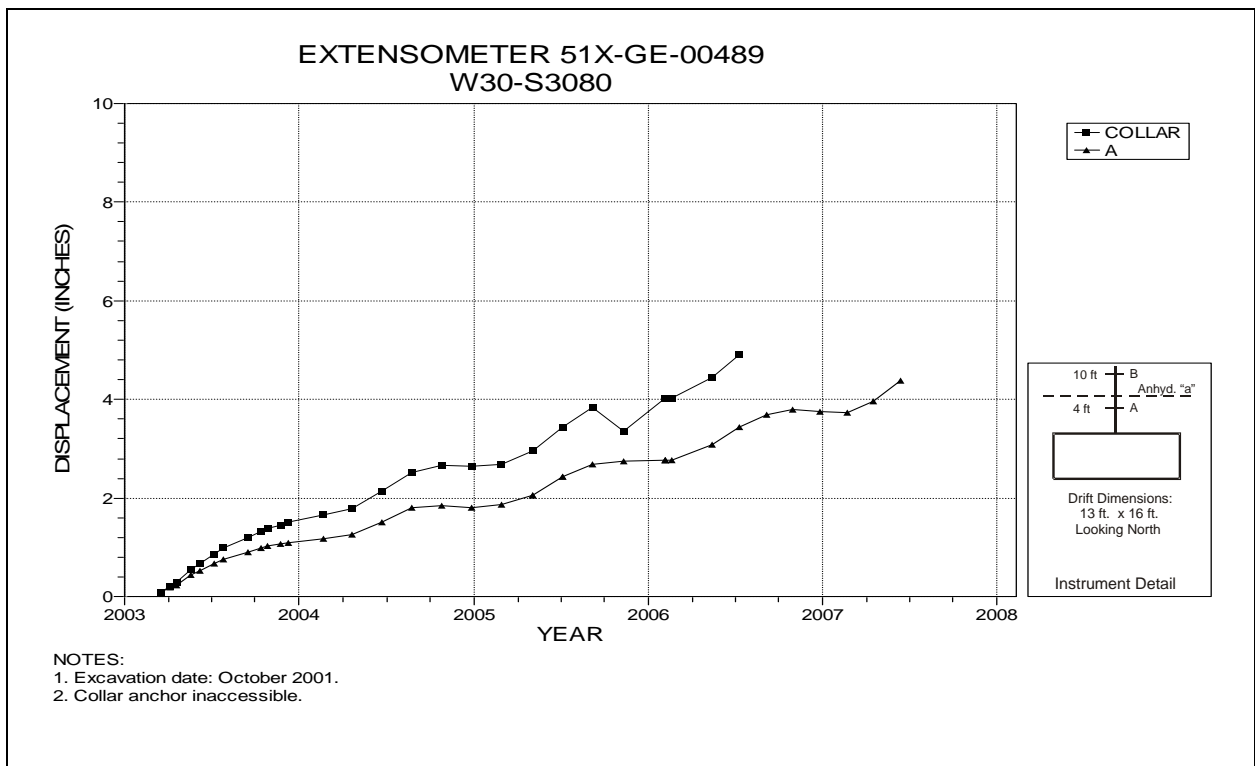


Figure 4-36 Extensometer 51X-GE-00489  
W30 Drift at S3080 Drift Intersection – Roof

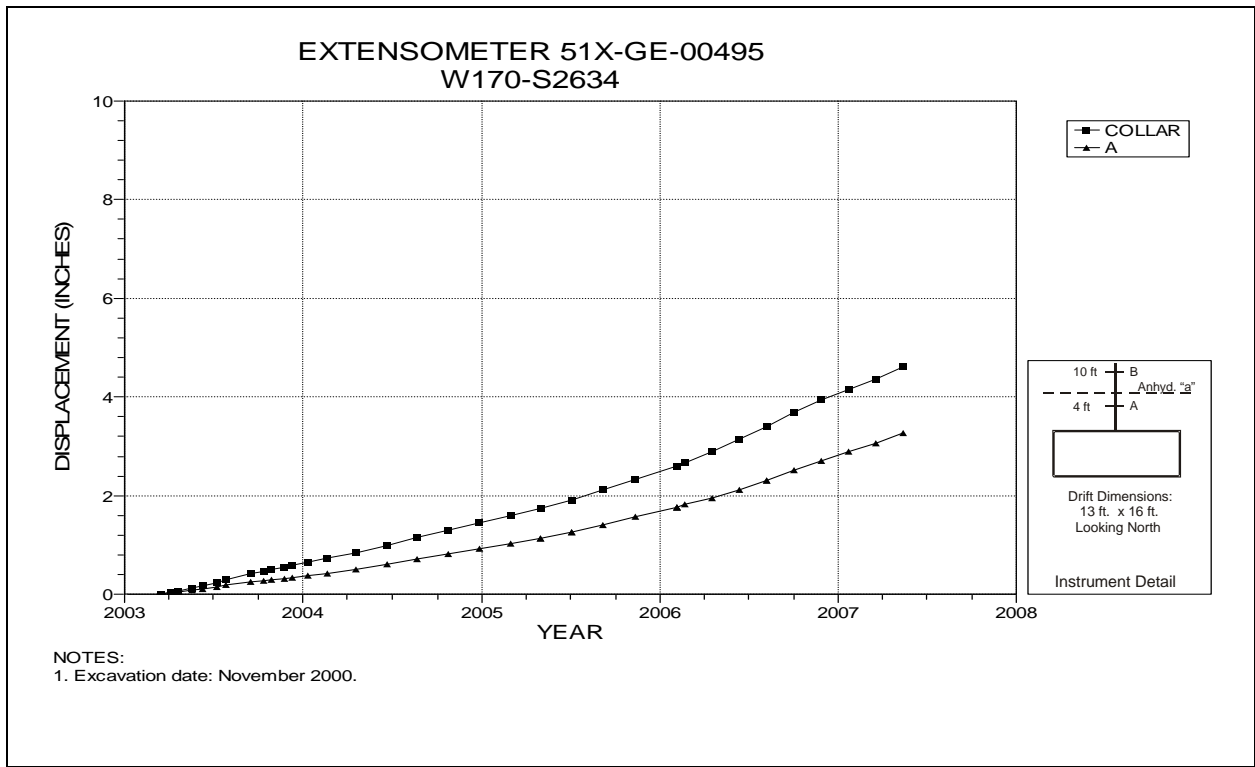


Figure 4-37 Extensometer 51X-GE-00495  
W170 Drift at S2634 – Roof

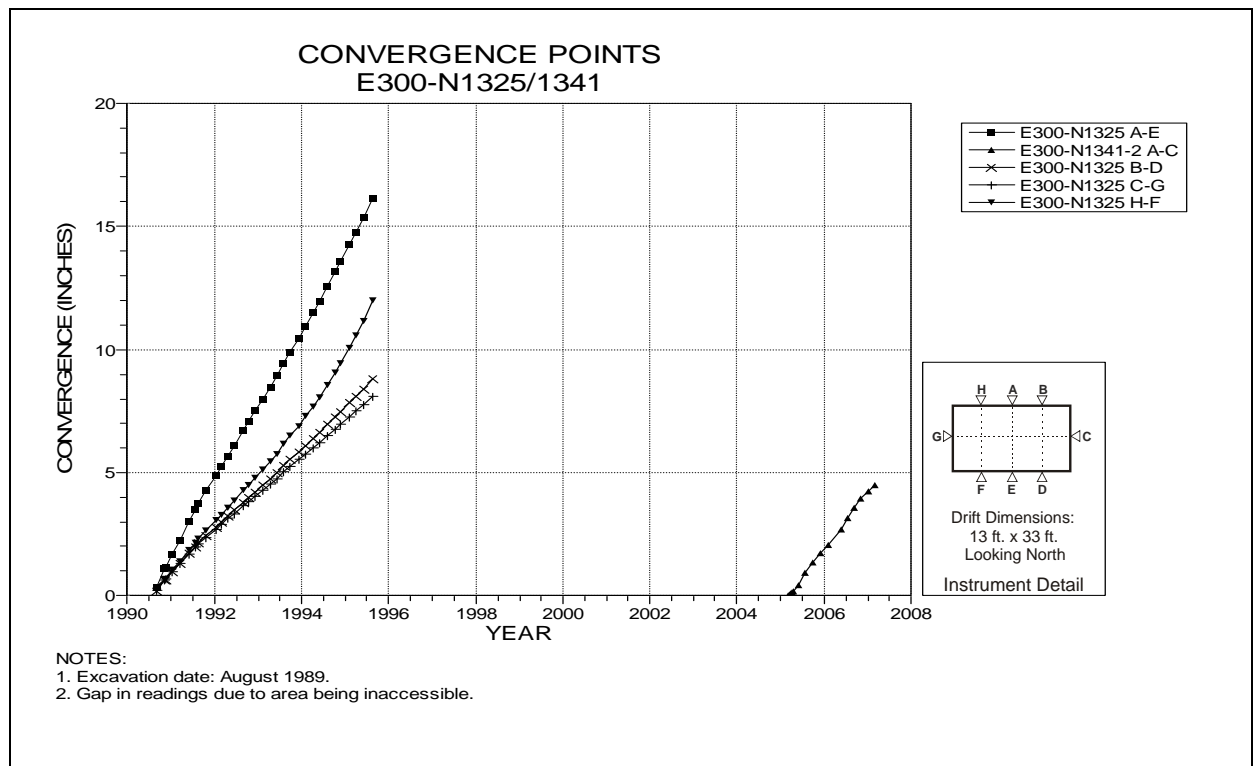


Figure 4-38 Convergence Point Array  
E300 Drift at N1341 – All Chords

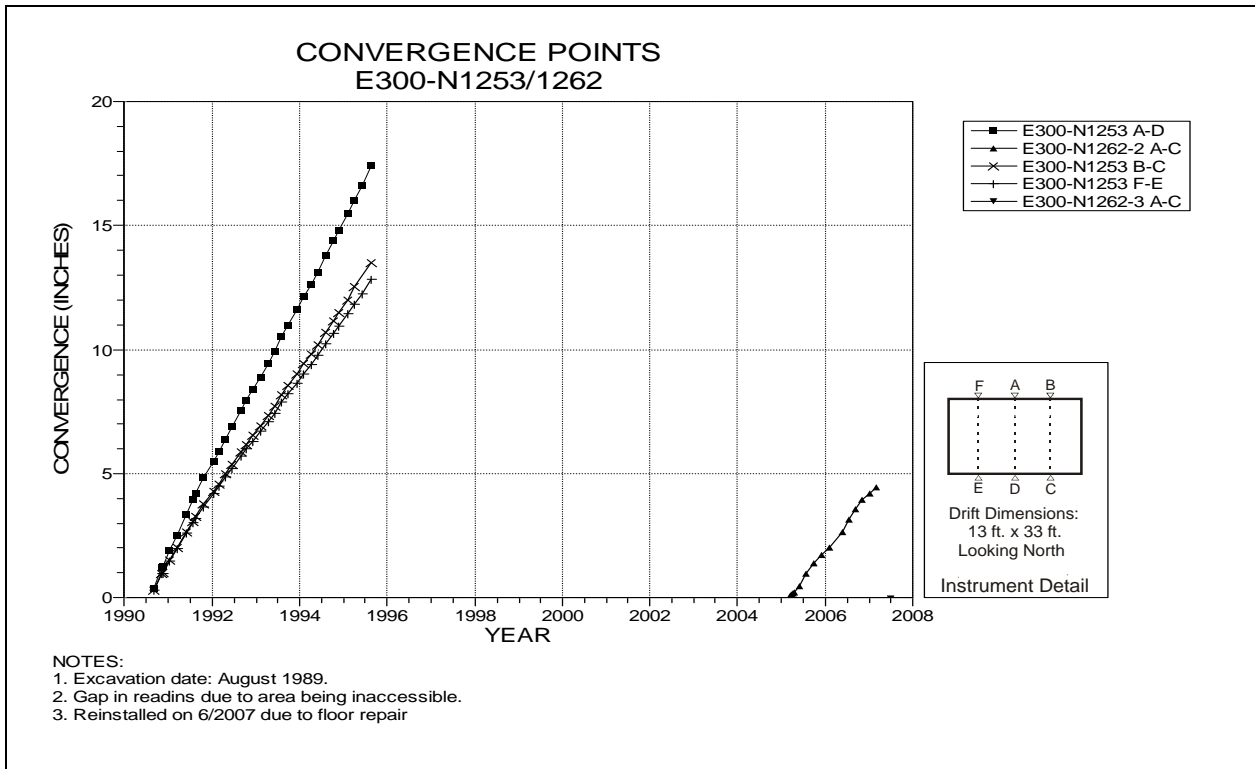


Figure 4-39 Convergence Point Array  
E300 Drift at N1262 – All Chords

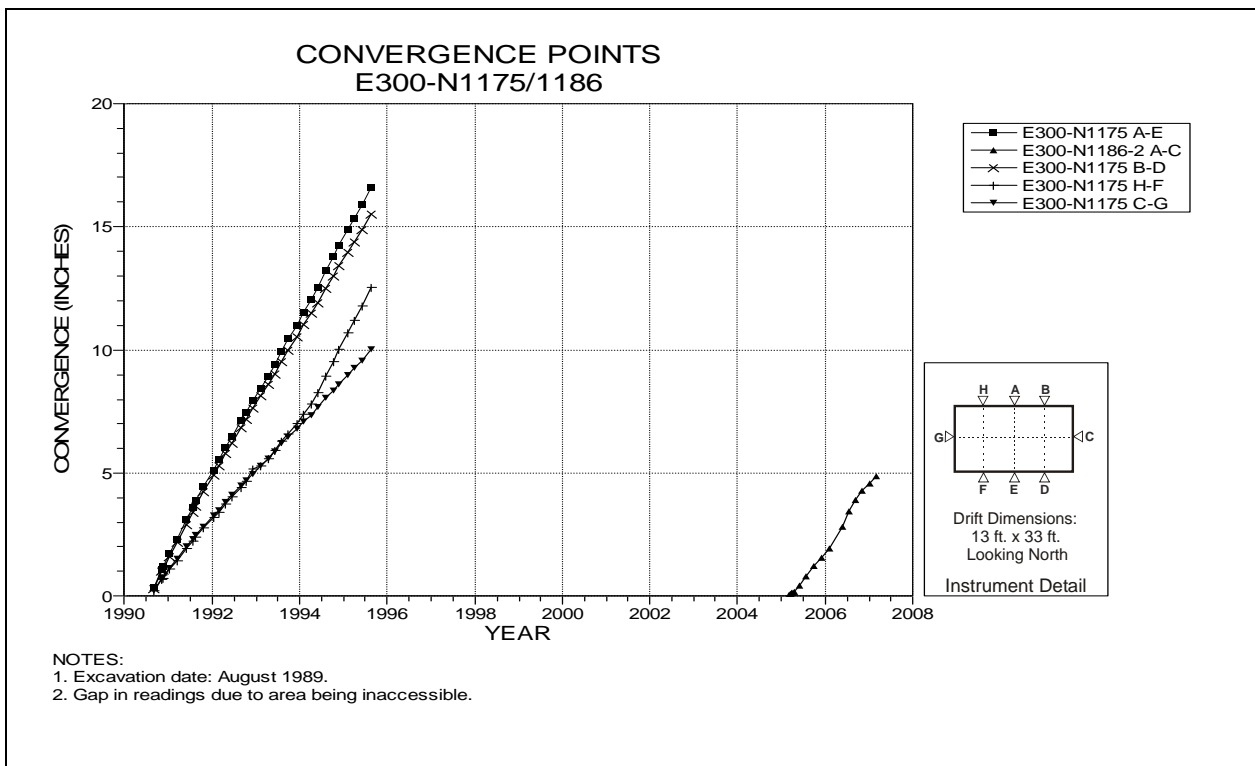


Figure 4-40 Convergence Point Array  
E300 Drift at N1186 – All Chords



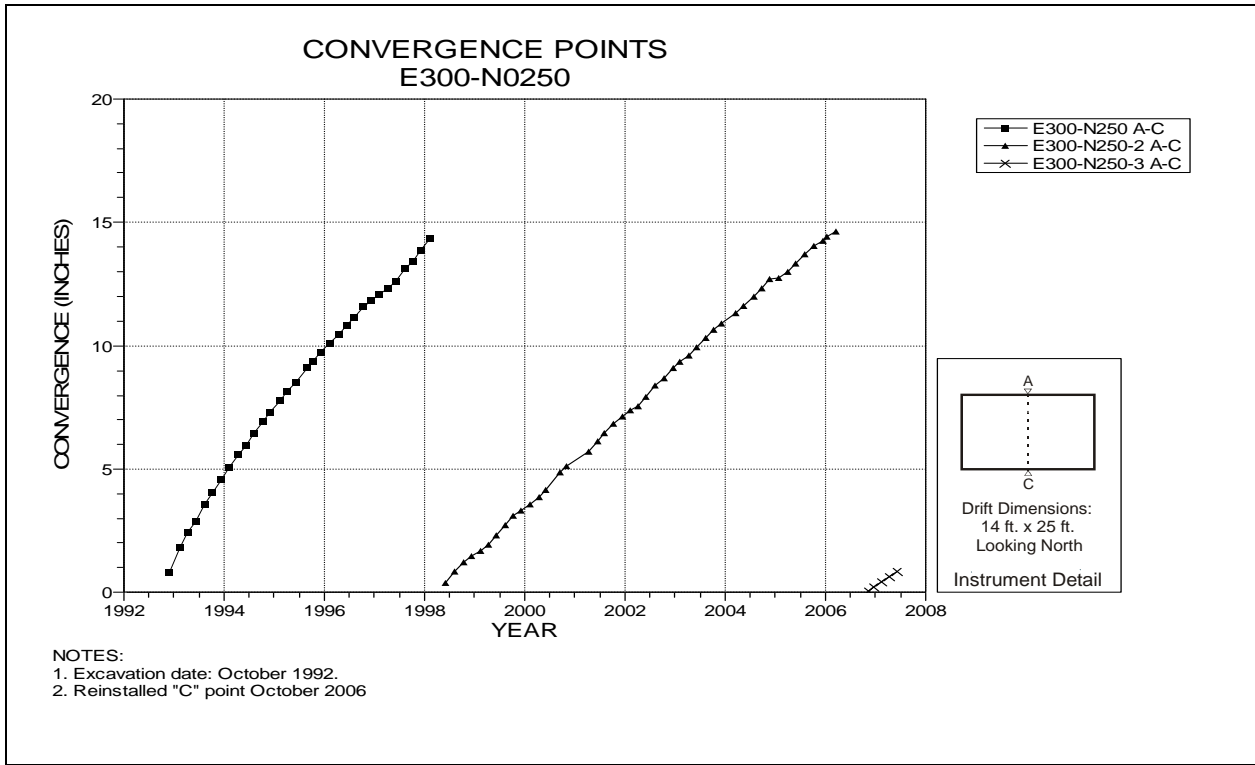


Figure 4-41 Convergence Point Array  
E300 Shop – E300 Drift at N250 – Roof to Floor

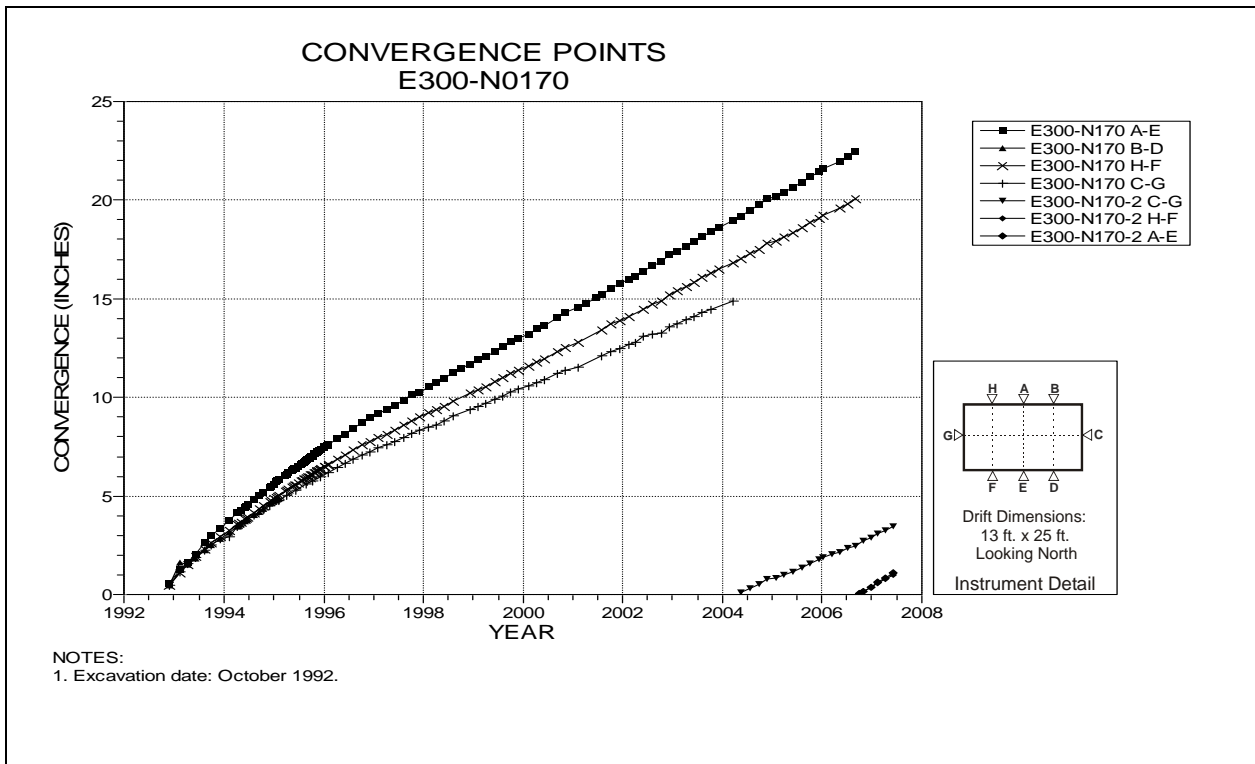


Figure 4-42 Convergence Point Array  
E300 Shop – E300 Drift at N170 – All Chords

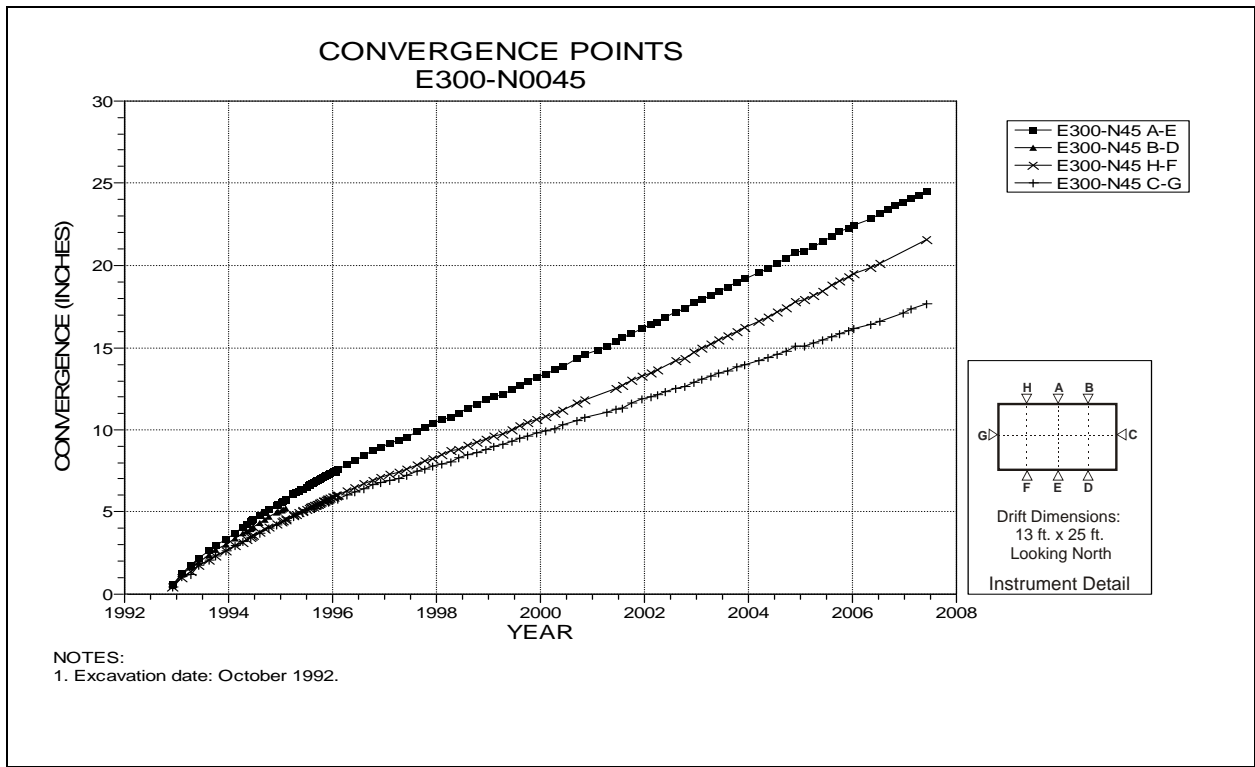


Figure 4-43 Convergence Point Array  
E300 Shop – E300 Drift at N45 – All Chords

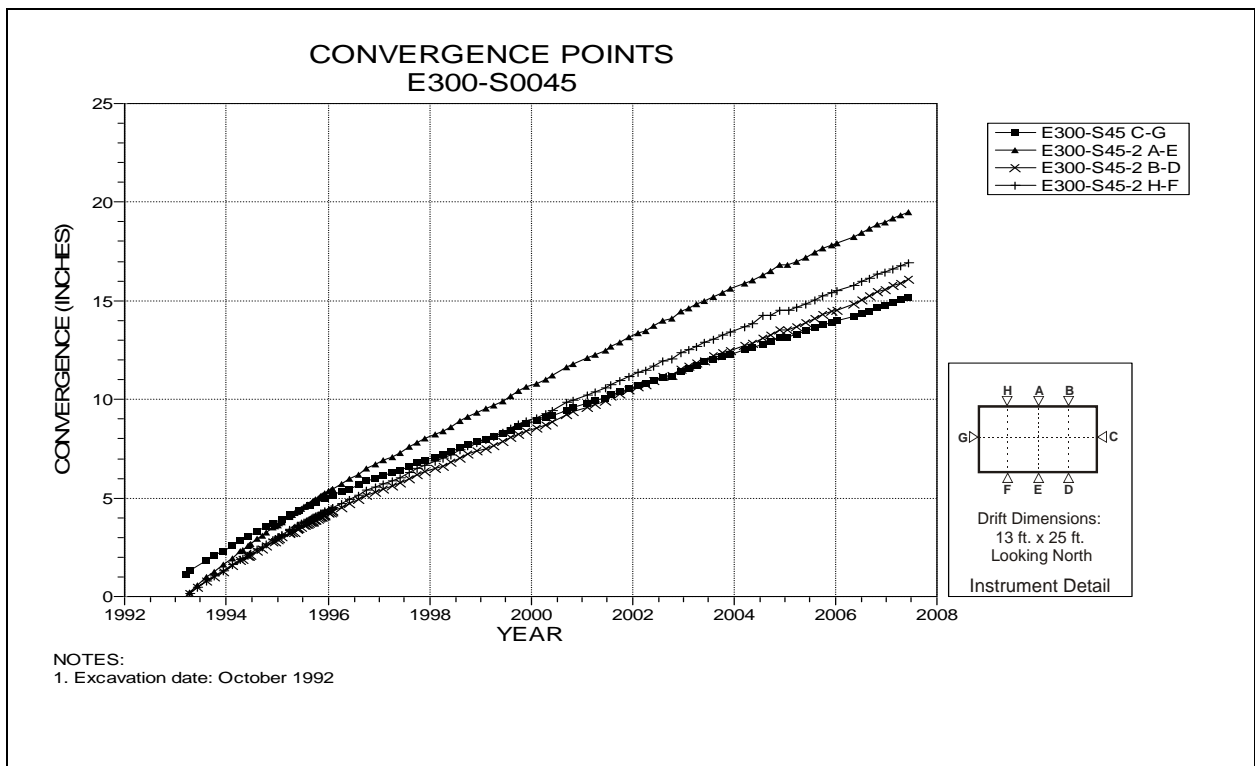


Figure 4-44 Convergence Point Array  
E300 Shop – E300 Drift at S45 – All Chords

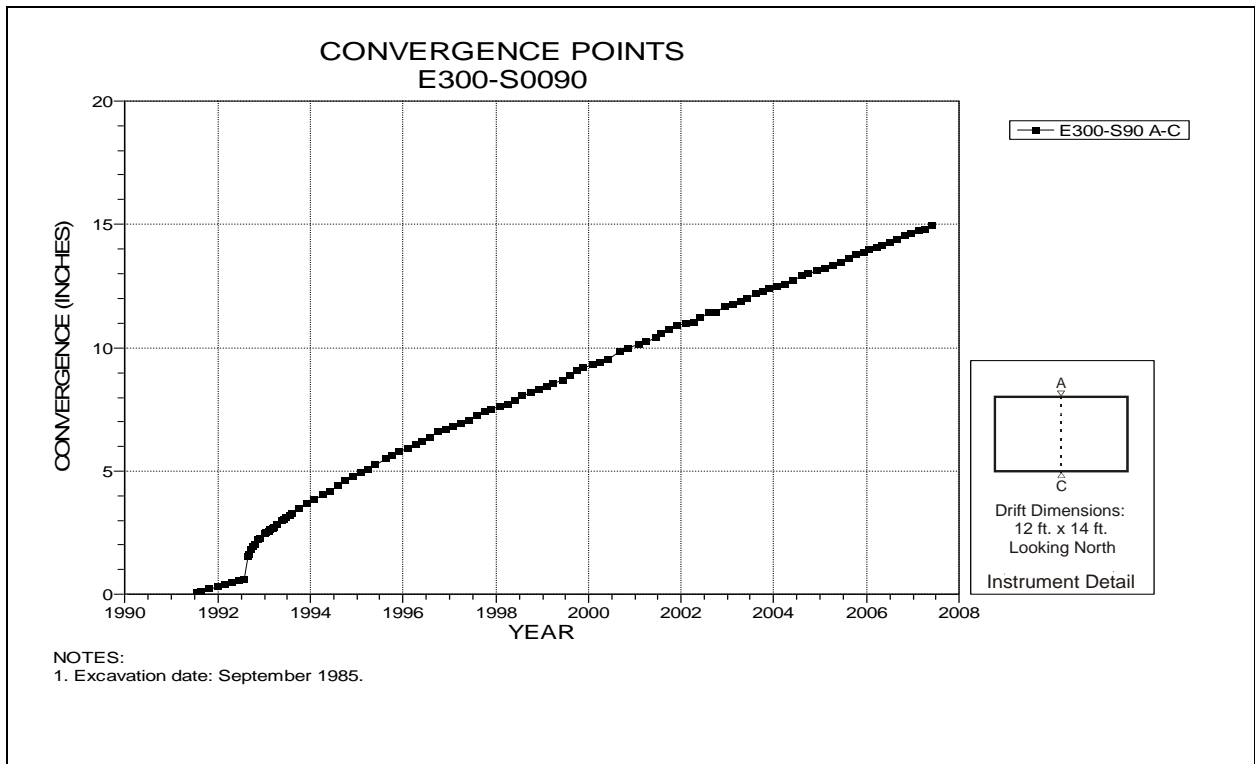


Figure 4-45 Convergence Point Array  
E300 Drift at S90 Drift Intersection – Roof to Floor

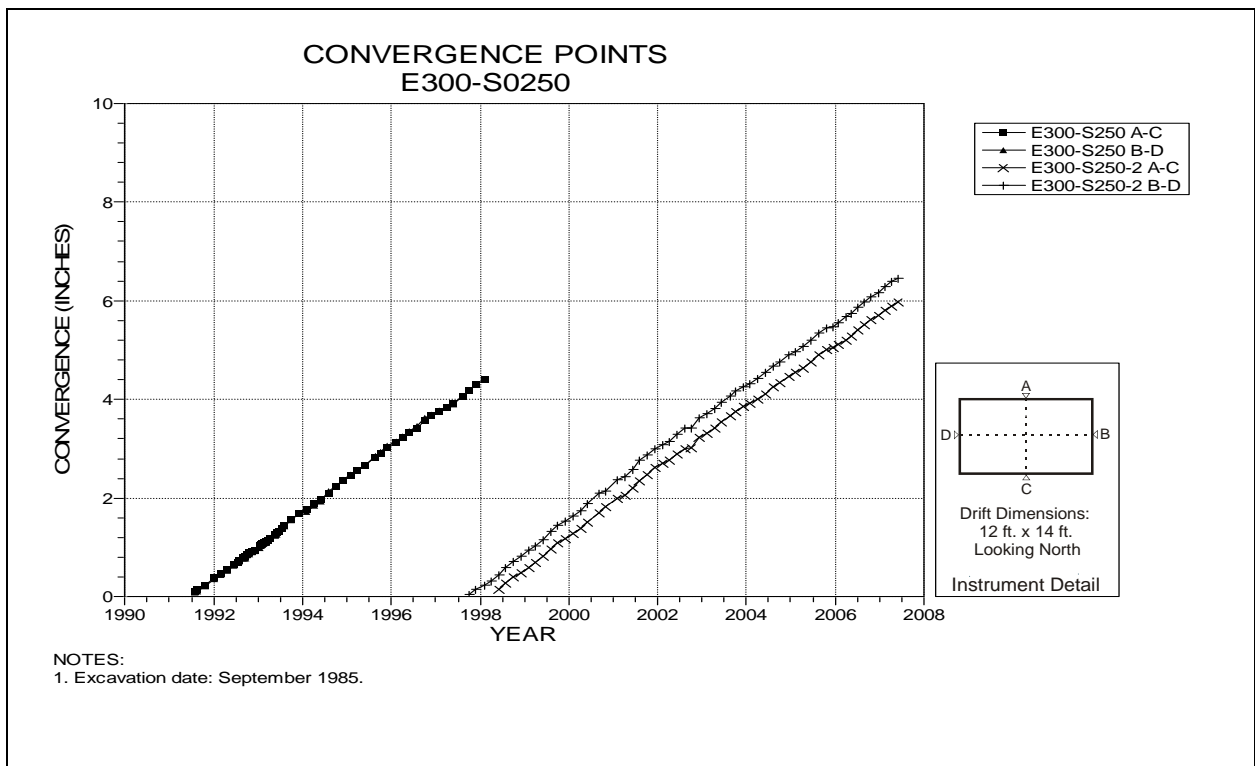


Figure 4-46 Convergence Point Array  
E300 Drift at S250 – All Chords

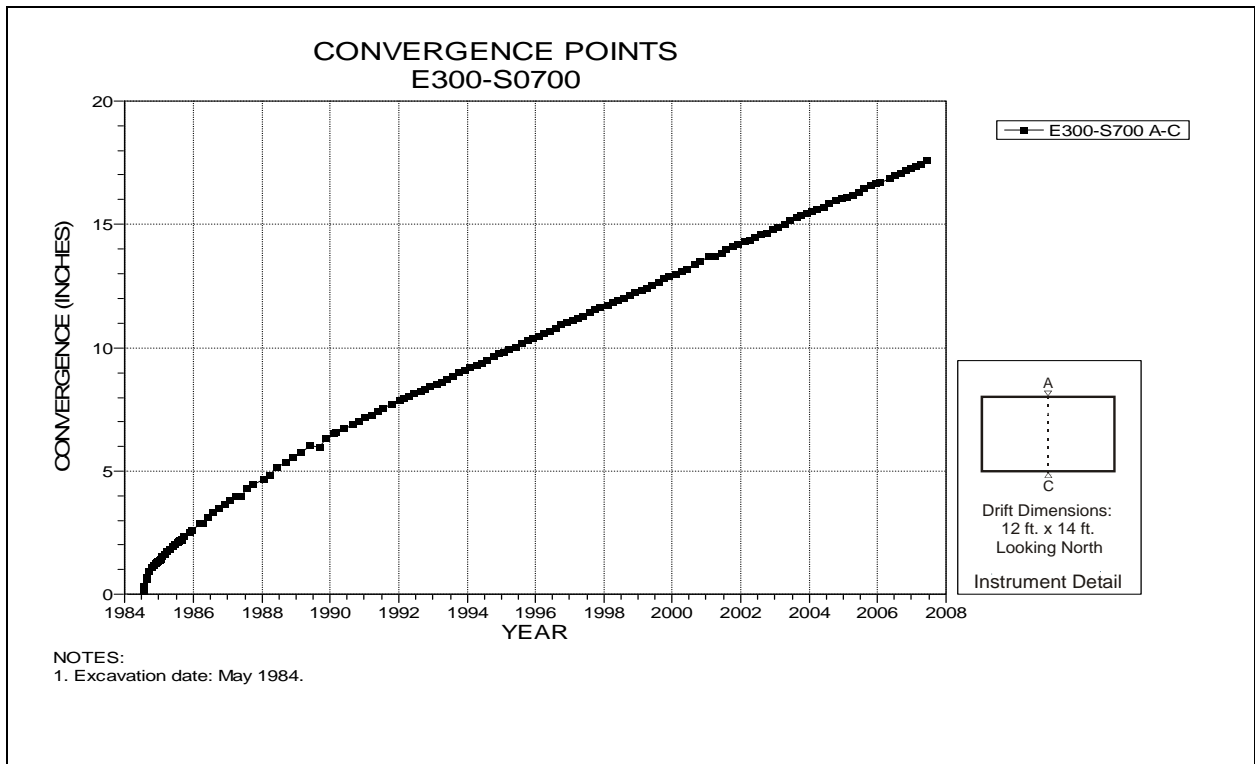


Figure 4-47 Convergence Point Array  
E300 Drift at S700 Drift Intersection – Roof to Floor

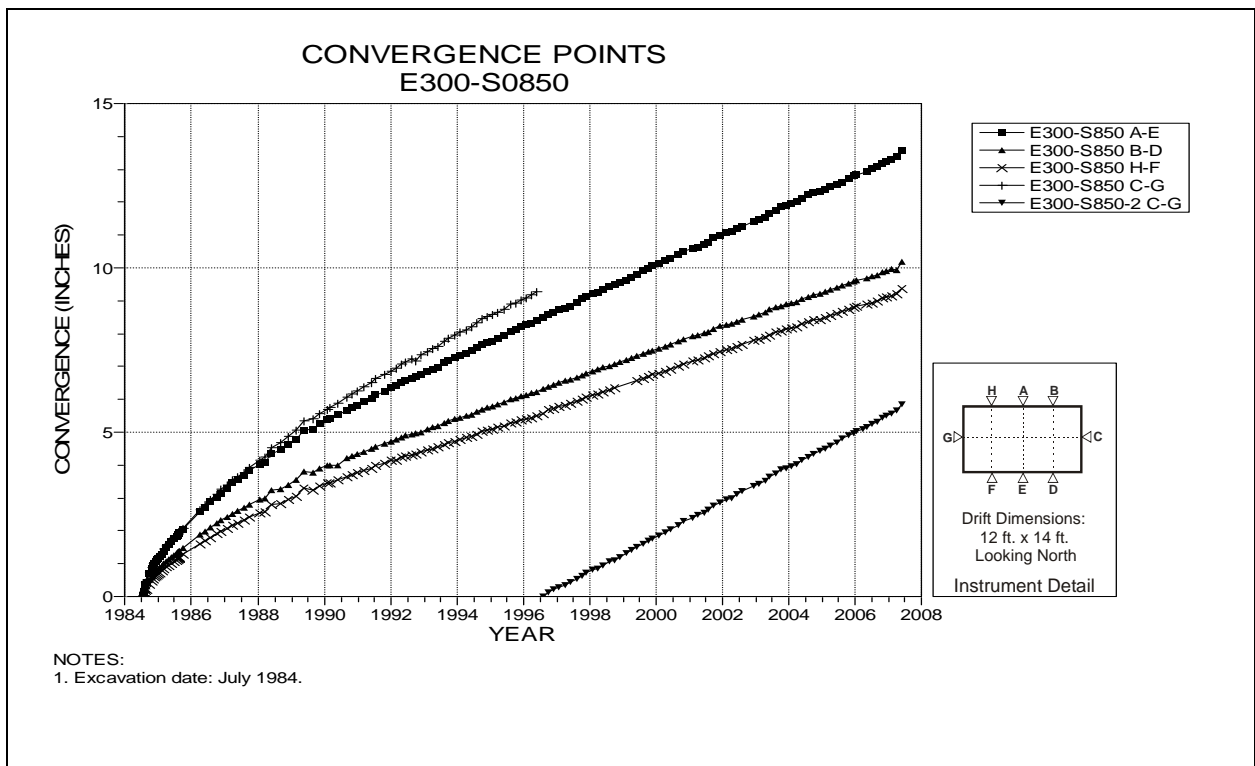


Figure 4-48 Convergence Point Array  
E300 Drift at S850 – All Chords

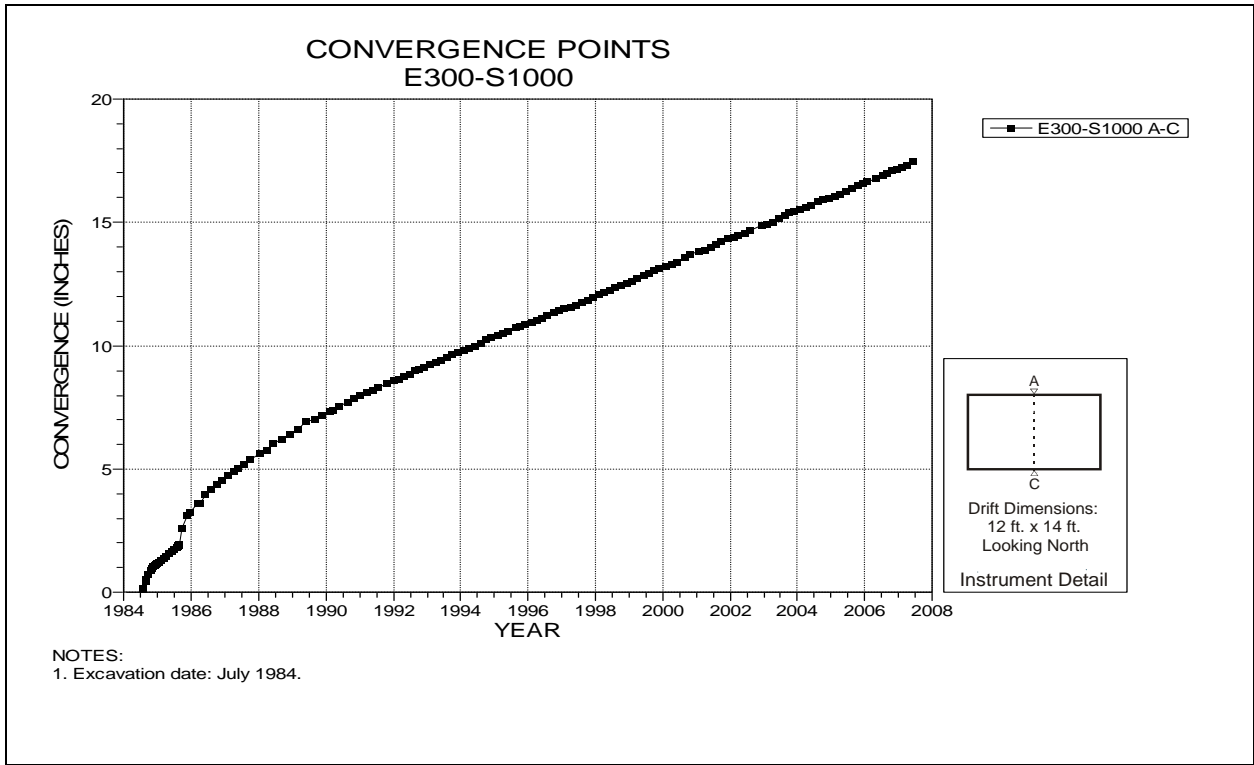


Figure 4-49 Convergence Point Array  
E300 Drift at S1000 Drift Intersection – Roof to Floor

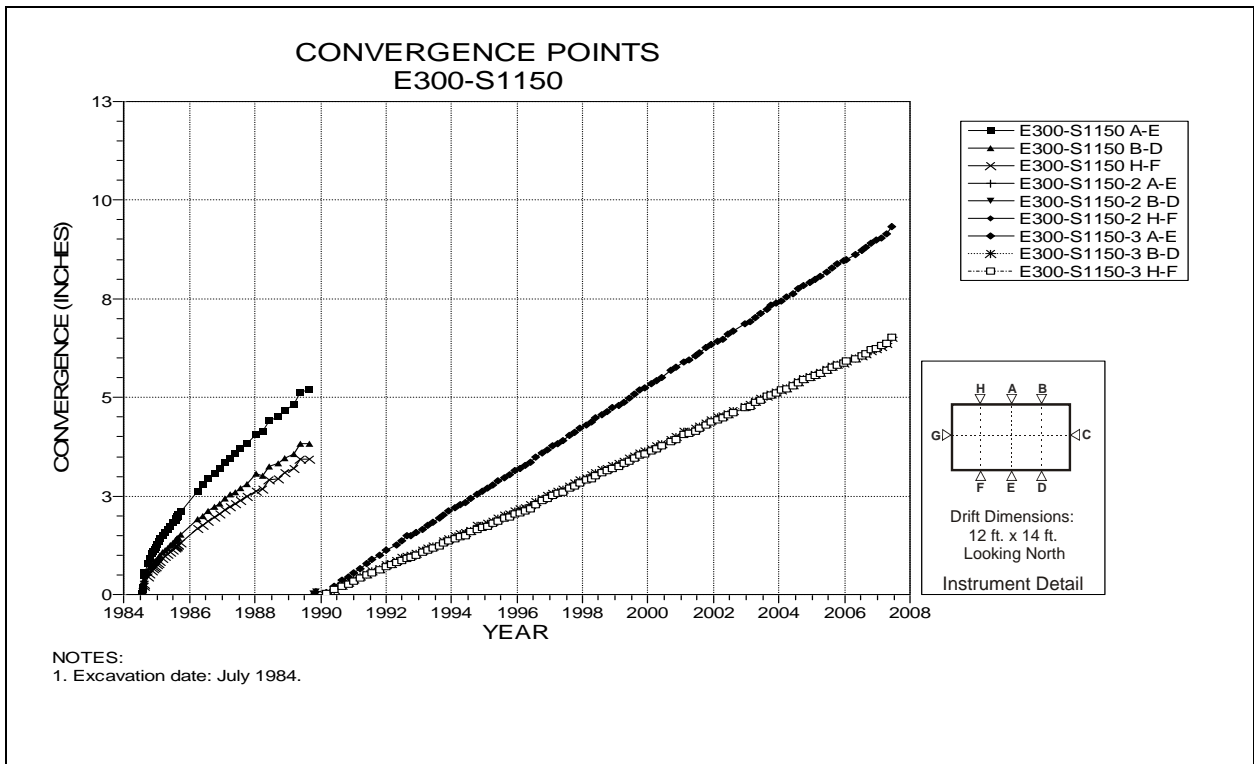


Figure 4-50 Convergence Point Array  
E300 Drift at S1150 – Roof to Floor

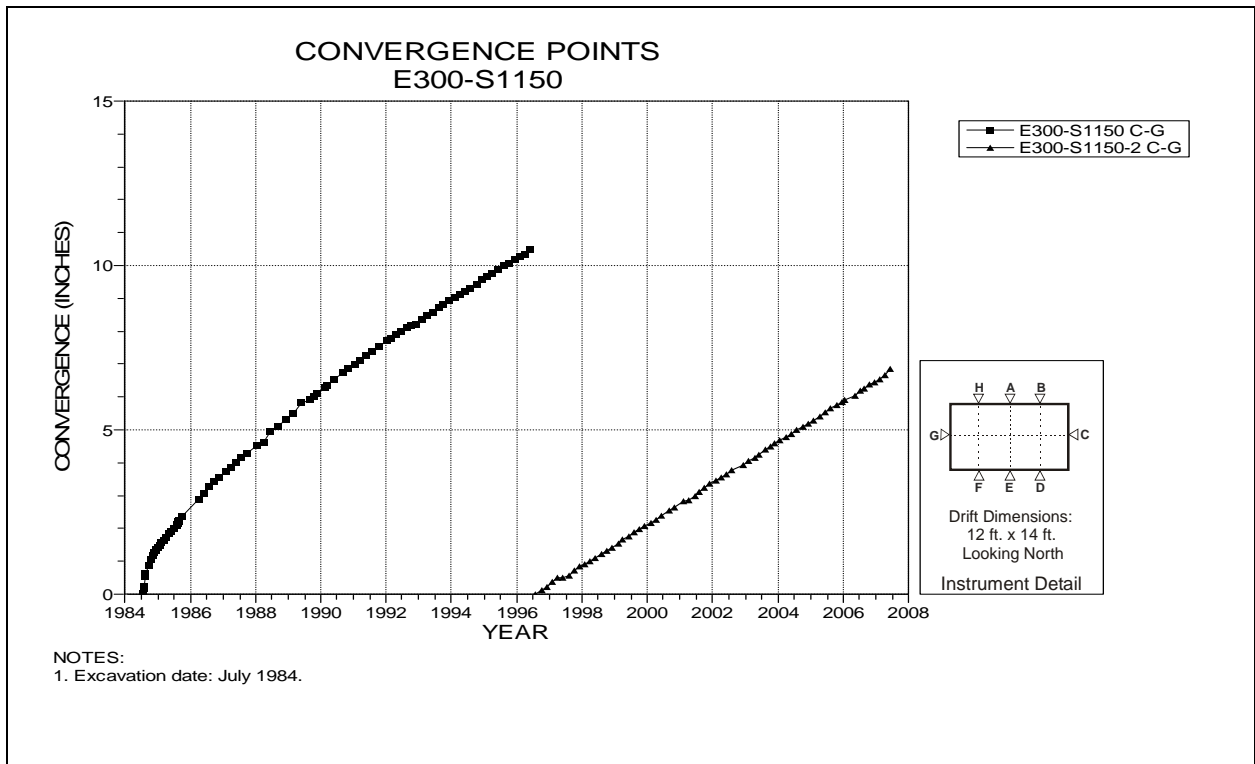


Figure 4-51 Convergence Point Array  
E300 Drift at S1150 – Rib to Rib

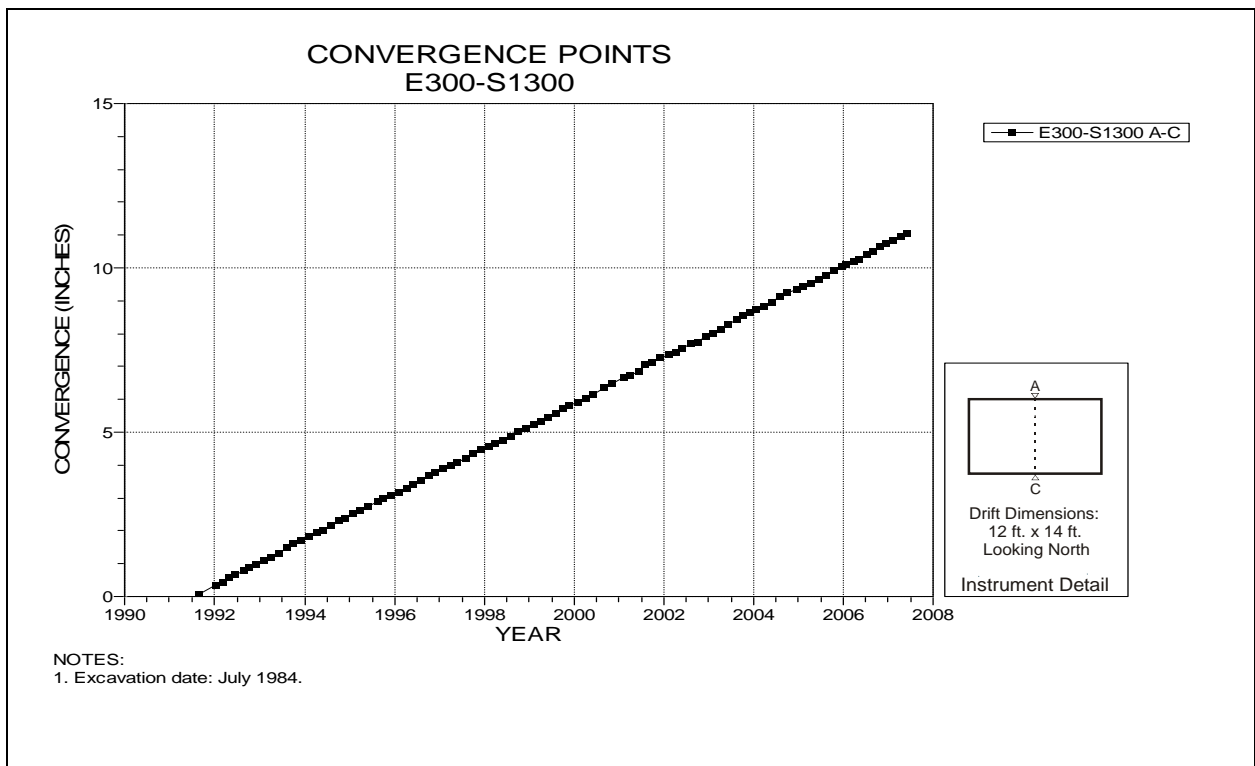


Figure 4-52 Convergence Point Array  
E300 Drift at S1300 Drift Intersection – Roof to Floor

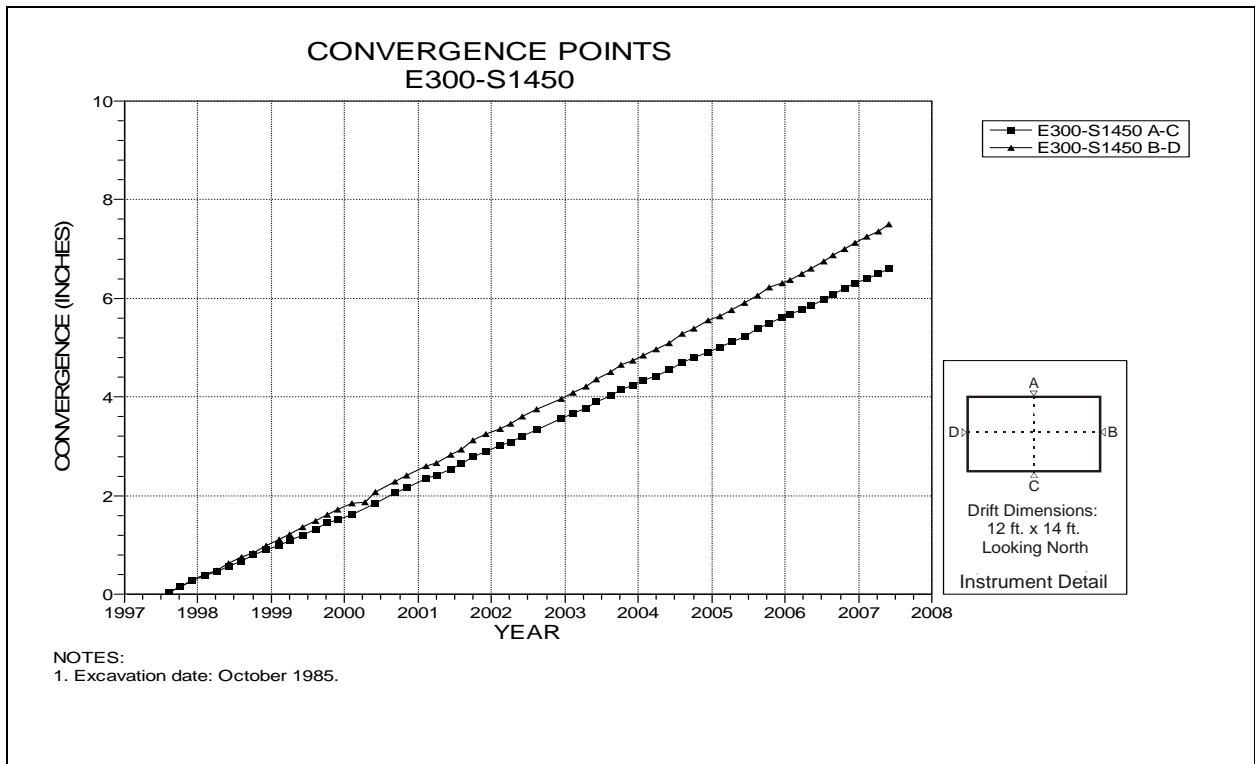


Figure 4-53 Convergence Point Array  
E300 Drift at S1450 – All Chords

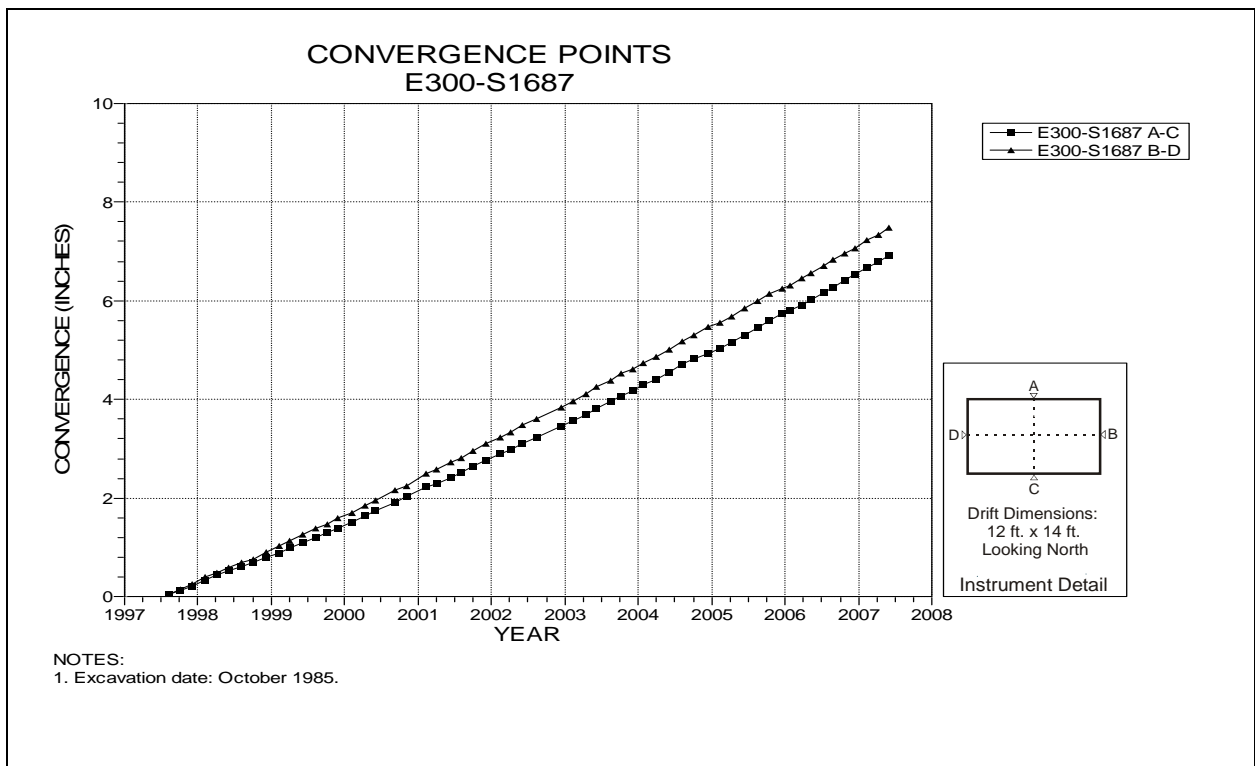


Figure 4-54 Convergence Point Array  
E300 Drift at S1687 – All Chords

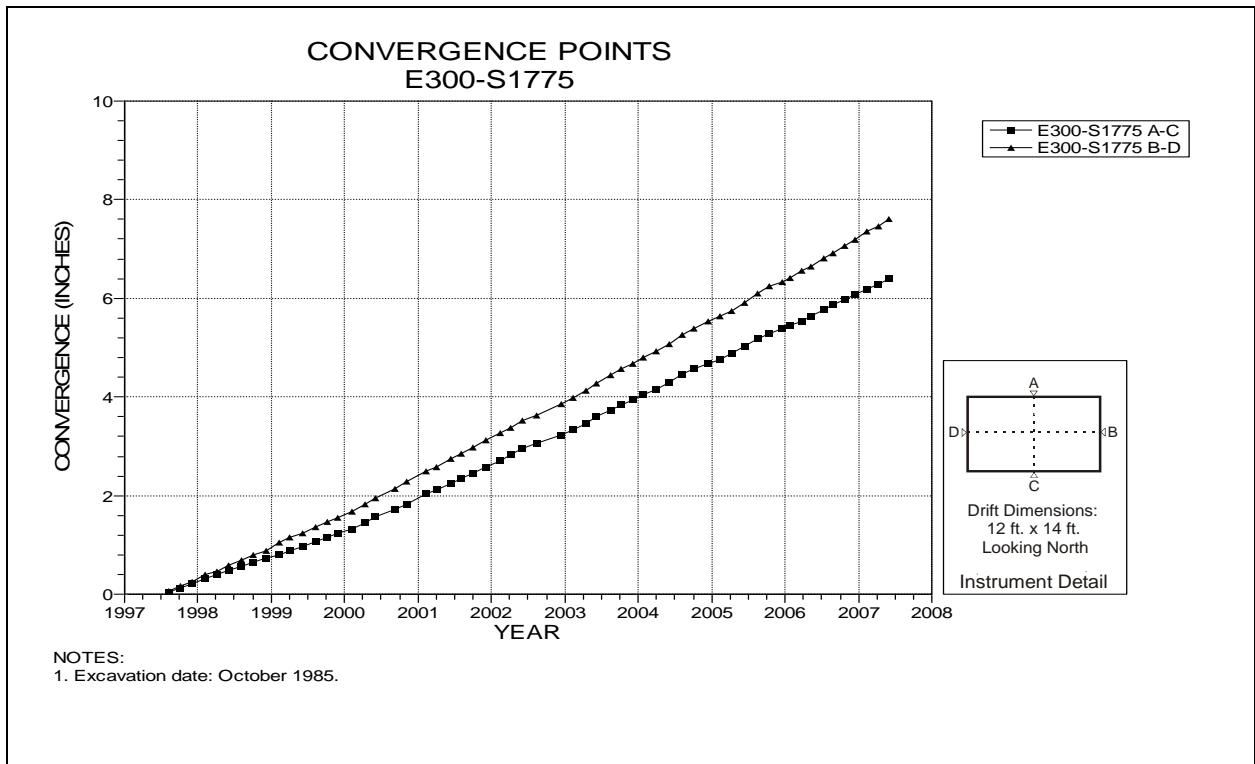


Figure 4-55 Convergence Point Array  
E300 Drift at S1775 – All Chords

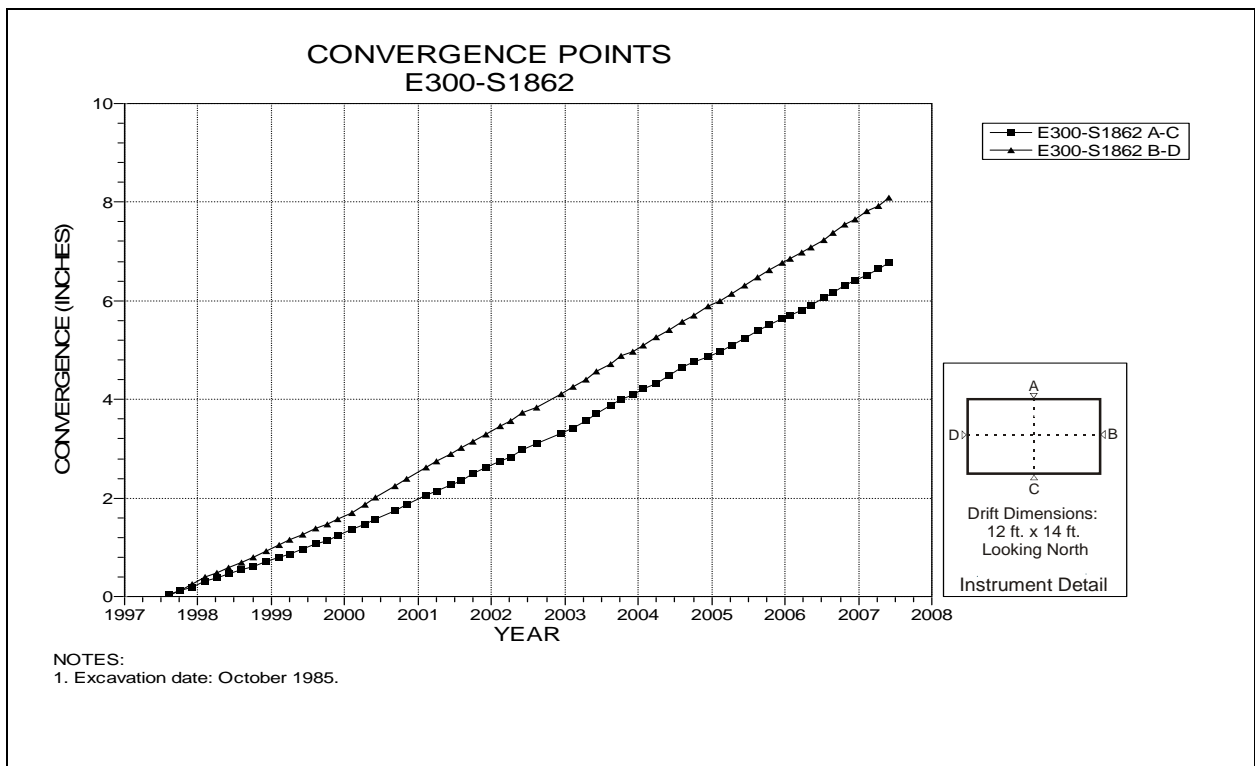


Figure 4-56 Convergence Point Array  
E300 Drift at S1862 – All Chords



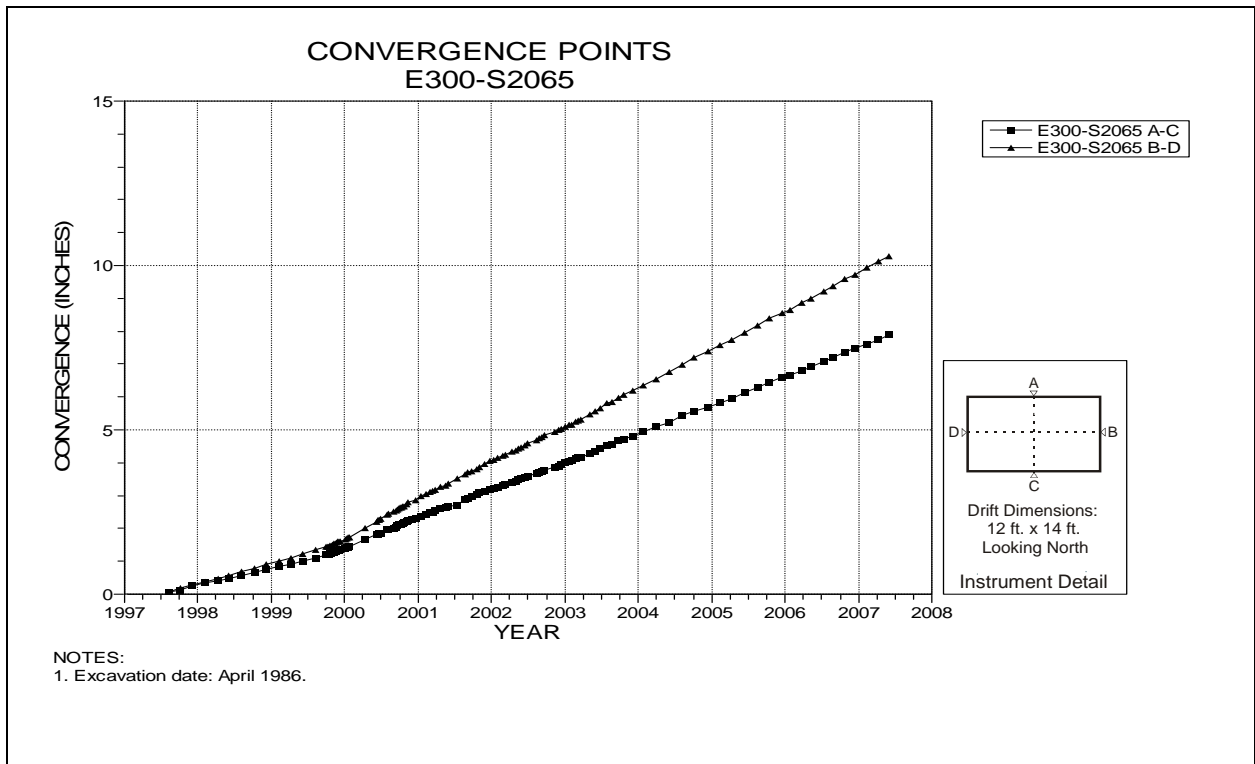


Figure 4-57 Convergence Point Array  
E300 Drift at S2065 – All Chords

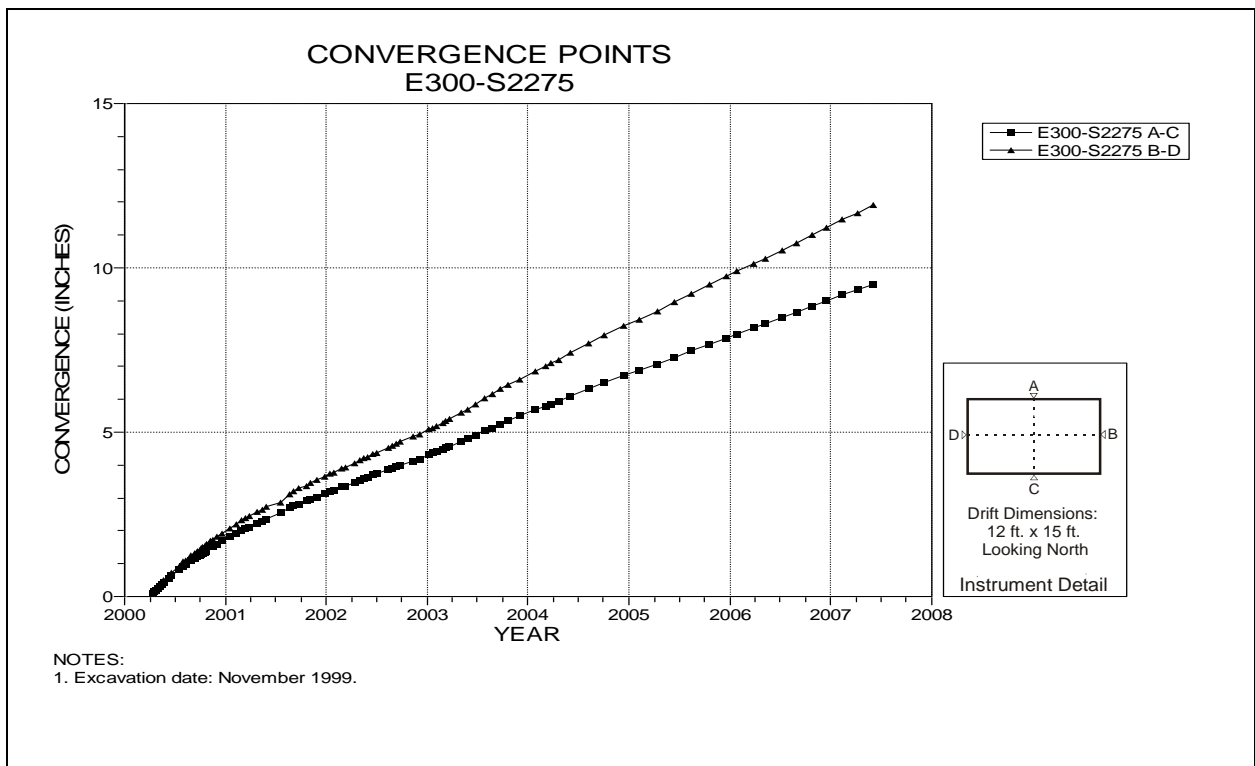


Figure 4-58 Convergence Point Array  
E300 Drift at S2275 – All Chords

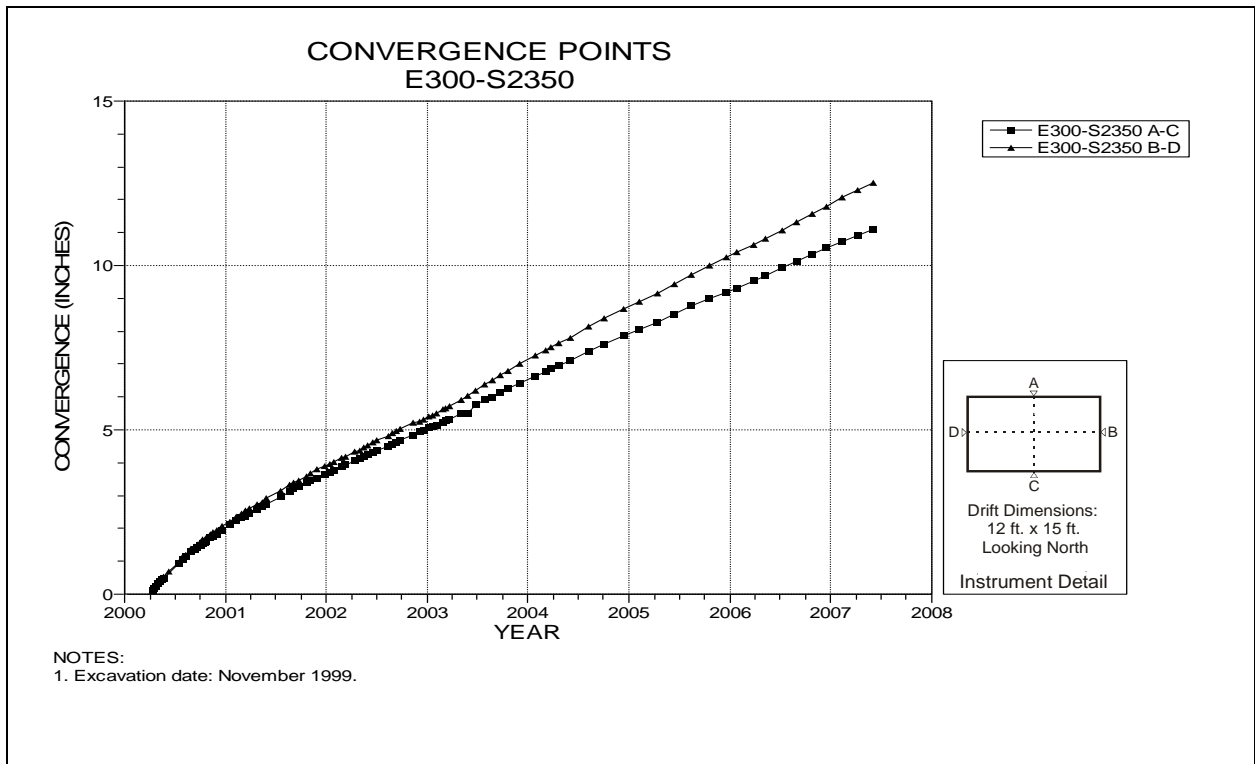


Figure 4-59 Convergence Point Array  
E300 Drift at S2350 – All Chords

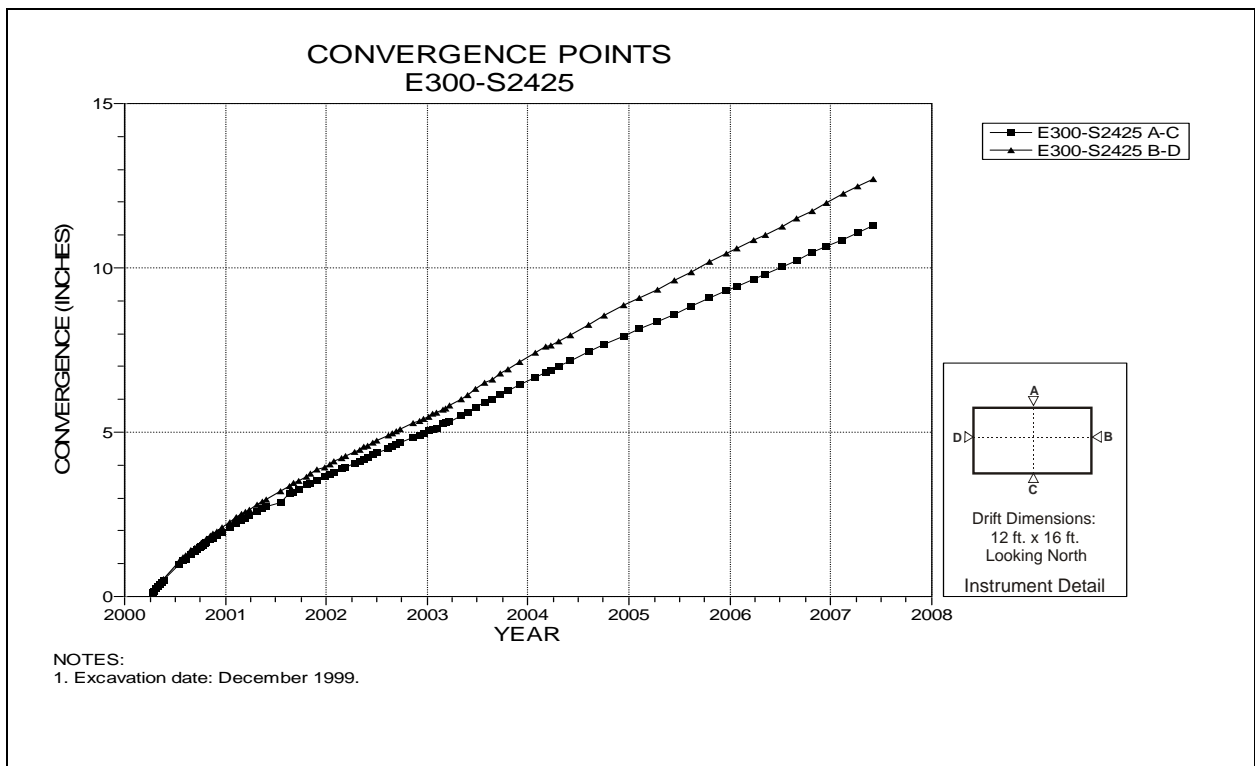


Figure 4-60 Convergence Point Array  
E300 Drift at S2425 – All Chords

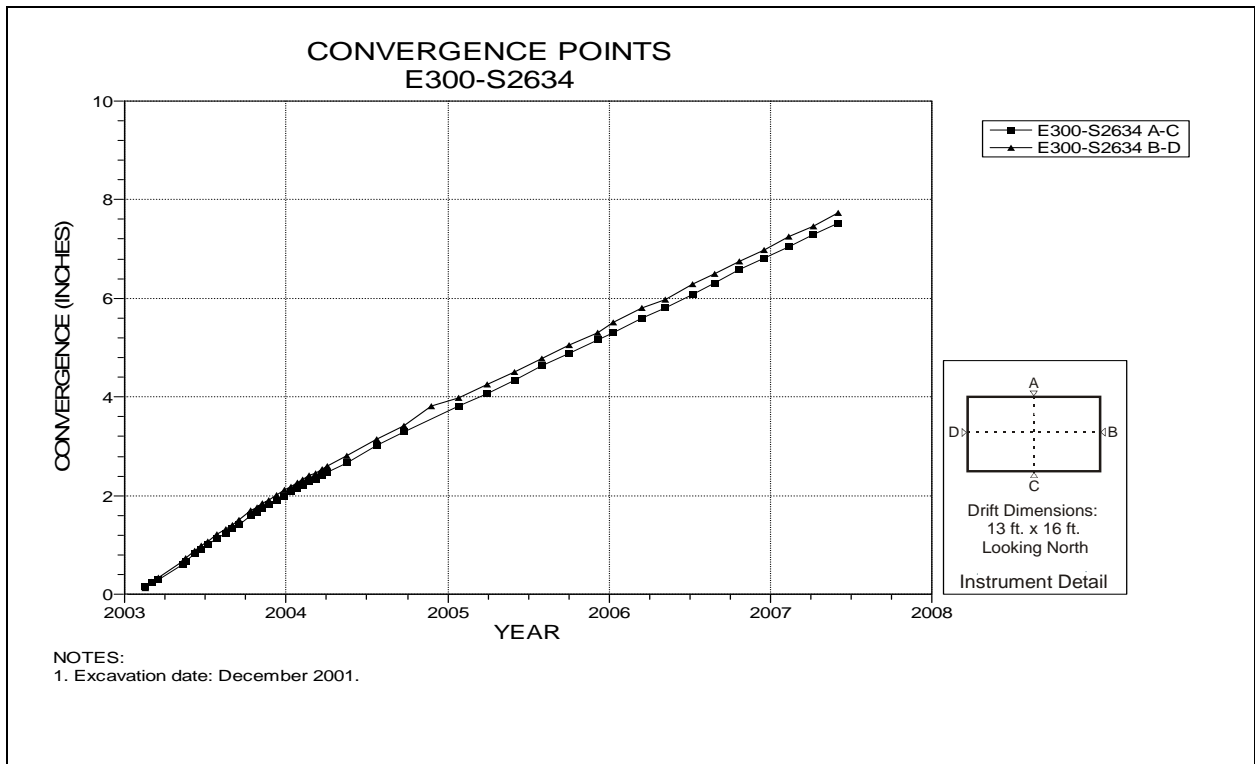


Figure 4-61 Convergence Point Array  
E300 Drift at S2634 – All Chords

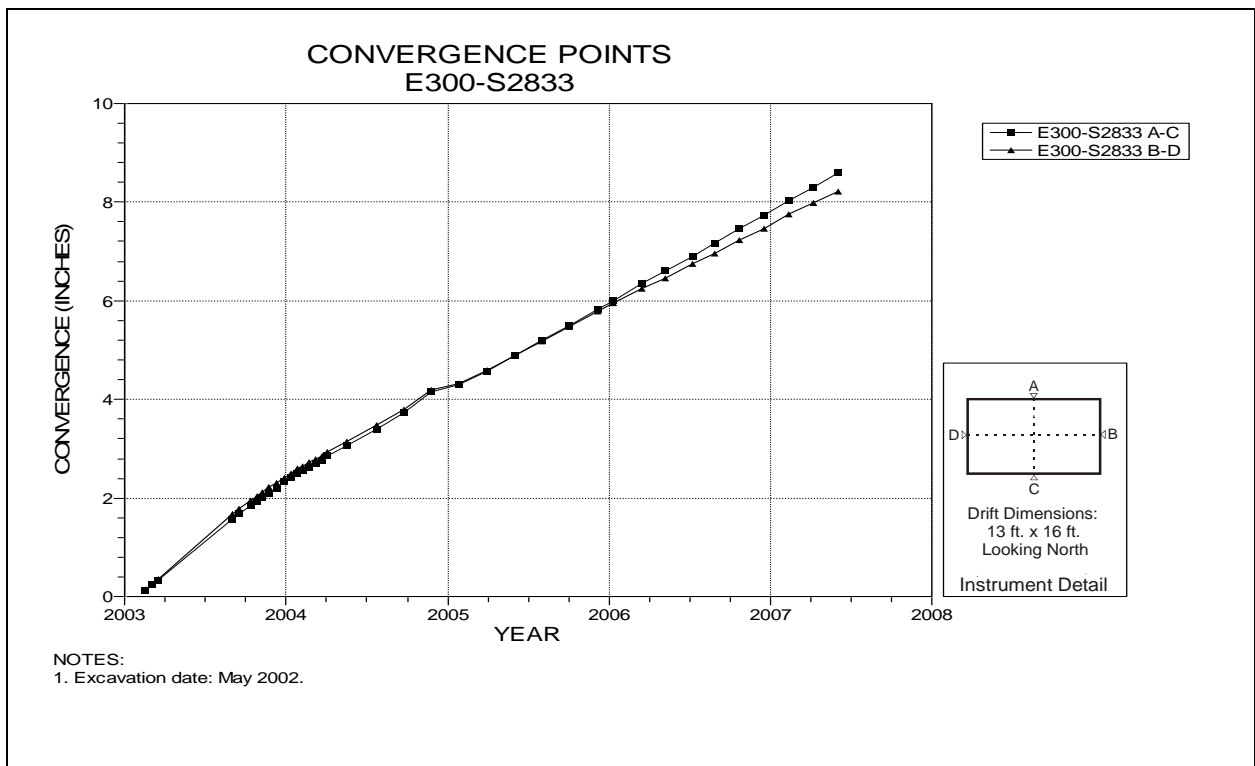


Figure 4-62 Convergence Point Array  
E300 Drift at S2833 – All Chords

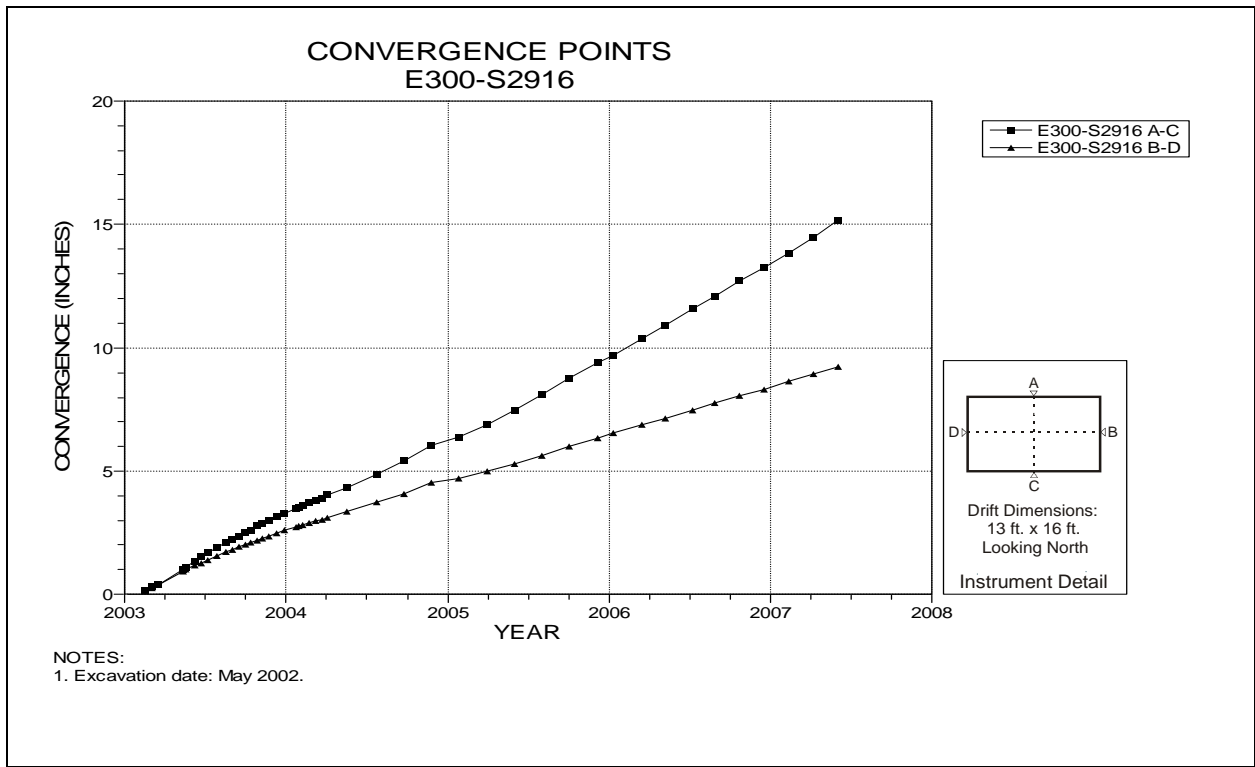


Figure 4-63 Convergence Point Array  
E300 Drift at S2916 – All Chords

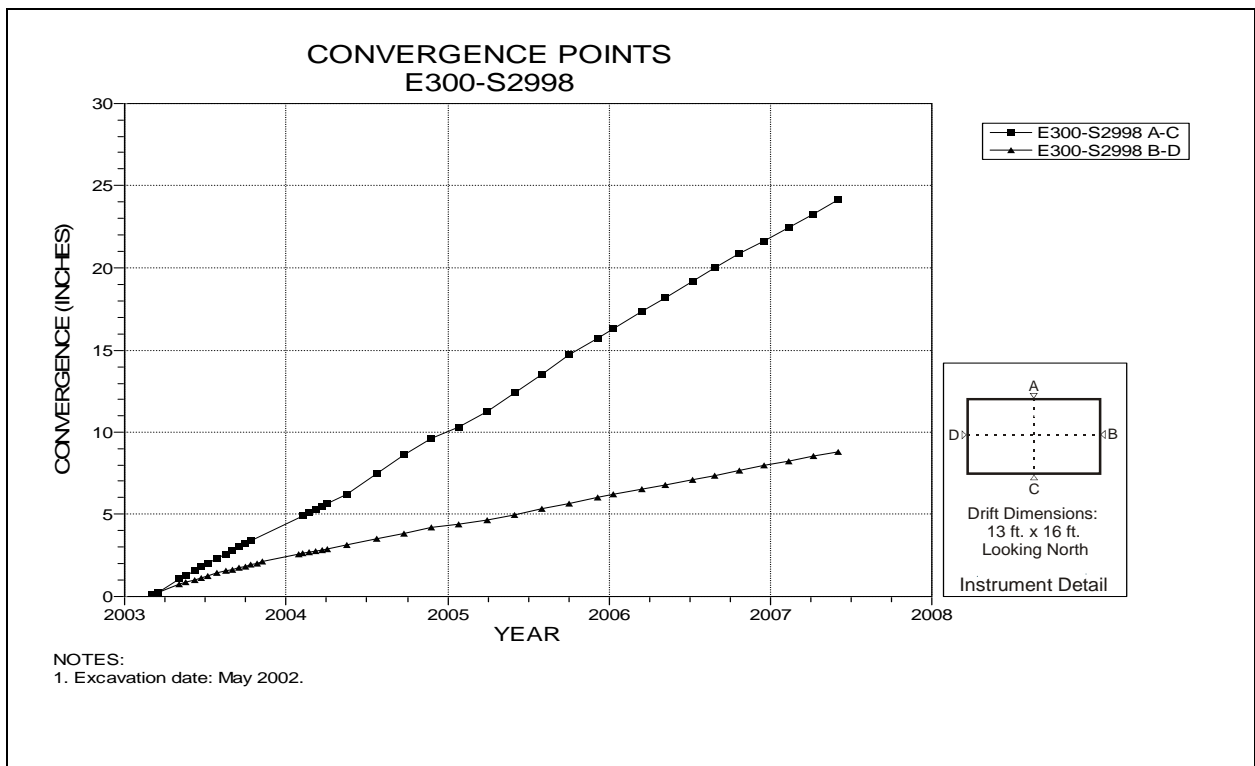


Figure 4-64 Convergence Point Array  
E300 Drift at S2998 – All Chords

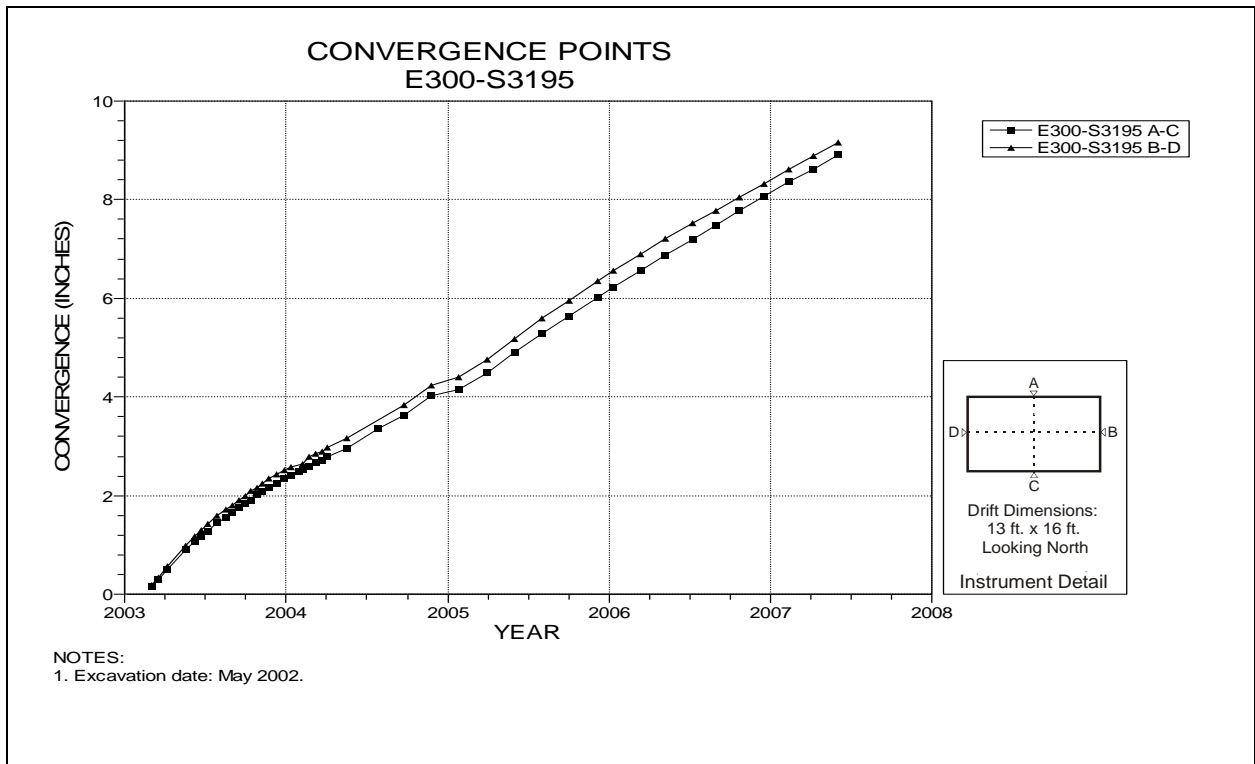


Figure 4-65 Convergence Point Array  
E300 Drift at S3195 – All Chords

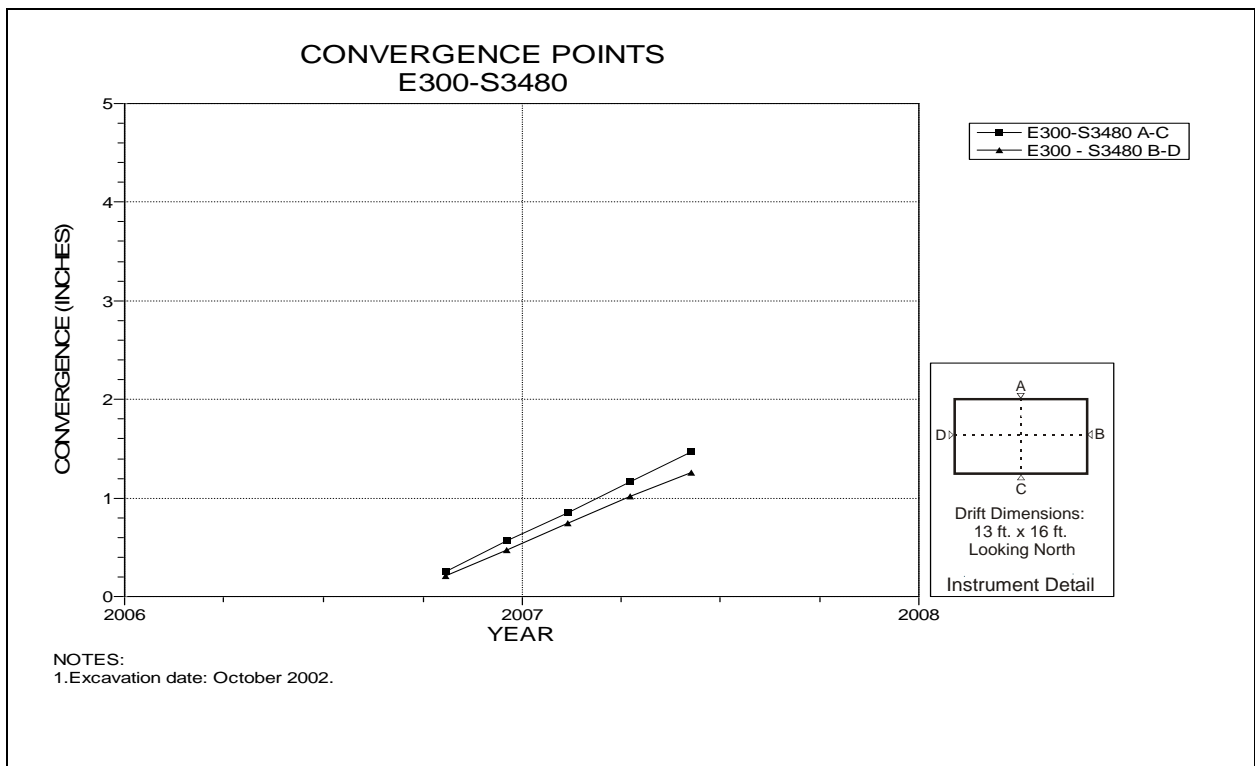


Figure 4-66 Convergence Point Array  
E300 Drift at S3480 – All Chords

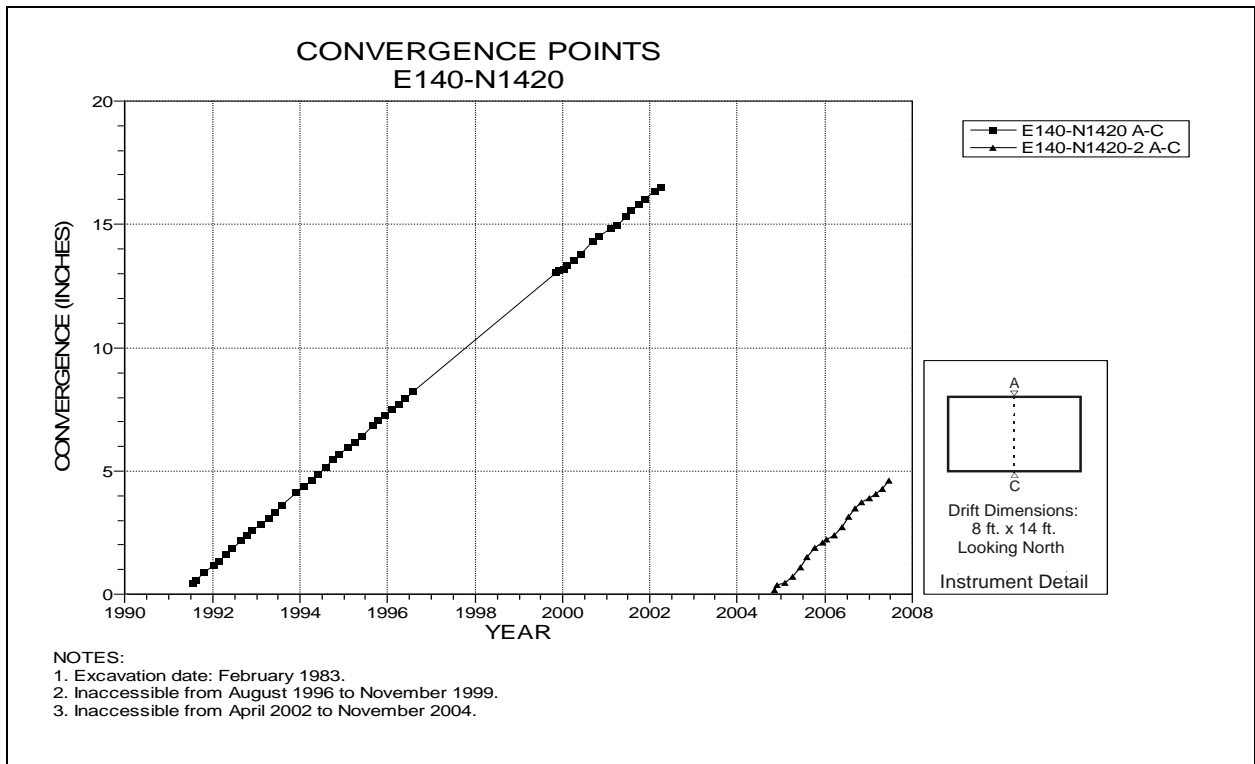


Figure 4-67 Convergence Point Array  
E140 Drift at N1420 Drift Intersection – Roof to Floor

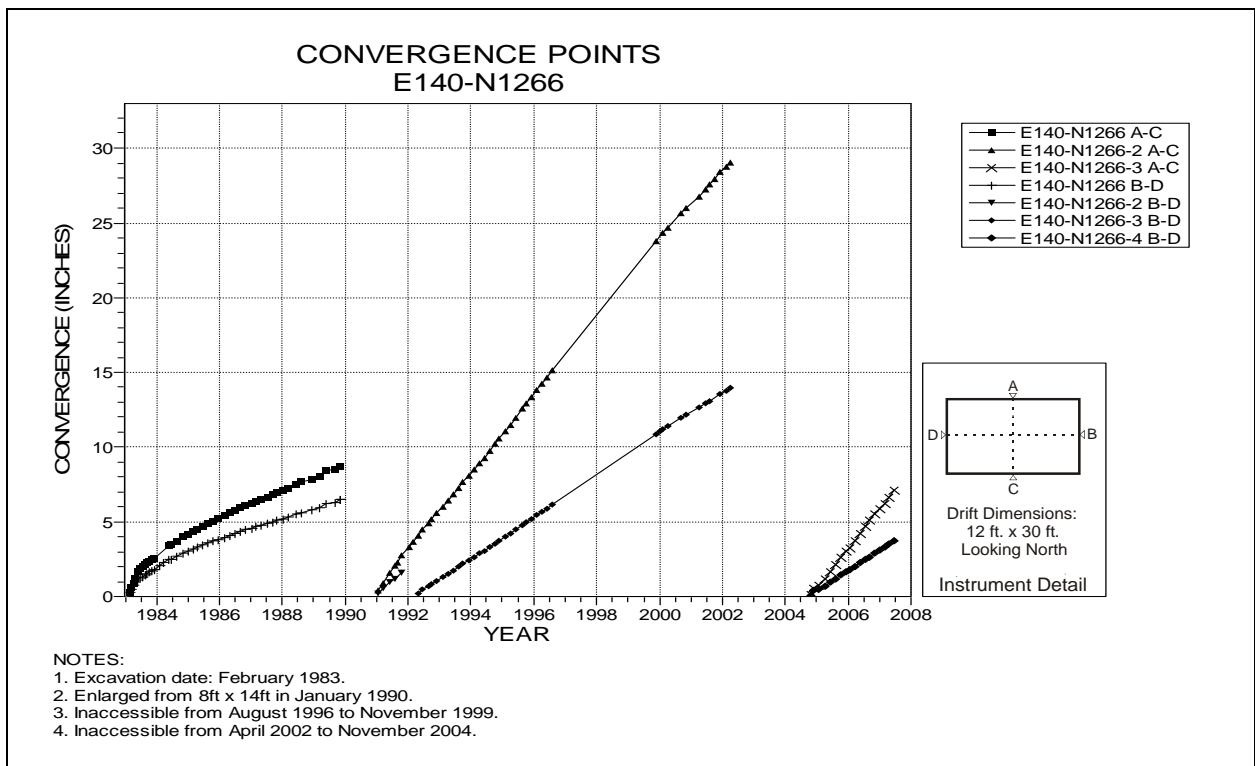


Figure 4-68 Convergence Point Array  
E140 Drift at N1266 – All Chords

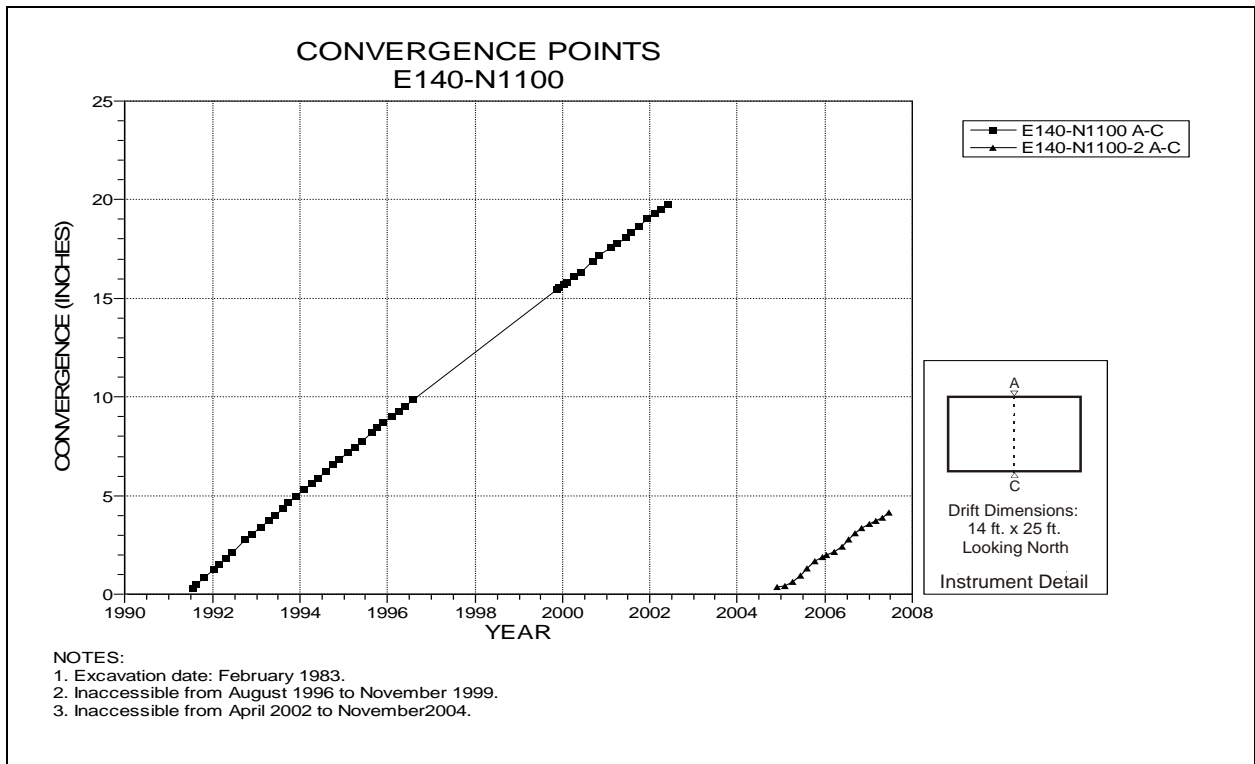


Figure 4-69 Convergence Point Array  
E140 Drift at N1100 Drift Intersection – Roof to Floor

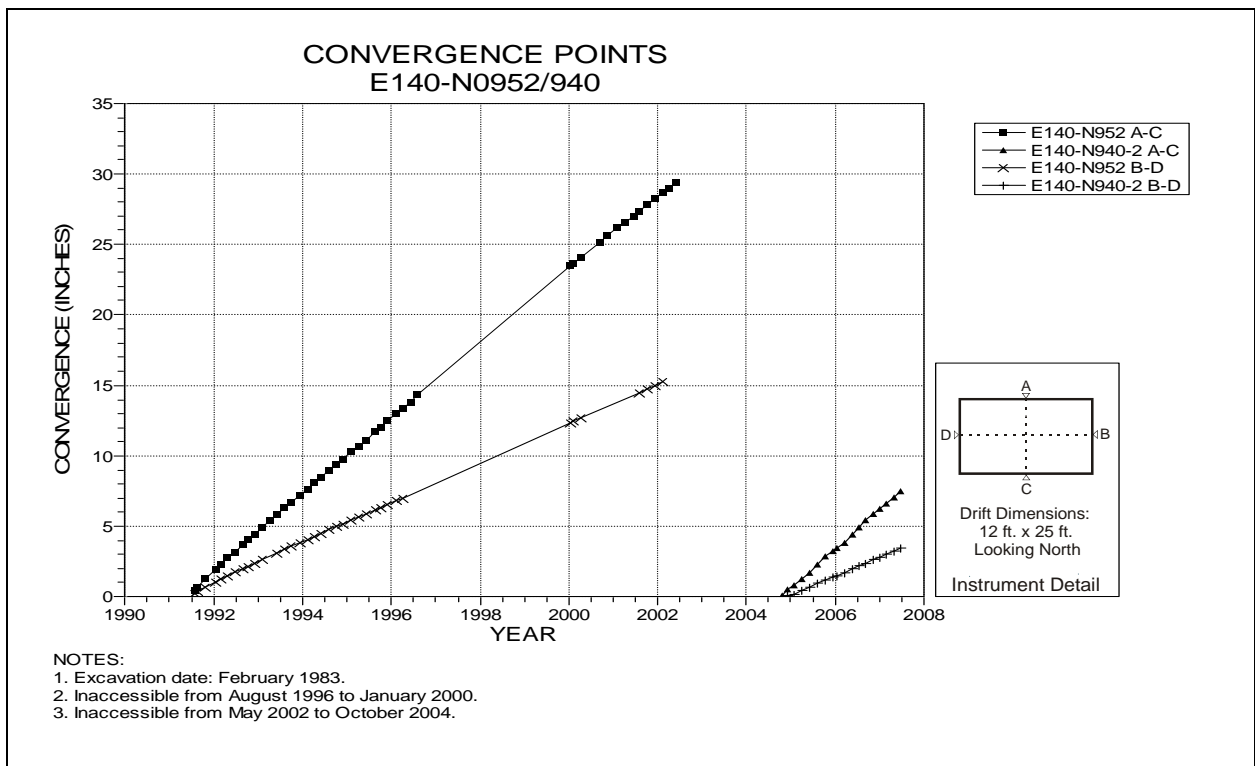


Figure 4-70 Convergence Point Array  
E140 Drift at N940 – All Chords

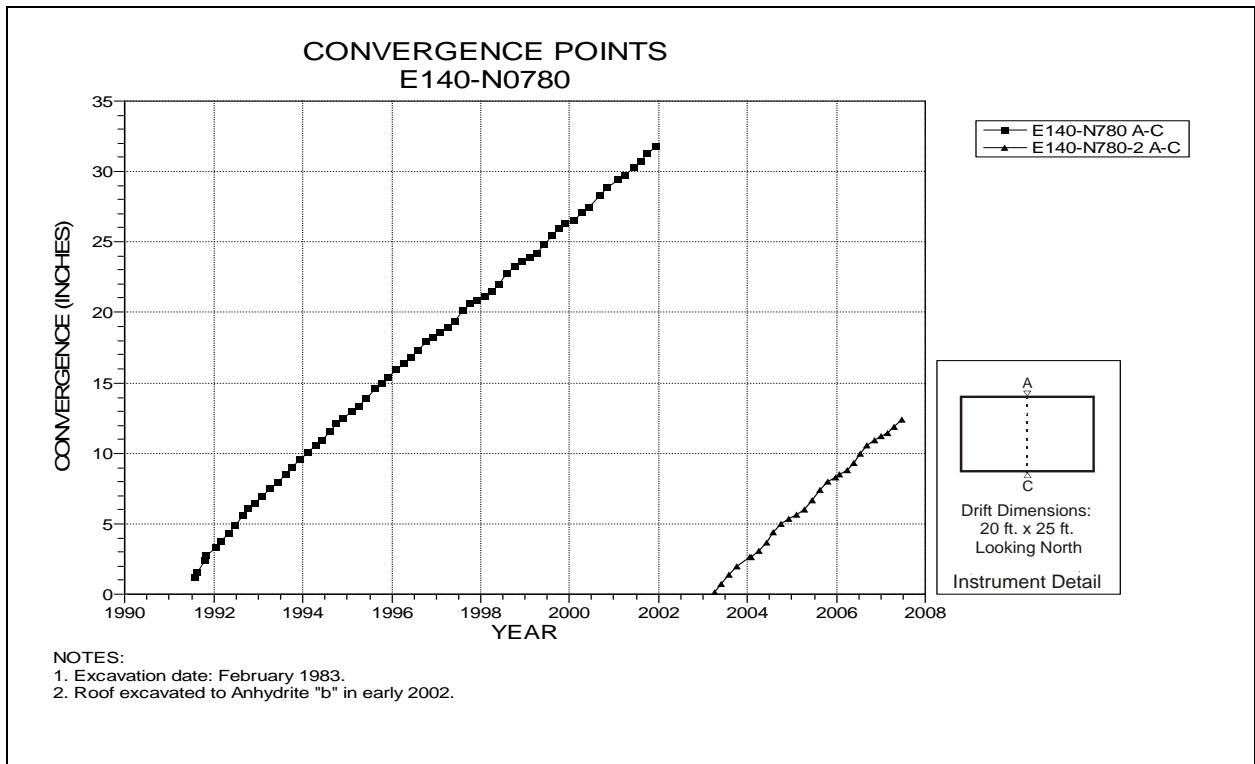


Figure 4-71 Convergence Point Array  
E140 Drift at N780 Drift Intersection – Roof to Floor

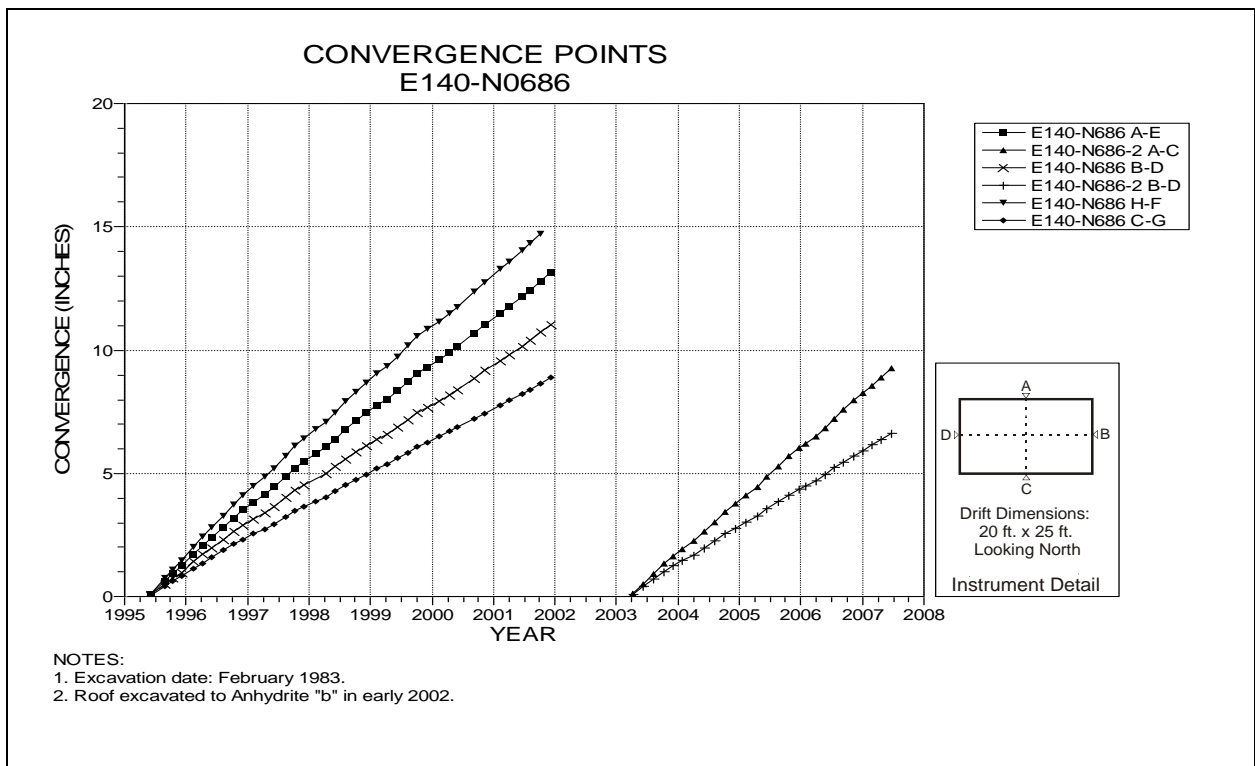


Figure 4-72 Convergence Point Array  
E140 Drift at N686 – All Chords



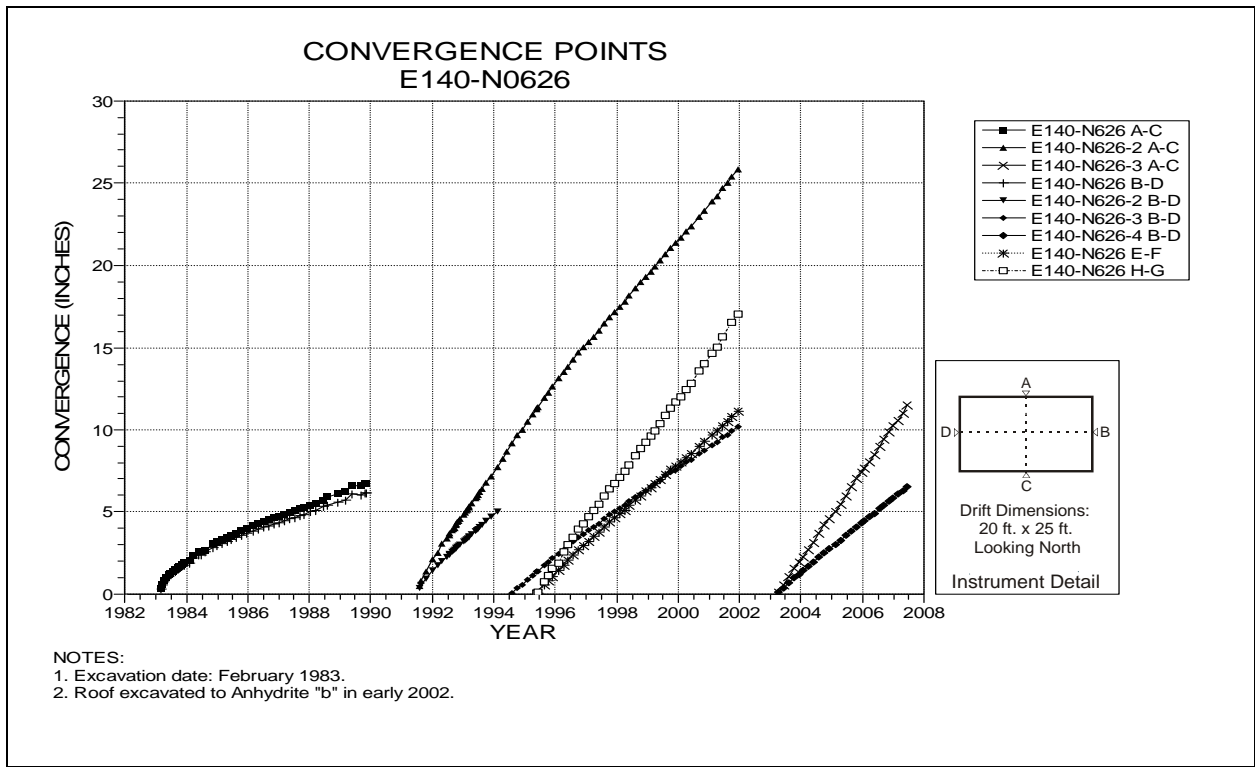


Figure 4-73 Convergence Point Array  
E140 Drift at N626 – All Chords

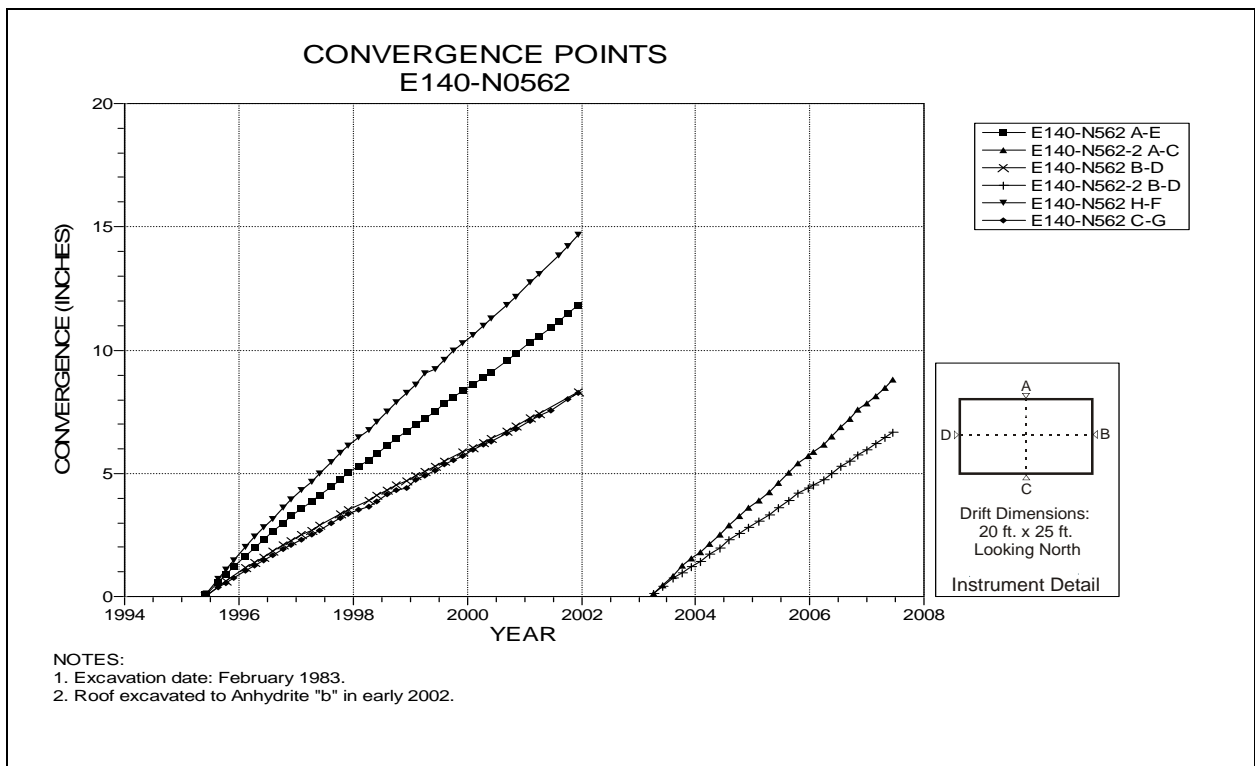


Figure 4-74 Convergence Point Array  
E140 Drift at N562 – All Chords

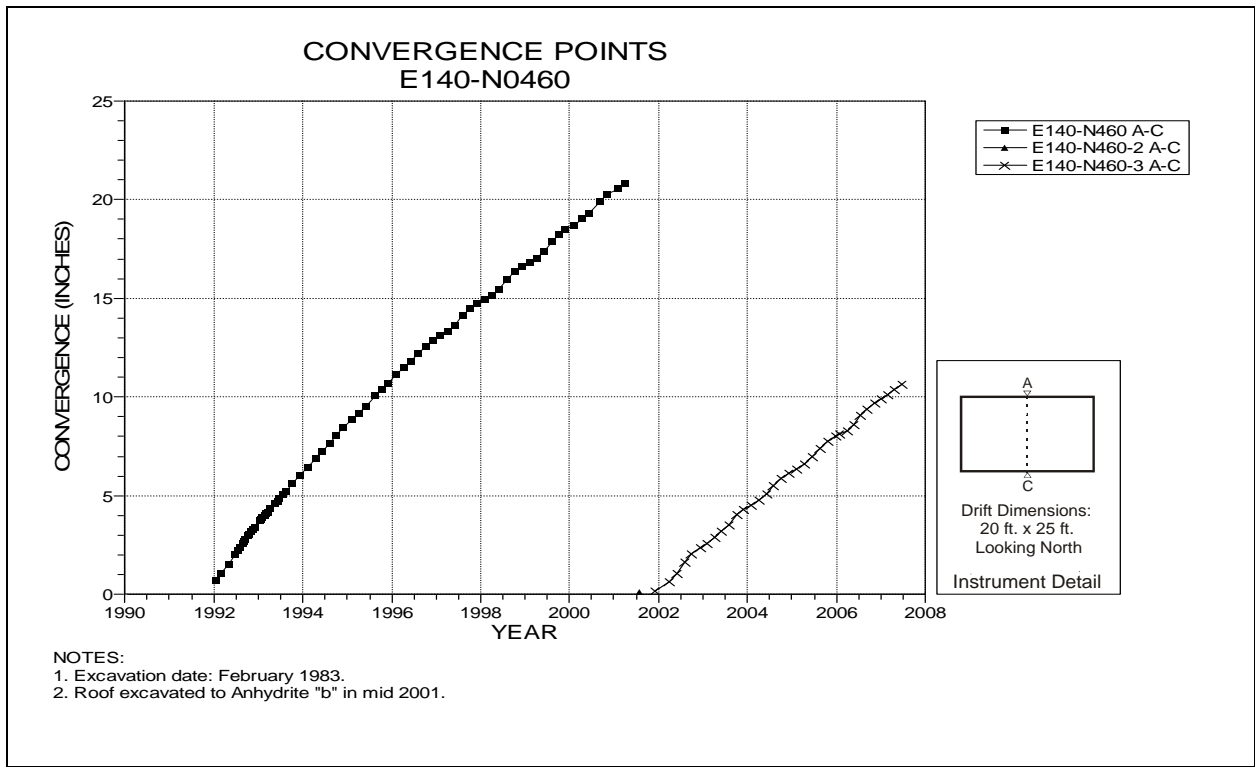


Figure 4-75 Convergence Point Array  
E140 Drift at N460 Drift Intersection – Roof to Floor

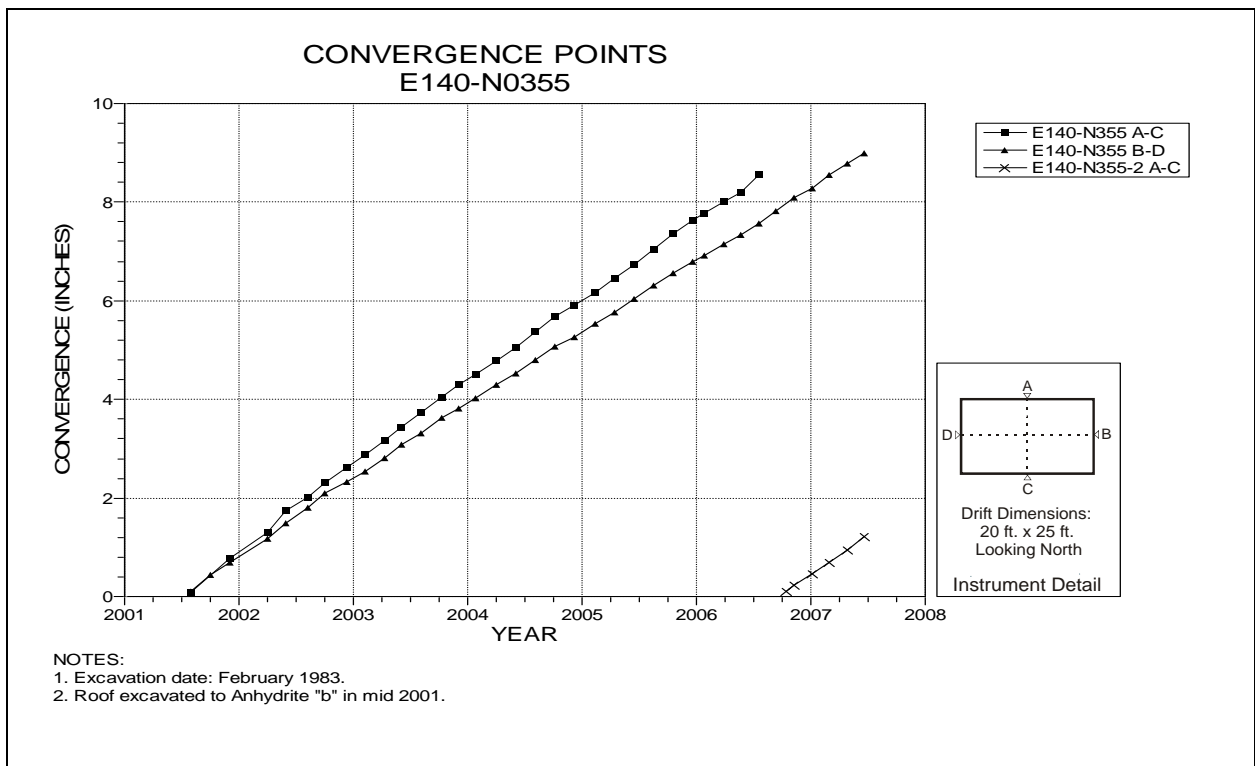


Figure 4-76 Convergence Point Array  
E140 Drift at N355 – All Chords

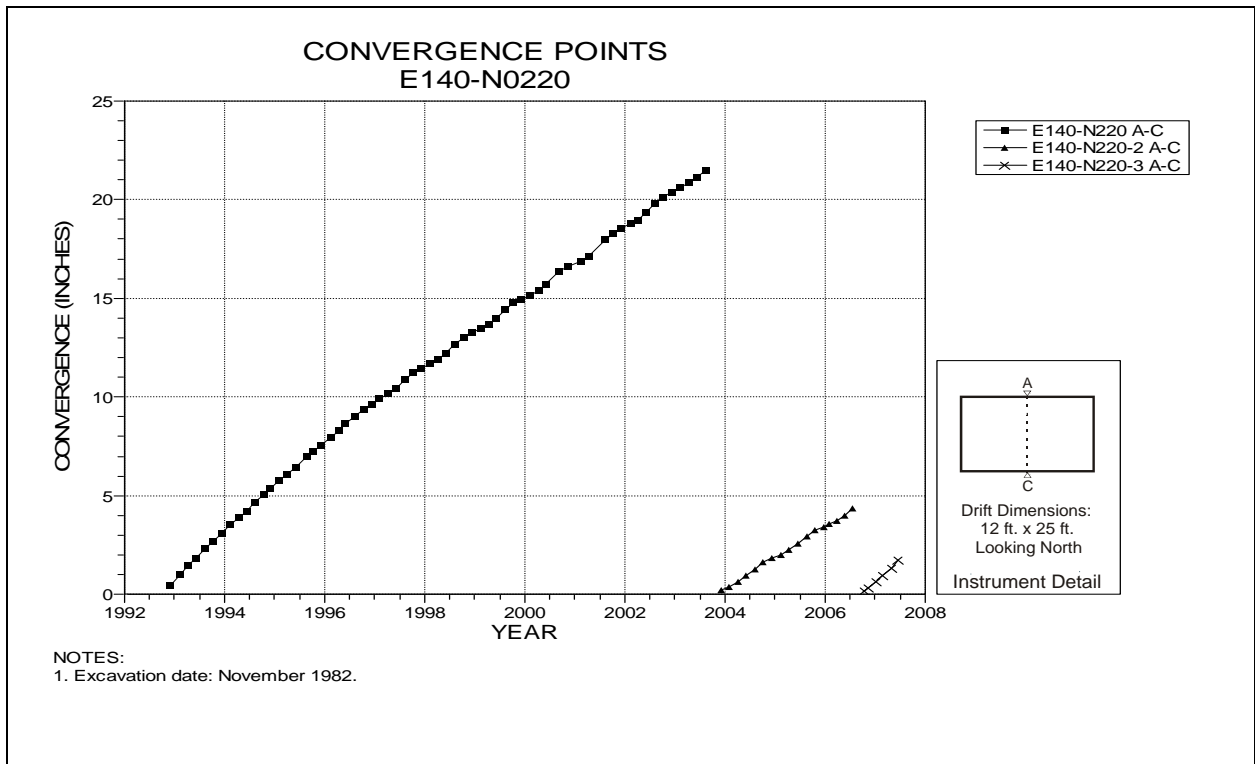


Figure 4-77 Convergence Point Array  
E140 Drift at N220 – Roof to Floor

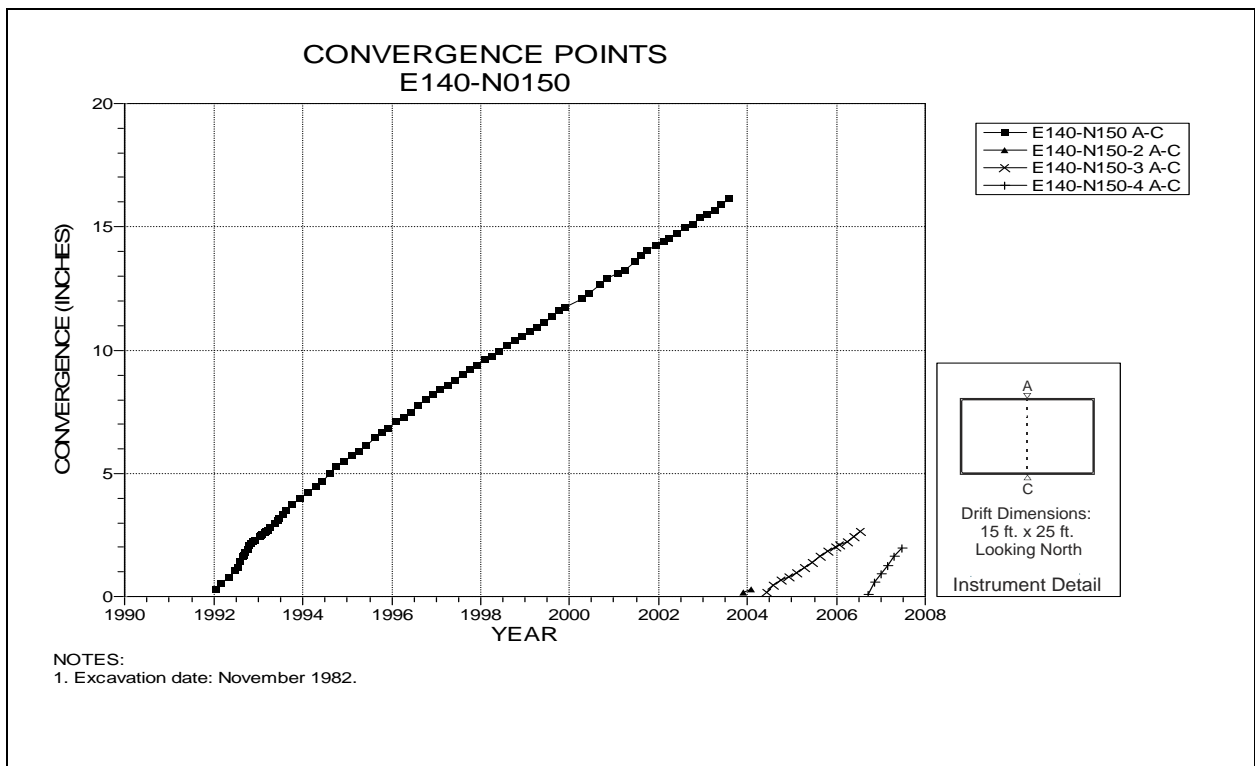


Figure 4-78 Convergence Point Array  
E140 Drift at N150 Drift Intersection – Roof to Floor

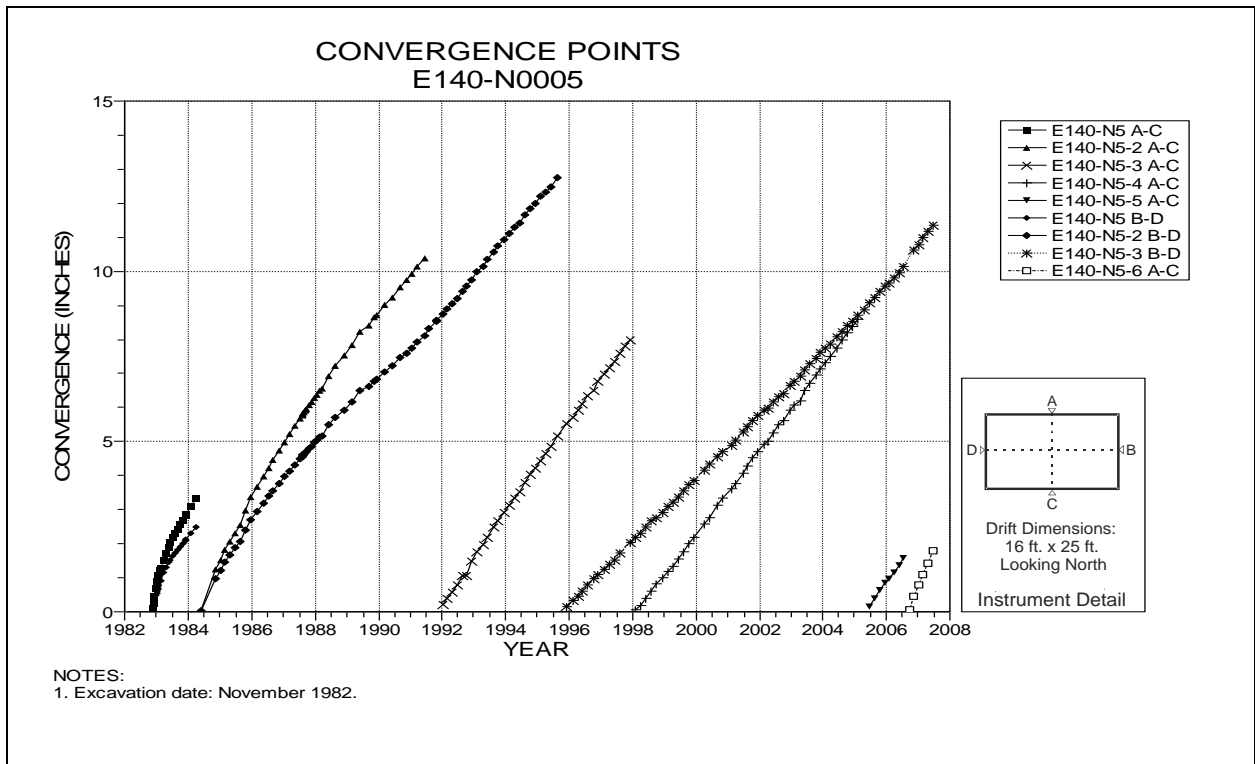


Figure 4-79 Convergence Point Array  
E140 Drift at N5 – All Chords

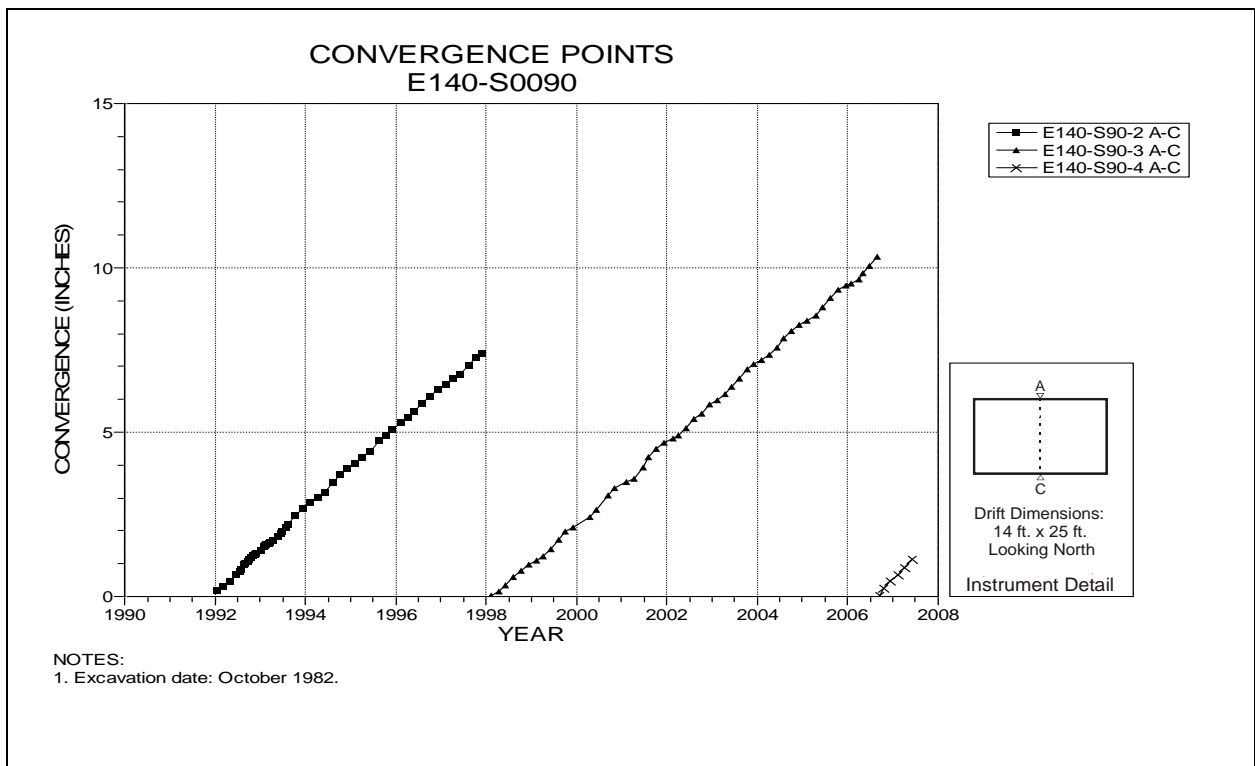


Figure 4-80 Convergence Point Array  
E140 Drift at S90 Drift Intersection – Roof to Floor

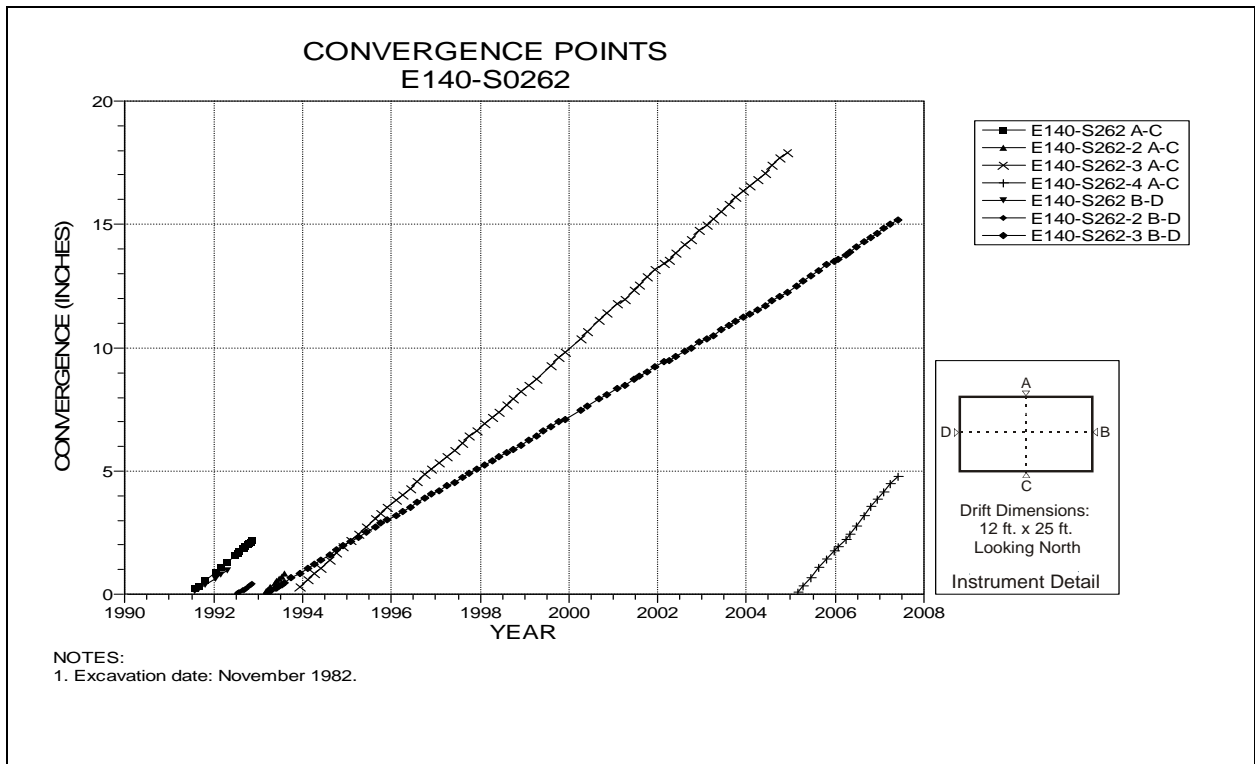


Figure 4-81 Convergence Point Array  
E140 Drift at S262 – All Chords

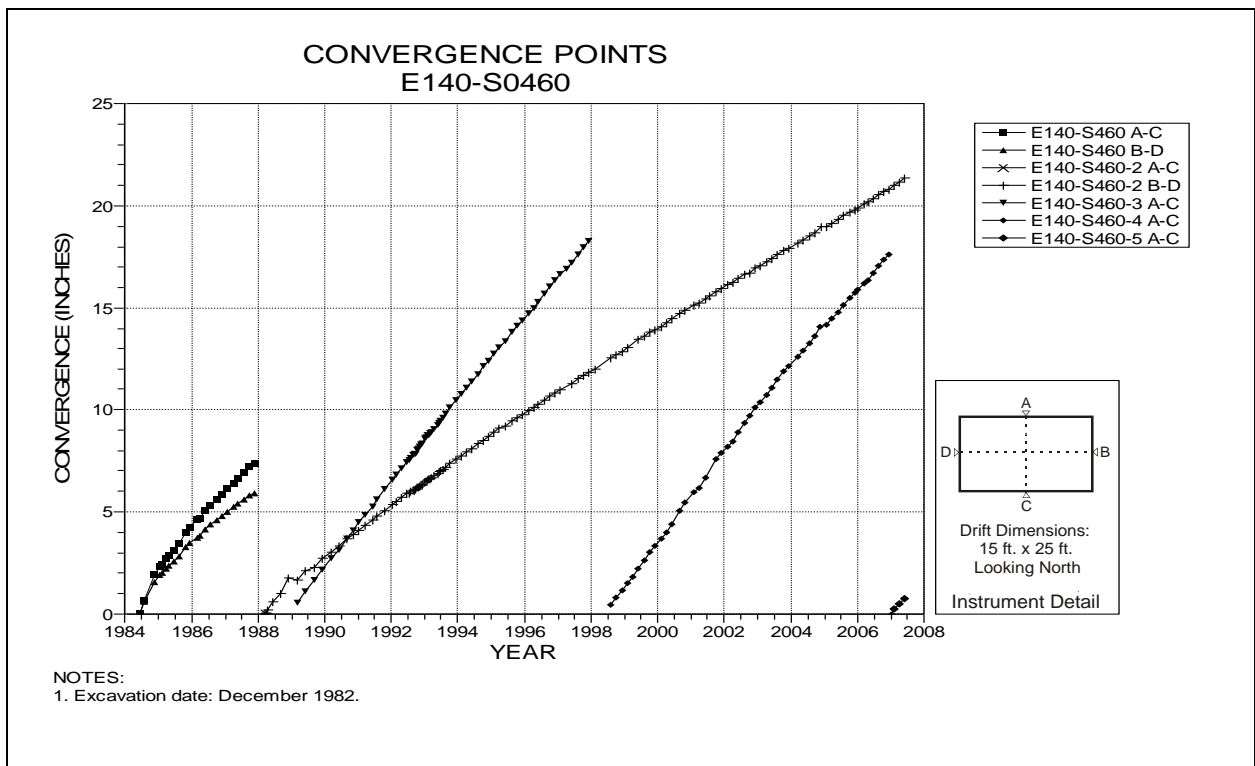


Figure 4-82 Convergence Point Array  
E140 Drift at S460 – All Chords

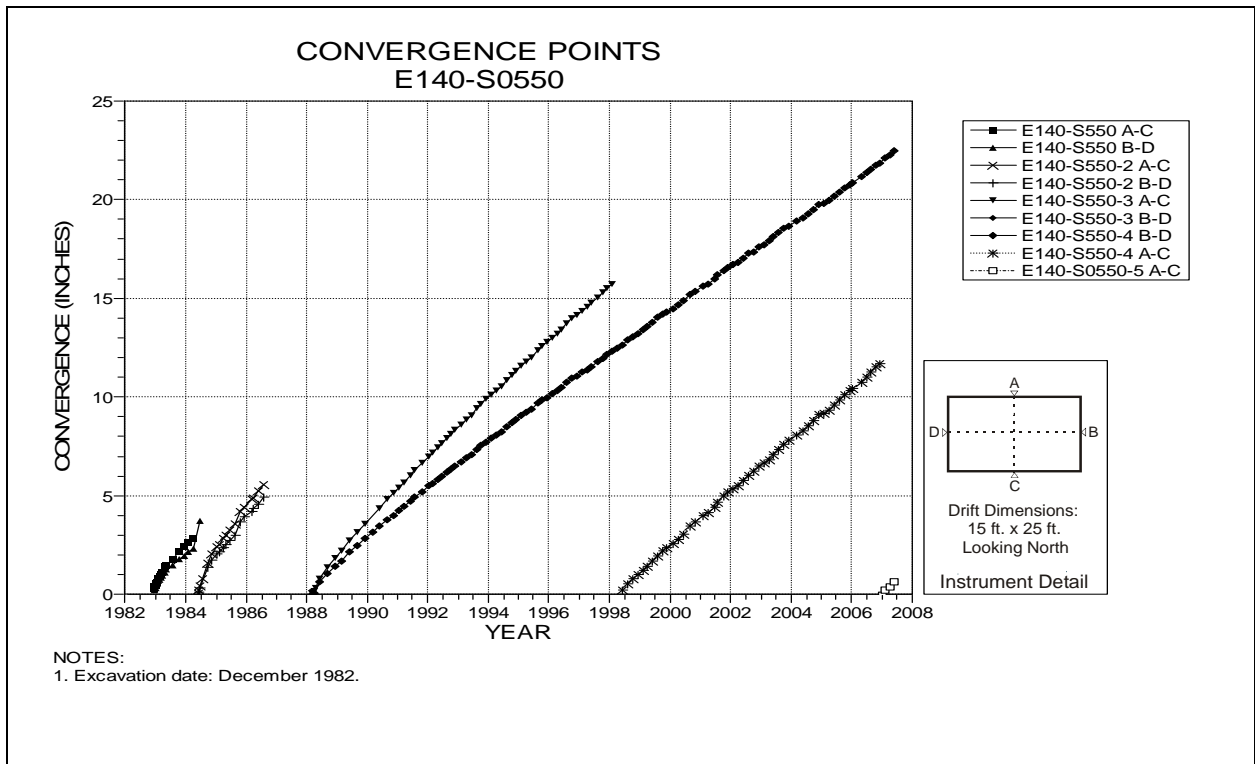


Figure 4-83 Convergence Point Array  
E140 Drift at S550 – All Chords

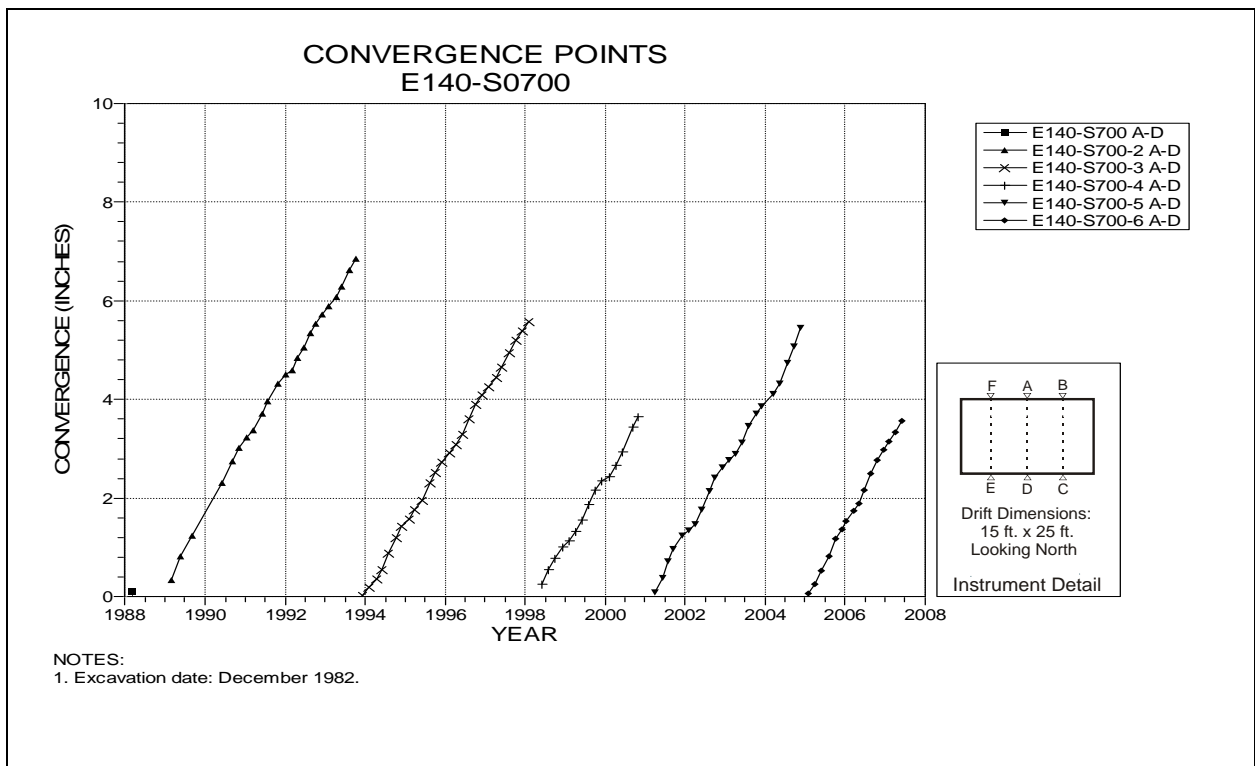


Figure 4-84 Convergence Point Array  
E140 Drift at S700 Drift Intersection – Roof to Floor Centerline

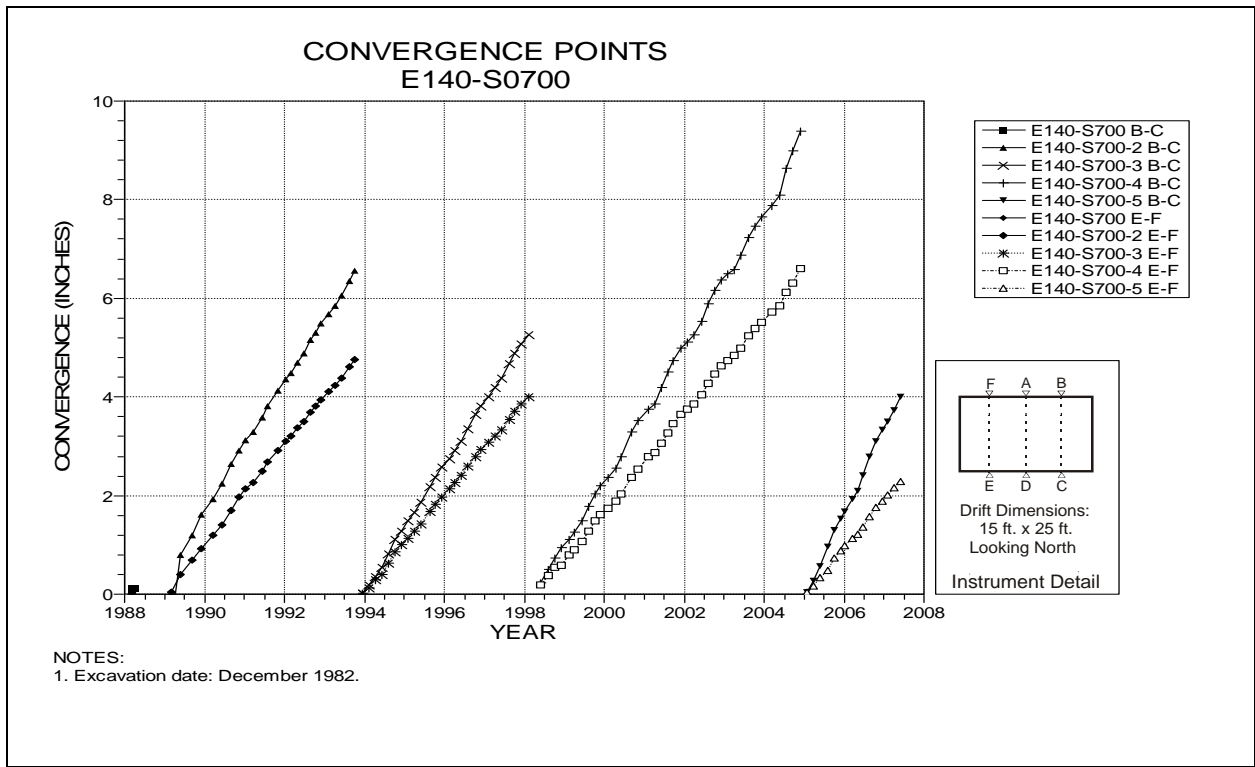


Figure 4-85 Convergence Point Array  
E140 Drift at S700 Drift Intersection – Roof to Floor Quarter Points

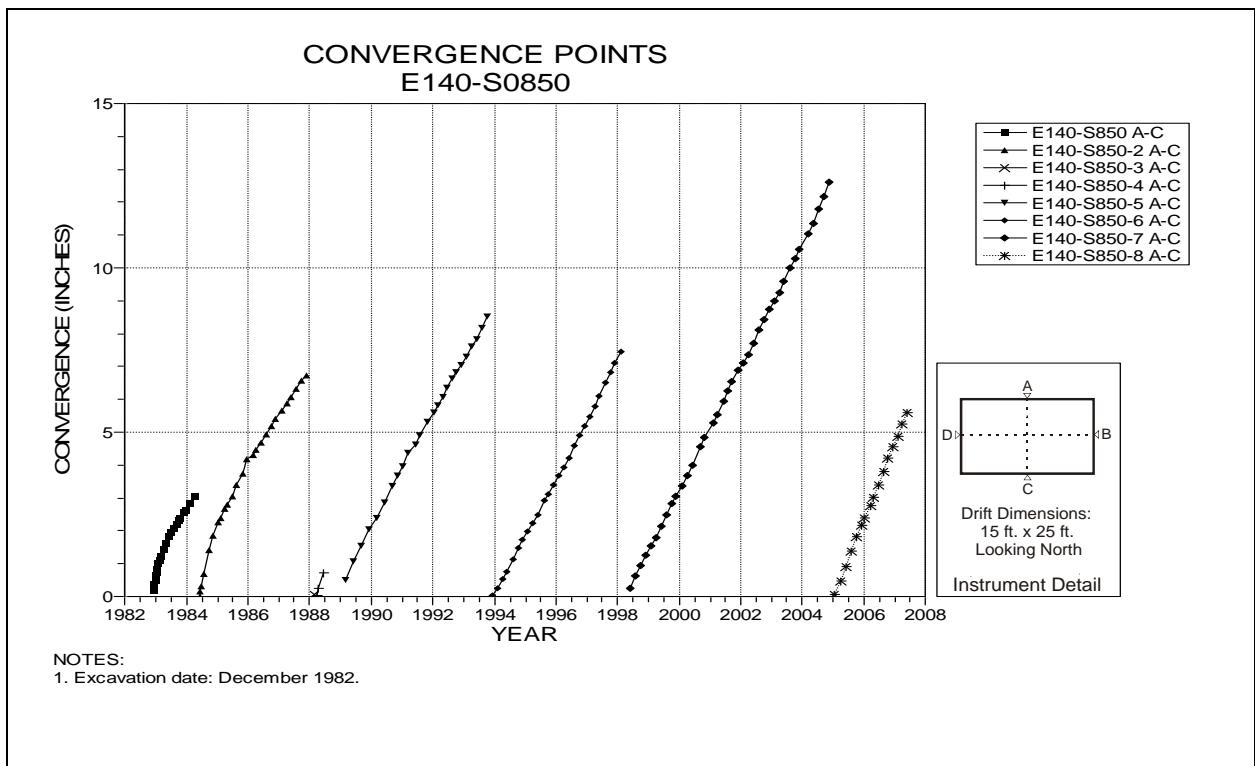


Figure 4-86 Convergence Point Array  
E140 Drift at S850 – Roof to Floor

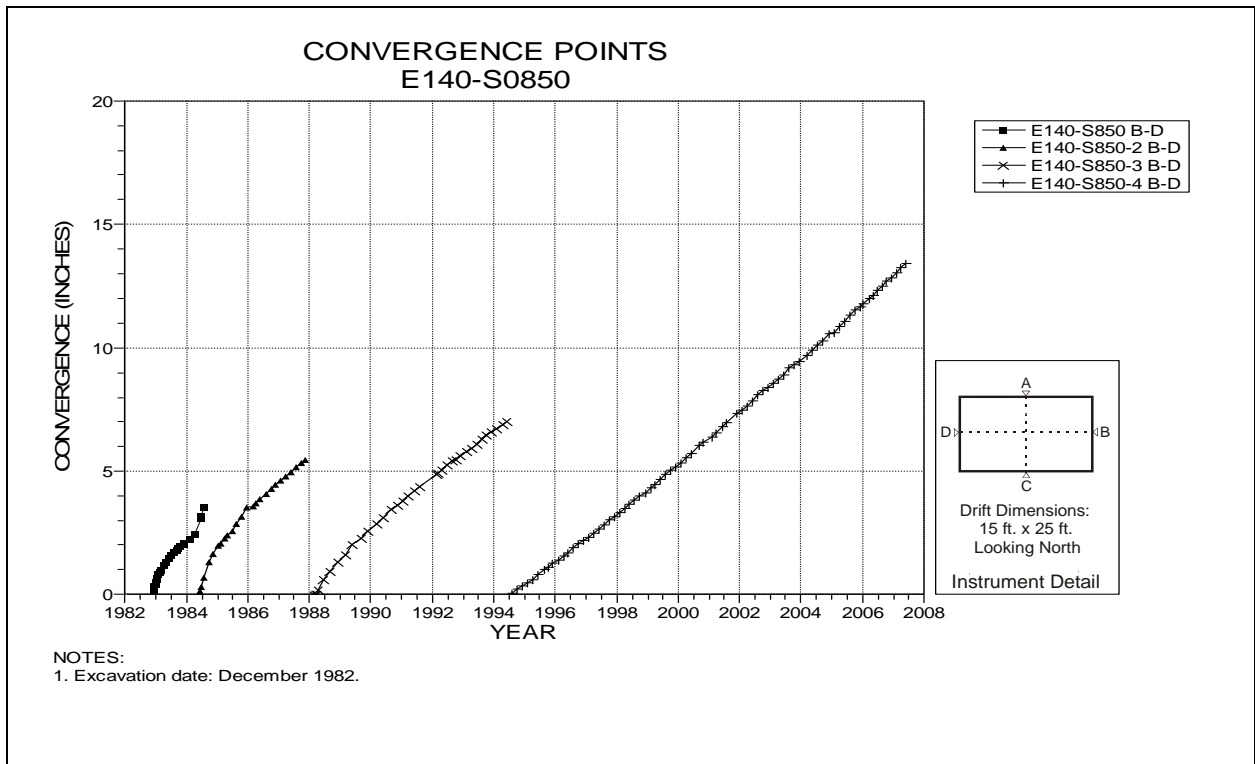


Figure 4-87 Convergence Point Array  
E140 Drift at S850 – Rib to Rib

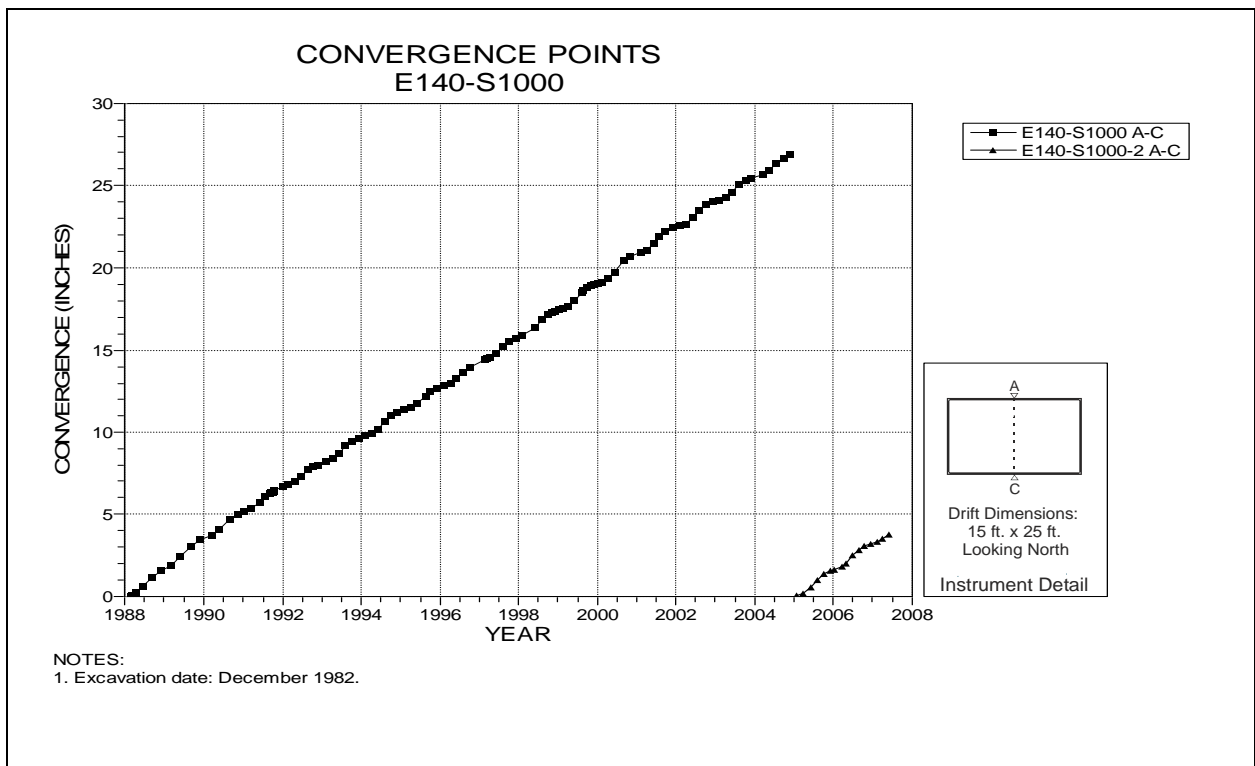


Figure 4-88 Convergence Point Array  
E140 Drift at S1000 Drift Intersection – Roof to Floor



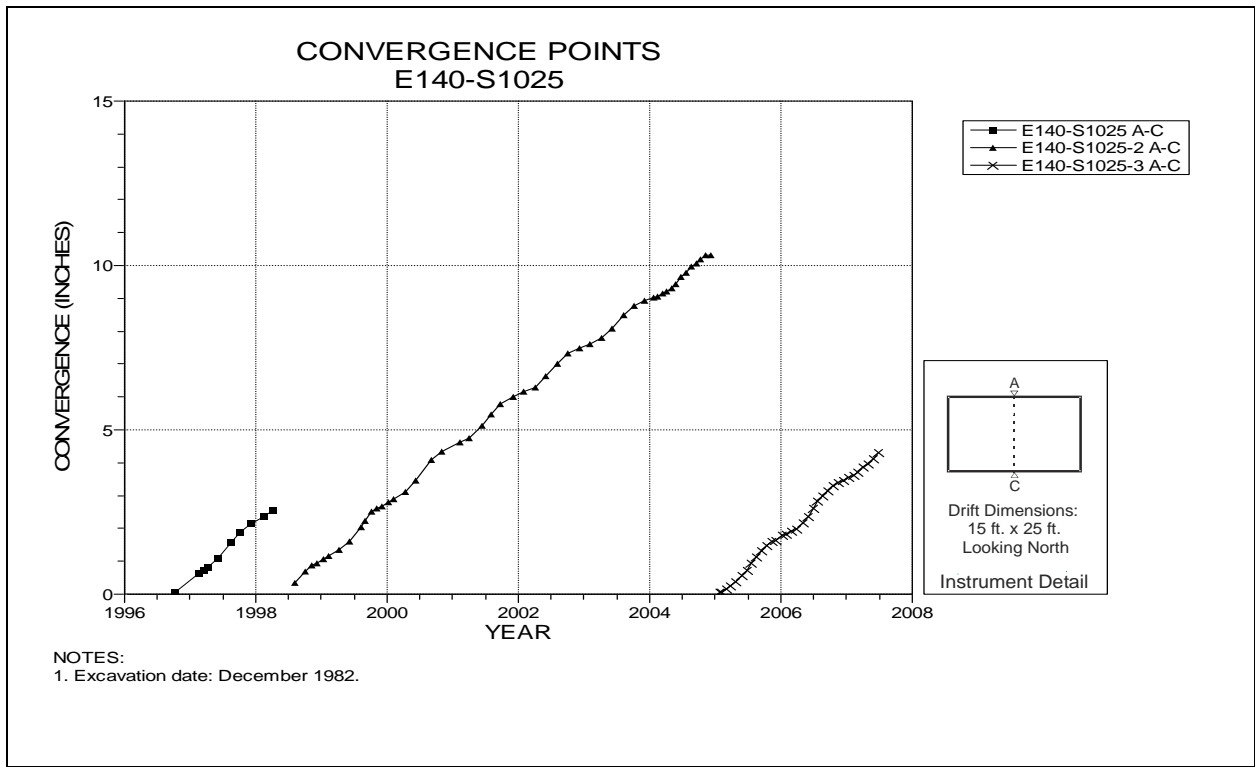


Figure 4-89 Convergence Point Array  
E140 Drift at S1025 – Roof to Floor

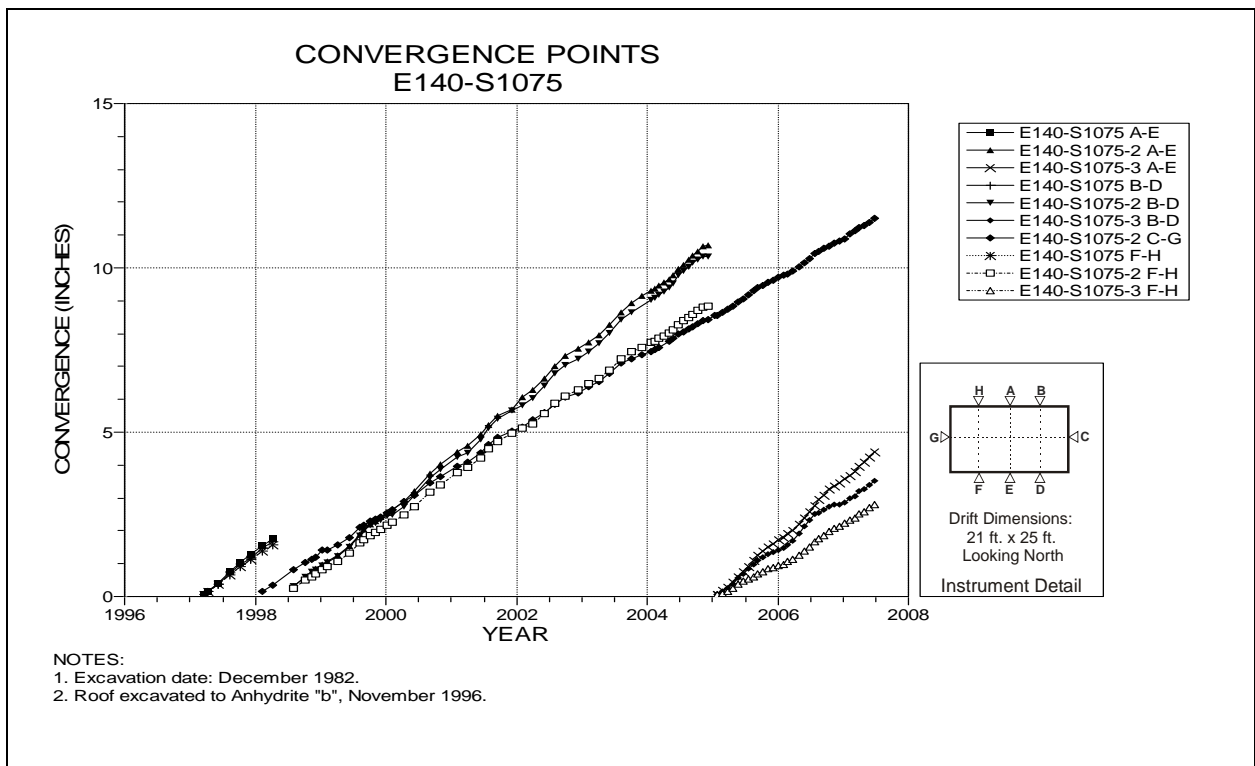


Figure 4-90 Convergence Point Array  
E140 Drift at S1075 – All Chords

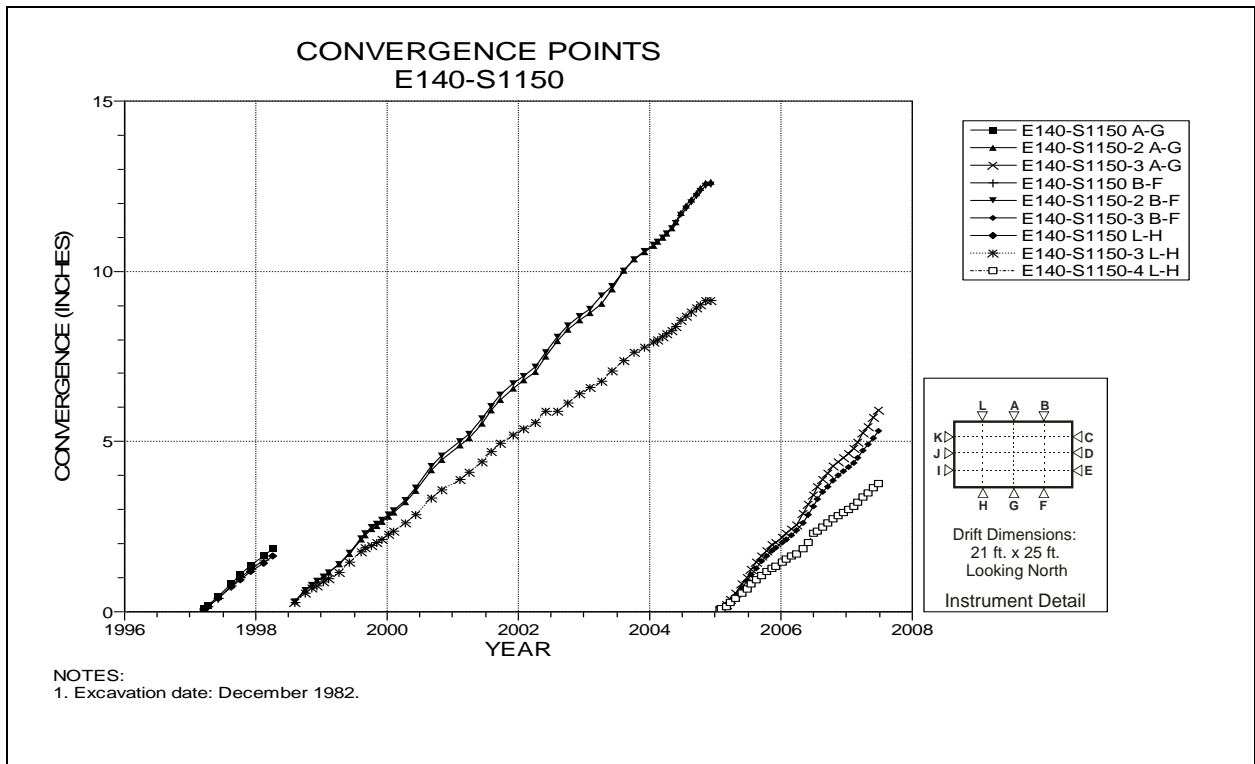


Figure 4-91 Convergence Point Array  
E140 Drift at S1150 – Roof to Floor

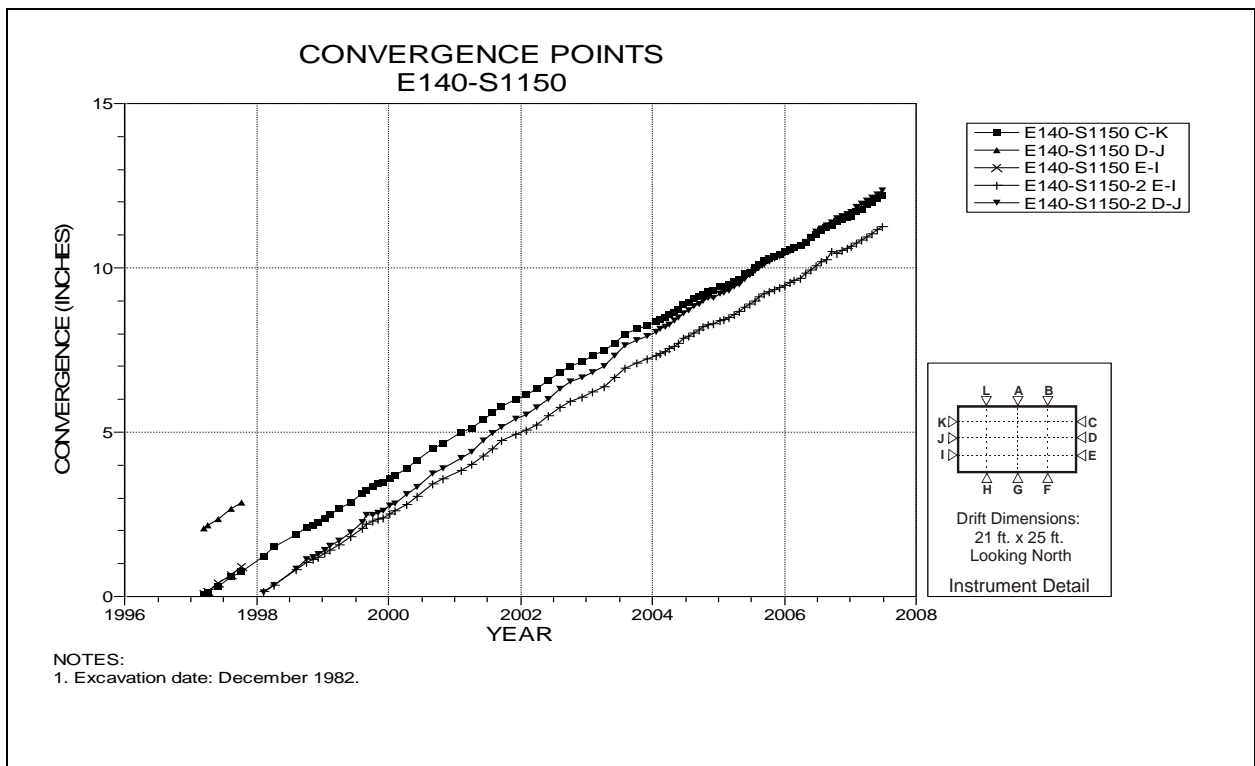


Figure 4-92 Convergence Point Array  
E140 Drift at S1150 – Rib to Rib

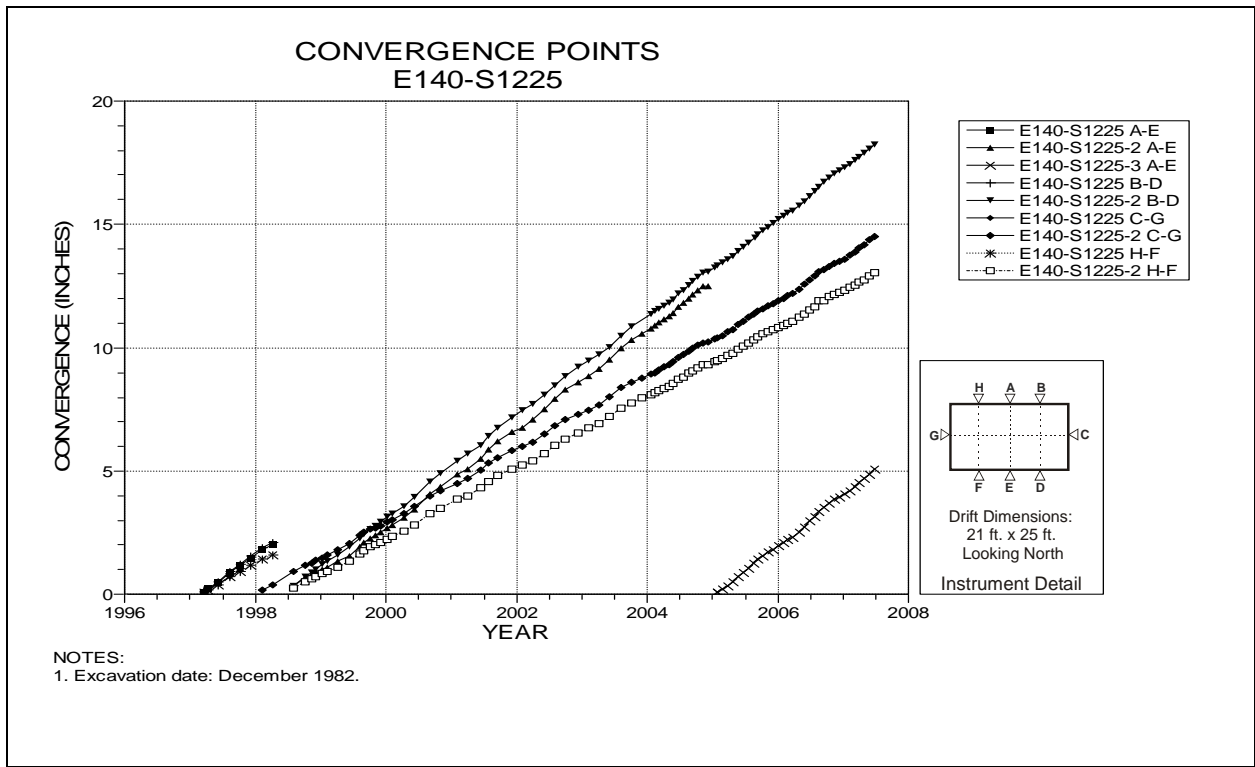


Figure 4-93 Convergence Point Array  
E140 Drift at S1225 – All Chords

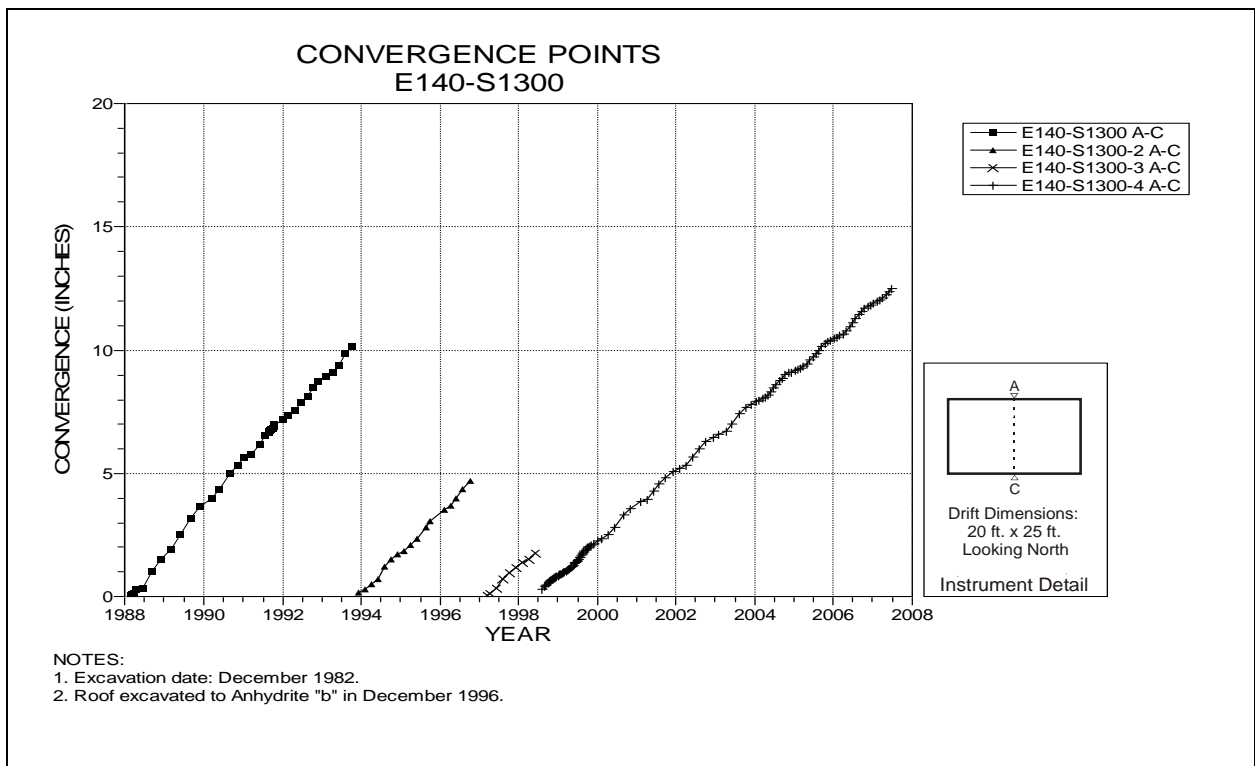


Figure 4-94 Convergence Point Array  
E140 Drift at S1300 Drift Intersection – Roof to Floor

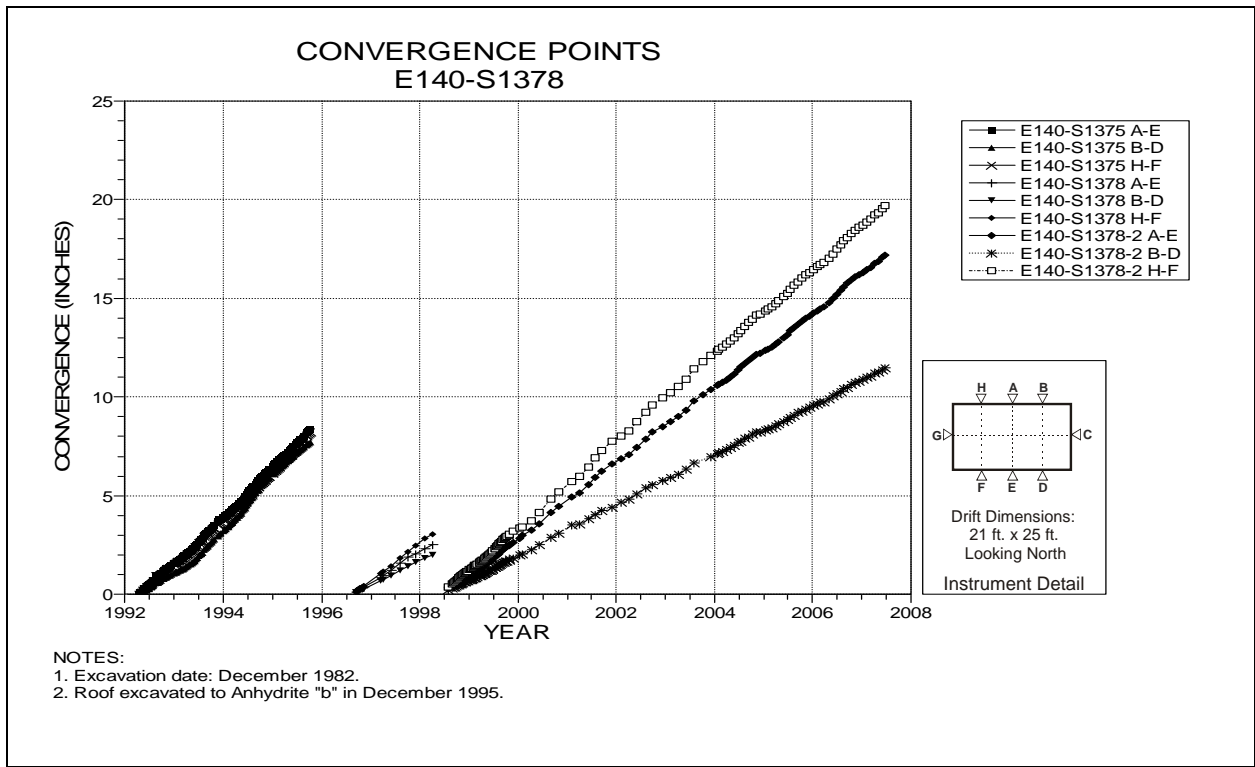


Figure 4-95 Convergence Point Array  
E140 Drift at S1378 – Roof to Floor

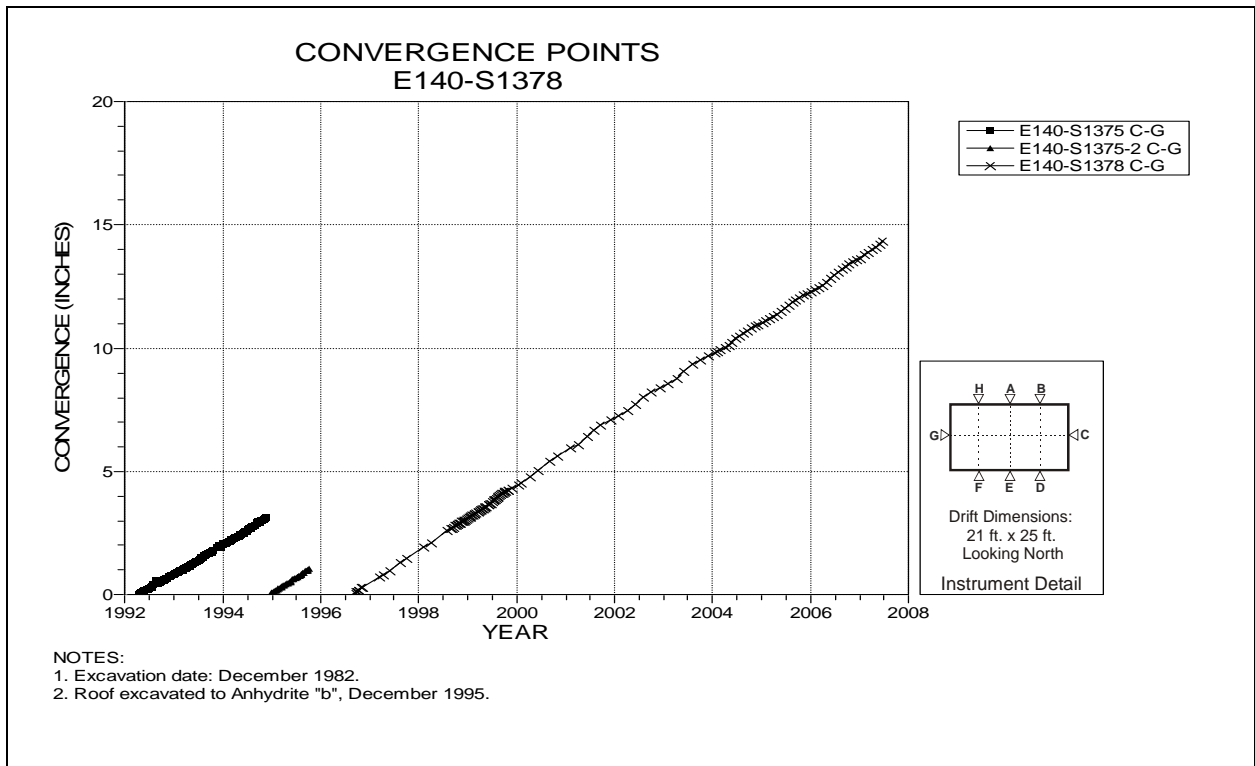


Figure 4-96 Convergence Point Array  
E140 Drift at S1378 – Rib to Rib

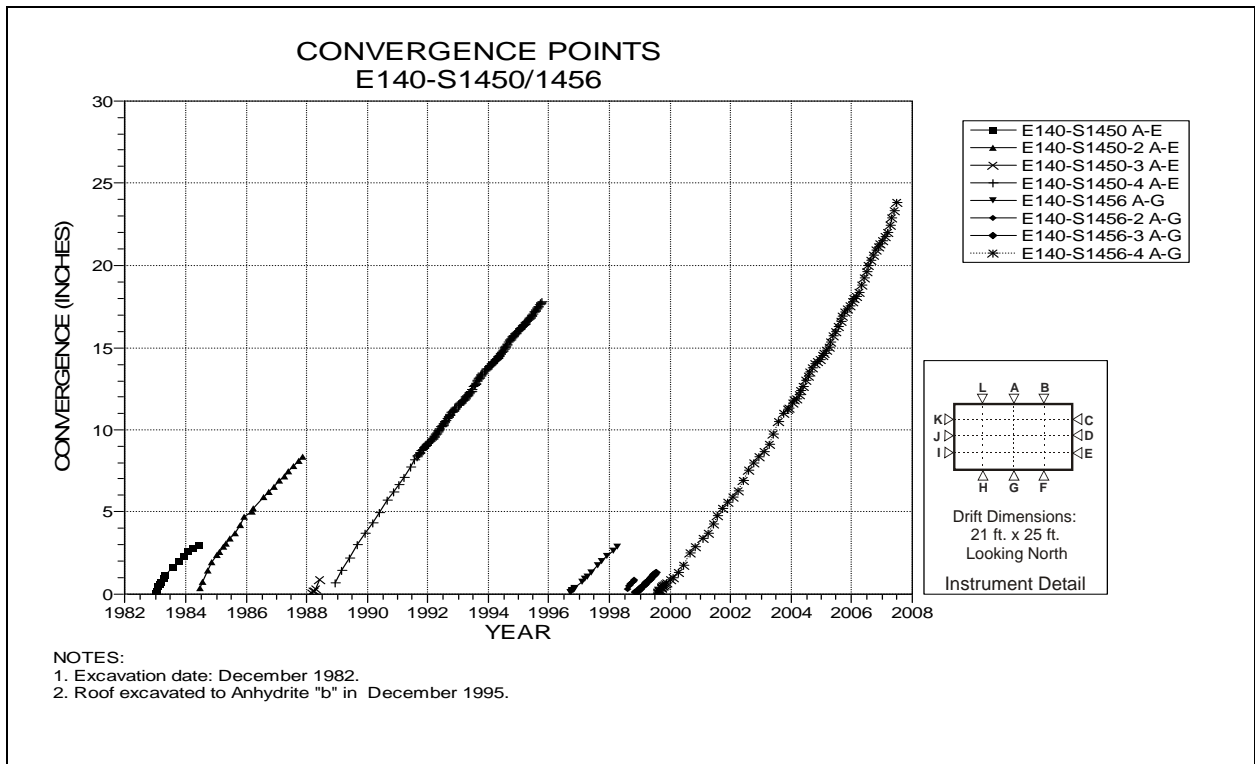


Figure 4-97 Convergence Point Array  
E140 Drift at S1450/1456 – Roof to Floor – Centerline

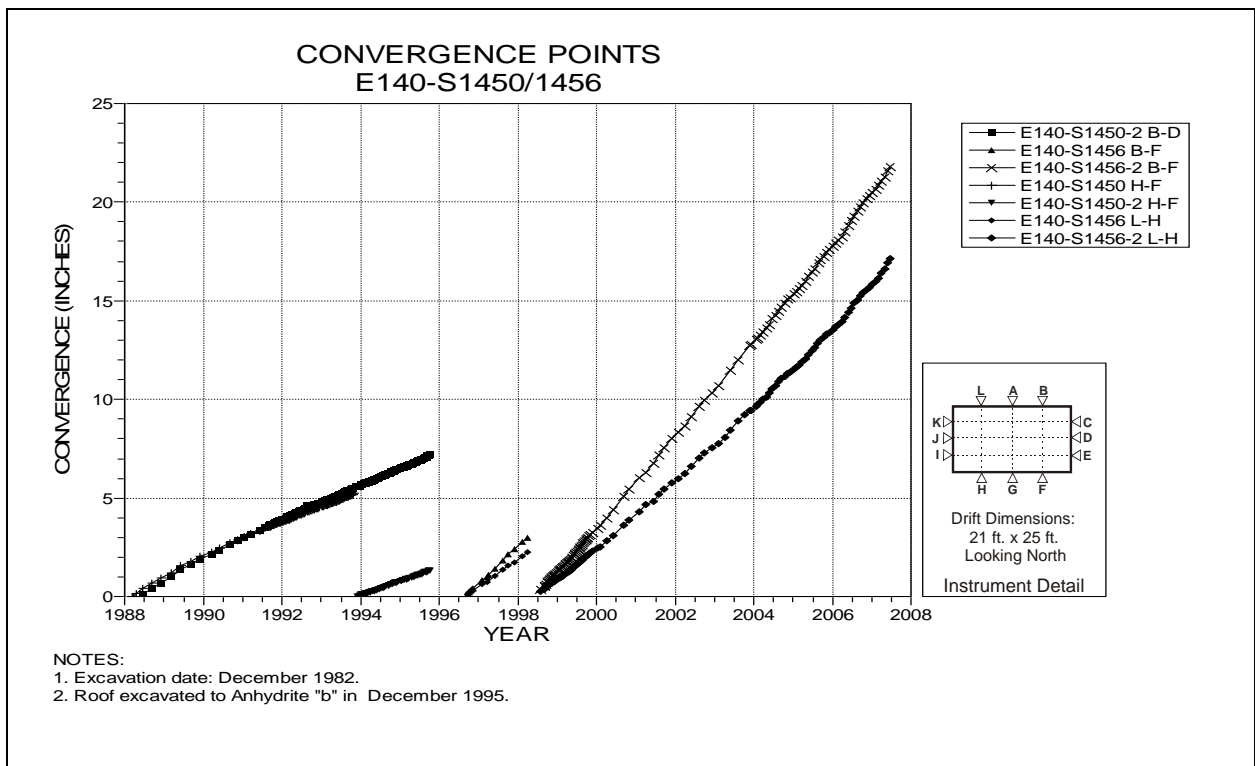


Figure 4-98 Convergence Point Array  
E140 Drift at S1450/S1456 – Roof to Floor – Quarter Points

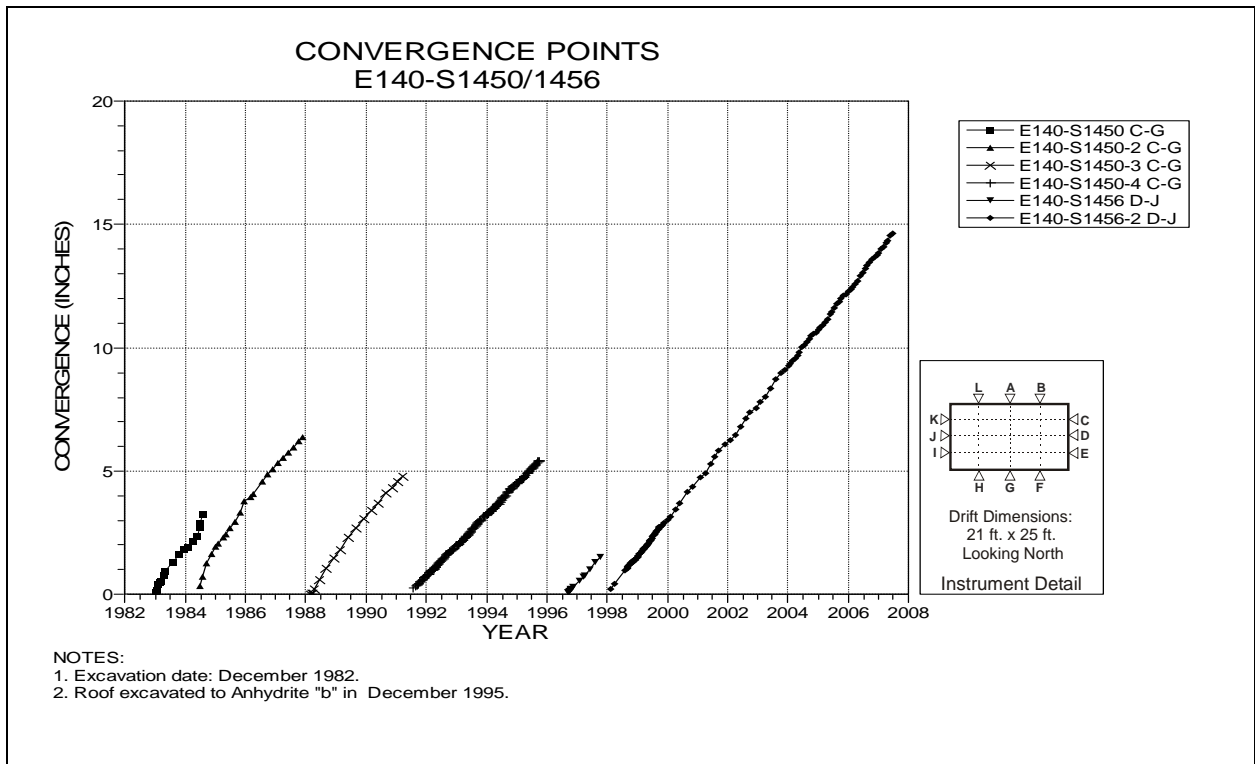


Figure 4-99 Convergence Point Array  
E140 Drift at S1450/S1456 – Rib to Rib – Midheight

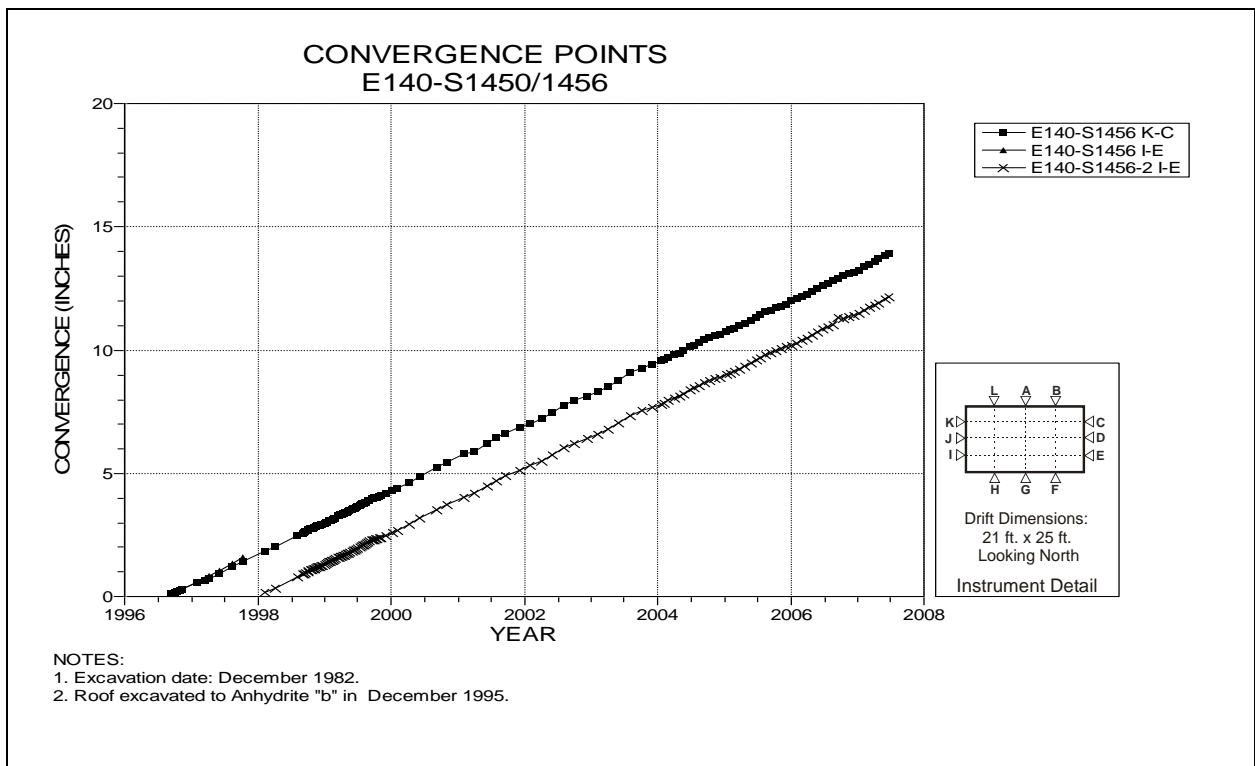


Figure 4-100 Convergence Point Array  
E140 Drift at S1450/S1456 – Rib to Rib – Quarter Points

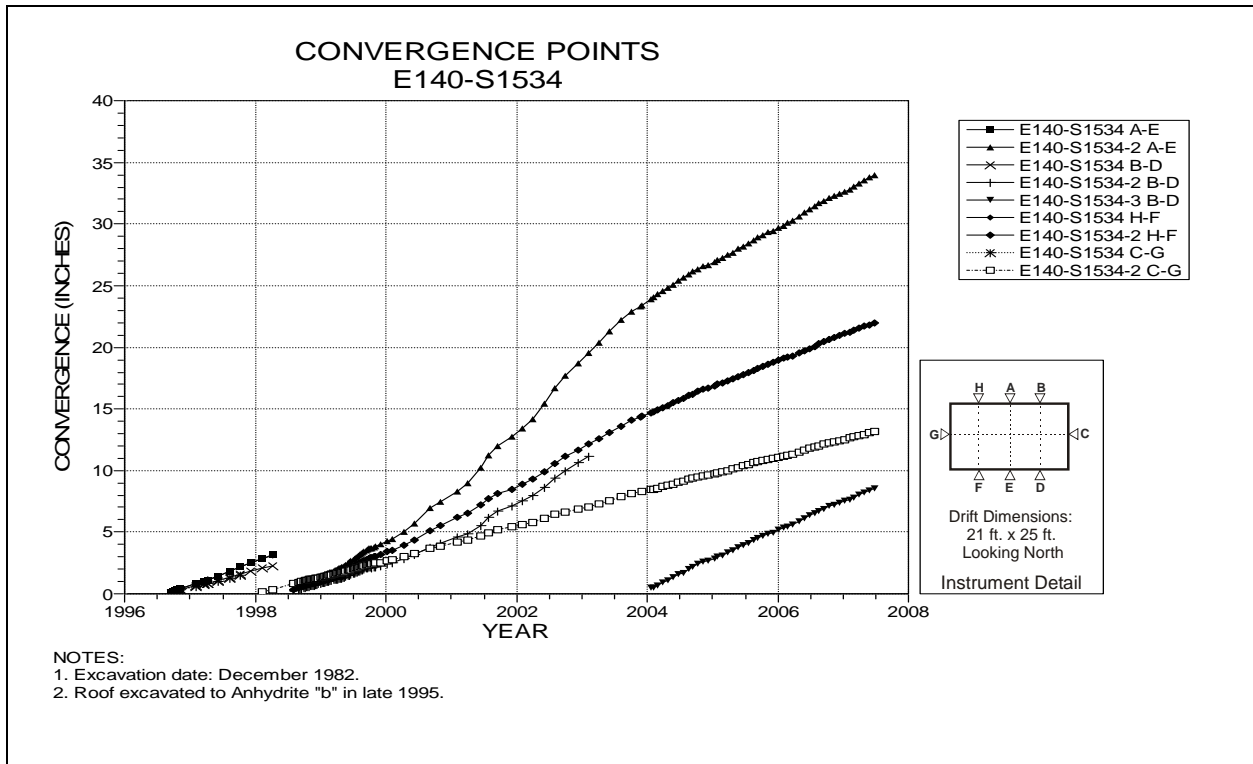


Figure 4-101 Convergence Point Array  
E140 Drift at S1534 – All Chords

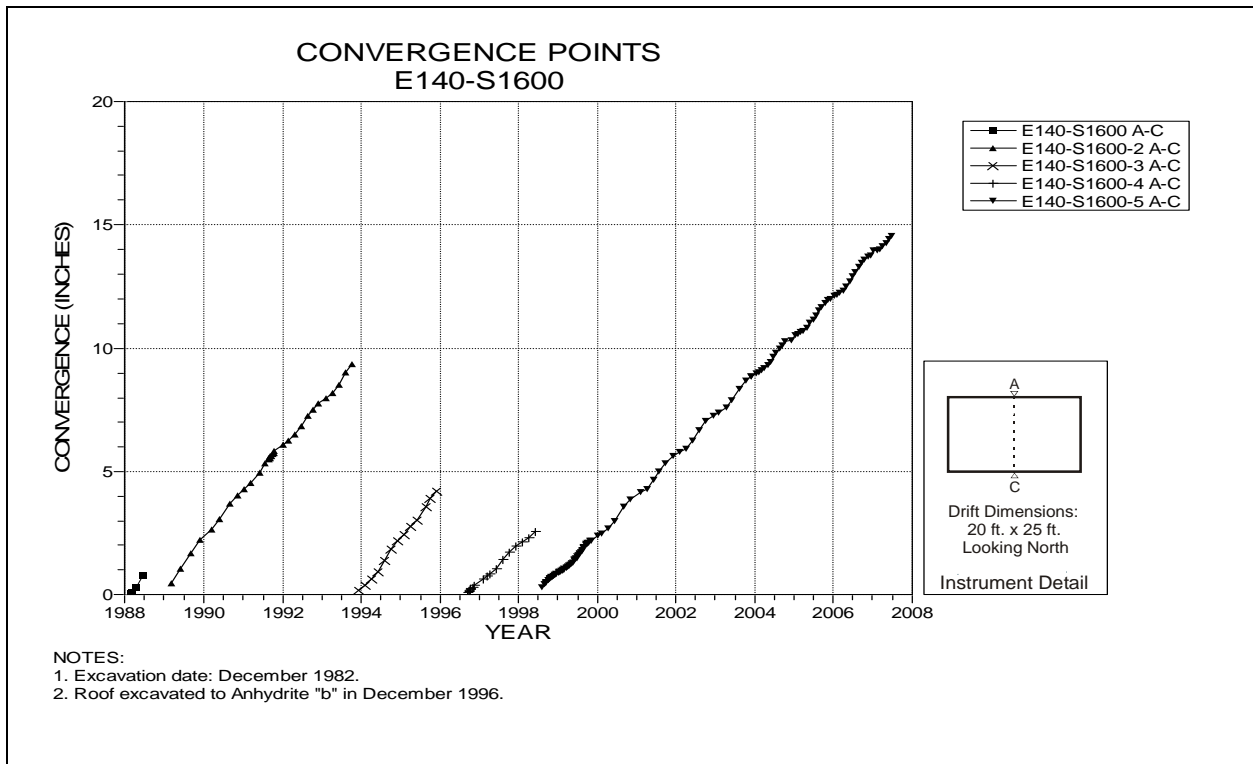


Figure 4-102 Convergence Point Array  
E140 Drift at S1600 Drift Intersection – Roof to Floor

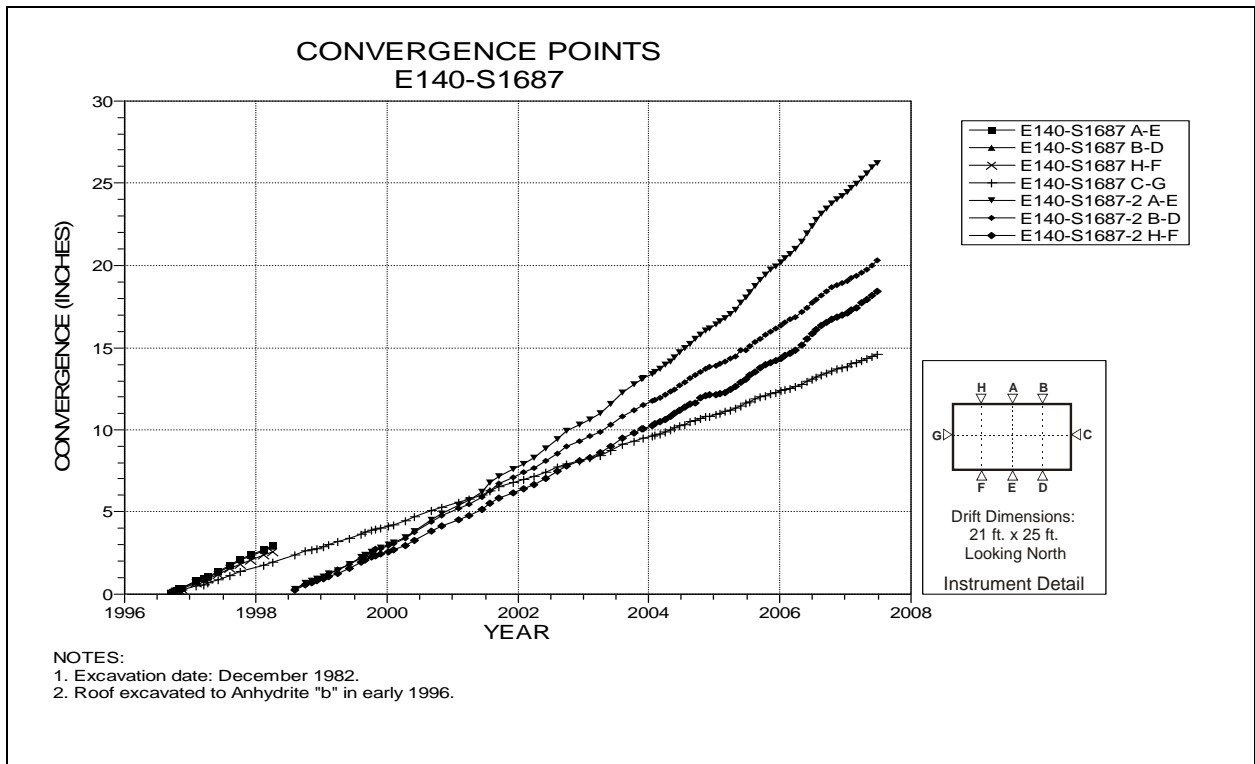


Figure 4-103 Convergence Point Array  
E140 Drift at S1687 – All Chords

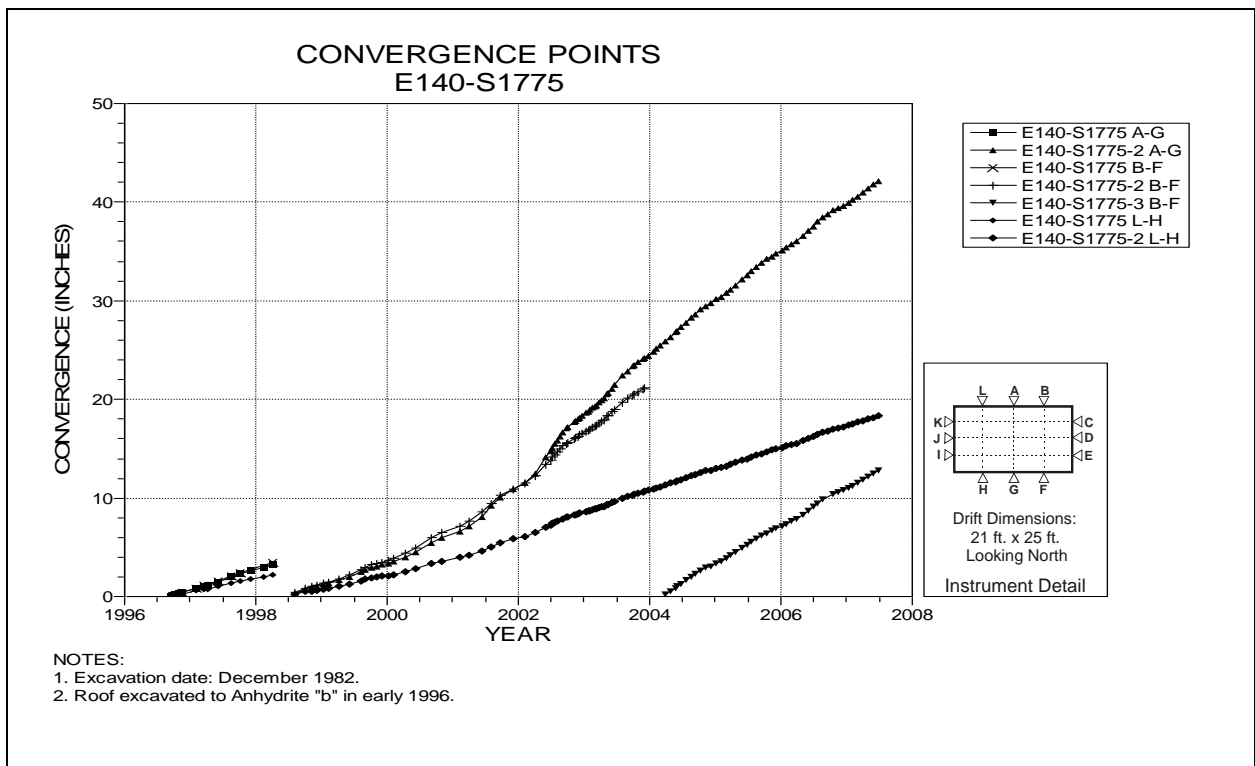


Figure 4-104 Convergence Point Array  
E140 Drift at S1775 – Roof to Floor



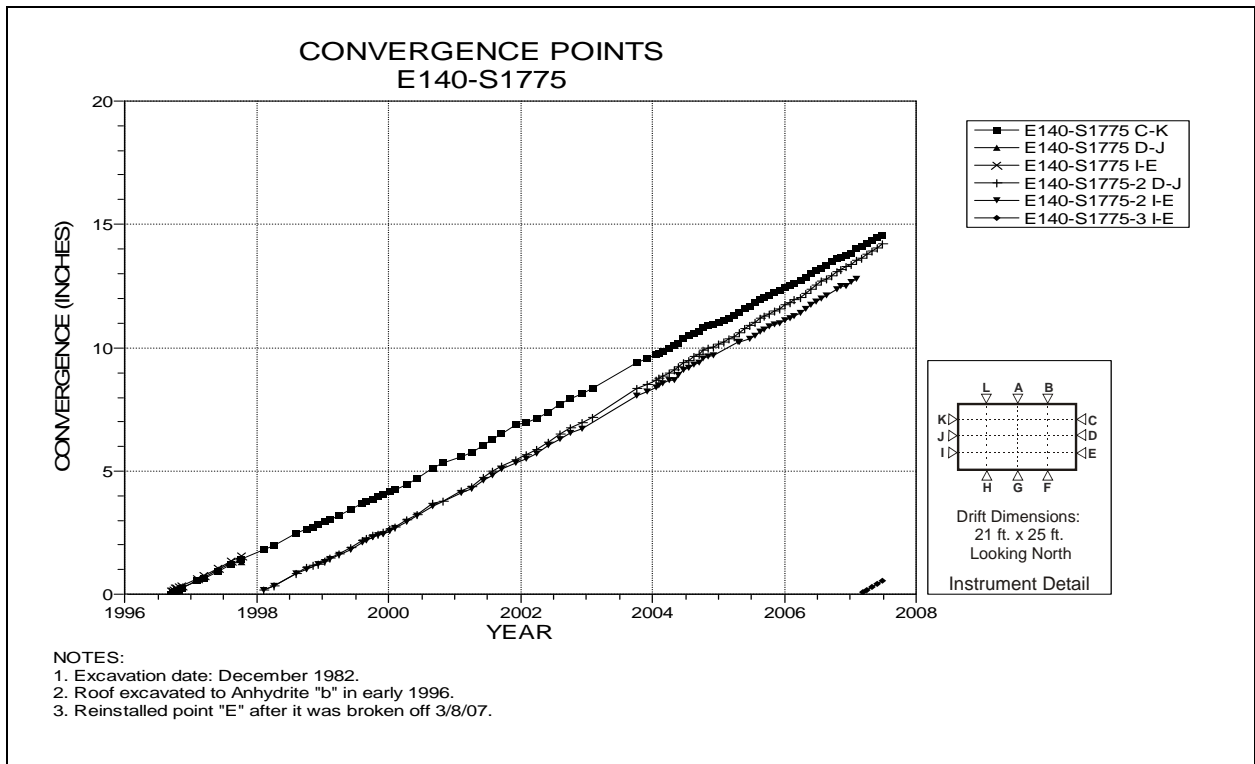


Figure 4-105 Convergence Point Array  
E140 Drift at S1775 – Rib to Rib

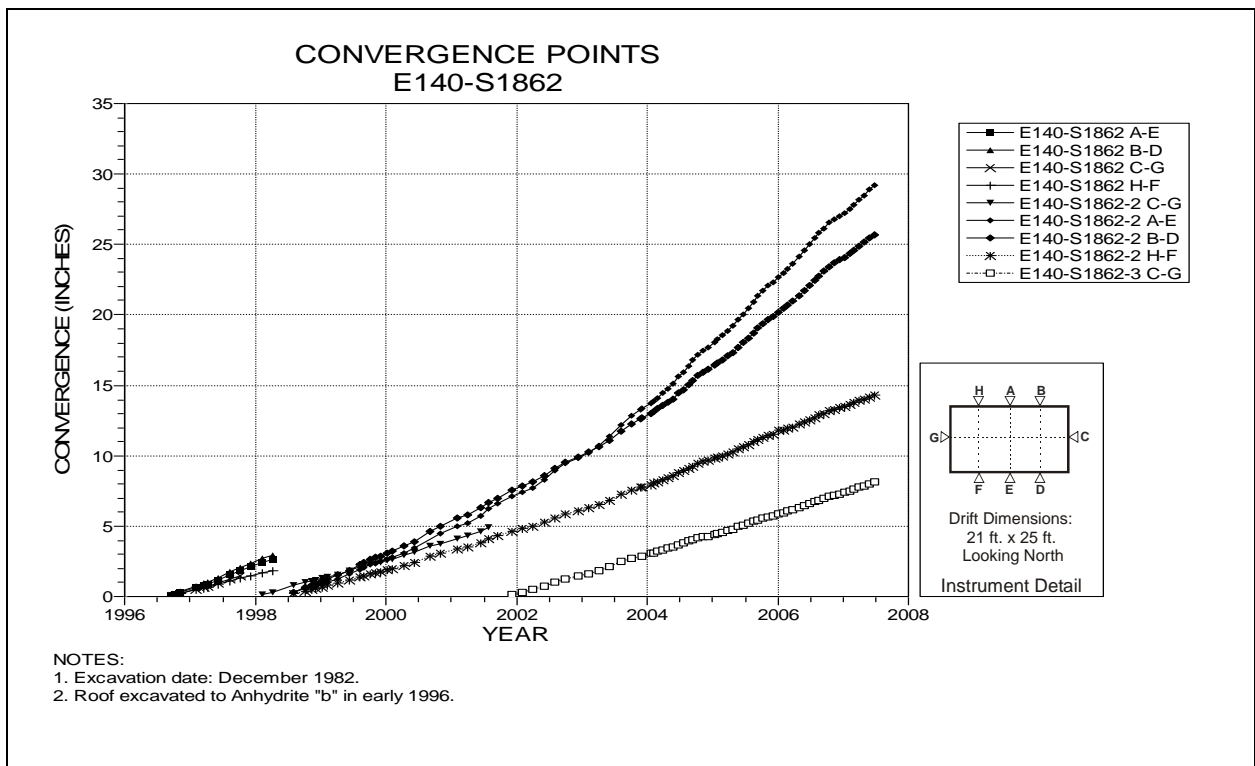


Figure 4-106 Convergence Point Array  
E140 Drift at S1862 – All Chords

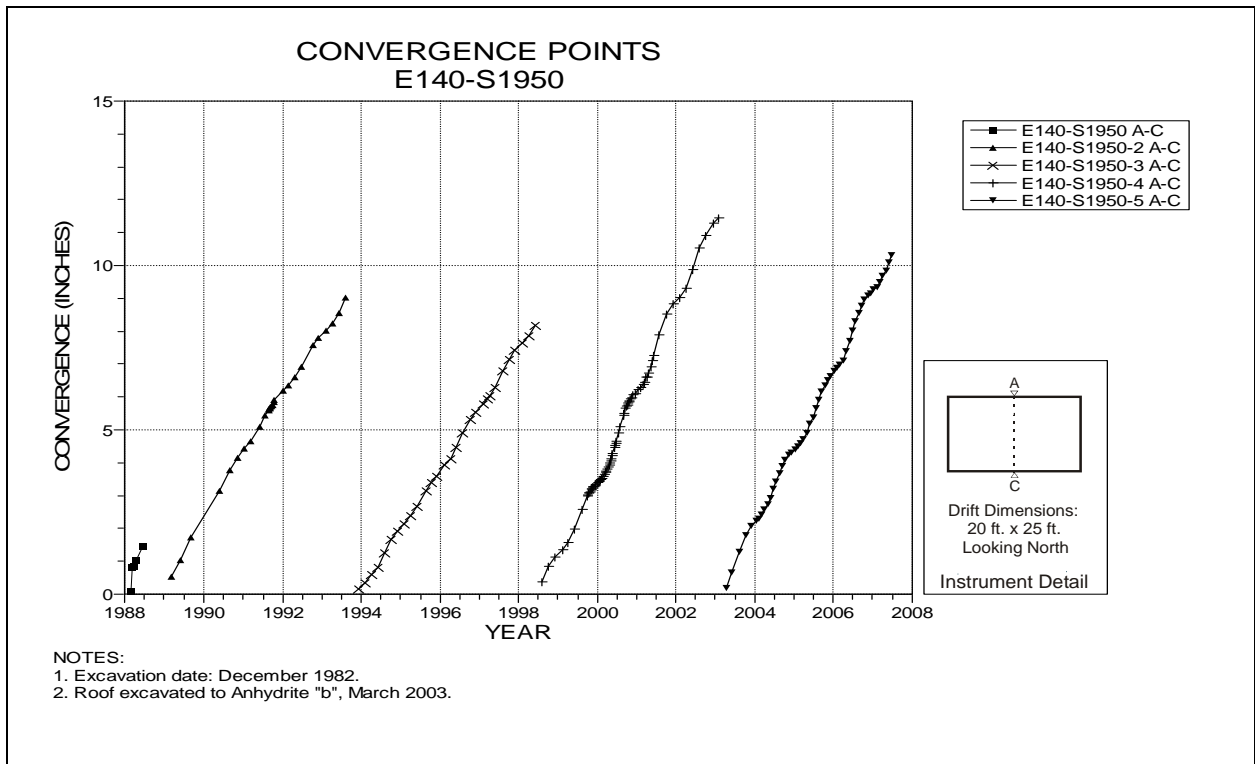


Figure 4-107 Convergence Point Array  
E140 Drift at S1950 Drift Intersection – Roof to Floor

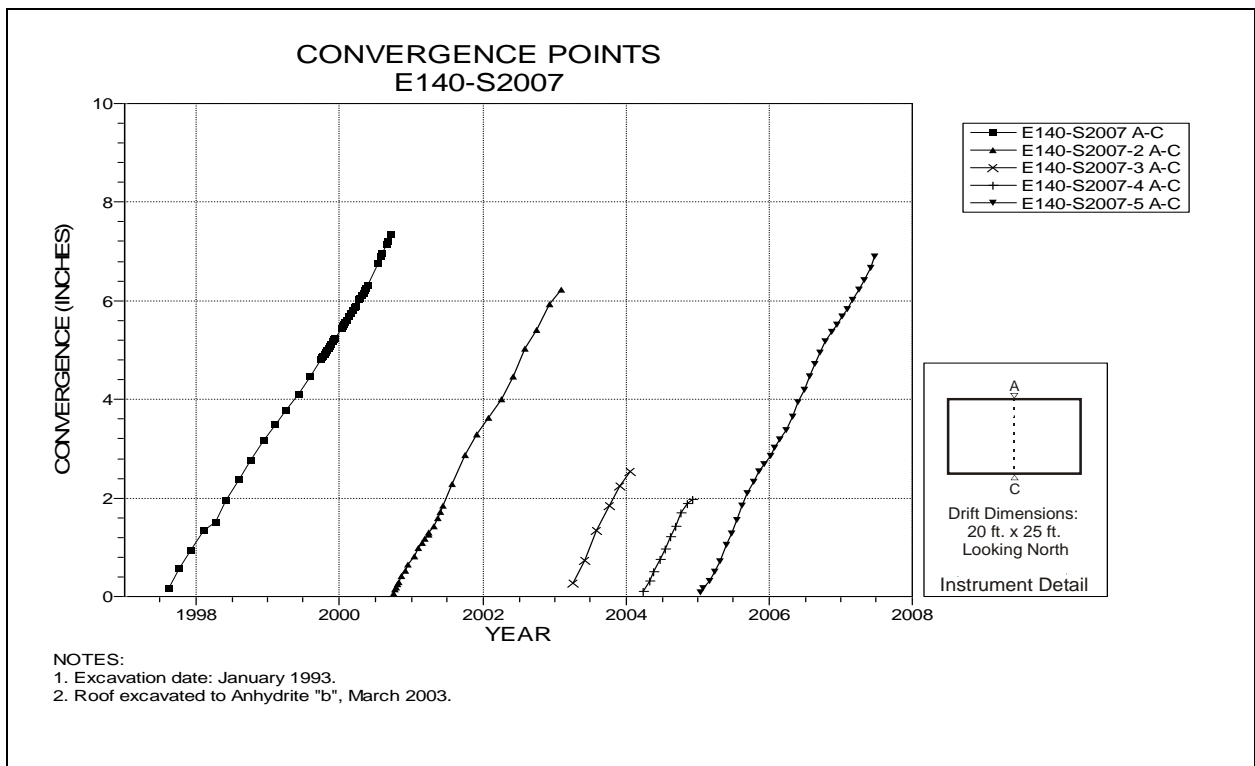


Figure 4-108 Convergence Point Array  
E140 Drift at S2007 – Roof to Floor

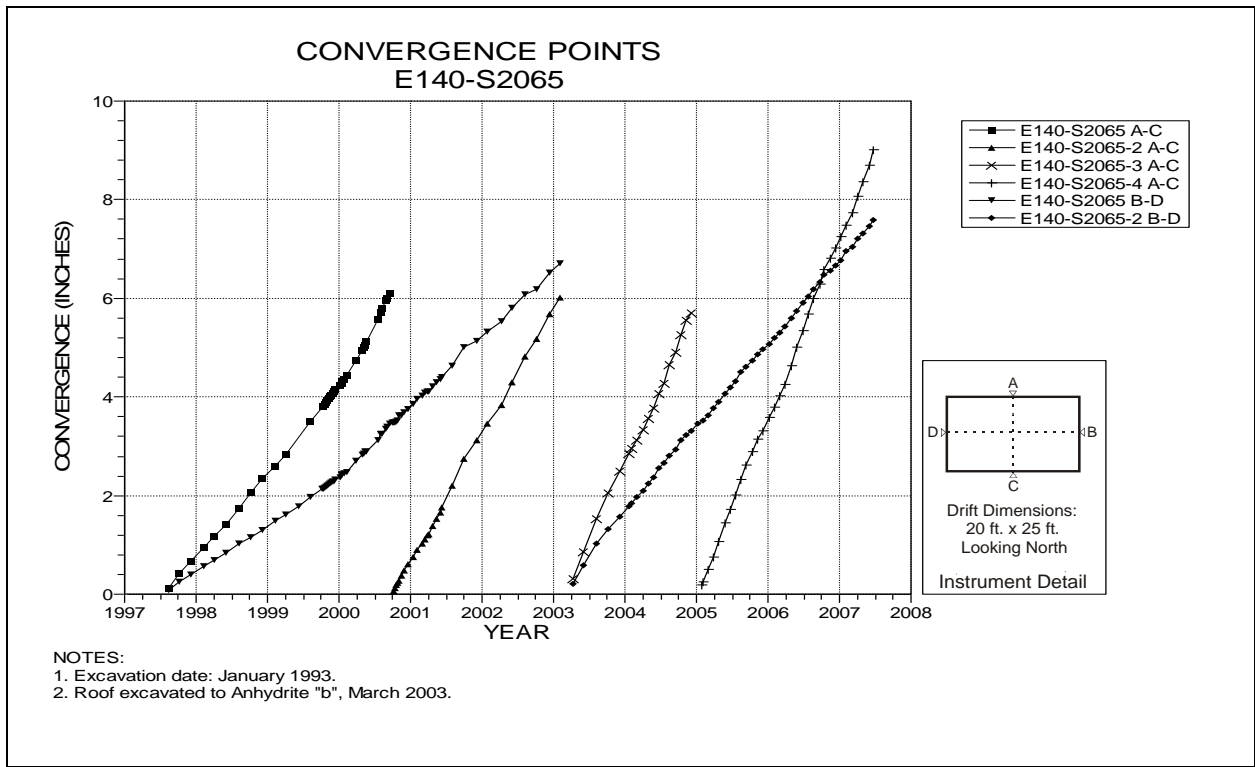


Figure 4-109 Convergence Point Array  
E140 Drift at S2065 – All Chords

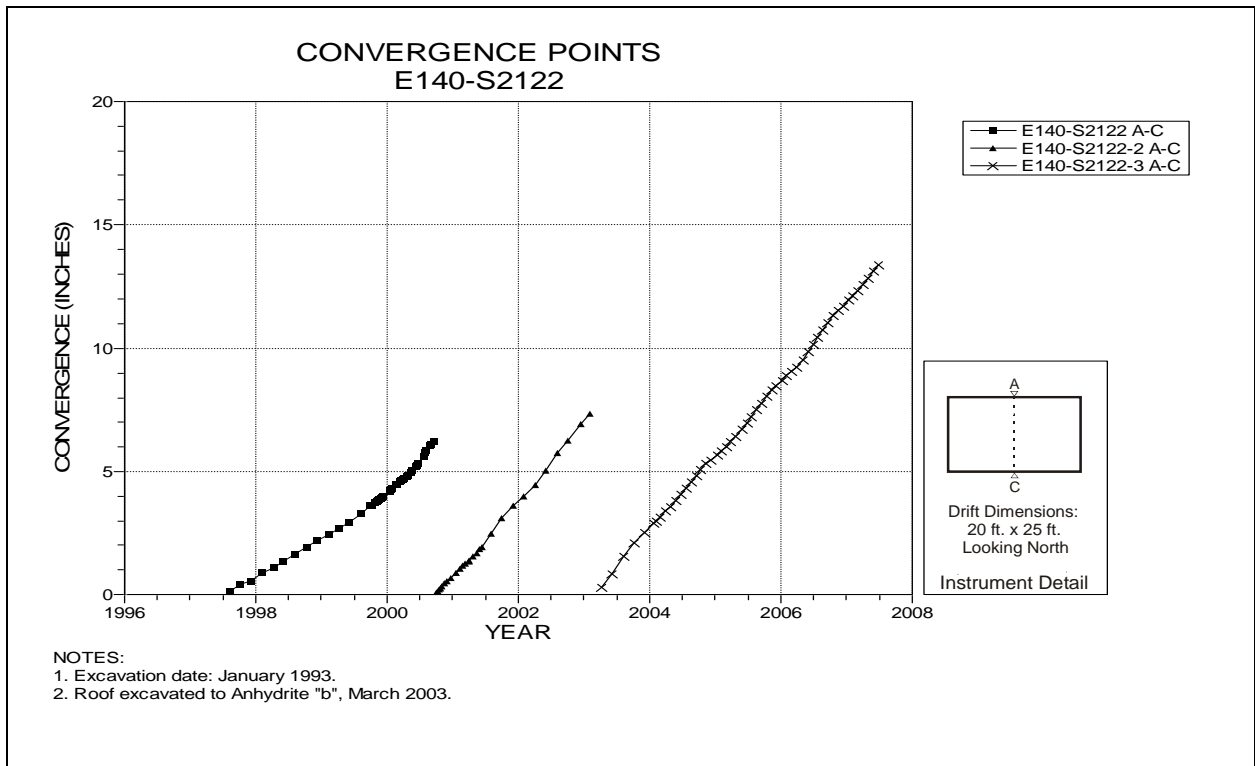


Figure 4-110 Convergence Point Array  
E140 Drift at S2122 – Roof to Floor

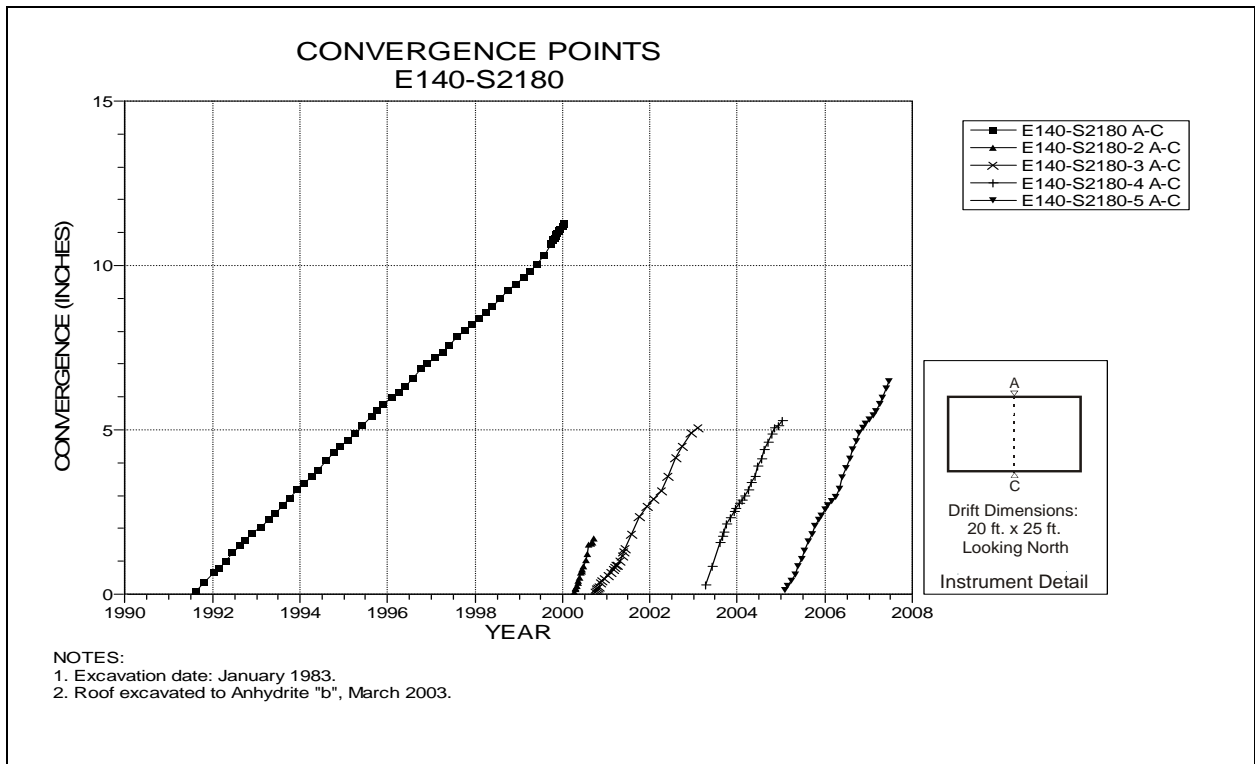


Figure 4-111 Convergence Point Array  
E140 Drift at S2180 Drift Intersection – Roof to Floor

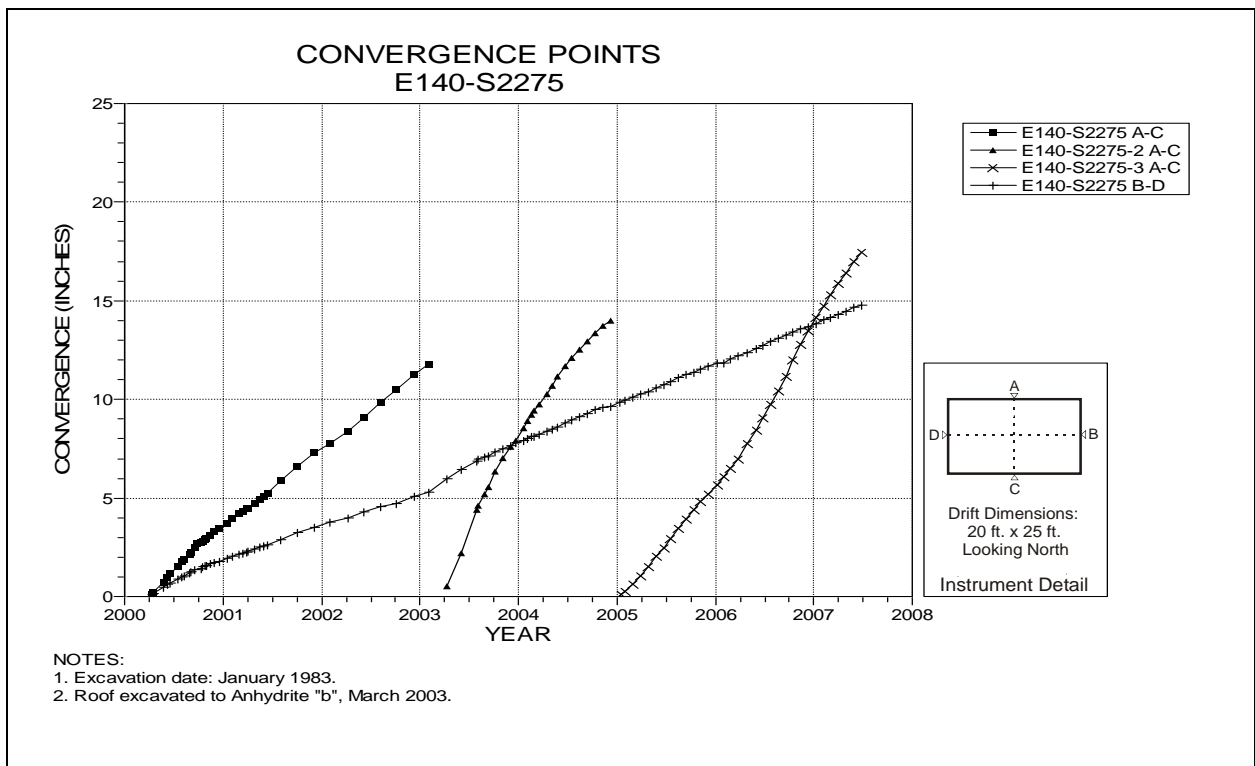


Figure 4-112 Convergence Point Array  
E140 Drift at S2275 – All Chords

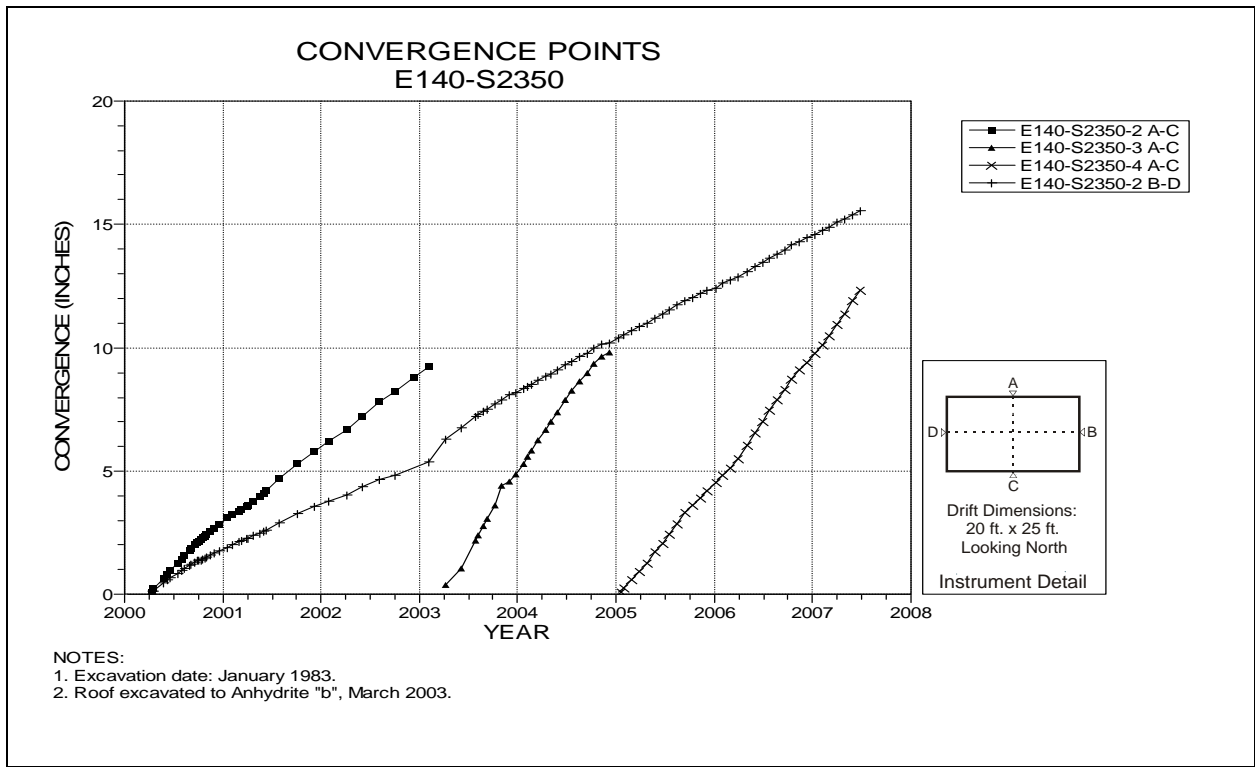


Figure 4-113 Convergence Point Array  
E140 Drift at S2350 – All Chords

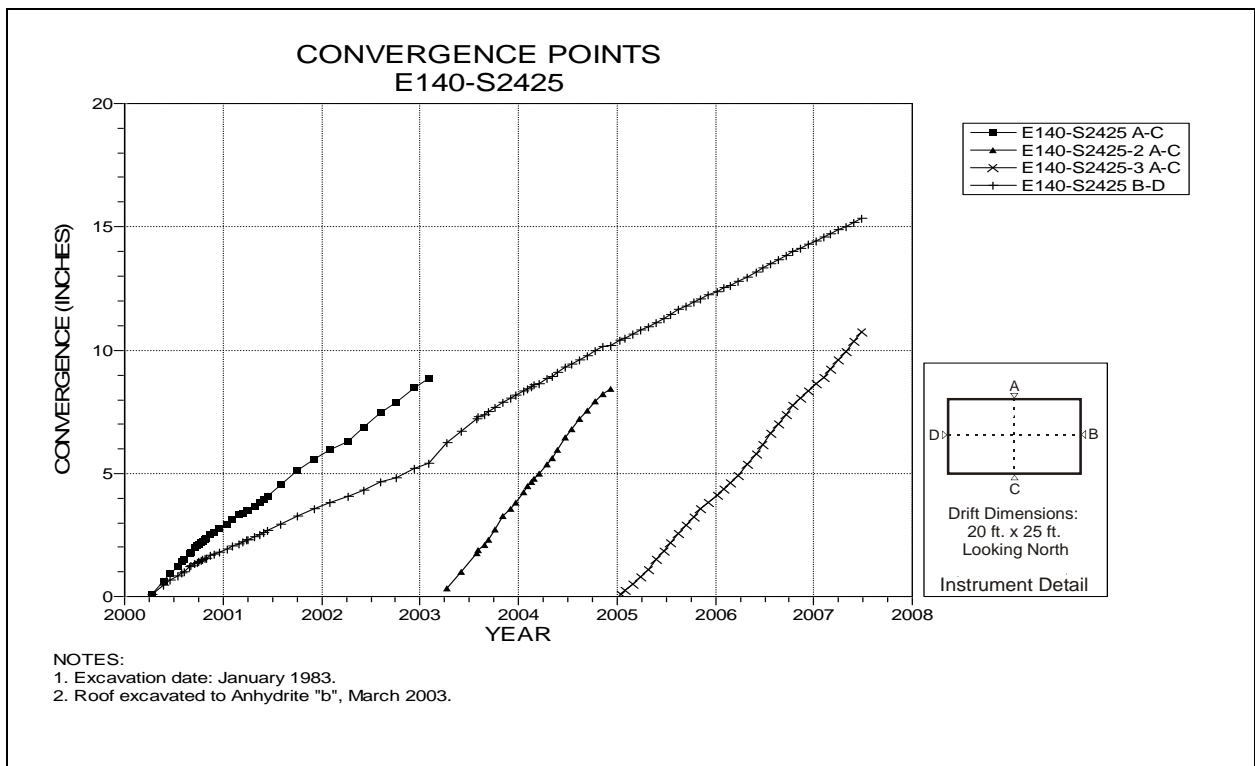


Figure 4-114 Convergence Point Array  
E140 Drift at S2425 – All Chords

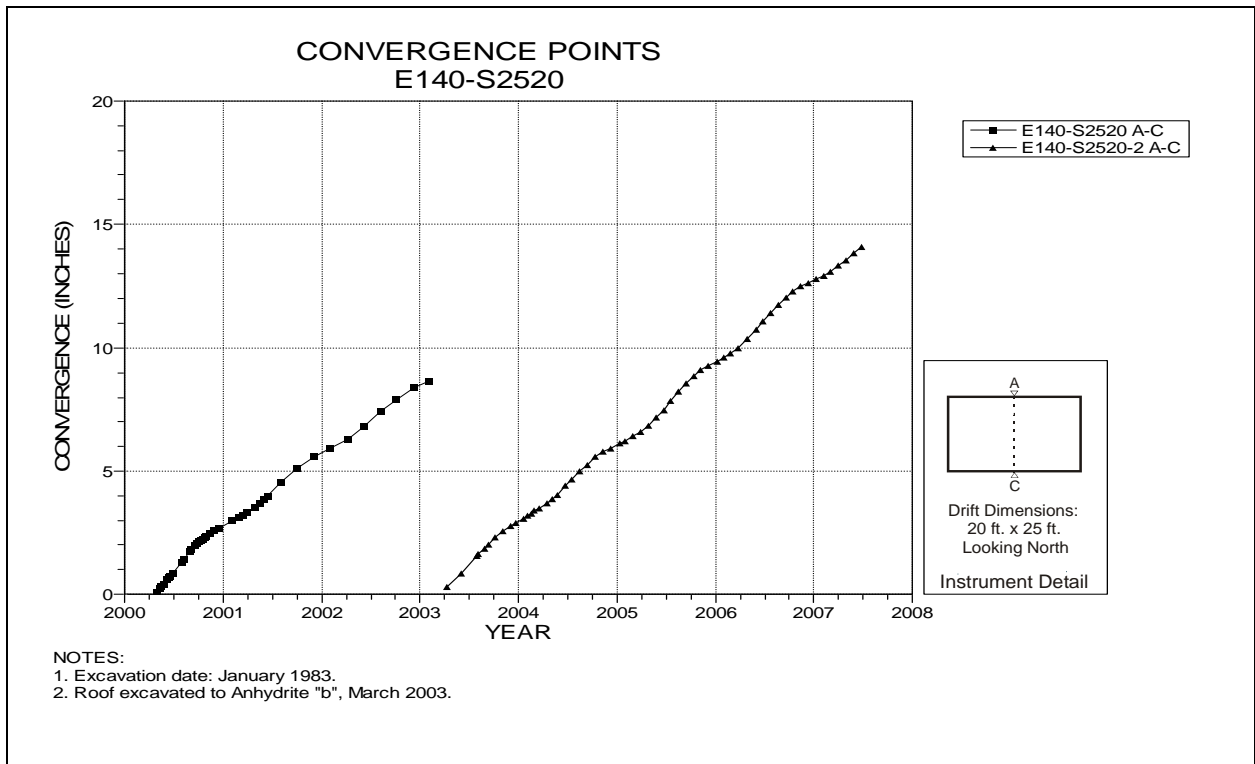


Figure 4-115 Convergence Point Array  
E140 Drift at S2520 Drift Intersection – Roof to Floor

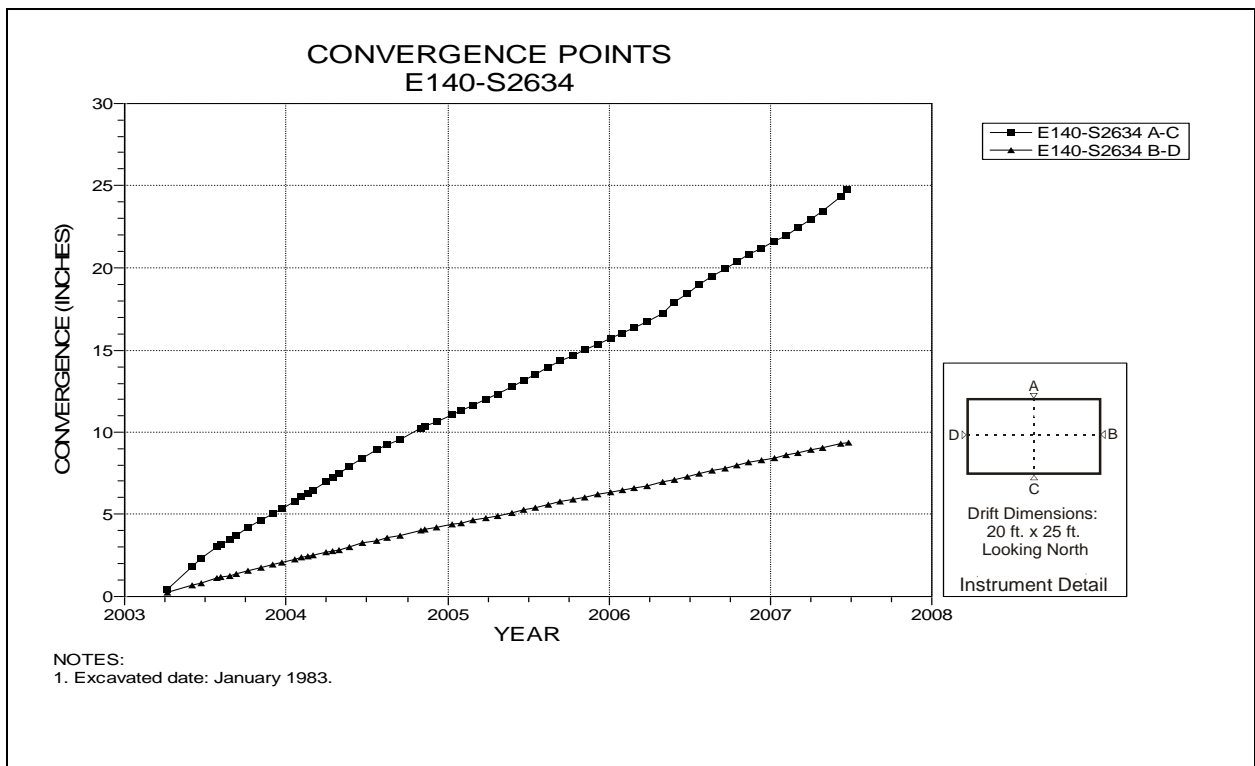


Figure 4-116 Convergence Point Array  
E140 Drift at S2634 – All Chords

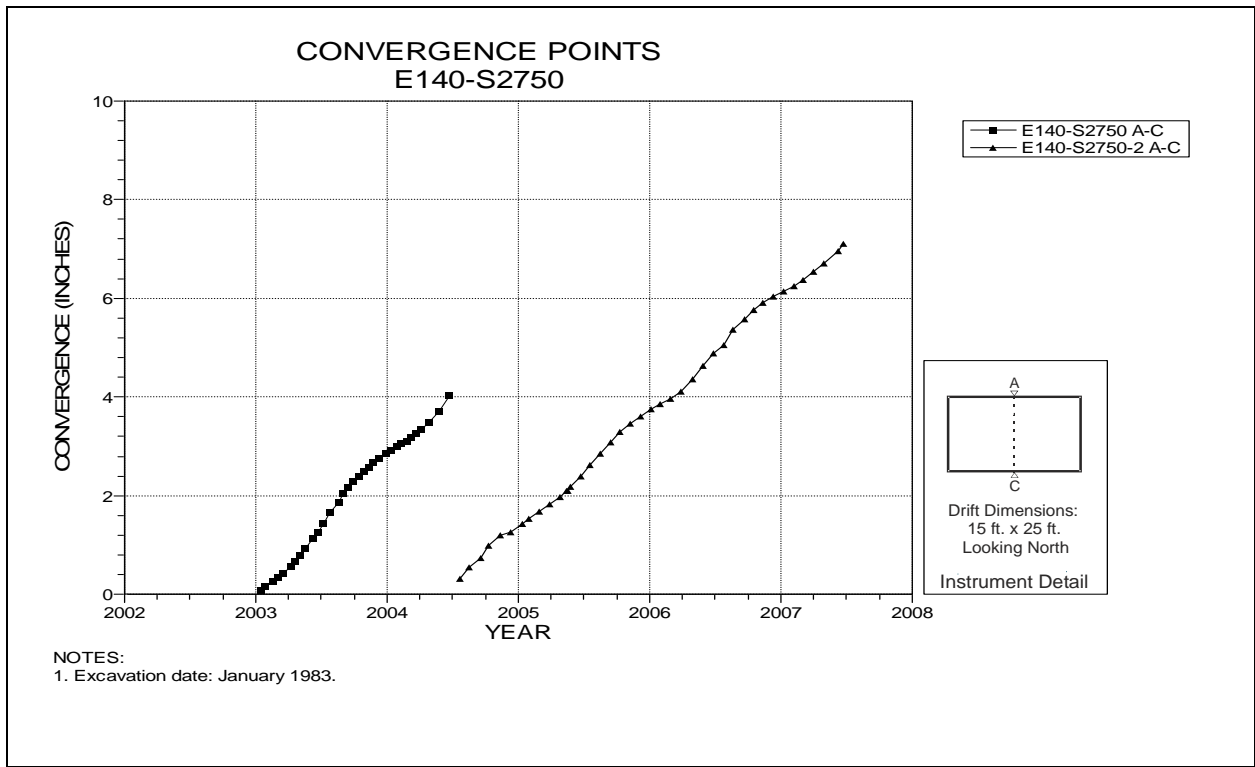


Figure 4-117 Convergence Point Array  
E140 Drift at S2750 Drift Intersection – Roof to Floor

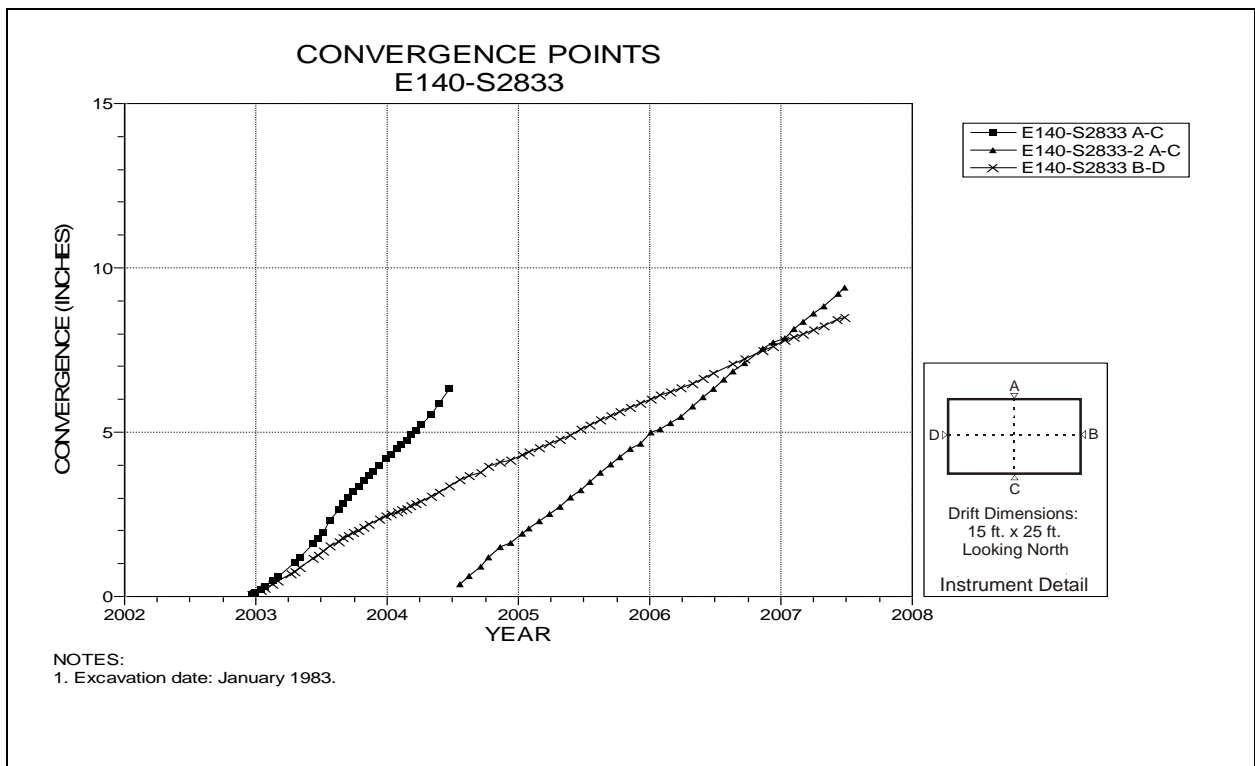


Figure 4-118 Convergence Point Array  
E140 Drift at S2833 – All Chords

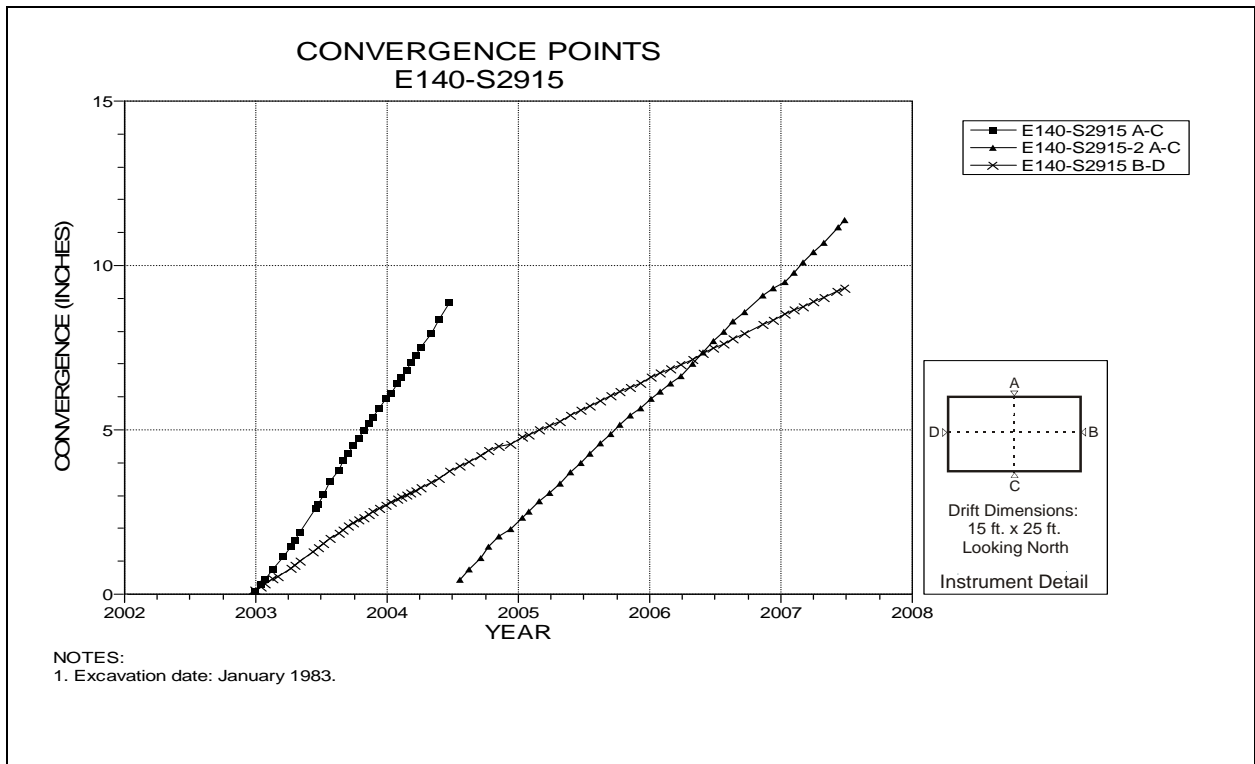


Figure 4-119 Convergence Point Array  
E140 Drift at S2915 – All Chords

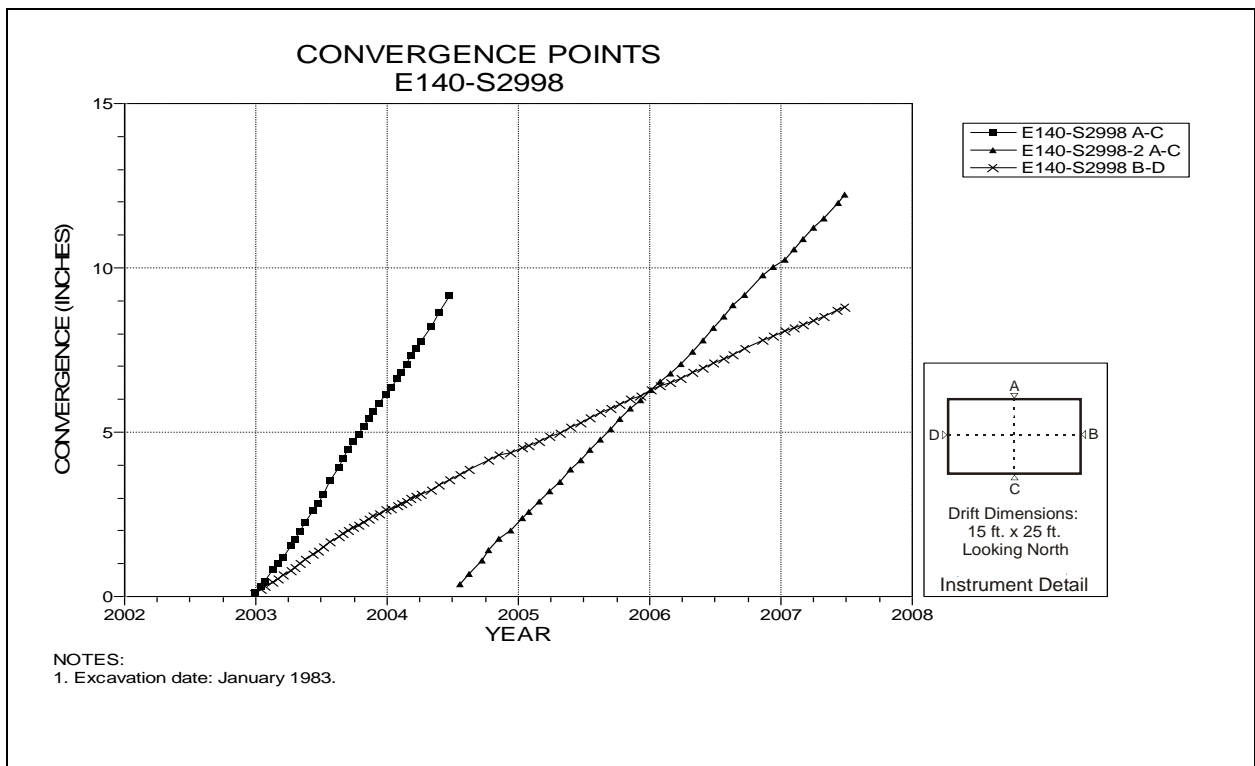


Figure 4-120 Convergence Point Array  
E140 Drift at S2998 – All Chords



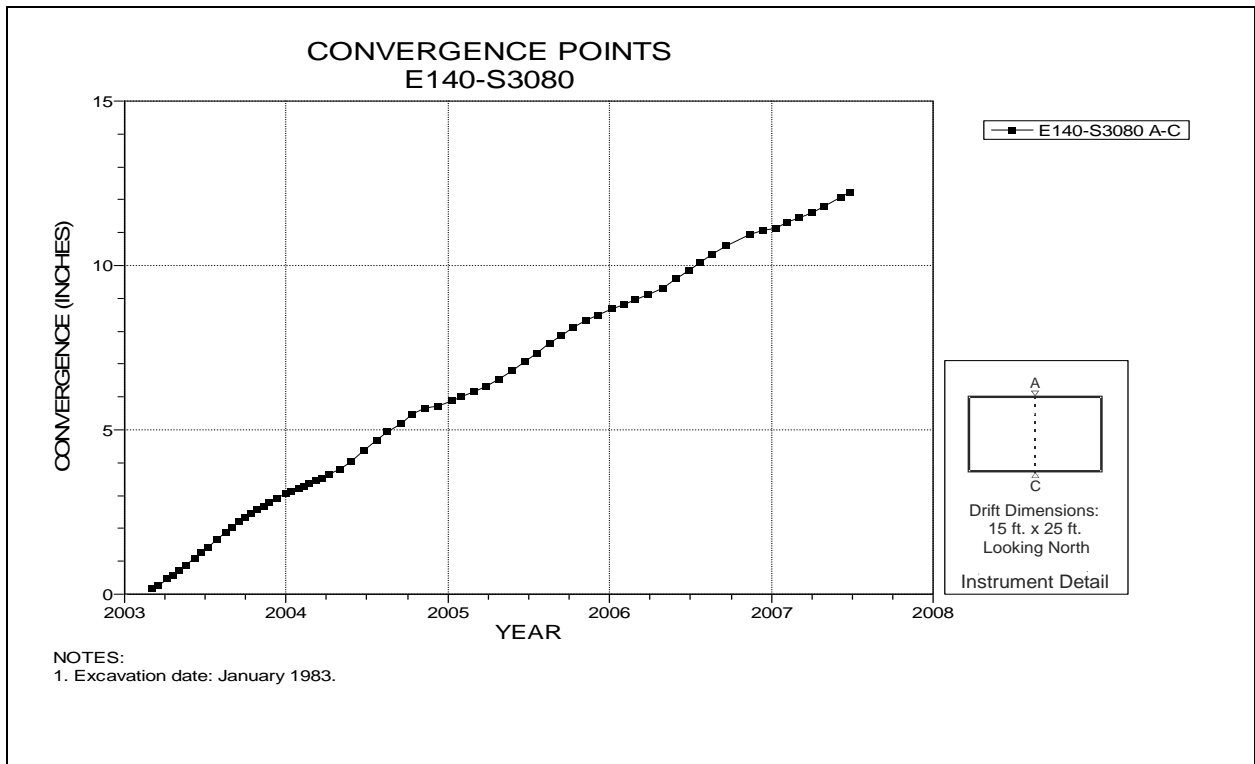


Figure 4-121 Convergence Point Array  
E140 Drift at S3080 Drift Intersection – Roof to Floor

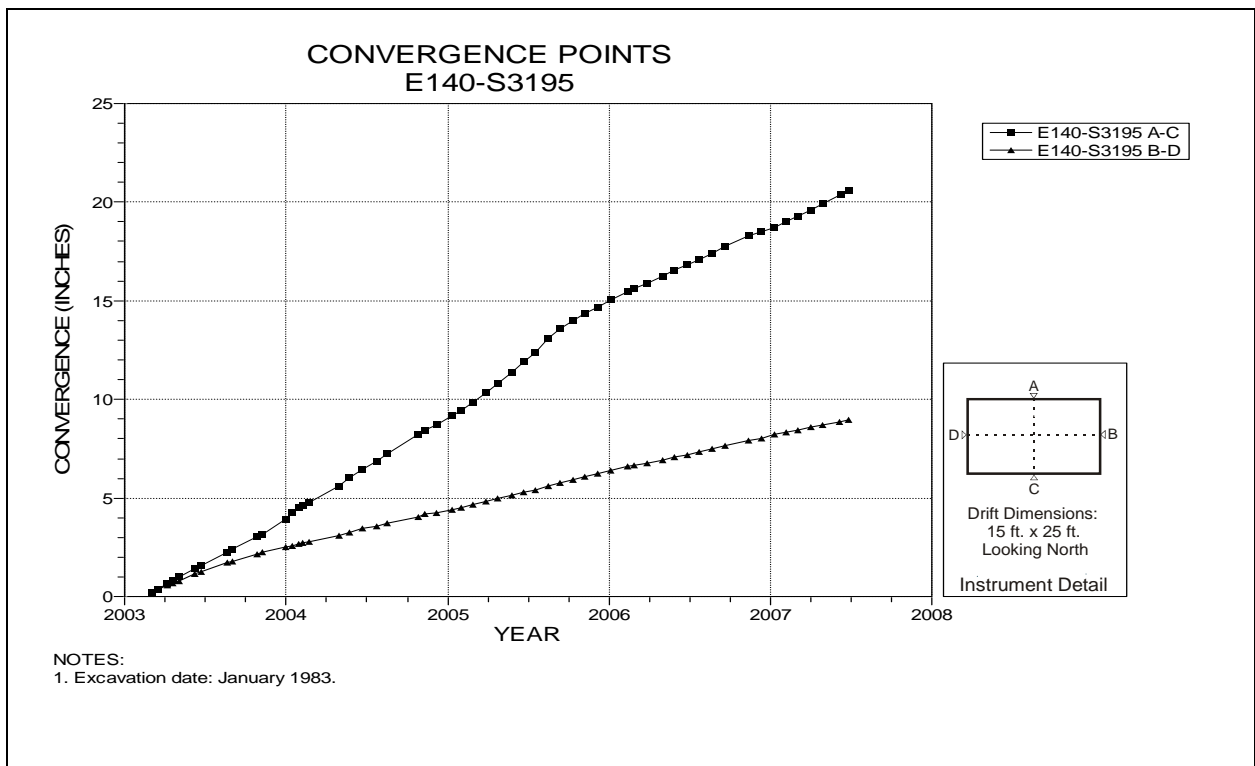


Figure 4-122 Convergence Point Array  
E140 Drift at S3195 – All Chords

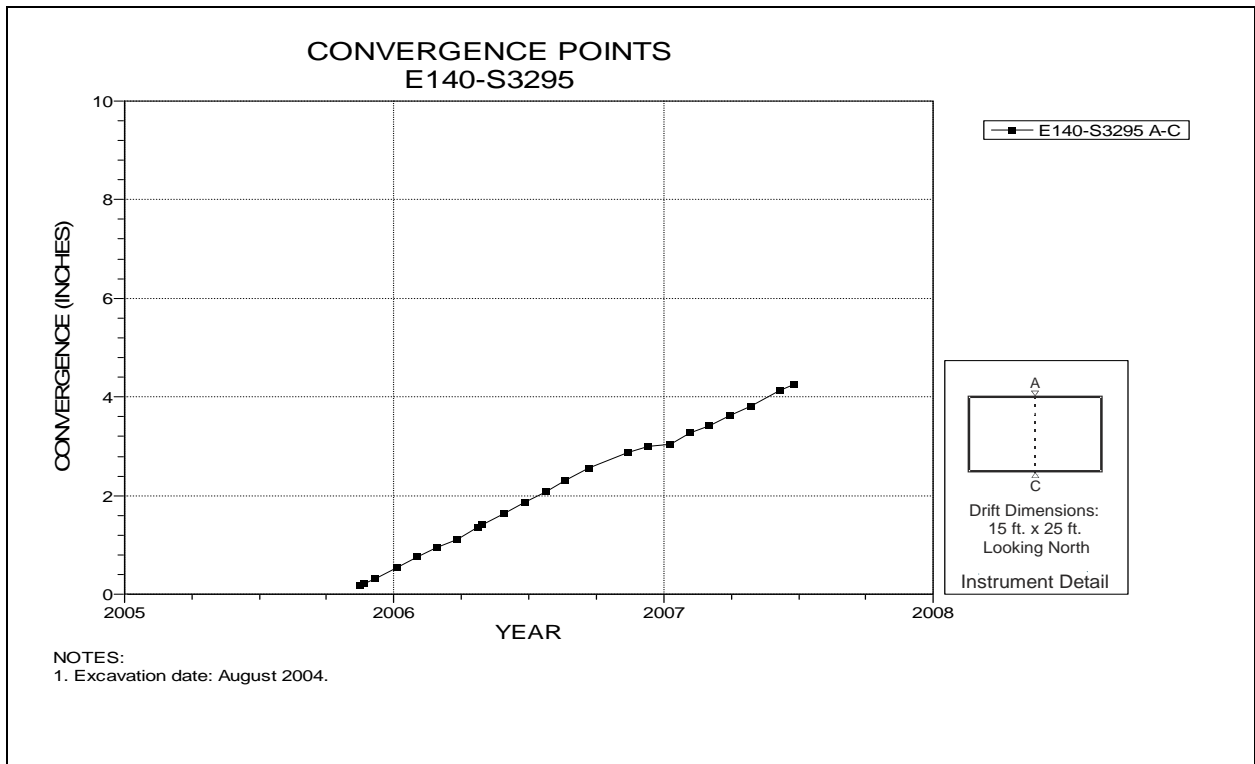


Figure 4-123 Convergence Point Array  
E140 Drift at S3295 – Roof to Floor

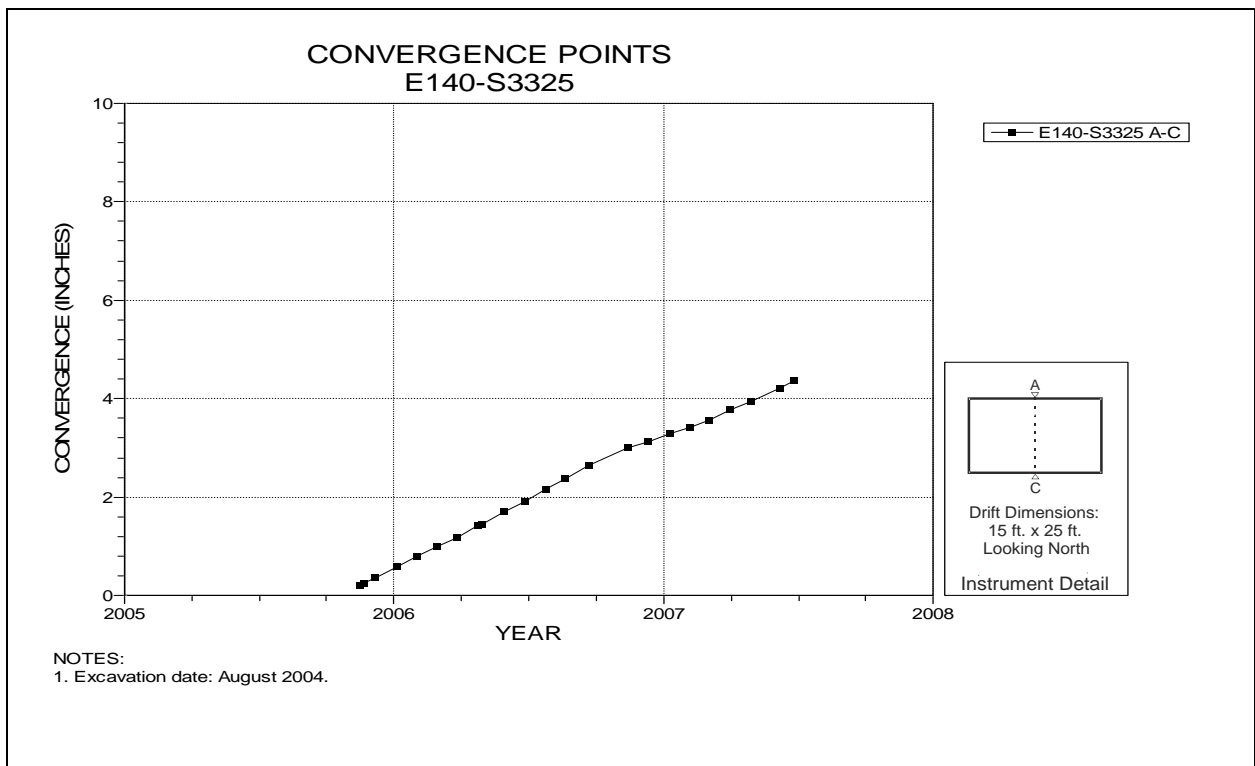


Figure 4-124 Convergence Point Array  
E140 Drift at S3325 – Roof to Floor

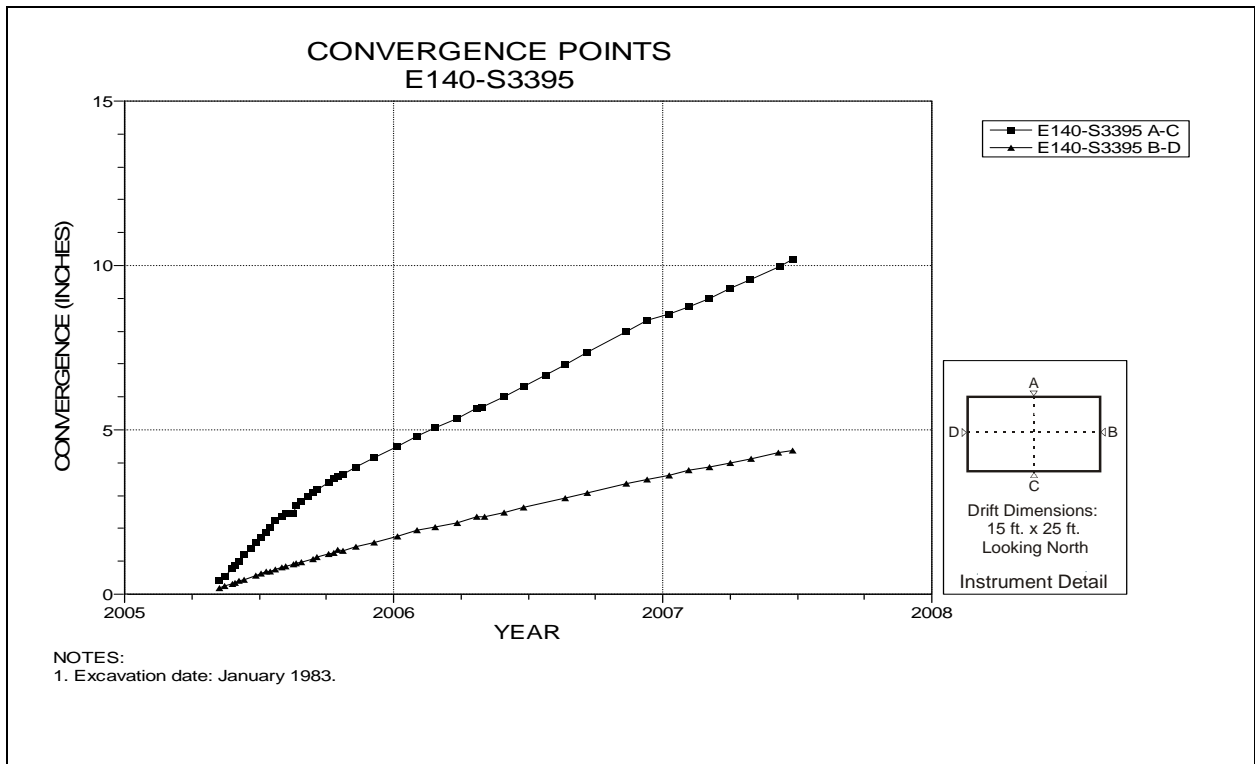


Figure 4-125 Convergence Point Array  
E140 Drift at S3395 – All Chords

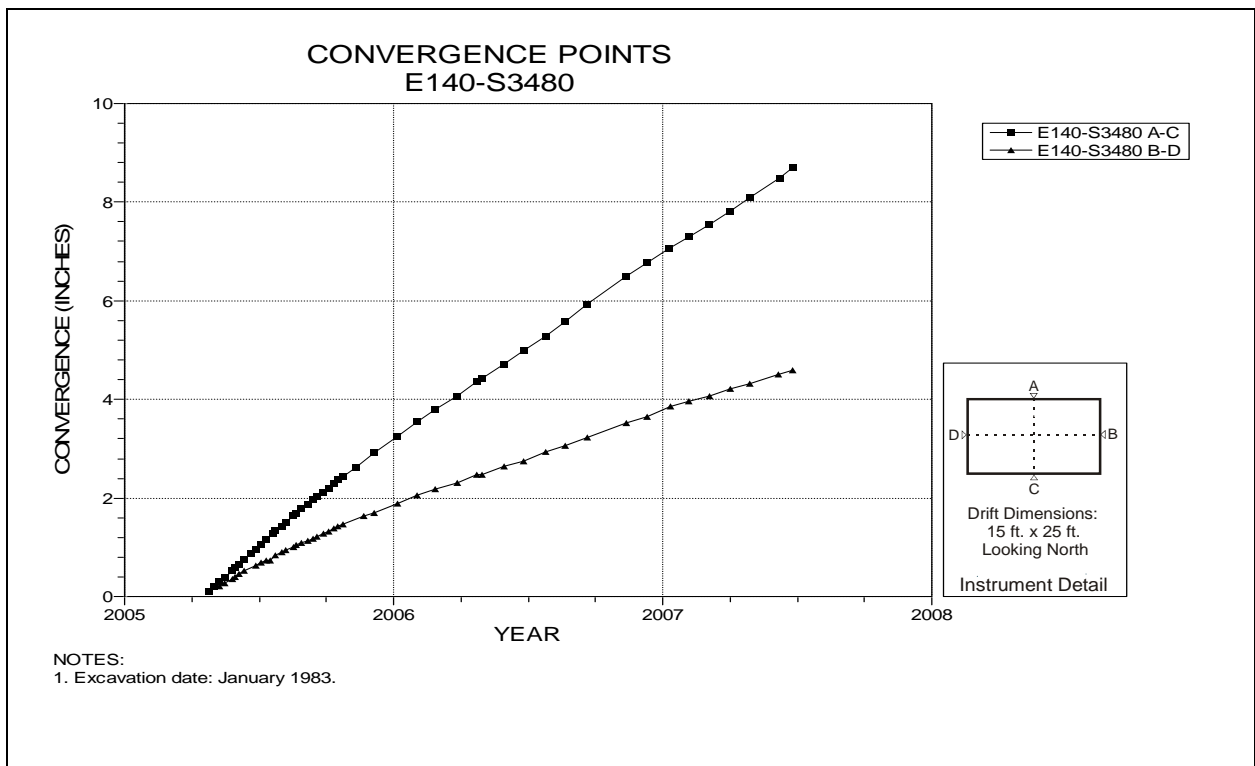


Figure 4-126 Convergence Point Array  
E140 Drift at S3480 – All Chords

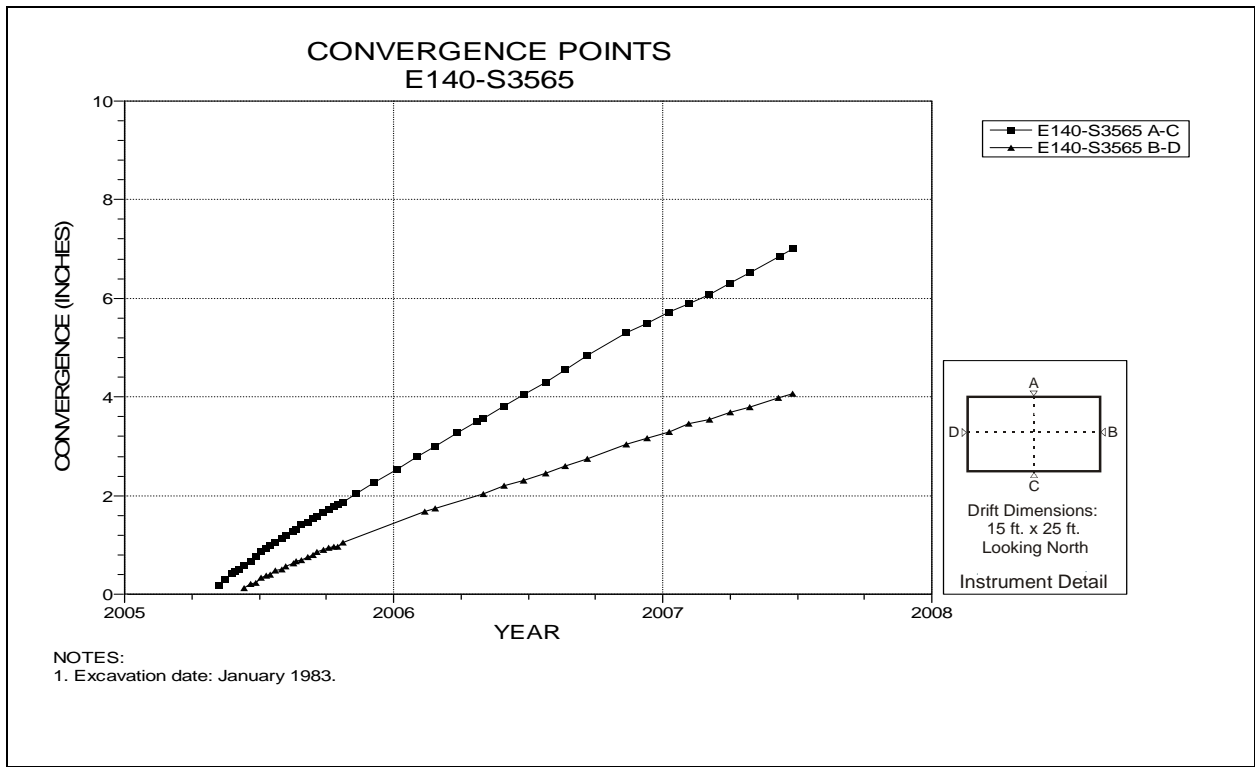


Figure 4-127 Convergence Point Array  
E140 Drift at S3565 – All Chords

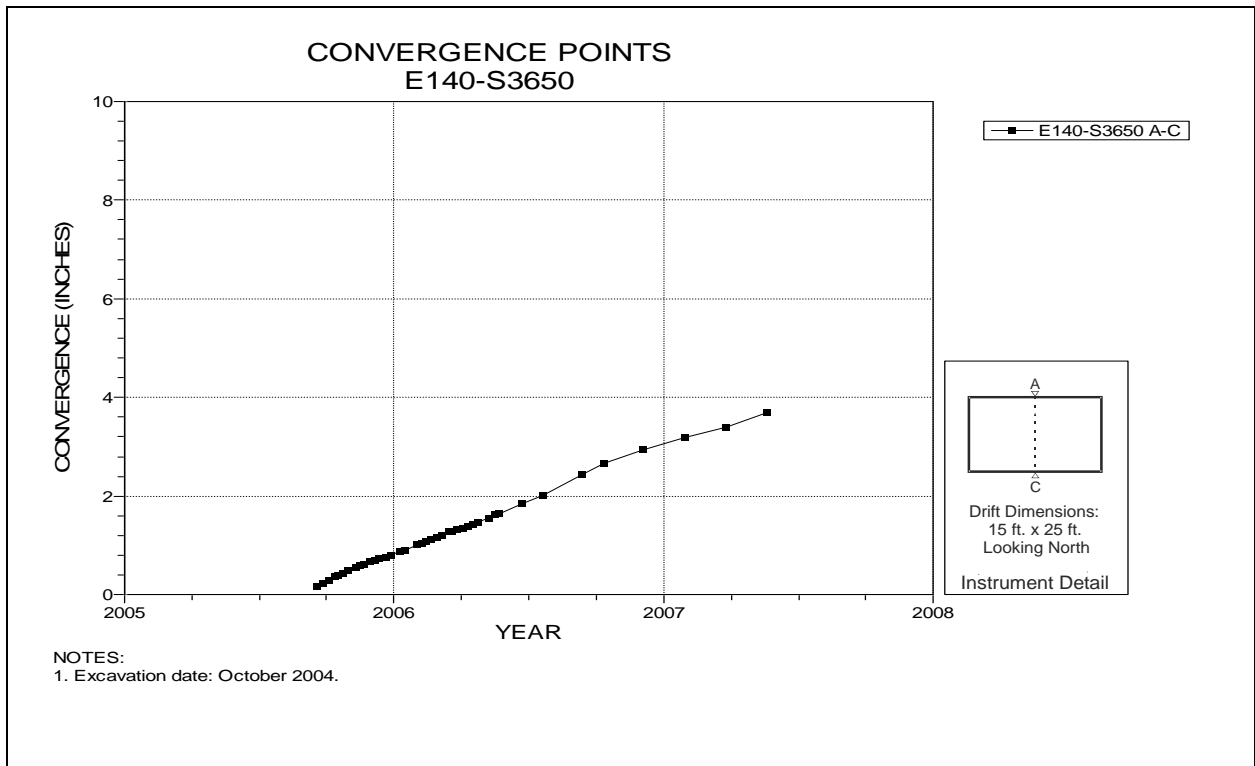


Figure 4-128 Convergence Point Array  
E140 Drift at S3650 Drift Intersection – All Chords

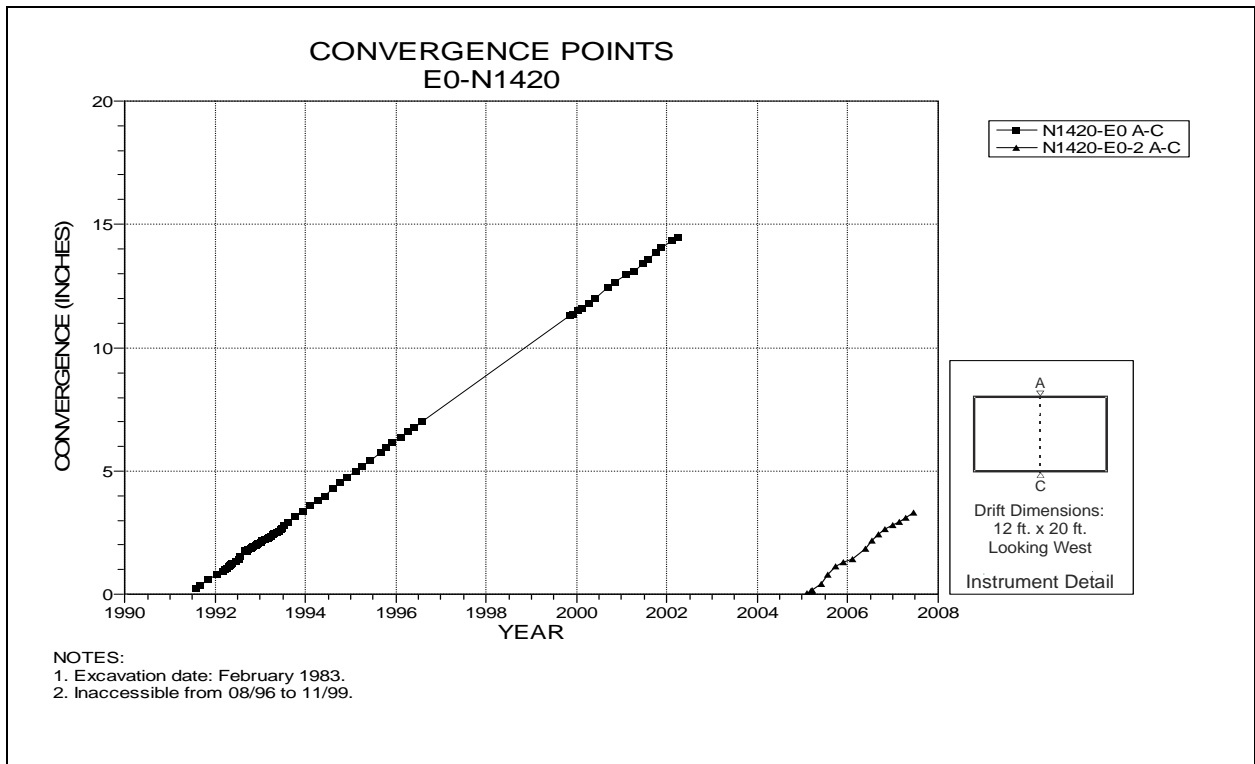


Figure 4-129 Convergence Point Array  
E0 Drift at N1420 Drift Intersection – All Chords

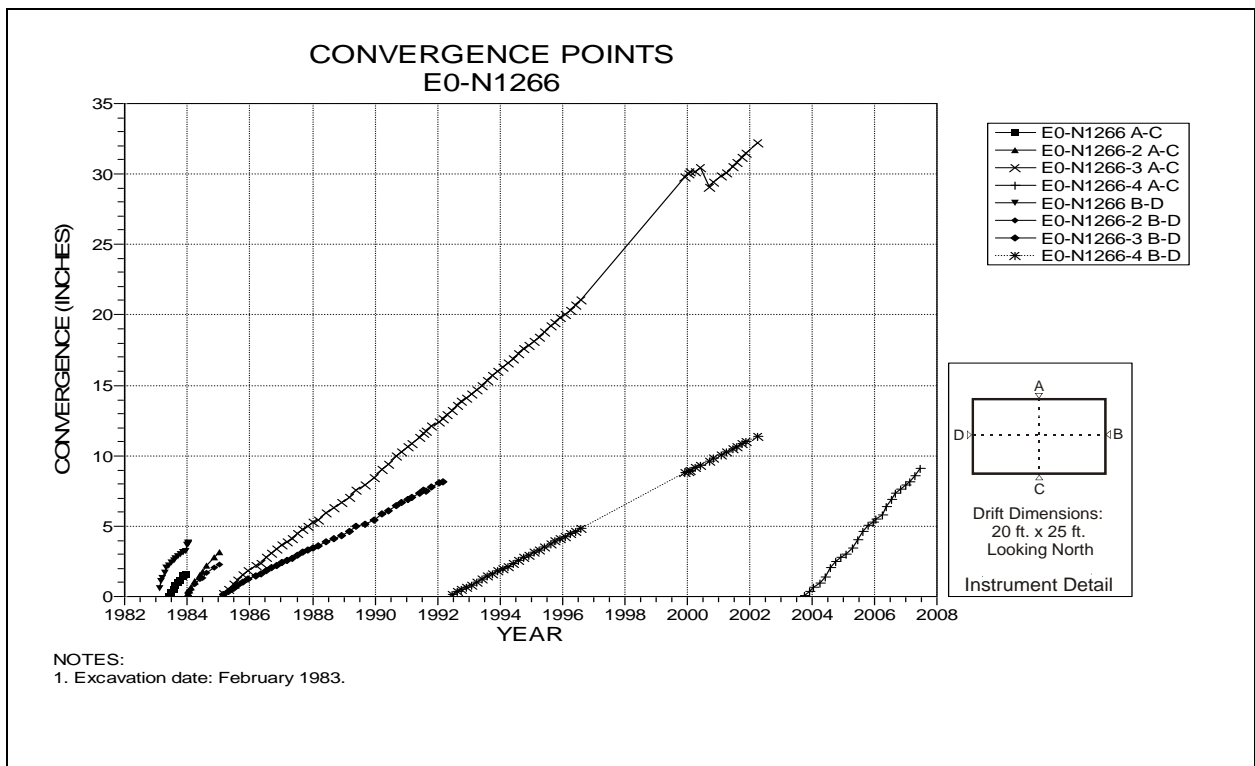


Figure 4-130 Convergence Point Array  
E0 Drift at N1266 – All Chords

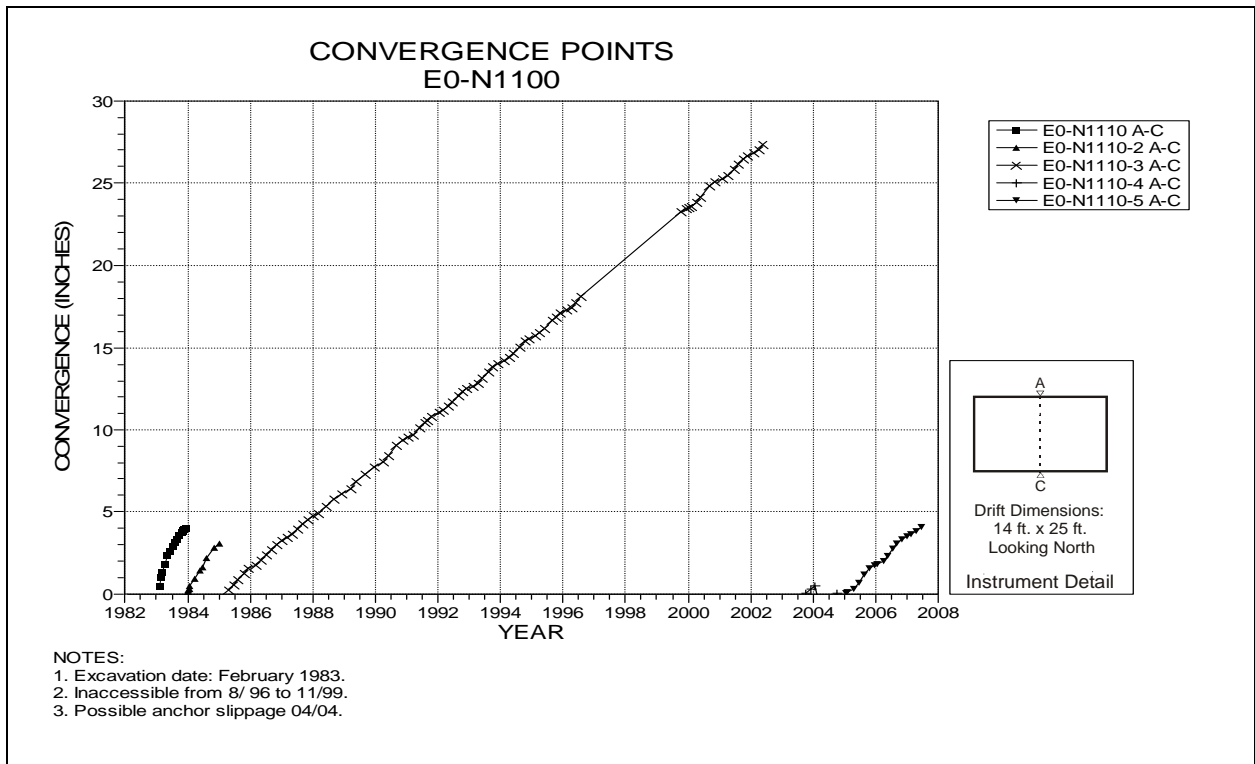


Figure 4-131 Convergence Point Array  
E0 Drift at N1100 Drift Intersection – All Chords

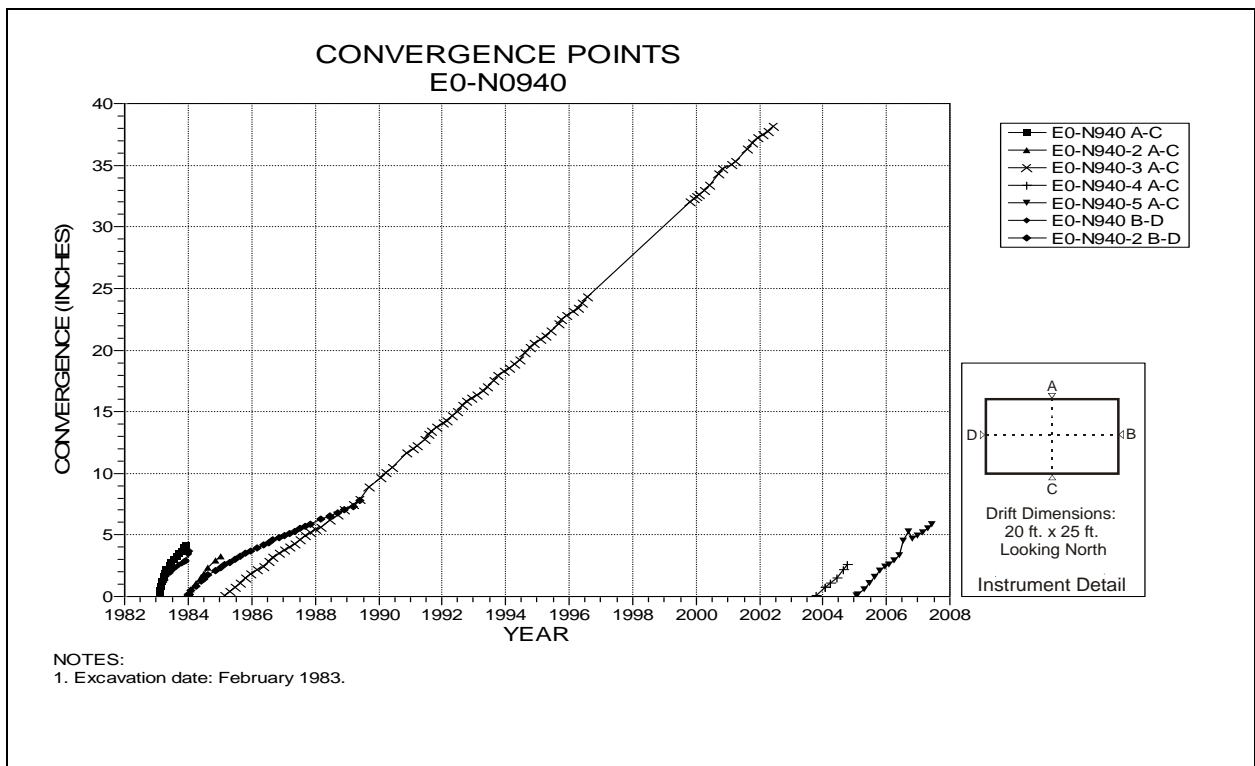


Figure 4-132 Convergence Point Array  
E0 Drift at N940 – All Chords

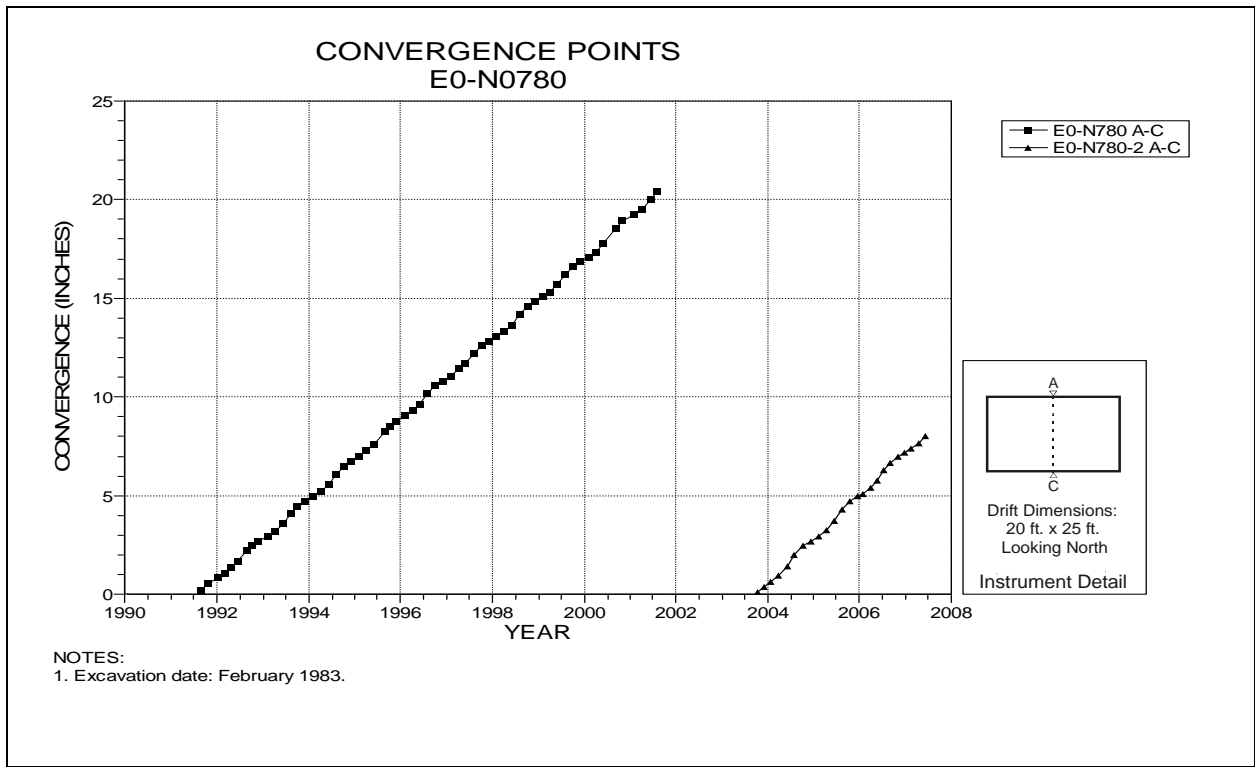


Figure 4-133 Convergence Point Array  
E0 Drift at N780 – Roof to Floor

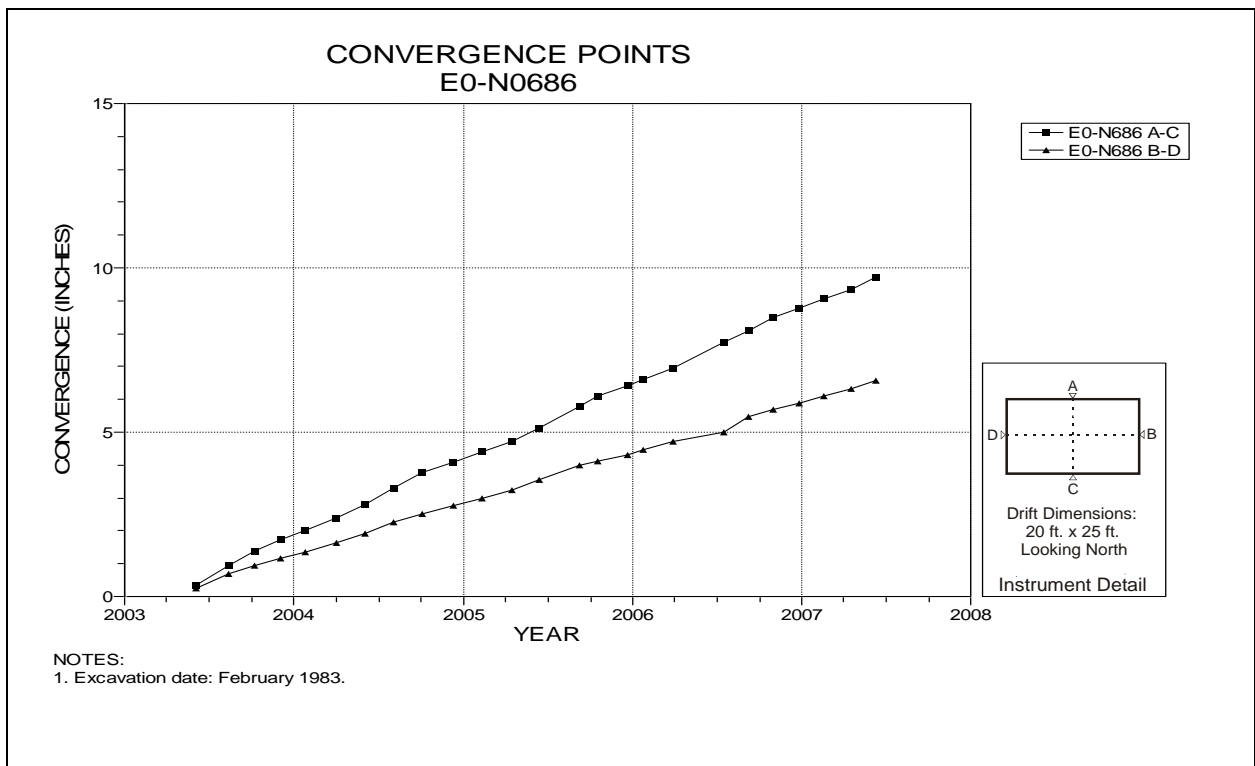


Figure 4-134 Convergence Point Array  
E0 Drift at N686 – All Chords

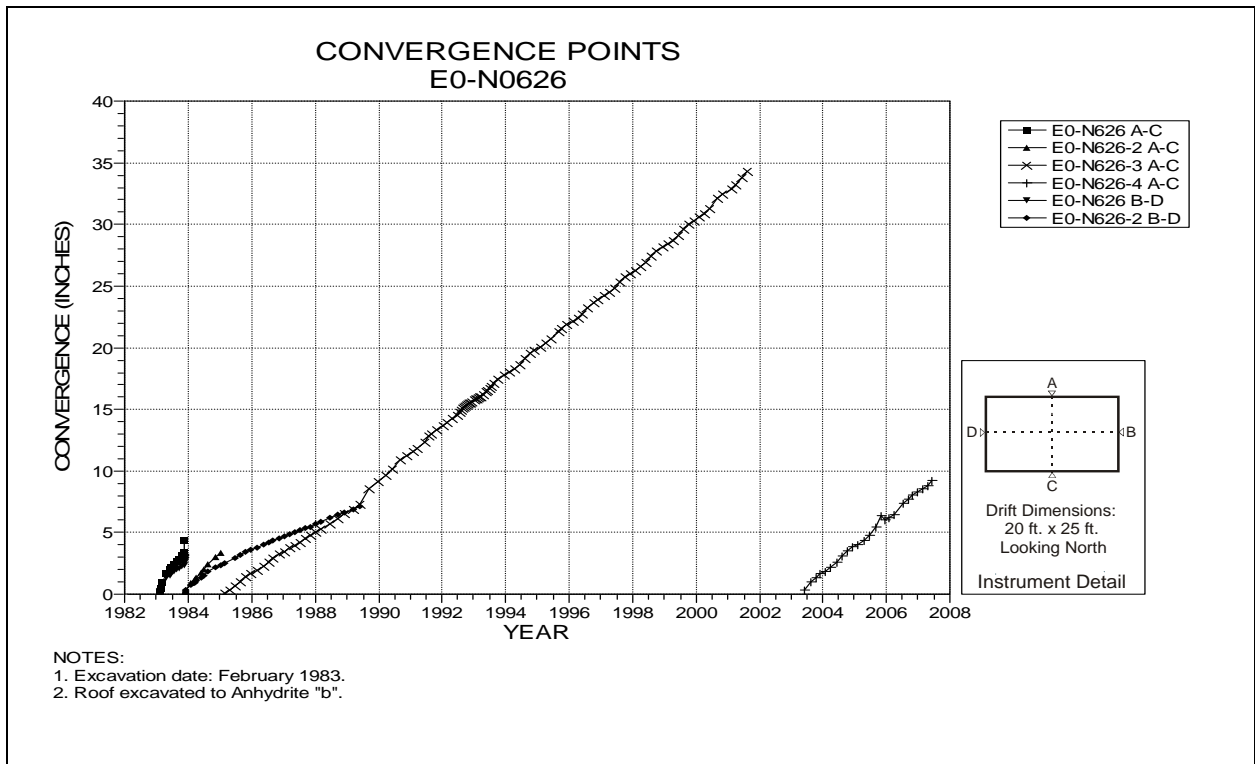


Figure 4-135 Convergence Point Array  
E0 Drift at N626 – All Chords

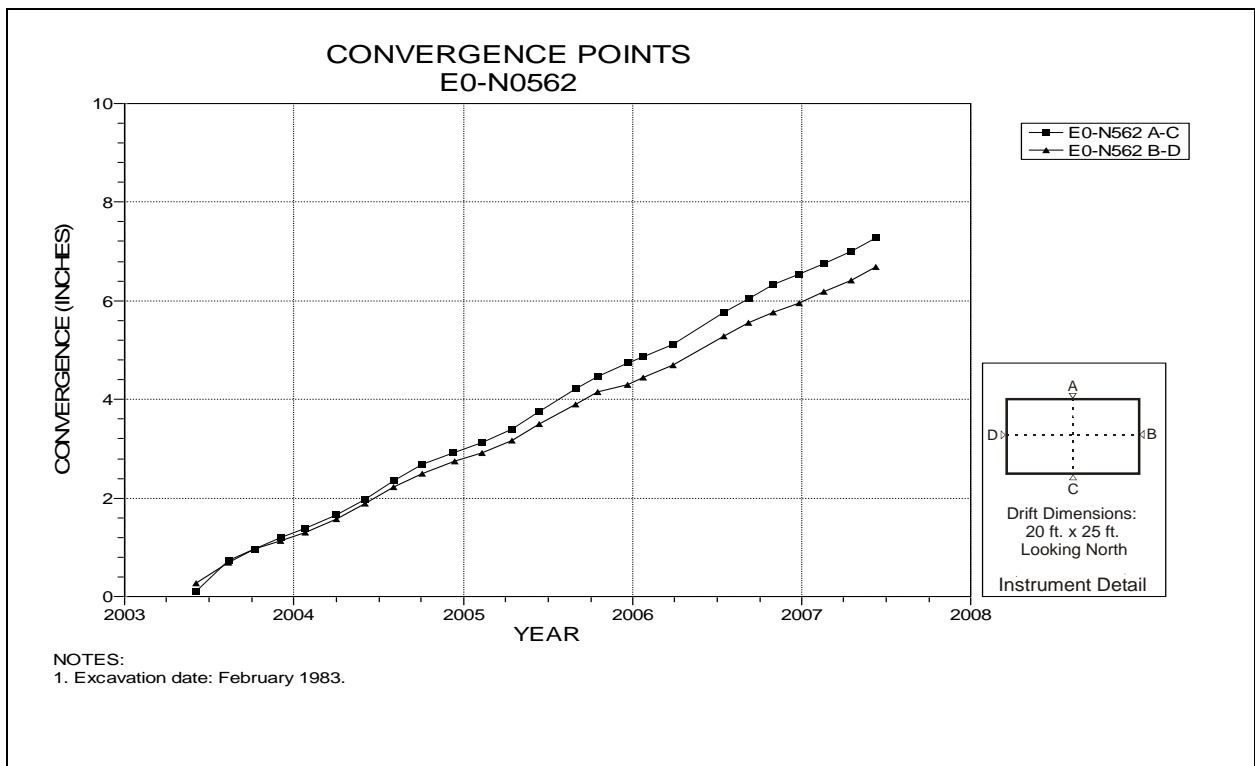


Figure 4-136 Convergence Point Array  
E0 Drift at N562 – All Chords



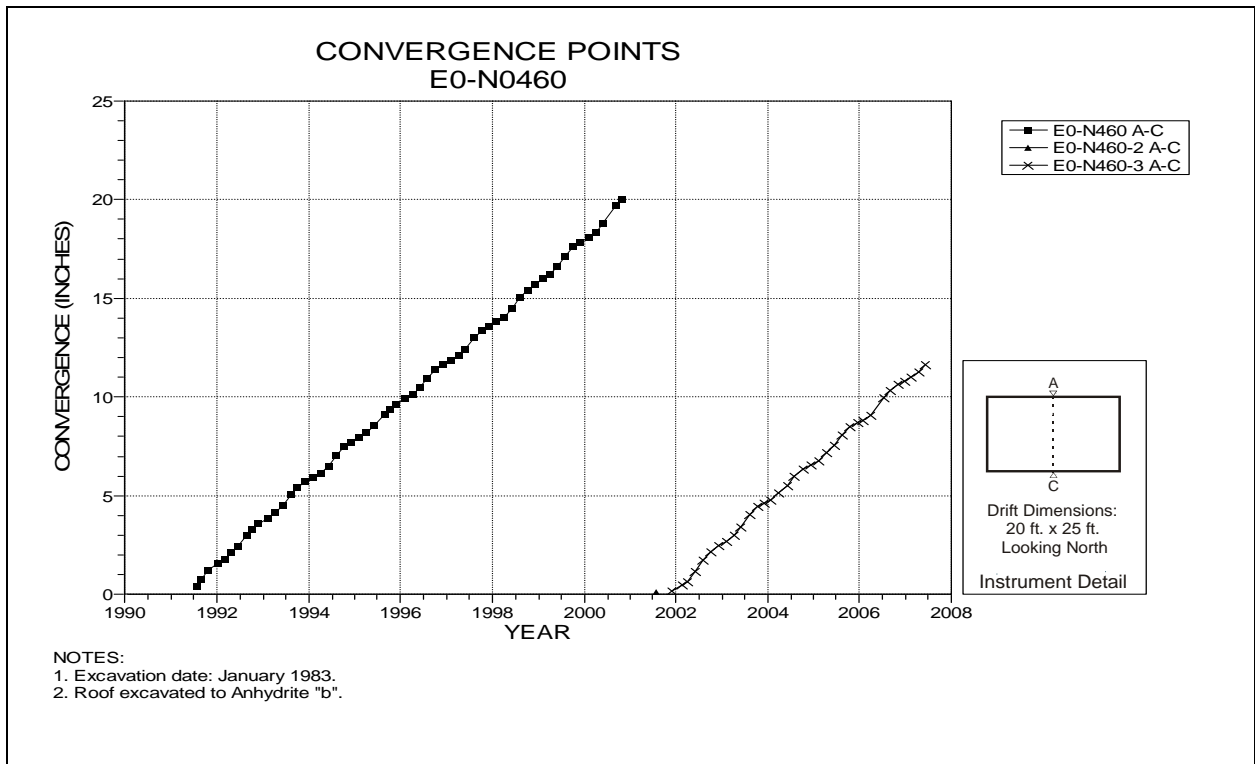


Figure 4-137 Convergence Point Array  
E0 Drift at N460 Drift Intersection – Roof to Floor

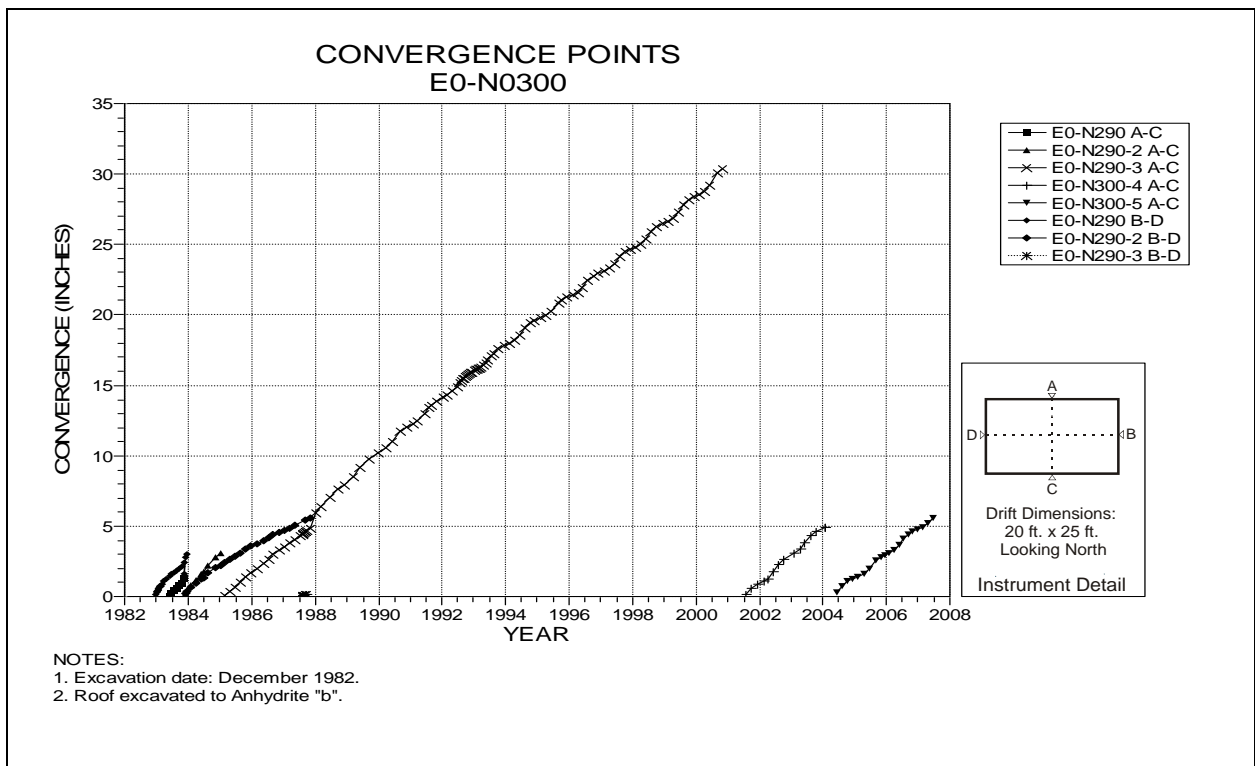


Figure 4-138 Convergence Point Array  
E0 Drift at N300 – All Chords

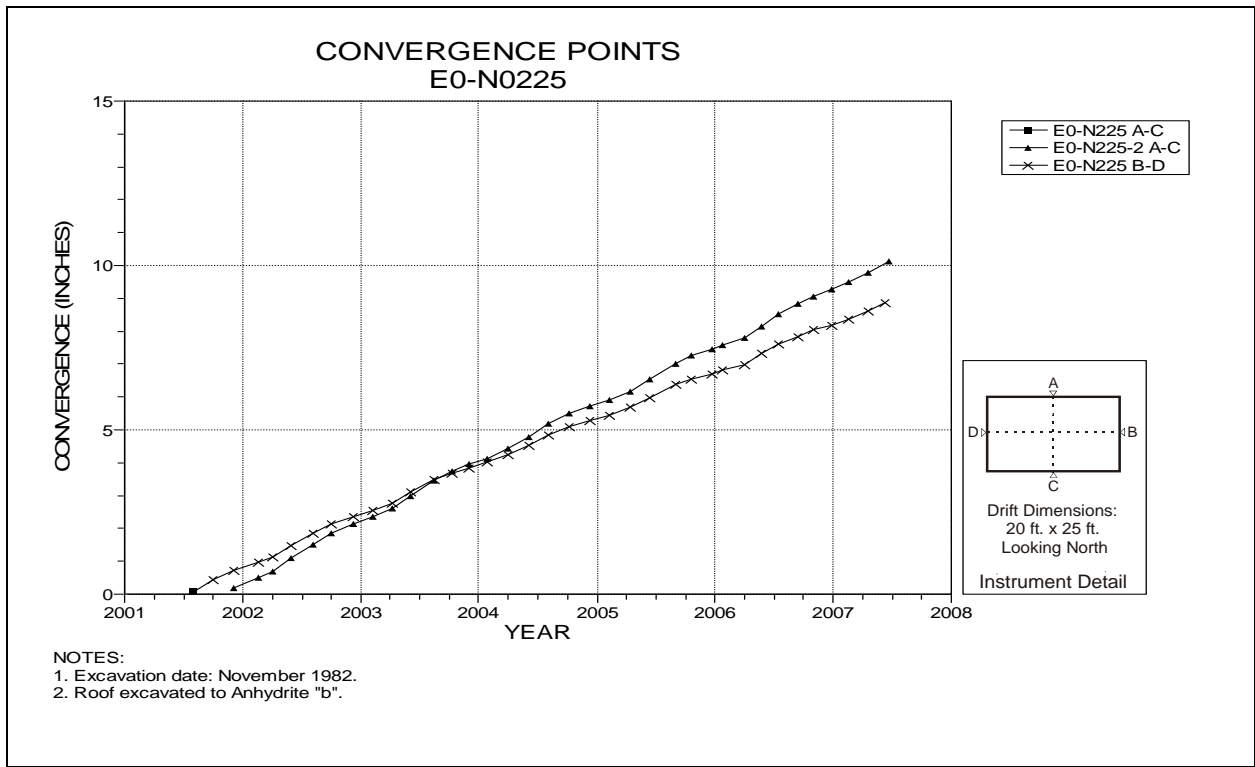


Figure 4-139 Convergence Point Array  
E0 Drift at N225 – All Chords

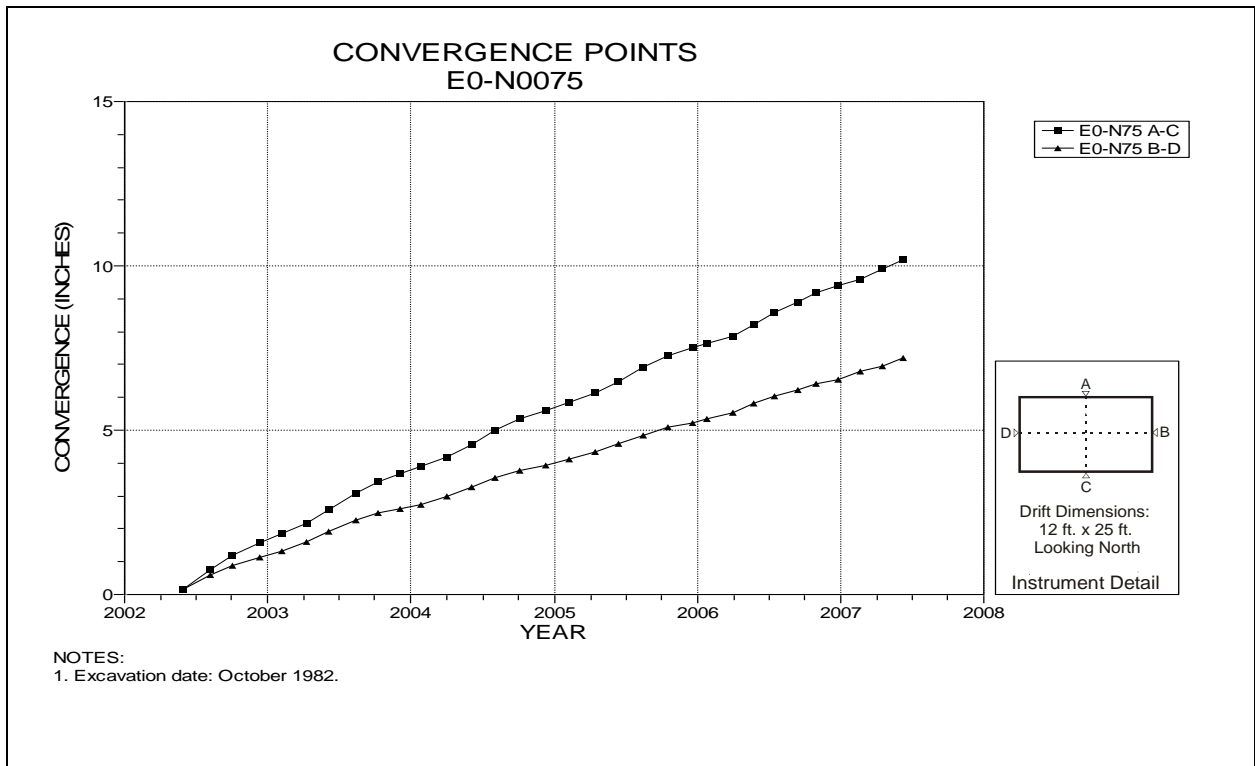


Figure 4-140 Convergence Point Array  
E0 Drift at N75 – All Chords

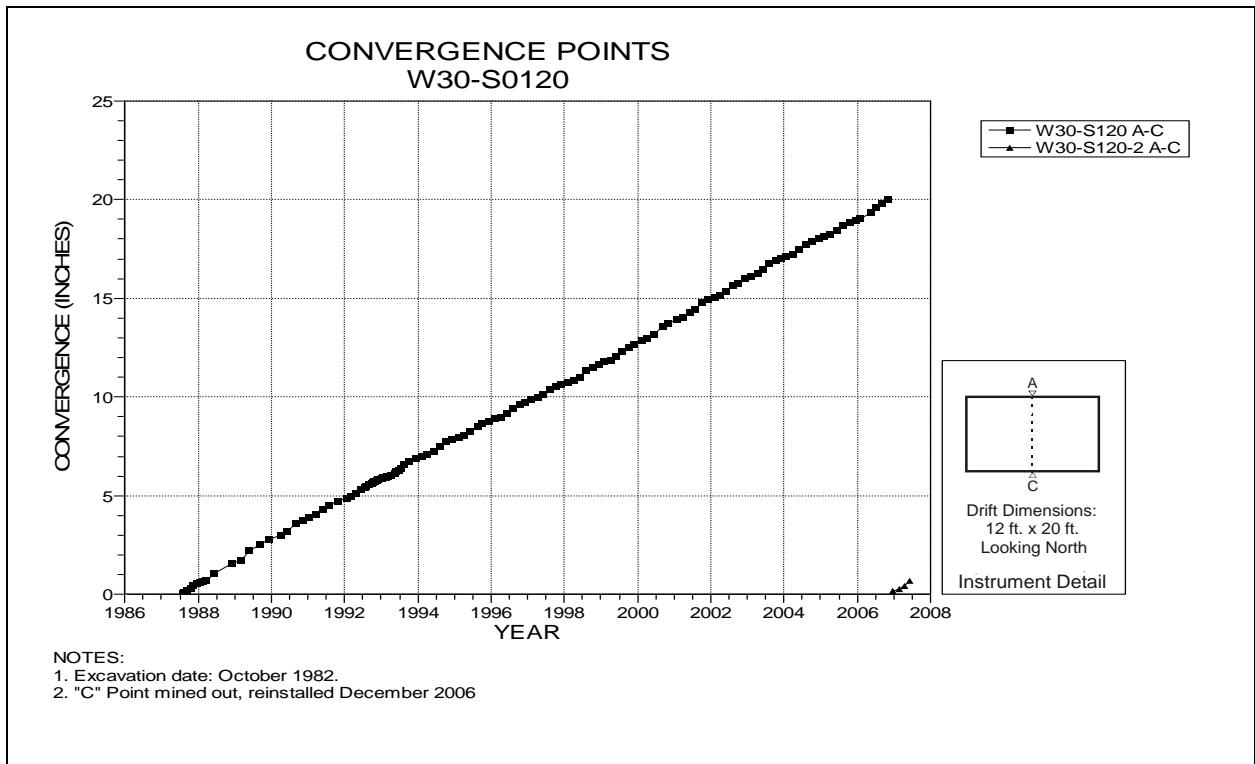


Figure 4-141 Convergence Point Array  
W30 Drift at S120 – Roof to Floor

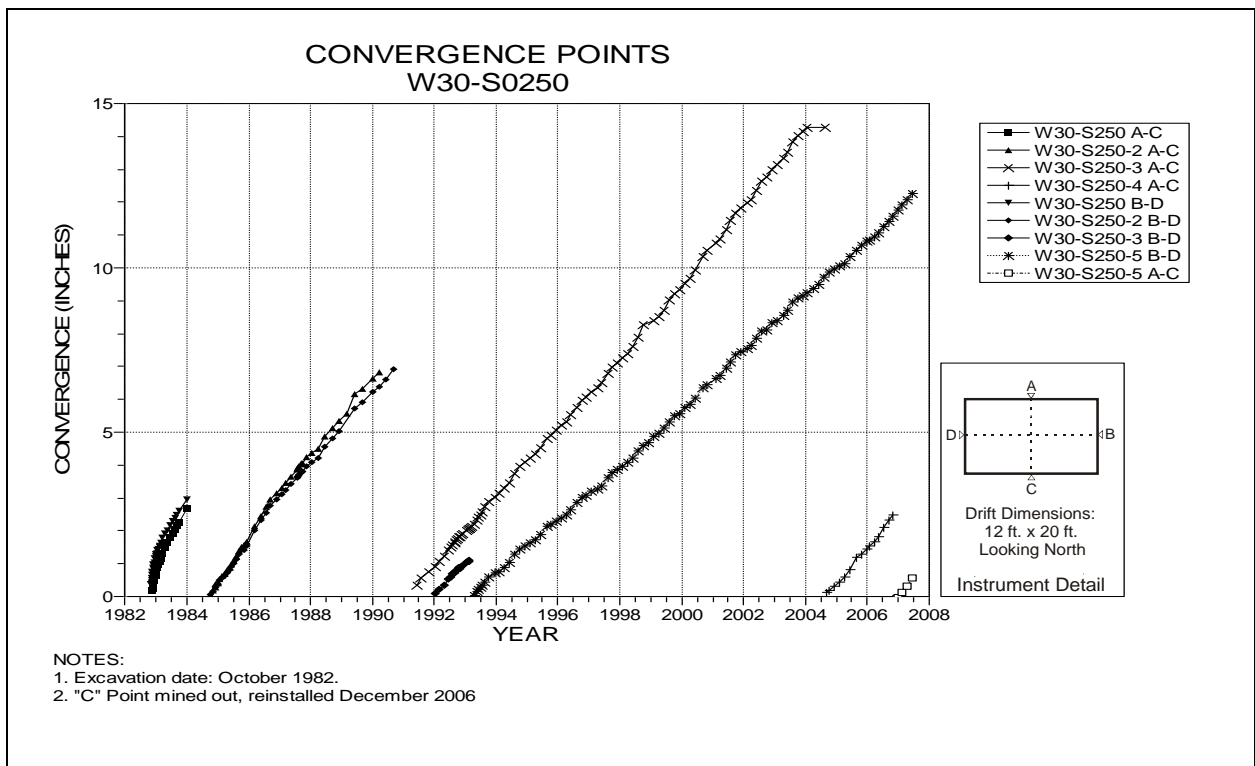


Figure 4-142 Convergence Point Array  
W30 Drift at S250 – All Chords

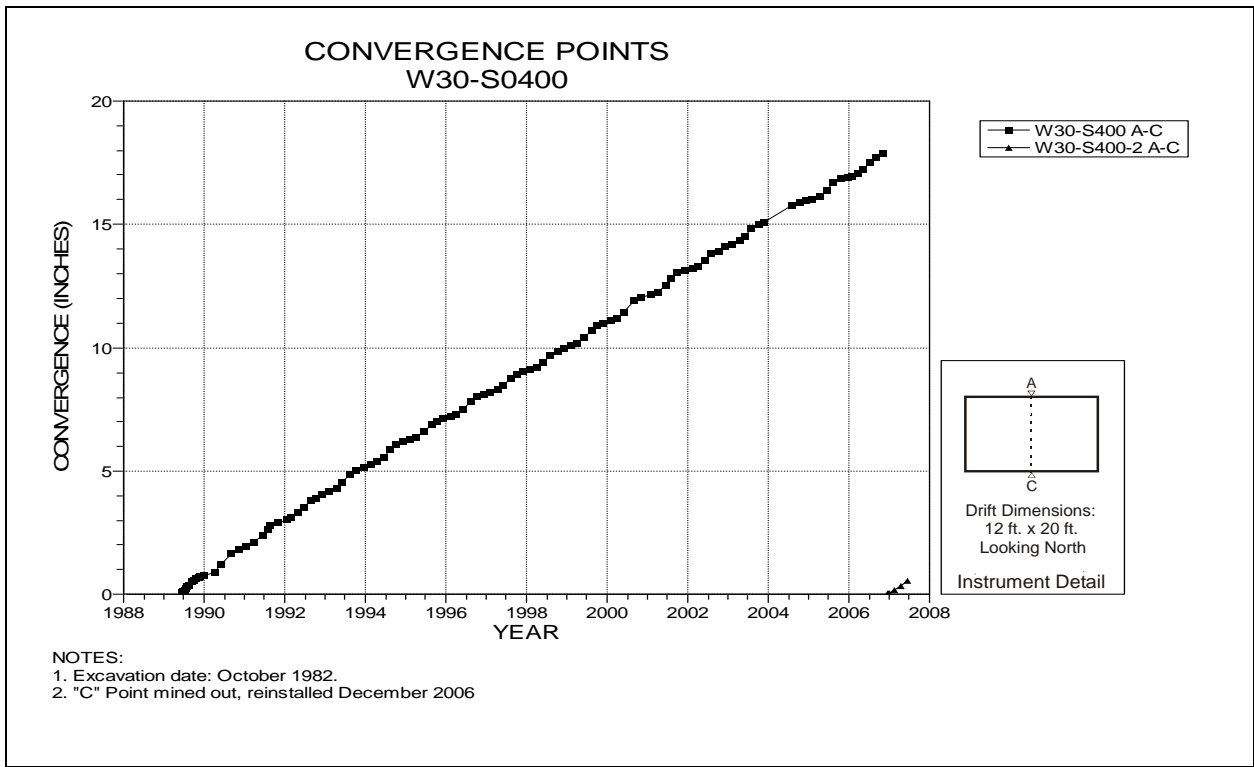


Figure 4-143 Convergence Point Array  
W30 Drift at S400 Drift Intersection – Roof to Floor

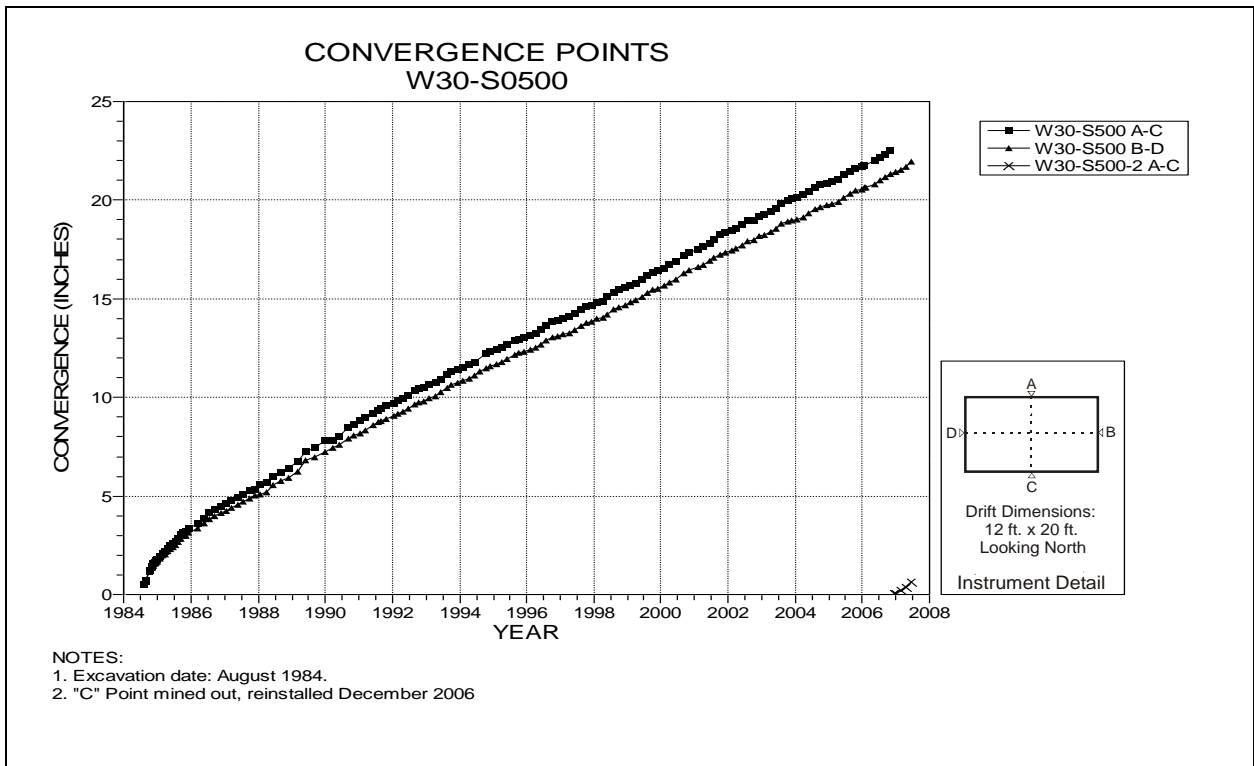


Figure 4-144 Convergence Point Array  
W30 Drift at S500 – All Chords

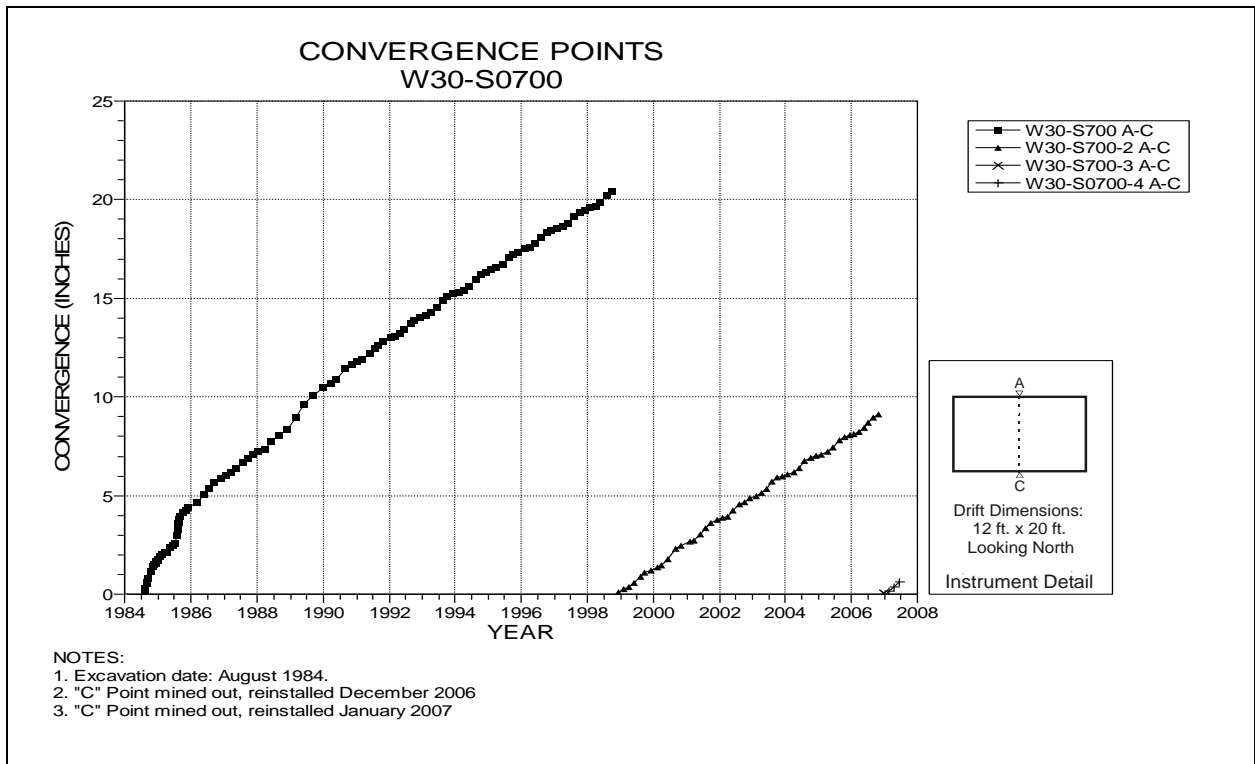


Figure 4-145 Convergence Point Array  
W30 Drift at S700 Drift Intersection – Roof to Floor

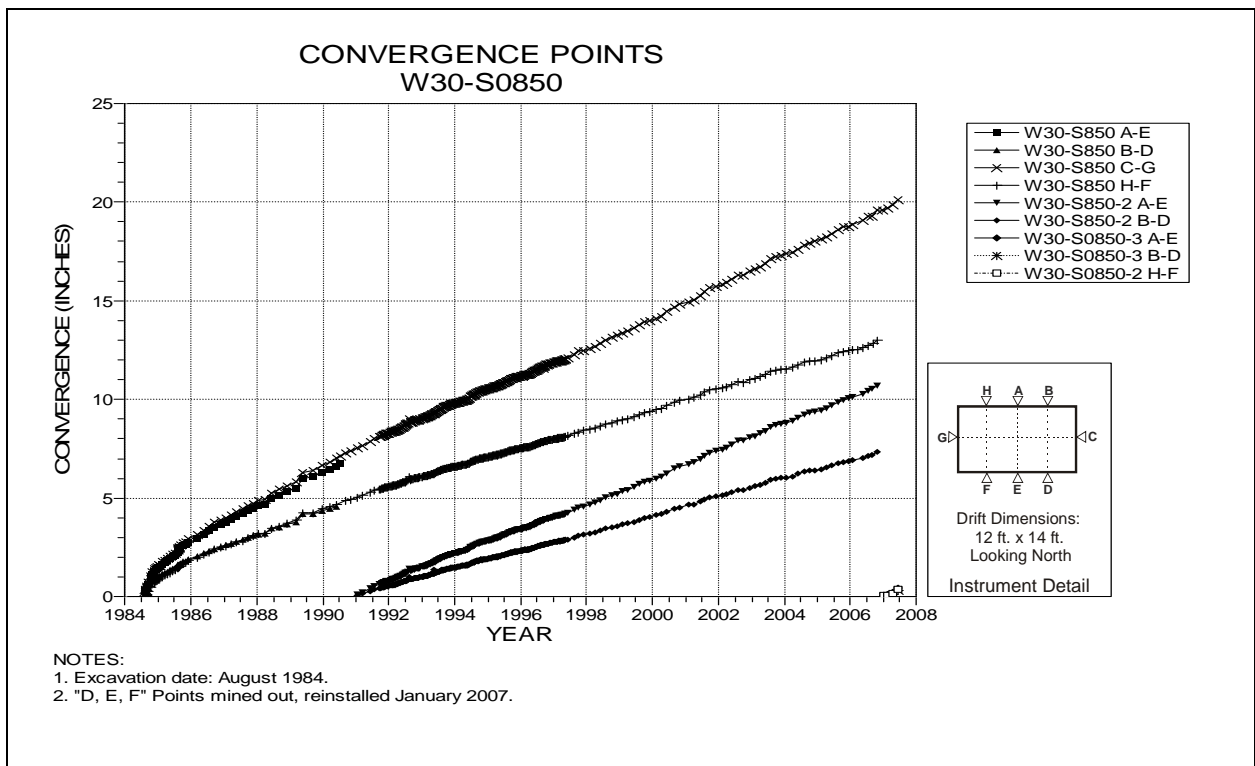


Figure 4-146 Convergence Point Array  
W30 Drift at S850 – All Chords

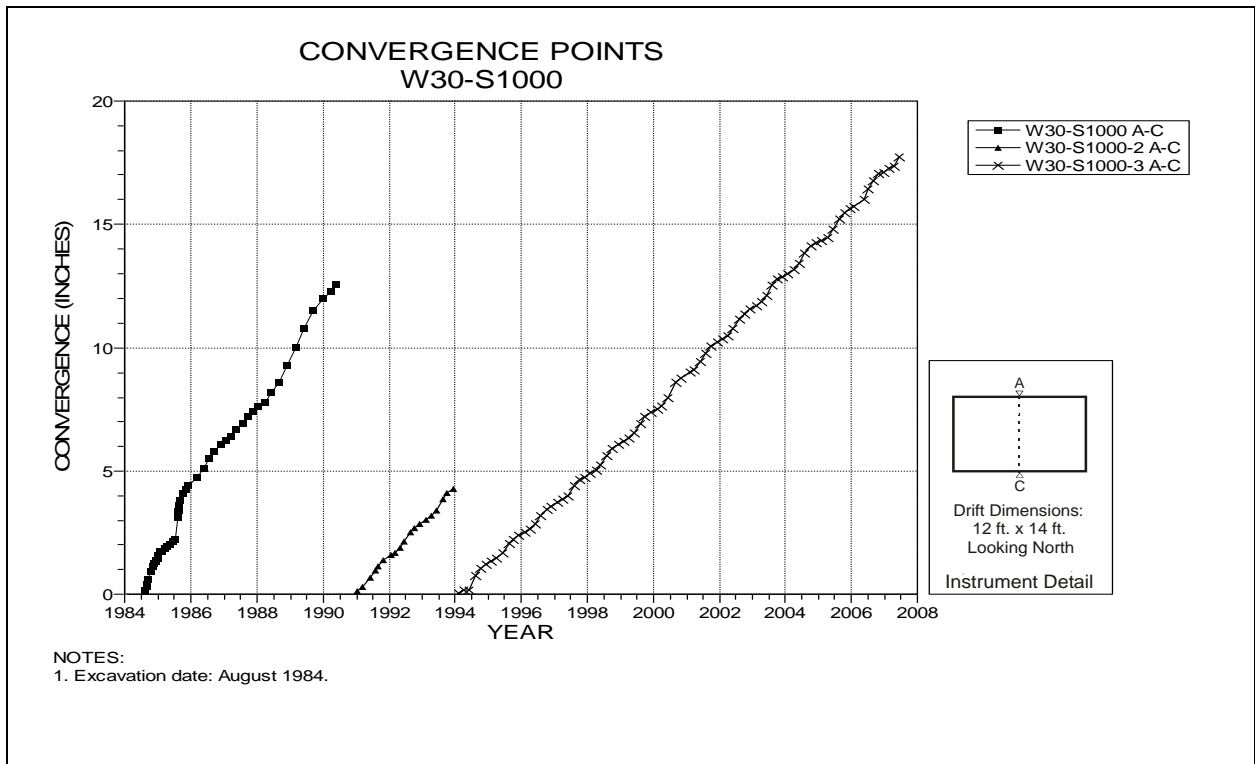


Figure 4-147 Convergence Point Array  
W30 Drift at S1000 Drift Intersection – Roof to Floor

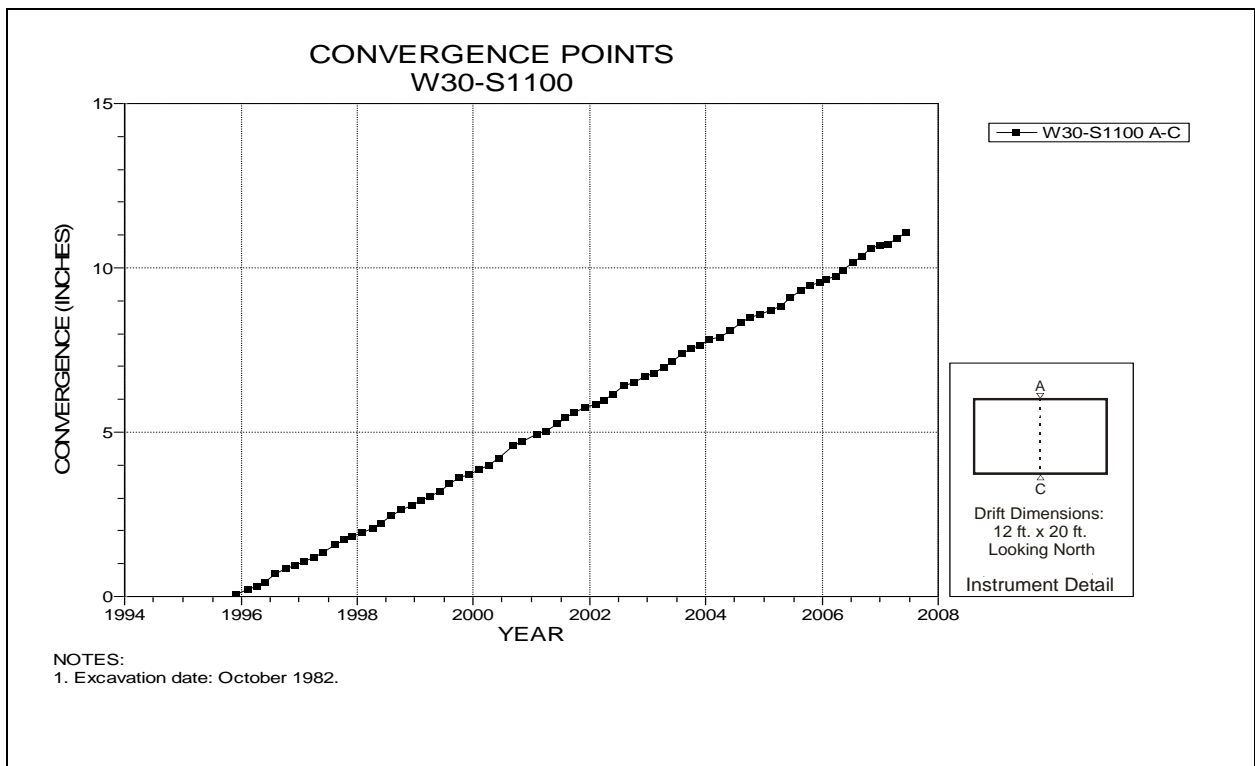


Figure 4-148 Convergence Point Array  
W30 Drift at S1100 – Roof to Floor

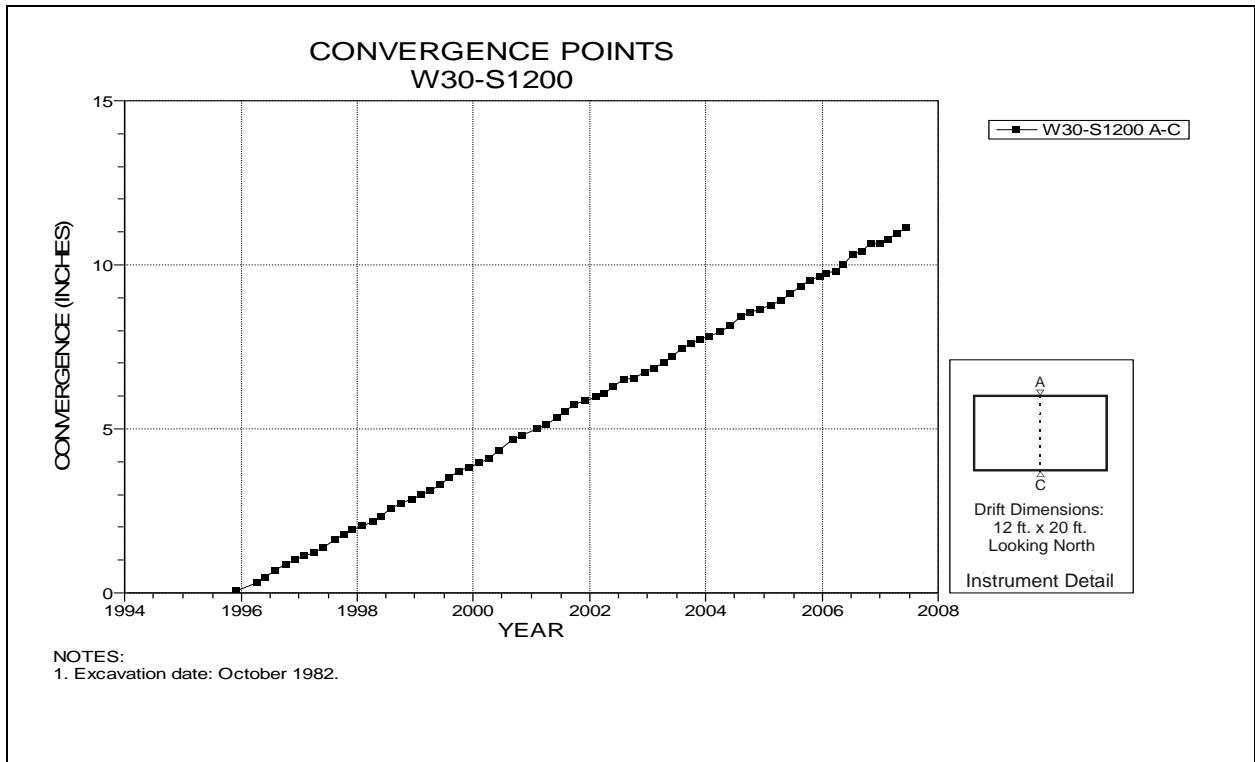


Figure 4-149 Convergence Point Array  
W30 Drift at S1200 – Roof to Floor

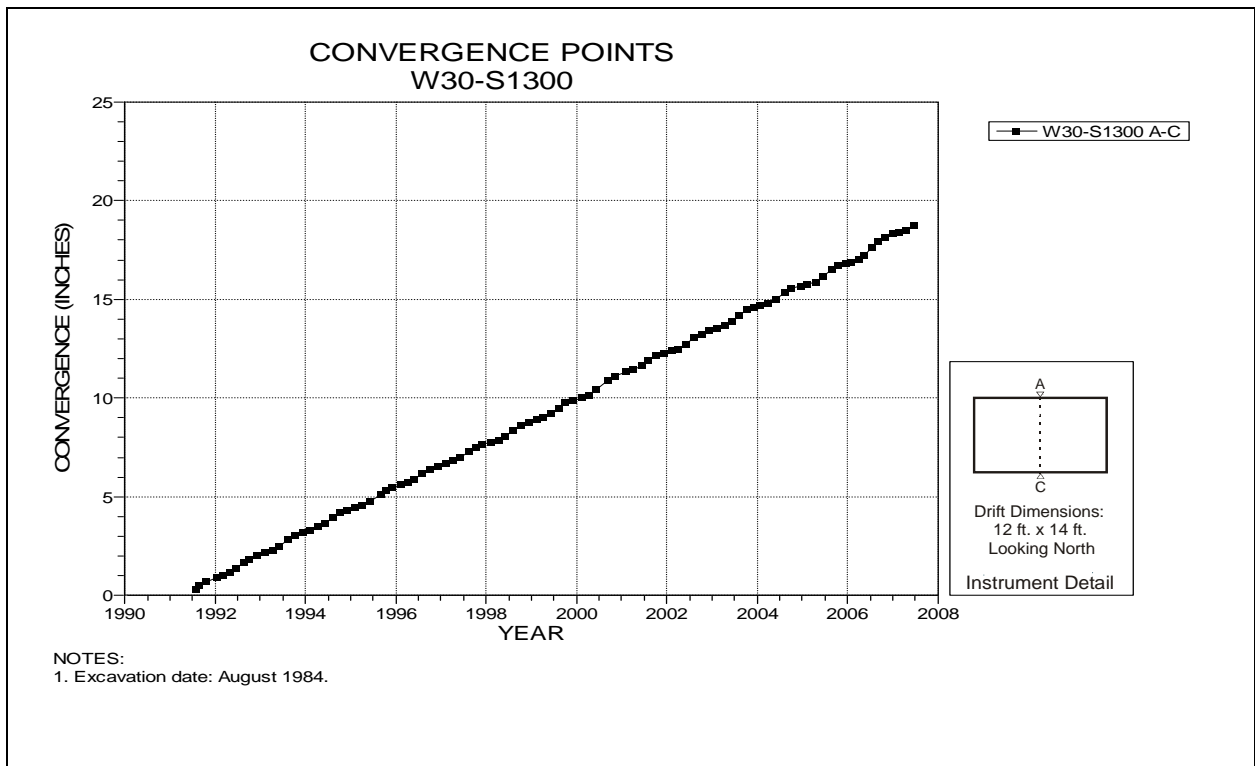


Figure 4-150 Convergence Point Array  
W30 Drift at S1300 Drift Intersection – Roof to Floor

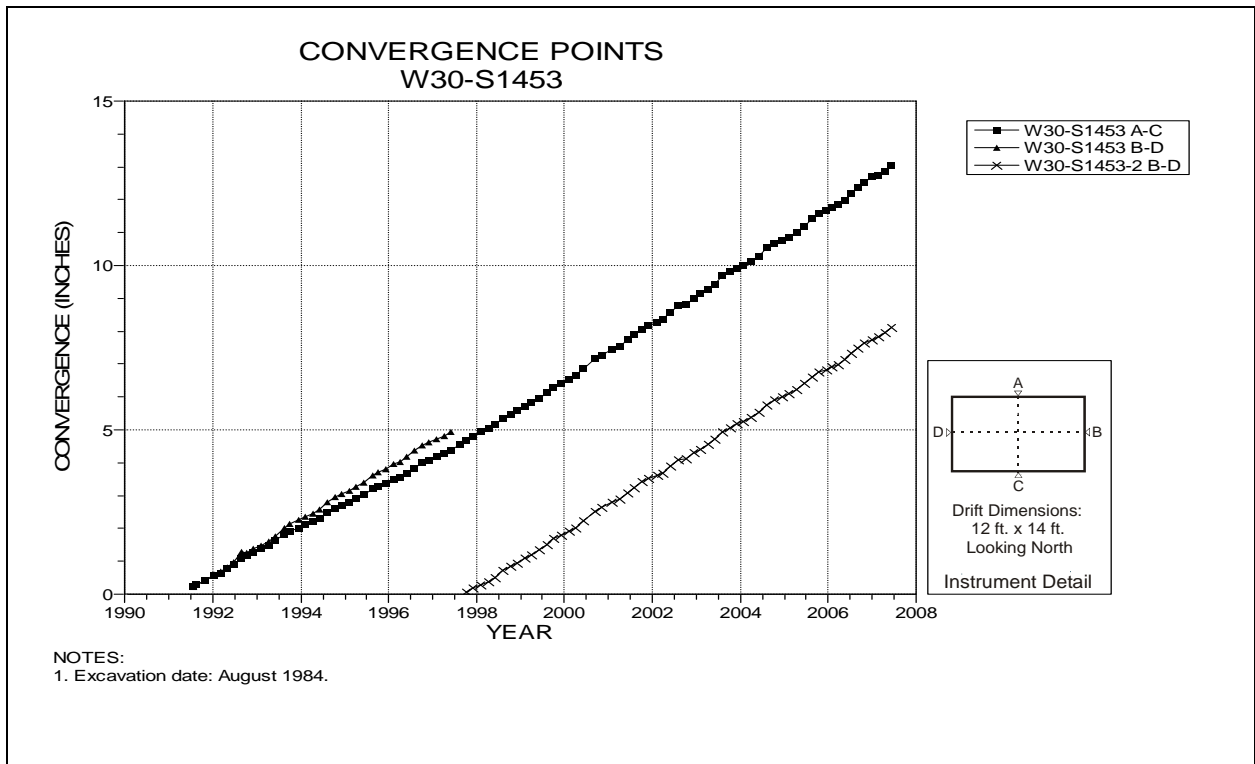


Figure 4-151 Convergence Point Array  
W30 Drift at S1453 – All Chords

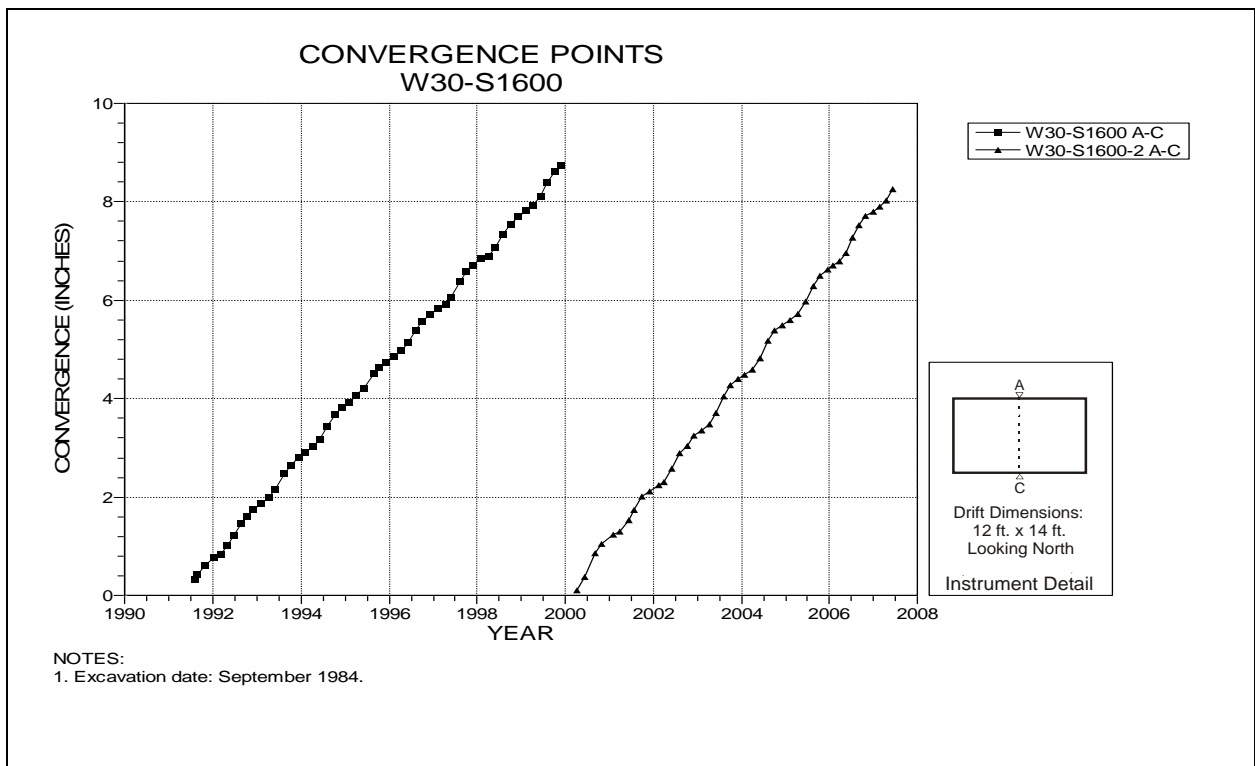


Figure 4-152 Convergence Point Array  
W30 Drift at S1600 Drift Intersection – Roof to Floor



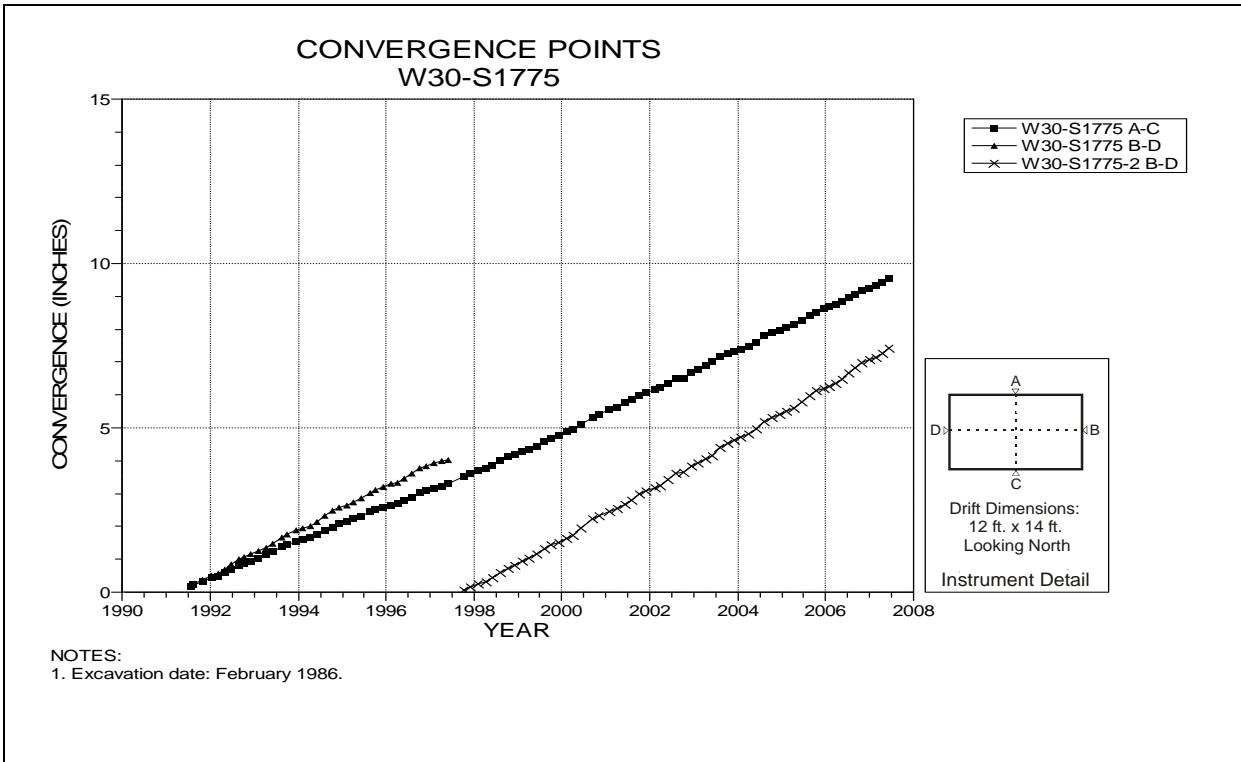


Figure 4-153 Convergence Point Array  
W30 Drift at S1775 – All Chords

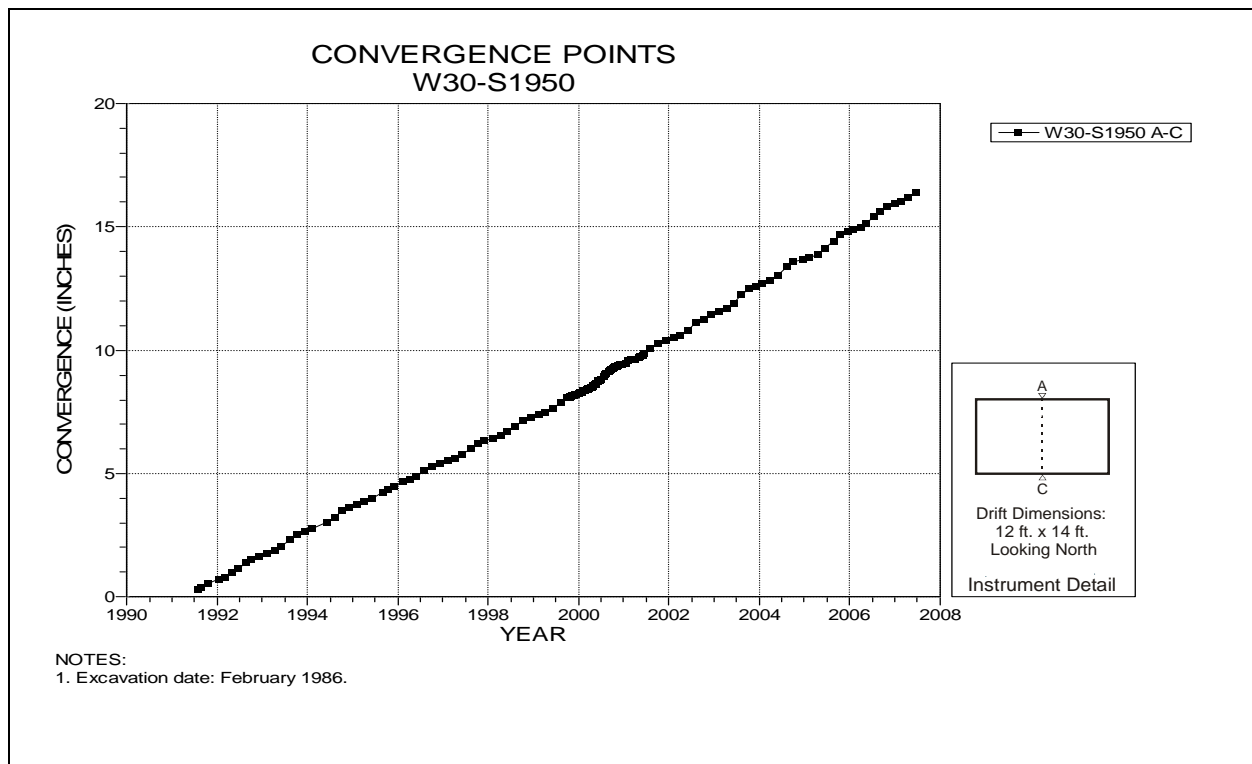


Figure 4-154 Convergence Point Array  
W30 Drift at S1950 Drift Intersection – Roof to Floor

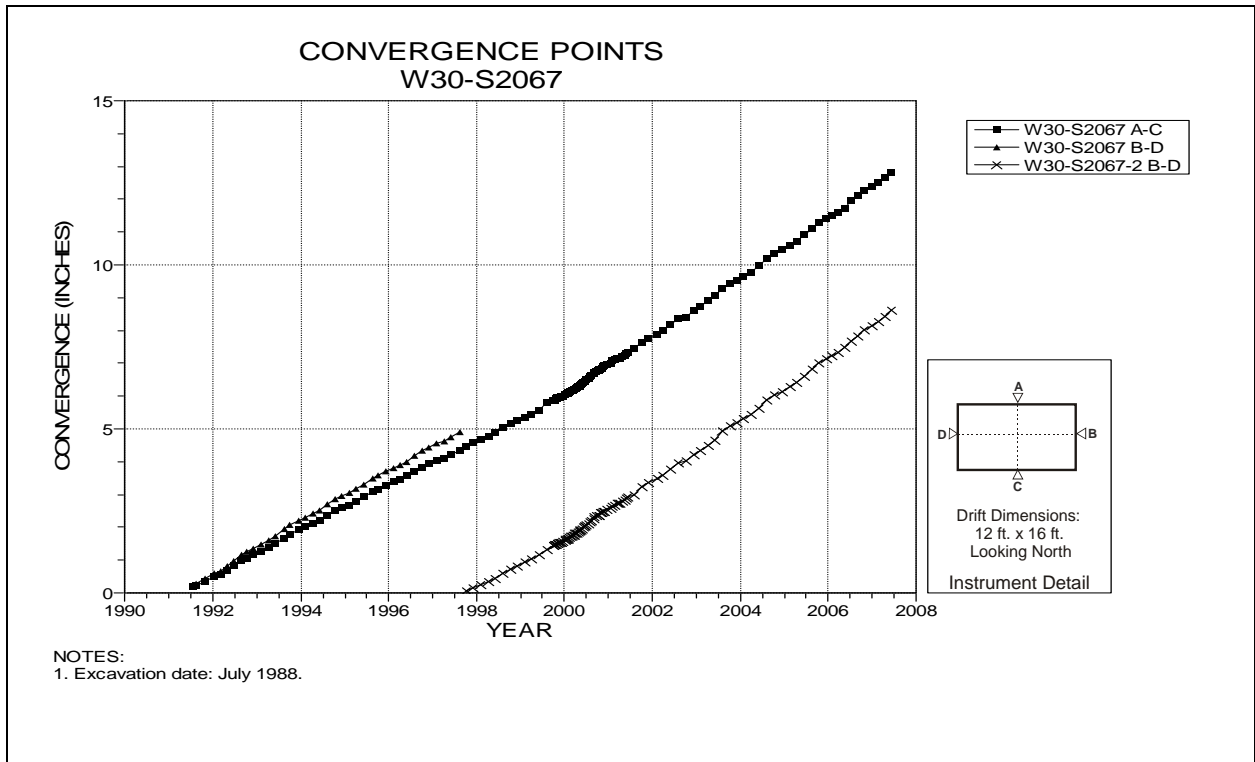


Figure 4-155 Convergence Point Array  
W30 Drift at S2067 – All Chords

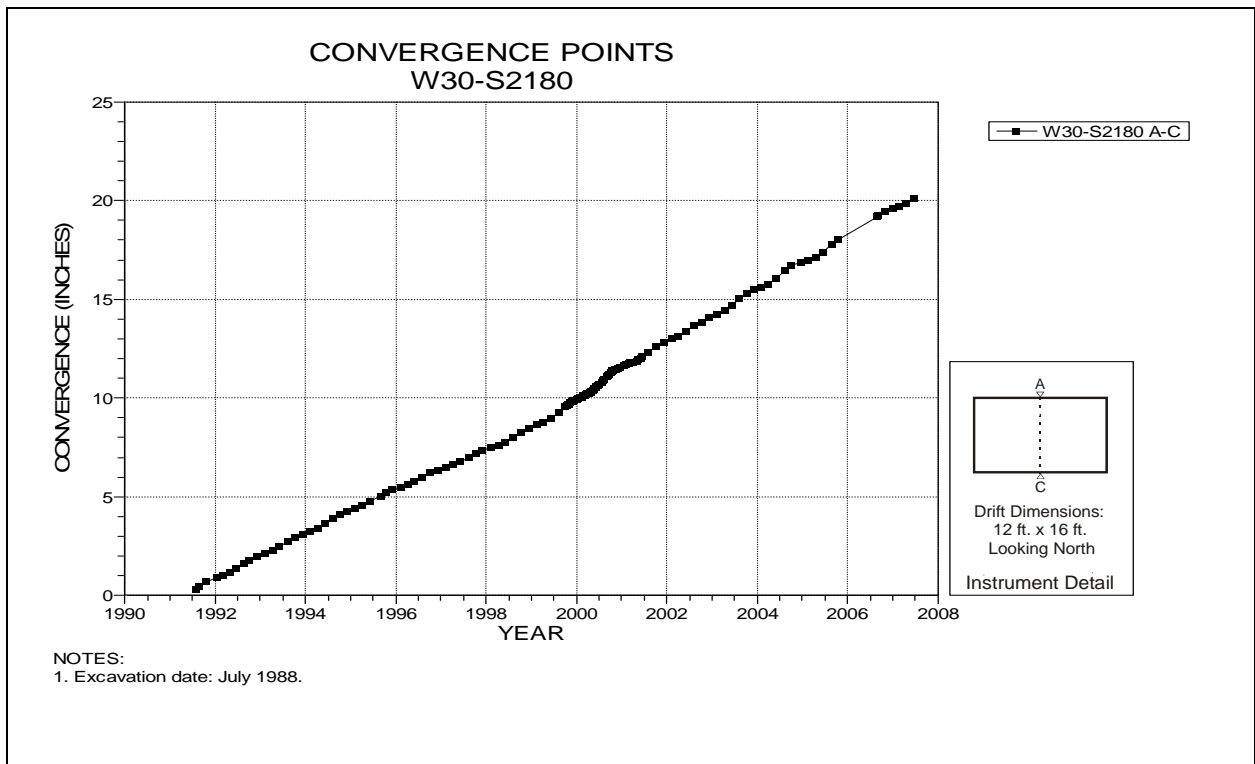


Figure 4-156 Convergence Point Array  
W30 Drift at S2180 Drift Intersection – Roof to Floor

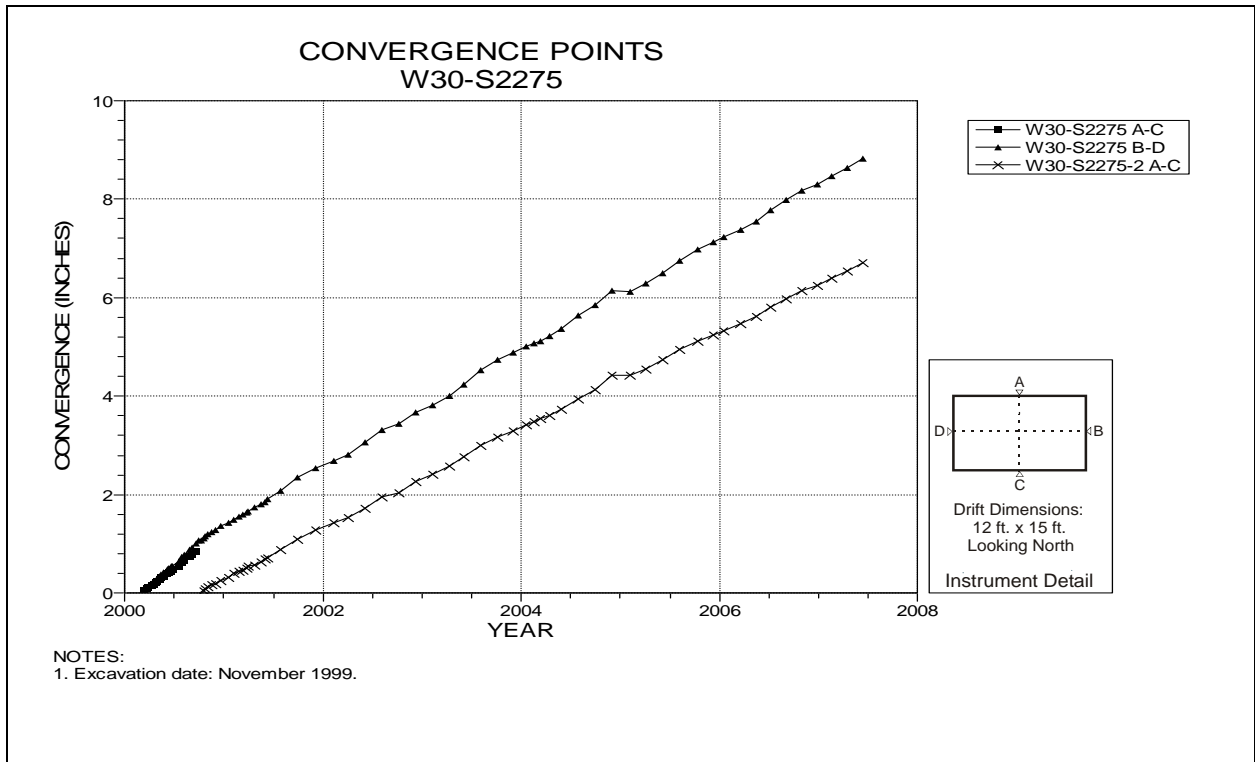


Figure 4-157 Convergence Point Array  
W30 Drift at S2275 – All Chords

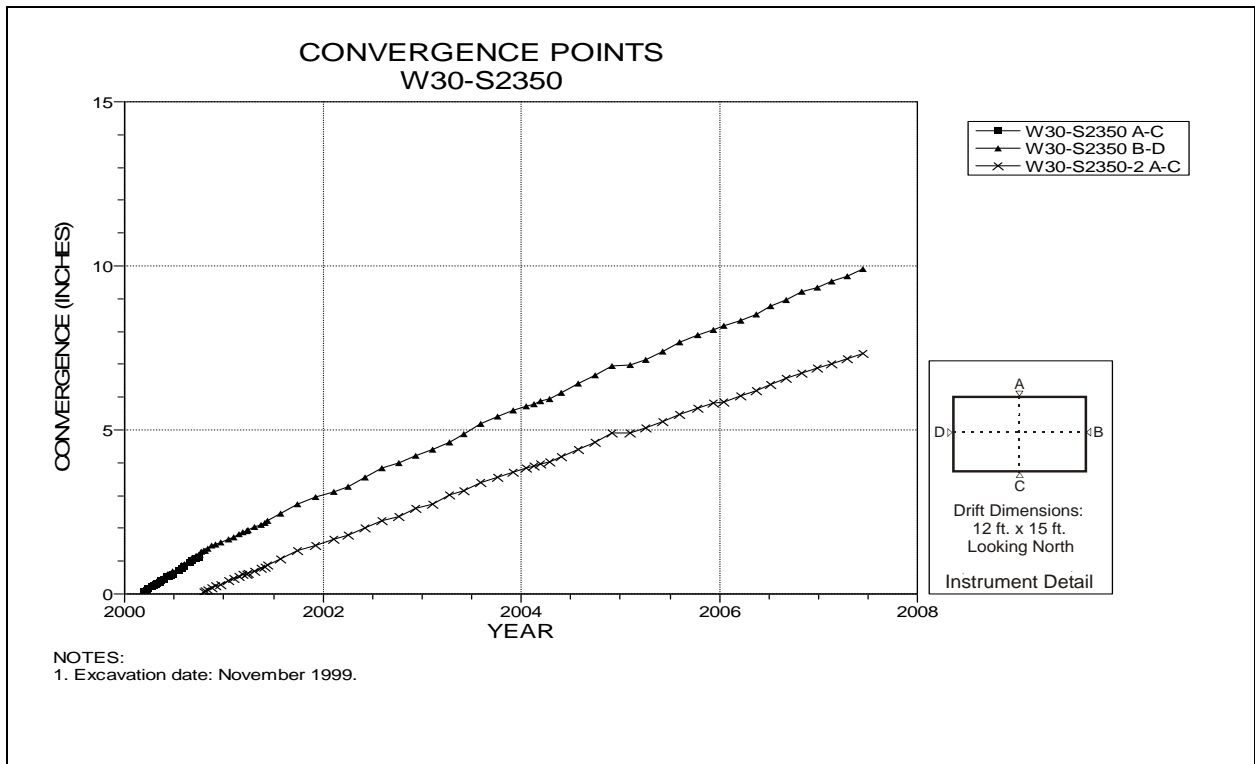


Figure 4-158 Convergence Point Array  
W30 Drift at S2350 – All Chords

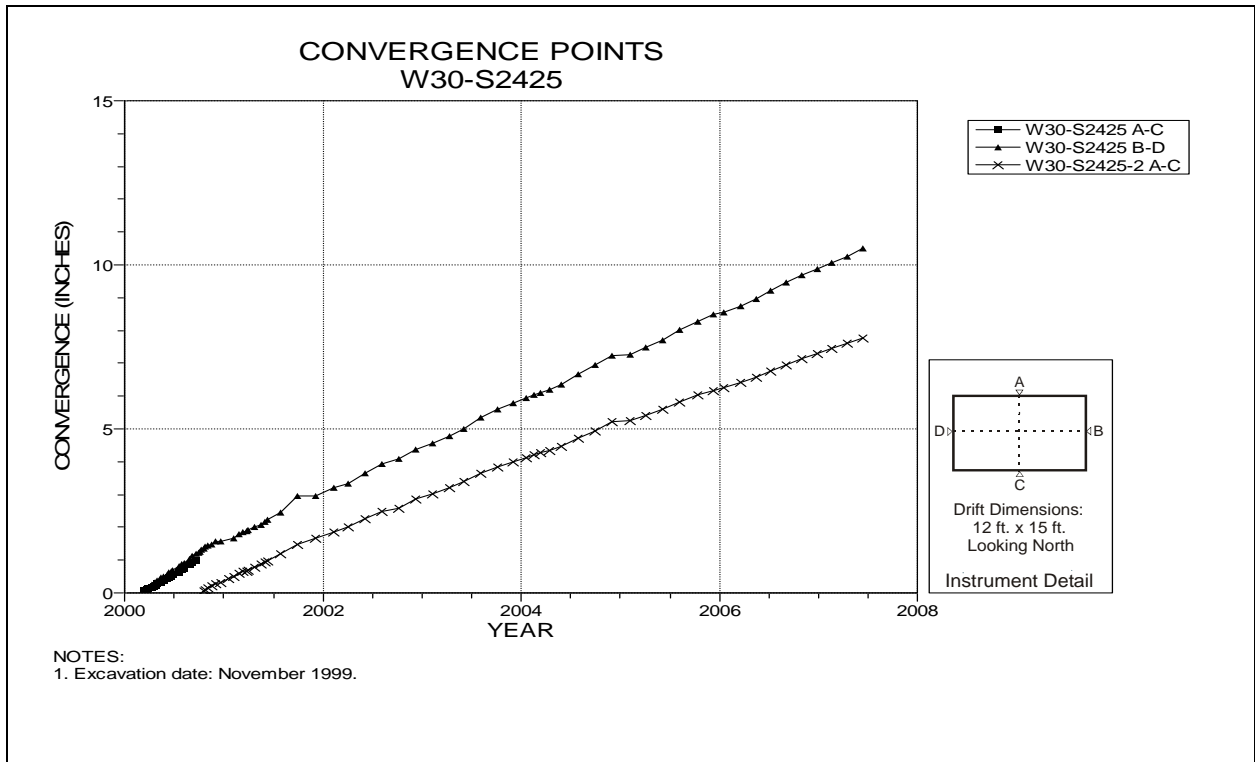


Figure 4-159 Convergence Point Array  
W30 Drift at S2425 – All Chords

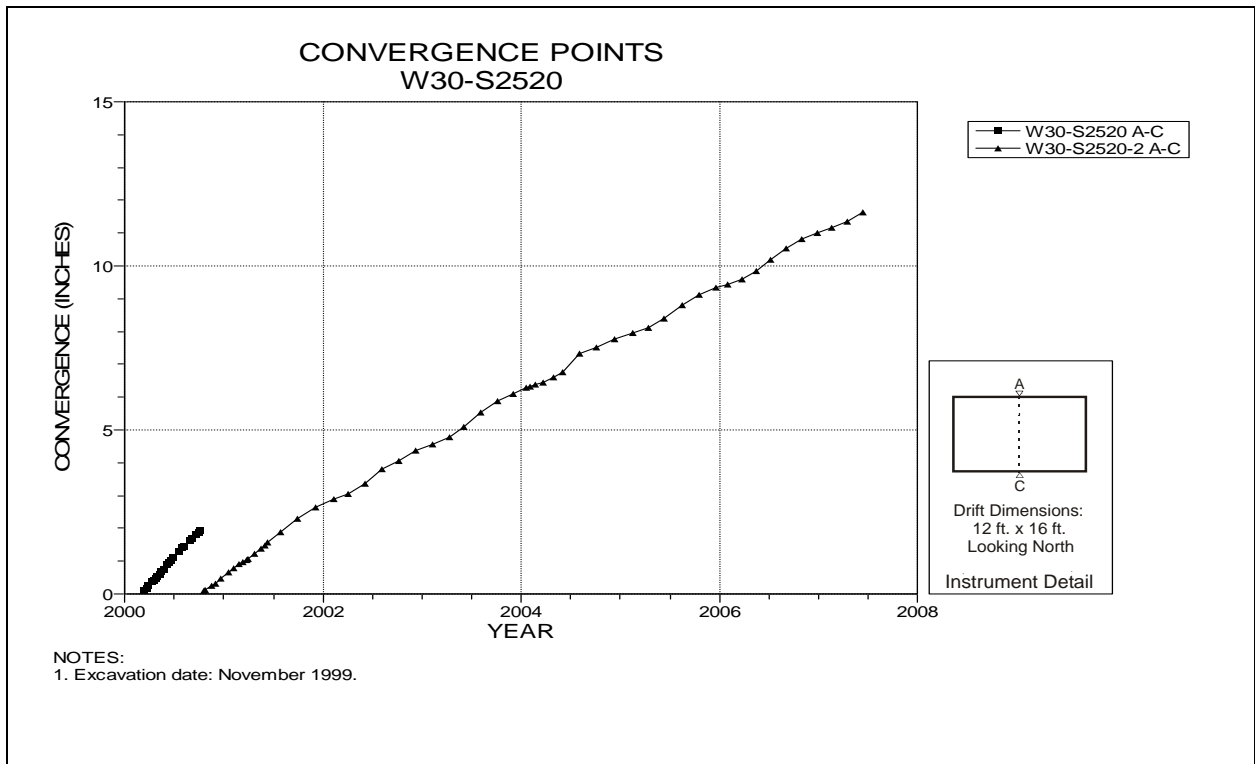


Figure 4-160 Convergence Point Array  
W30 Drift at S2520 Drift Intersection – Roof to Floor

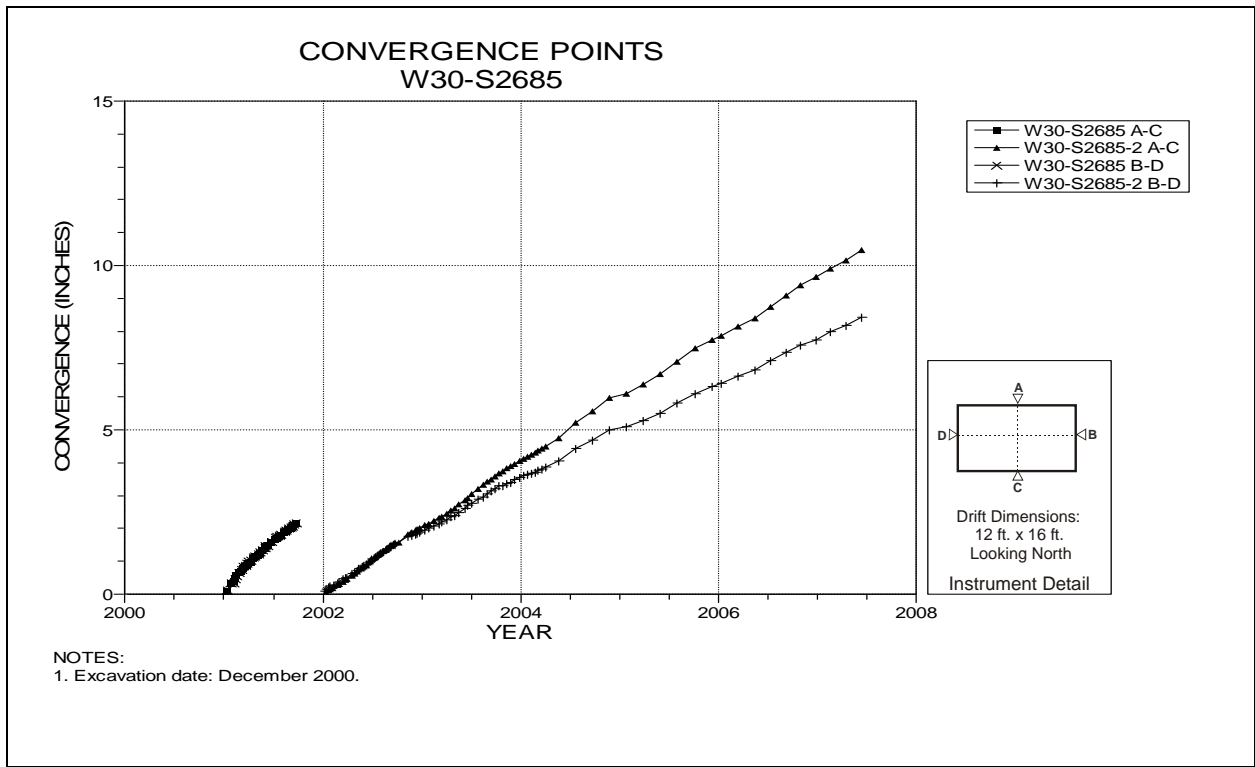


Figure 4-161 Convergence Point Array  
W30 Drift at S2685 – All Chords

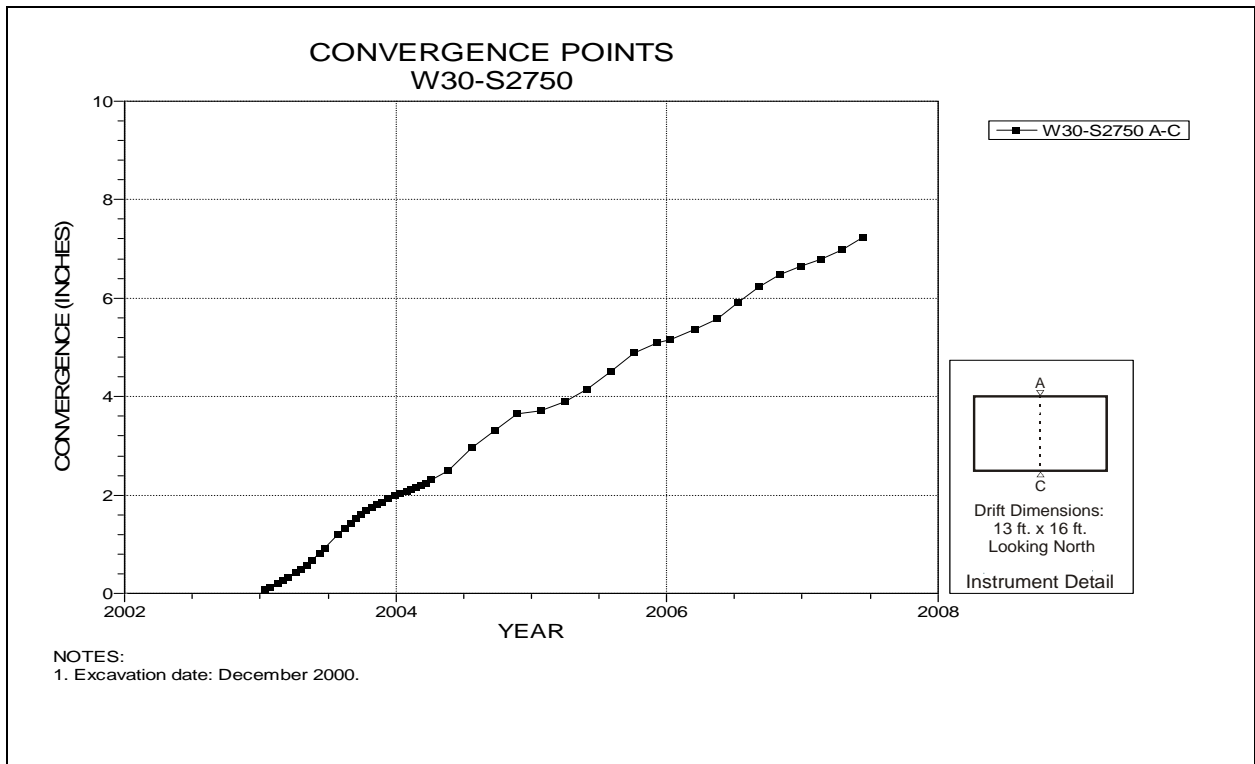


Figure 4-162 Convergence Point Array  
W30 Drift at S2750 Drift Intersection – Roof to Floor

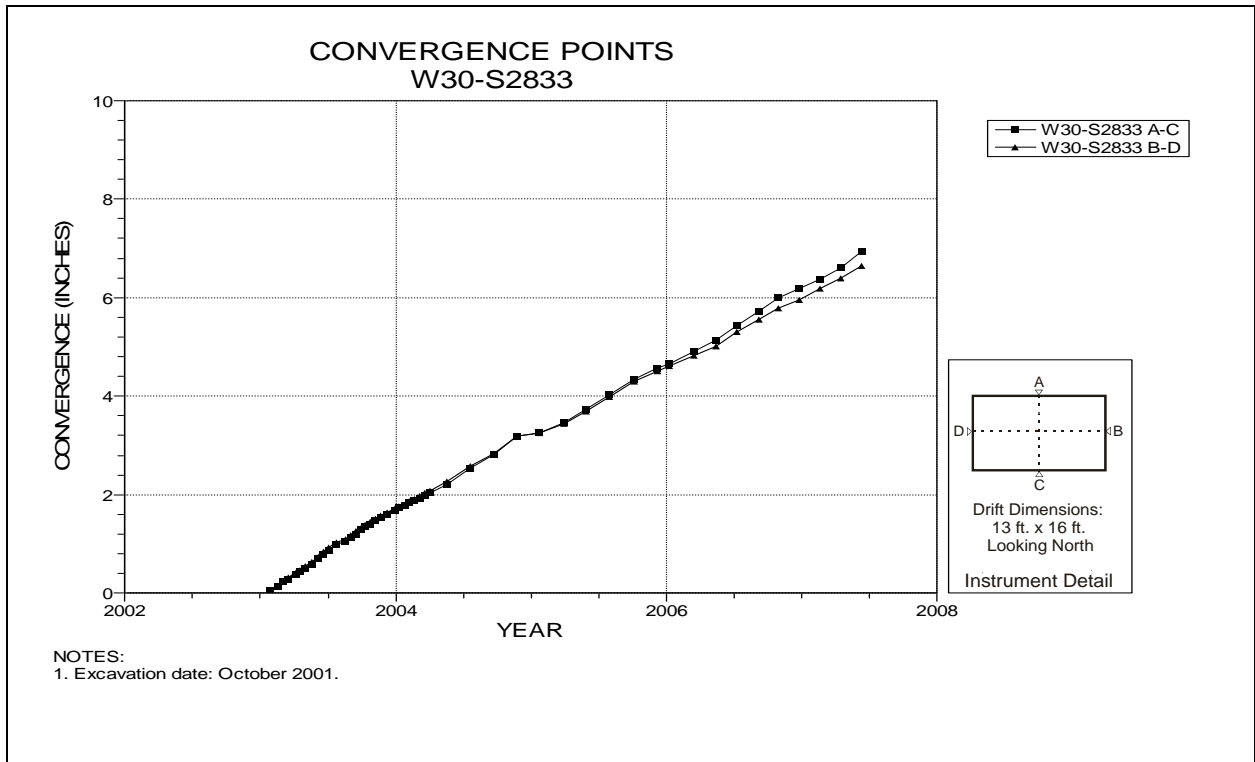


Figure 4-163 Convergence Point Array  
W30 Drift at S2833 – All Chords

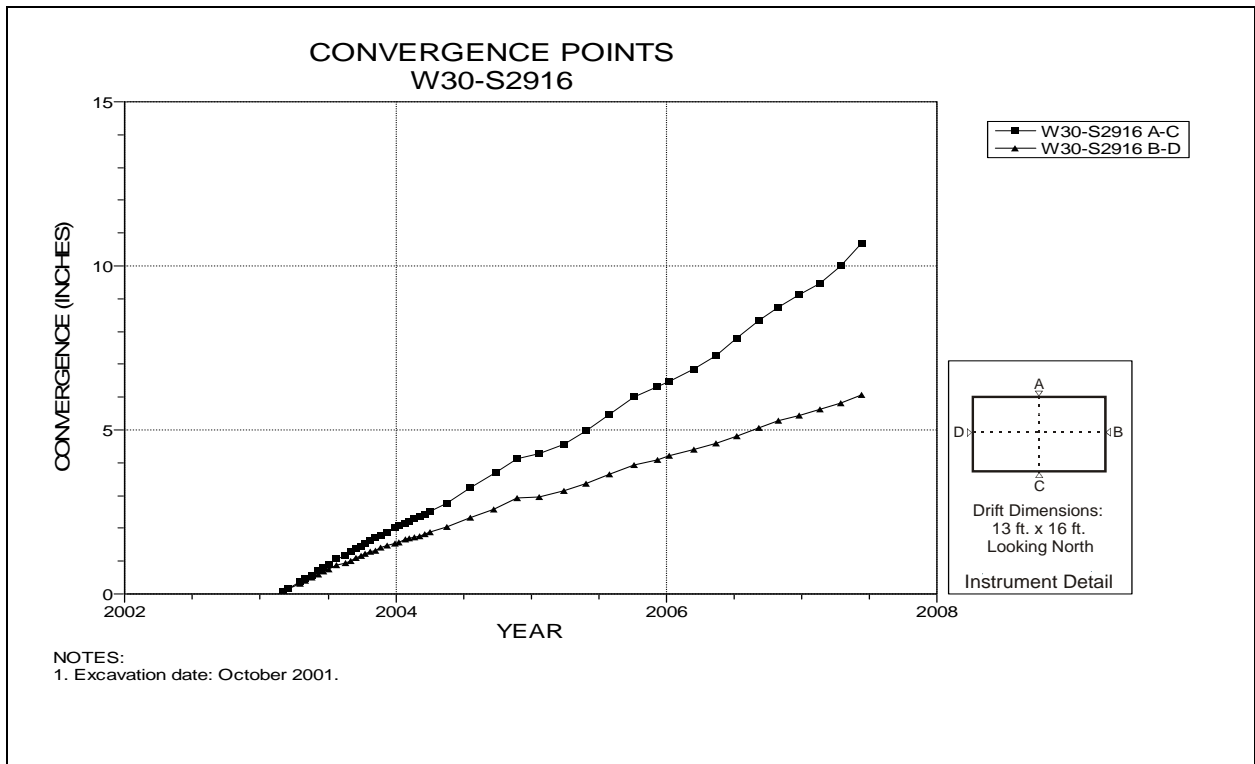


Figure 4-164 Convergence Point Array  
W30 Drift at S2916 – All Chords

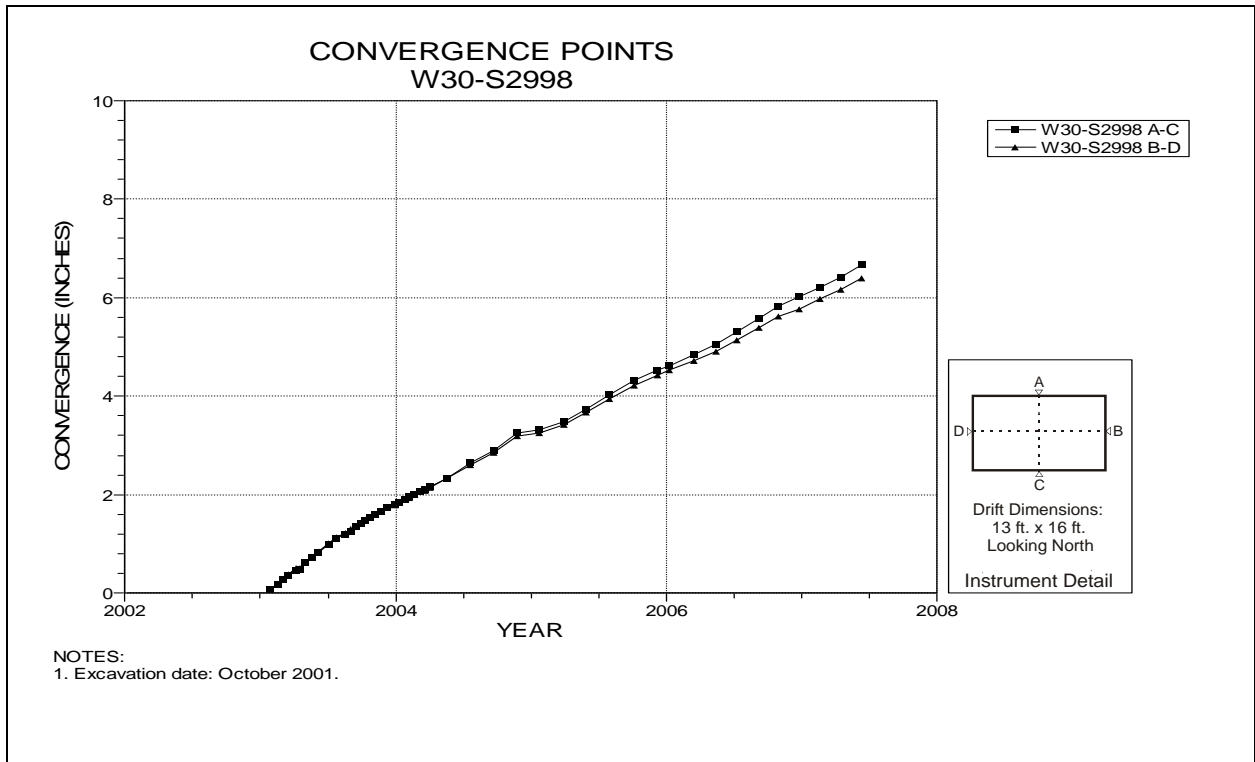


Figure 4-165 Convergence Point Array  
W30 Drift at S2998 – All Chords

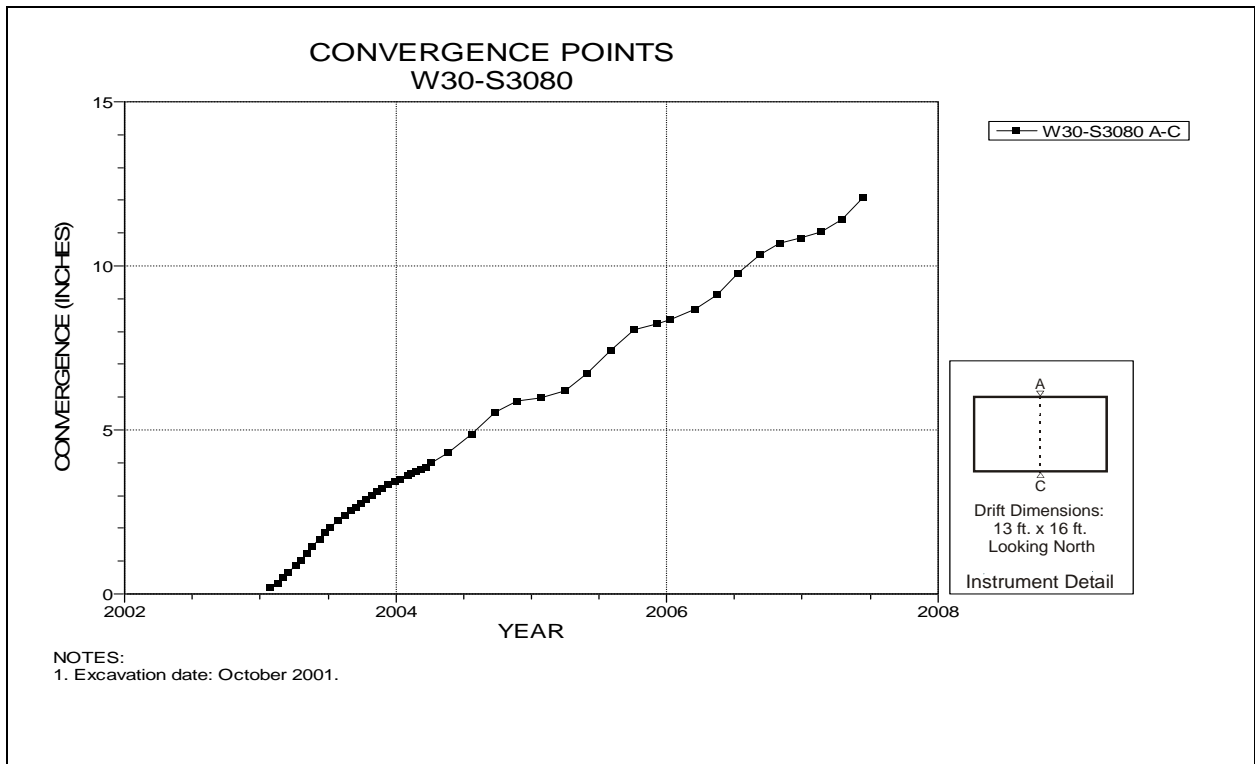


Figure 4-166 Convergence Point Array  
W30 Drift at S3080 Drift Intersection – Roof to Floor

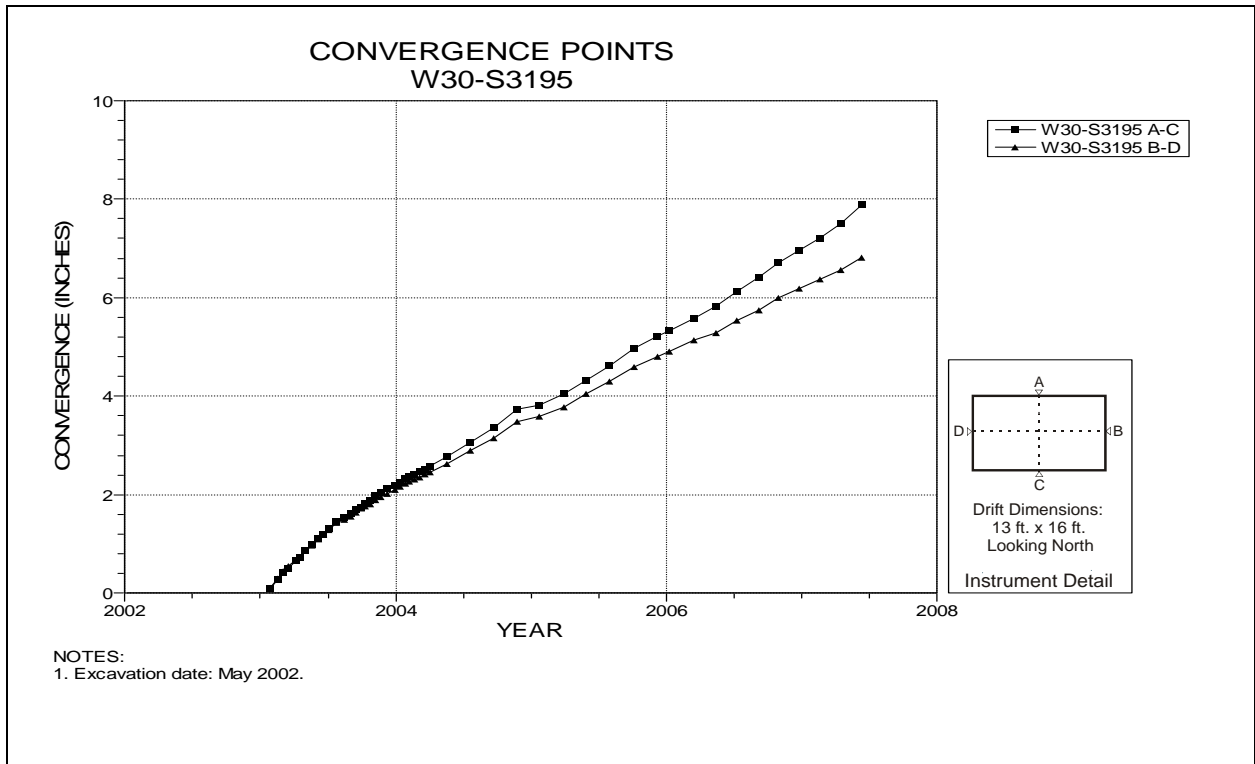


Figure 4-167 Convergence Point Array  
W30 Drift at S3195 – All Chords

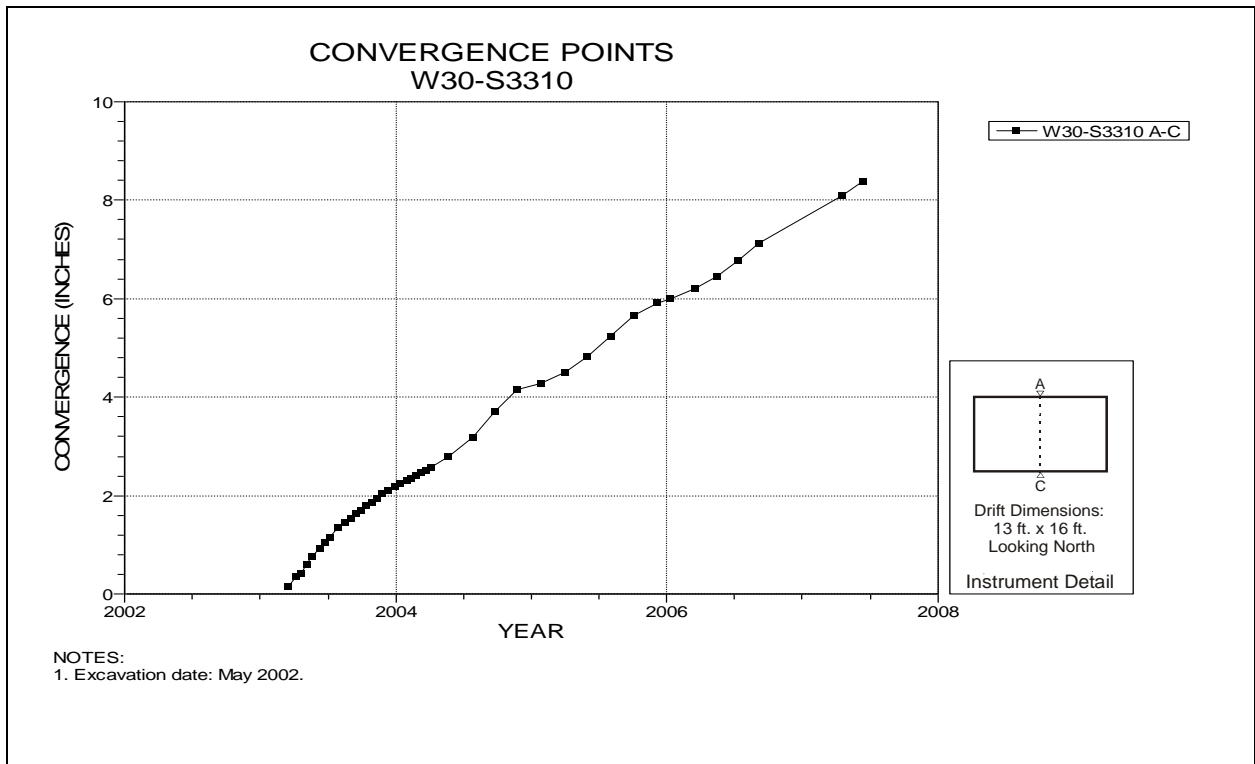


Figure 4-168 Convergence Point Array  
W30 Drift at S3310 Drift Intersection – Roof to Floor



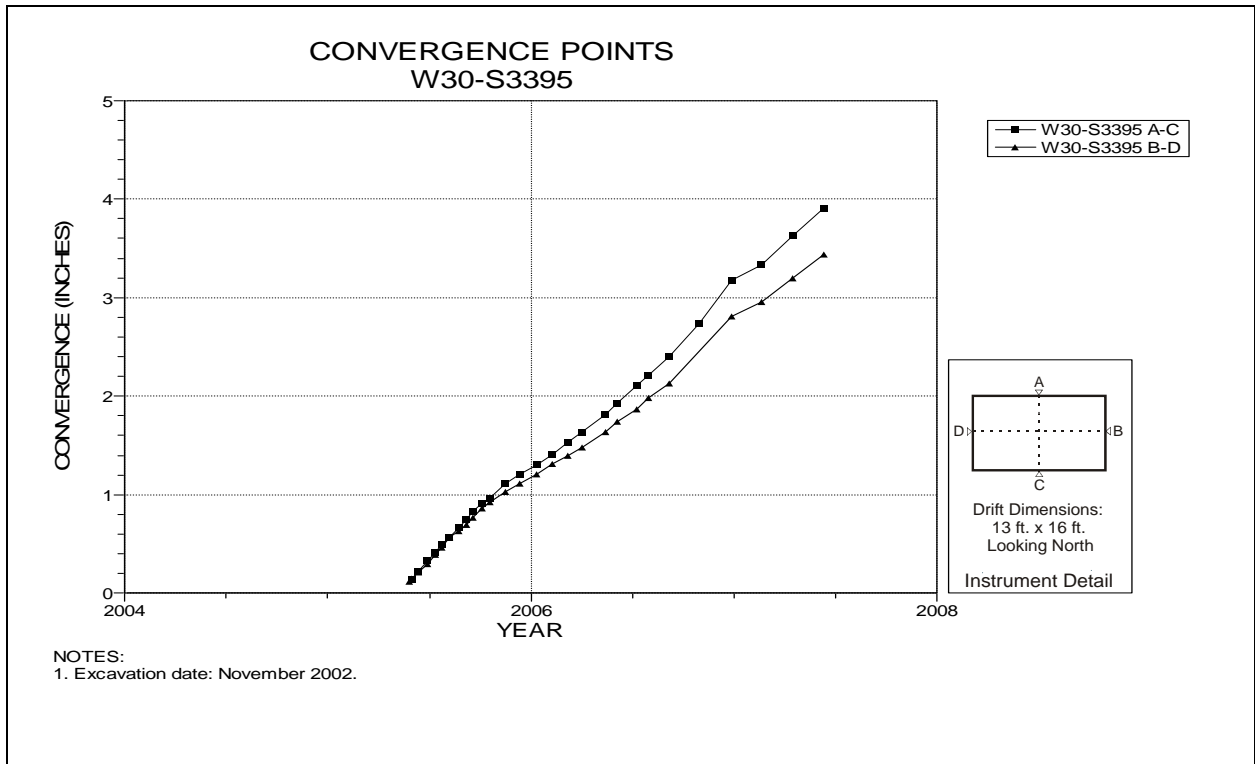


Figure 4-169 Convergence Point Array  
W30 Drift at S3395 – All Chords

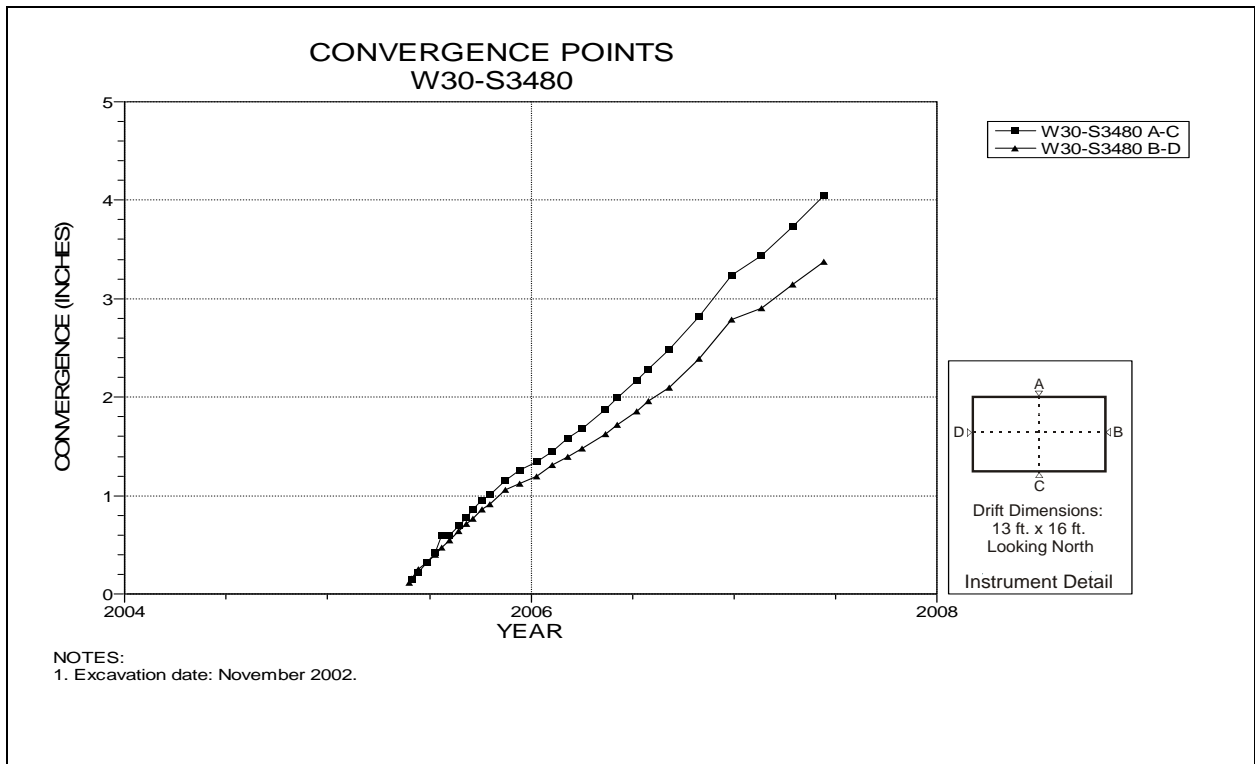


Figure 4-170 Convergence Point Array  
W30 Drift at S3480 – All Chords



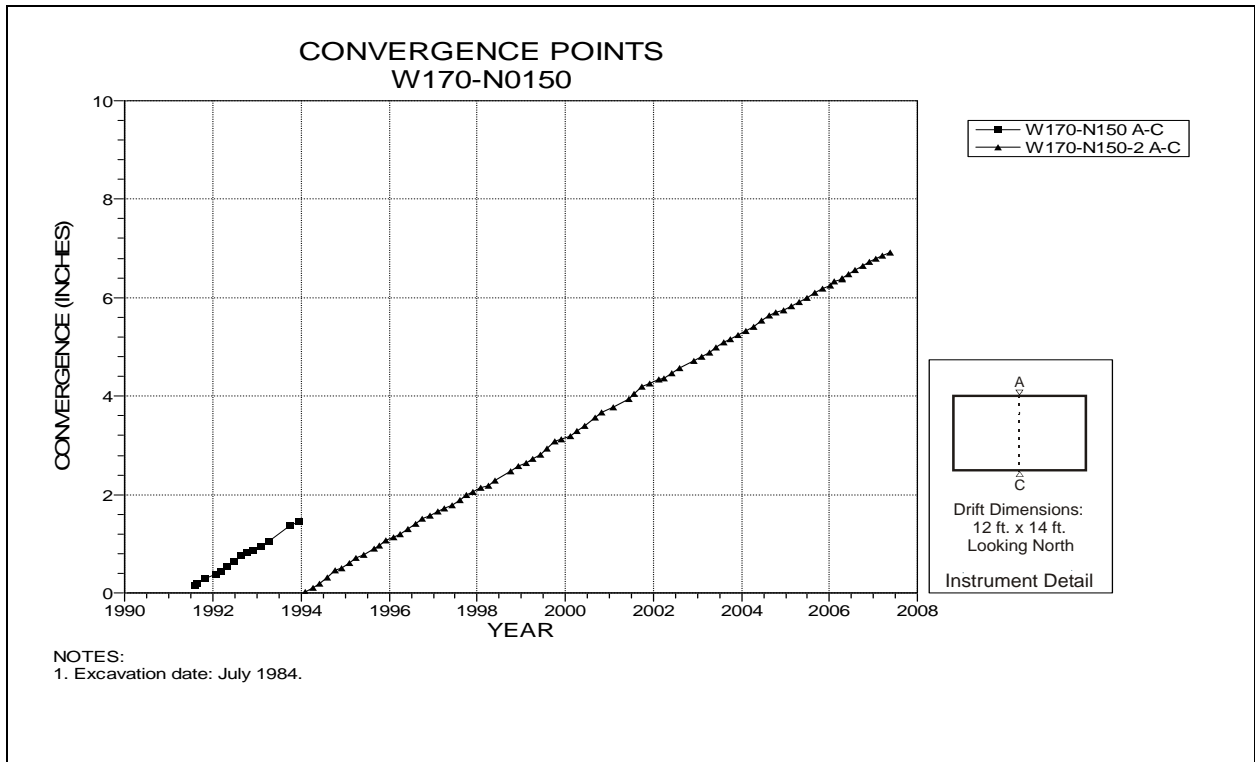


Figure 4-173 Convergence Point Array  
W170 Drift at N150 Drift Intersection – Roof to Floor

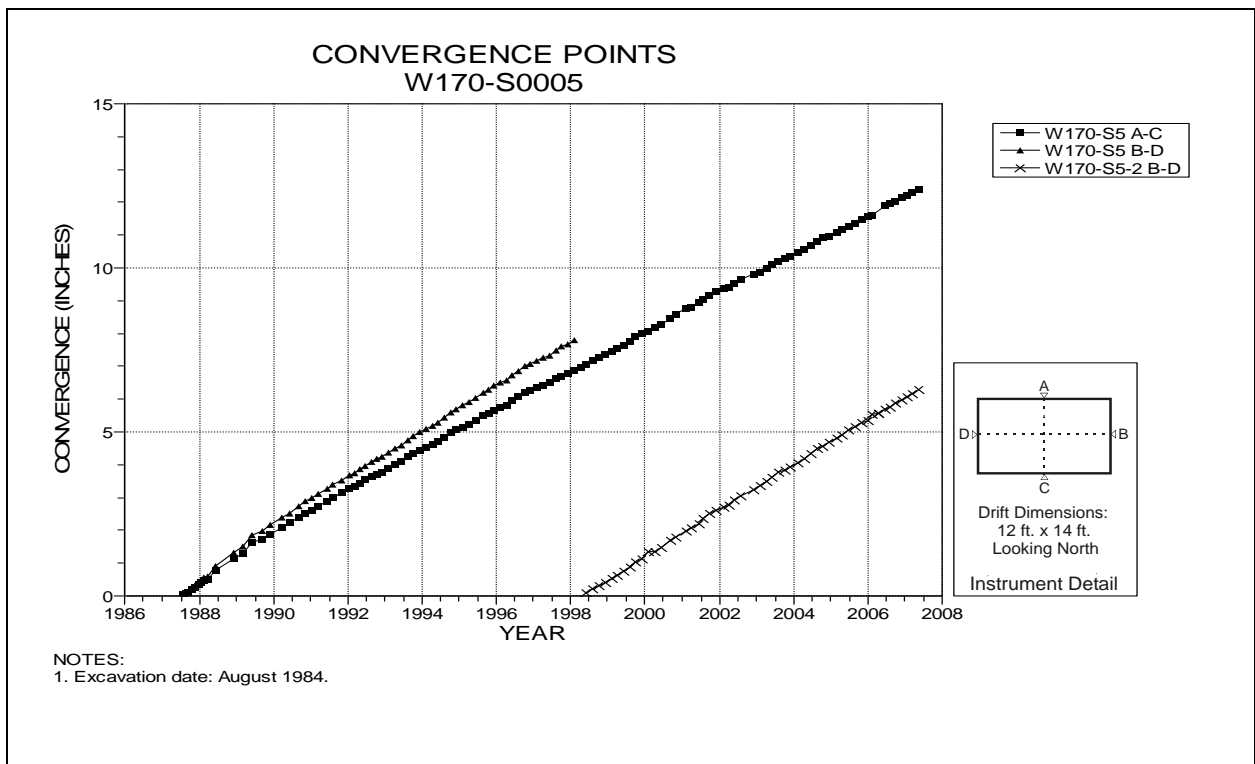


Figure 4-174 Convergence Point Array  
W170 Drift at S5 – All Chords

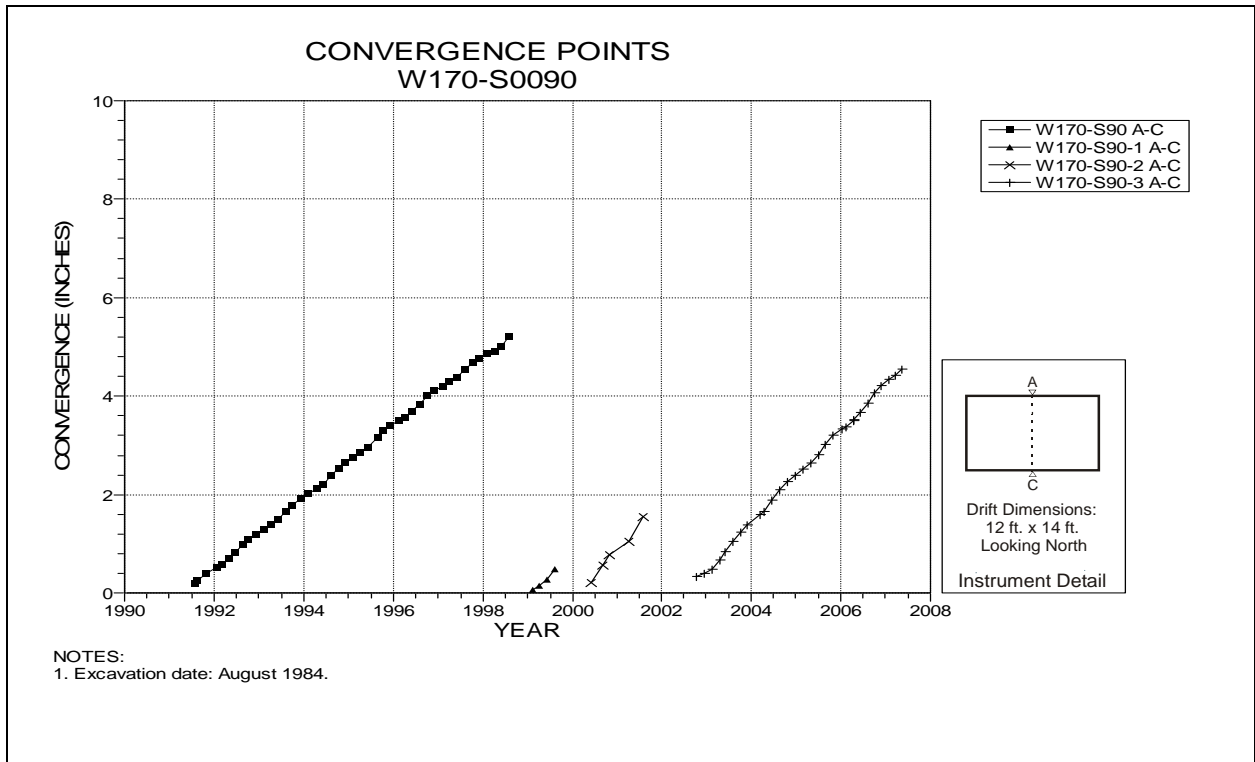


Figure 4-175 Convergence Point Array  
W170 Drift at S90 – Roof to Floor

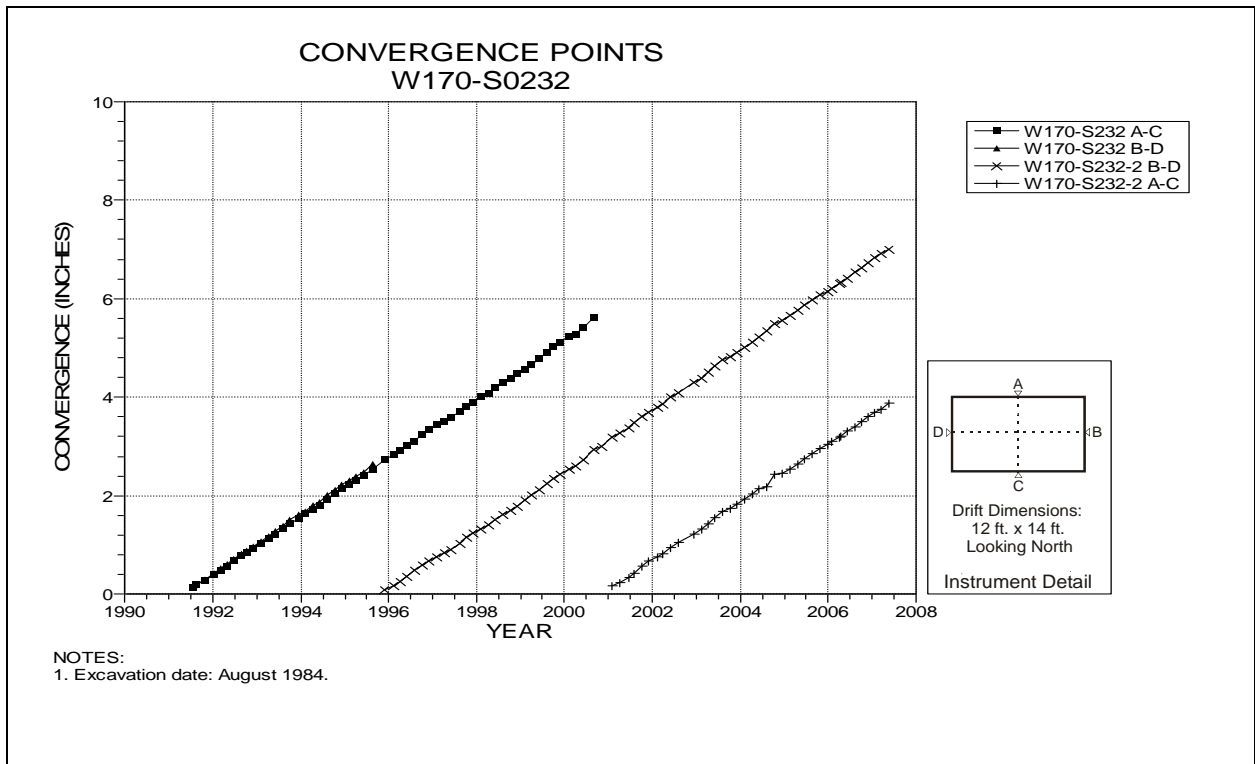


Figure 4-176 Convergence Point Array  
W170 Drift at S232 – All Chords

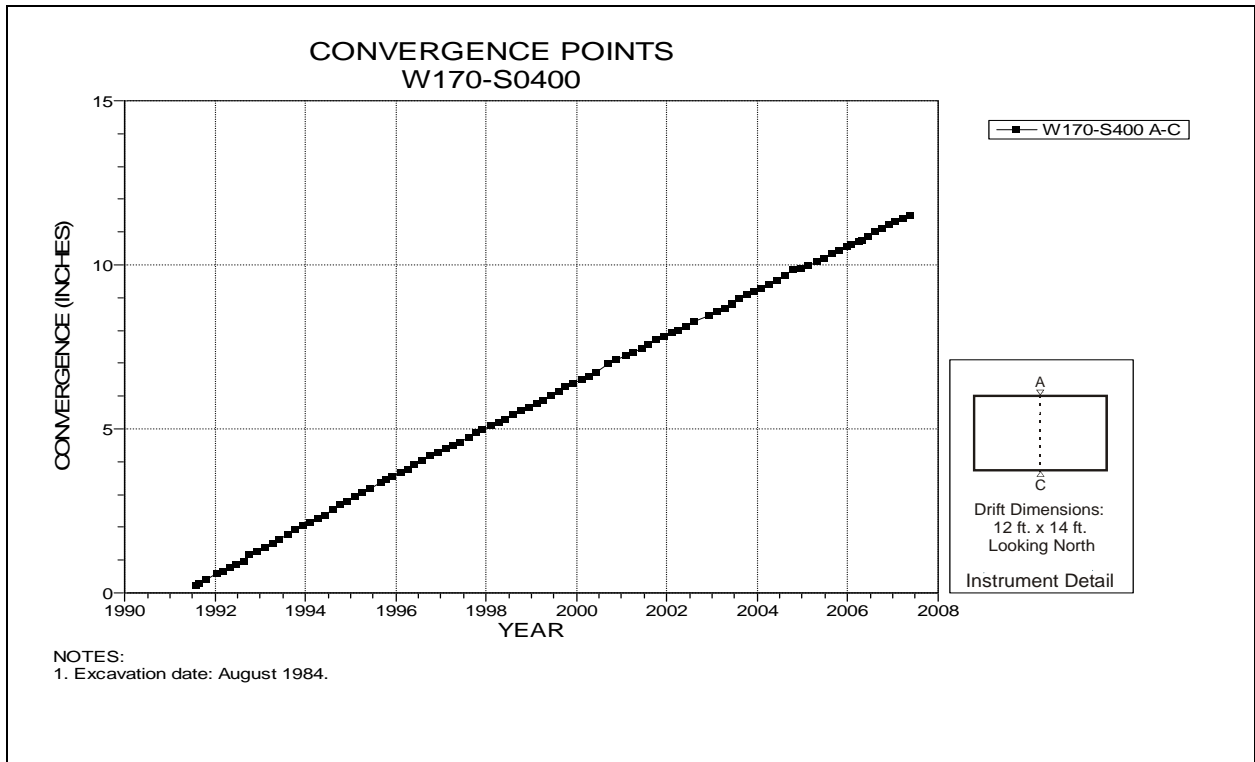


Figure 4-177 Convergence Point Array  
W170 Drift at S400 Drift Intersection – Roof to Floor

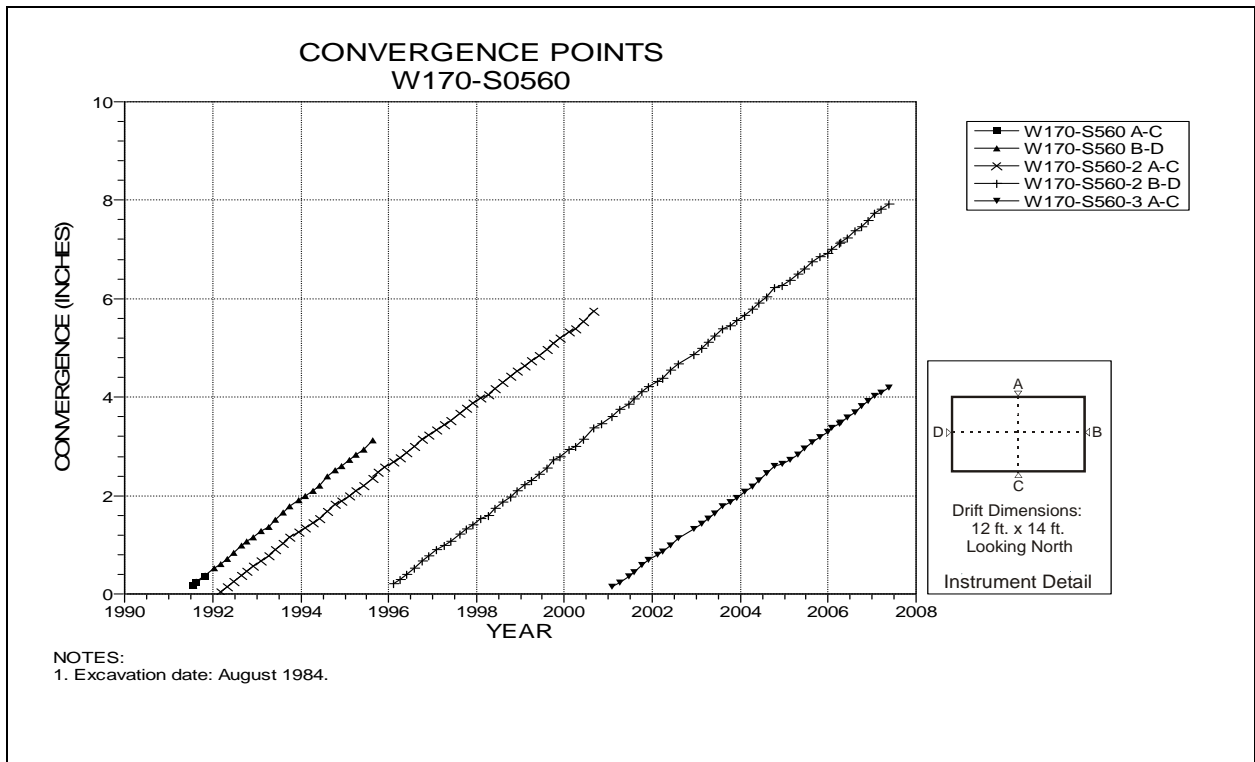


Figure 4-178 Convergence Point Array  
W170 Drift at S560 – All Chords

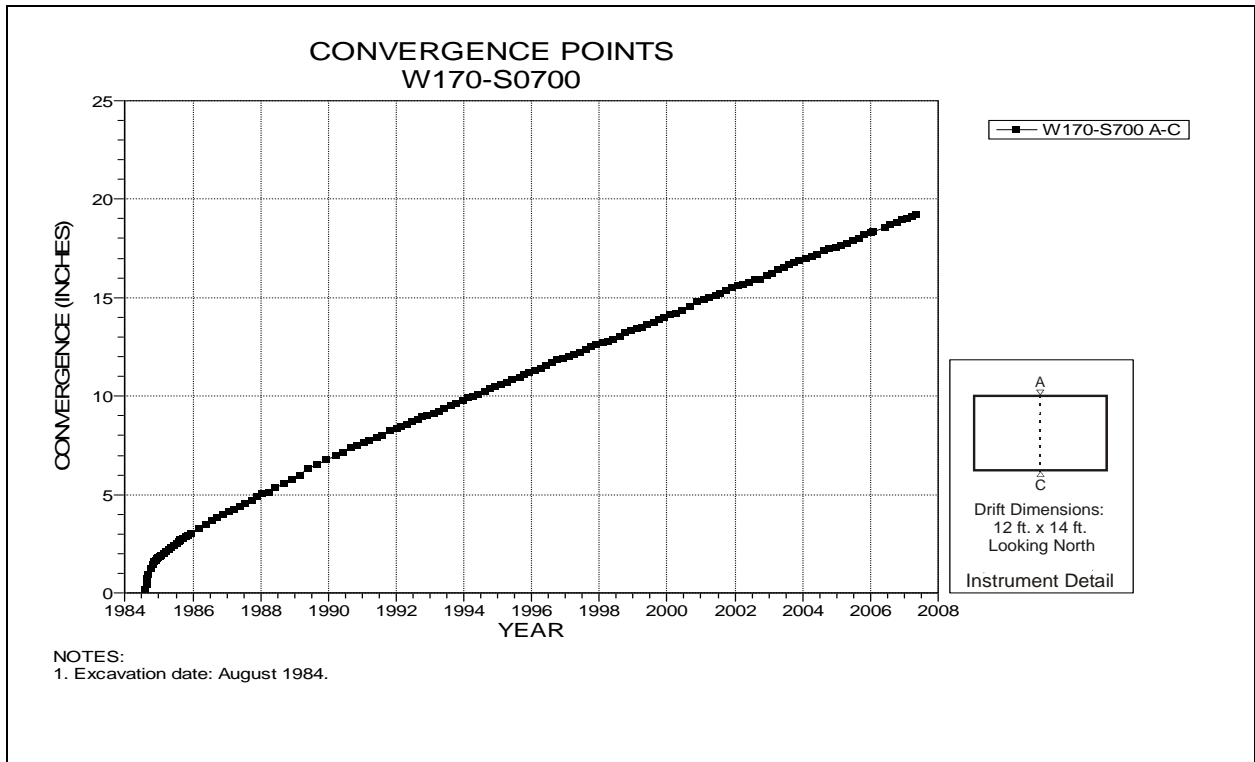


Figure 4-179 Convergence Point Array  
W170 Drift at S700 Drift Intersection – Roof to Floor

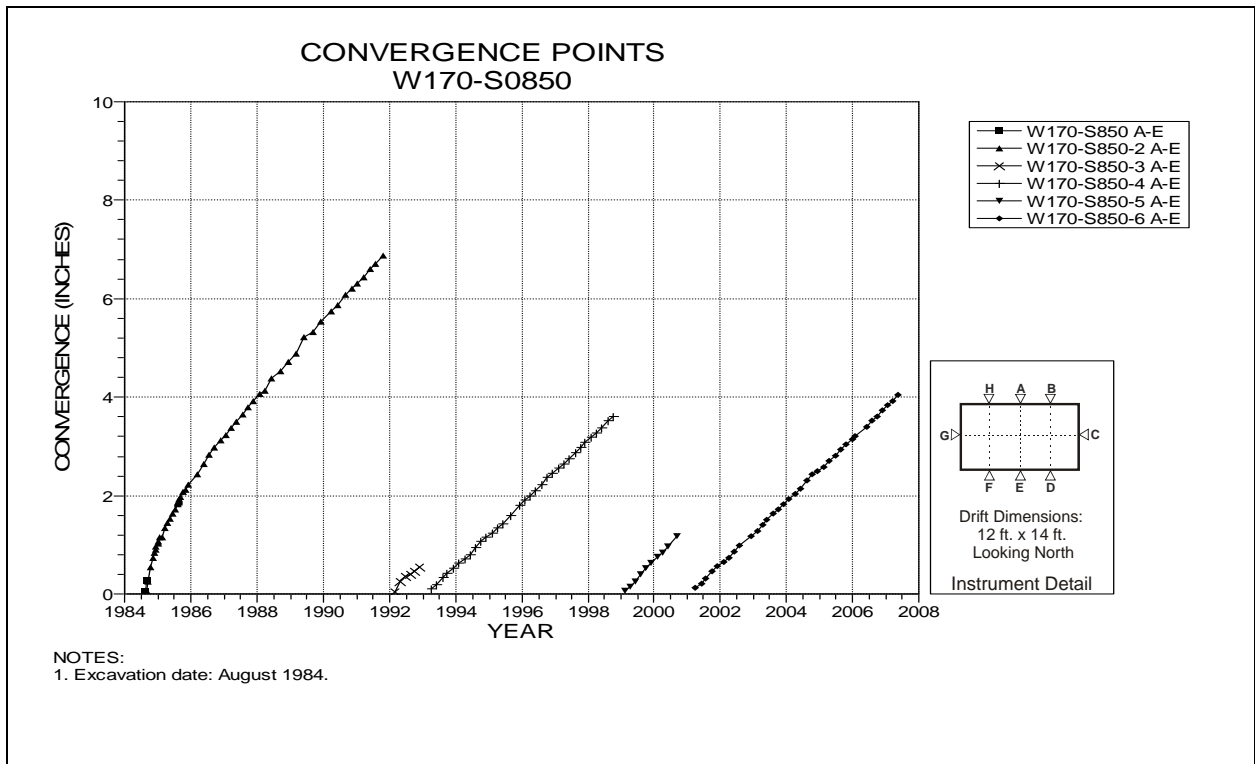


Figure 4-180 Convergence Point Array  
W170 Drift at S850 – Roof to Floor – Centerline

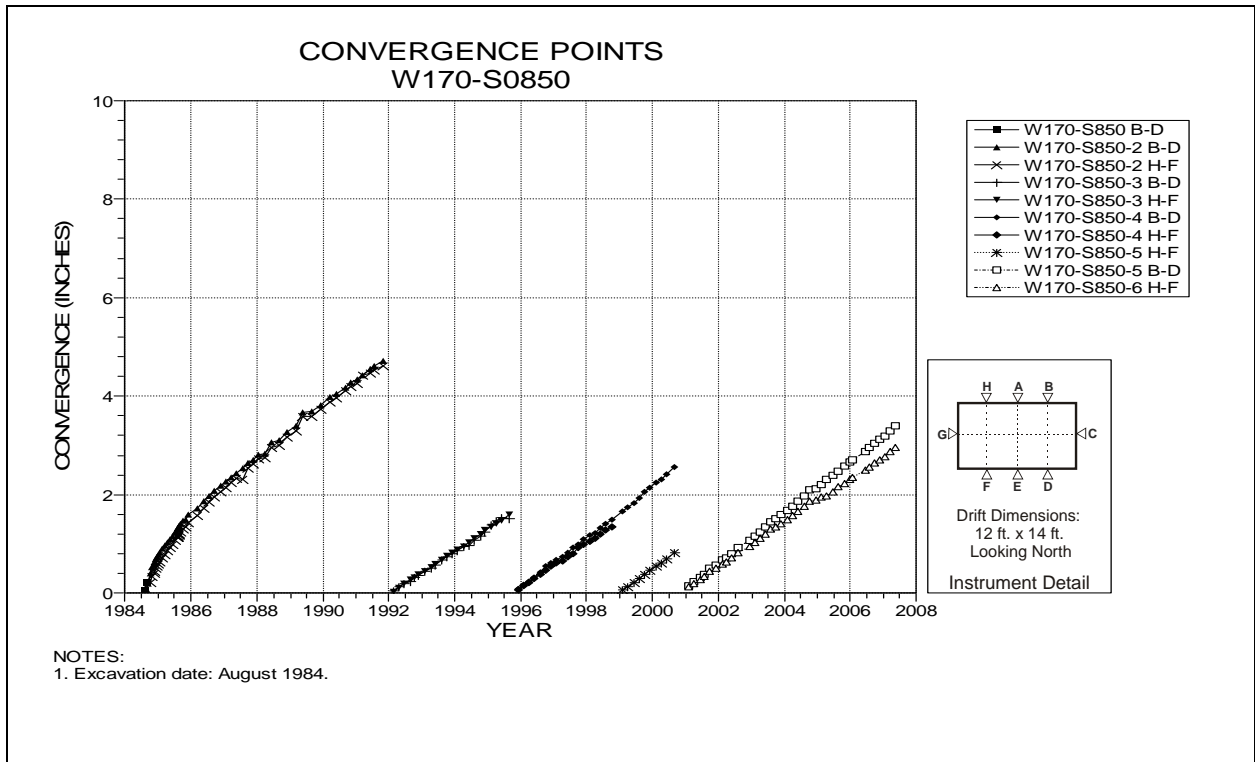


Figure 4-181 Convergence Point Array  
W170 Drift at S850 – Roof to Floor – Quarter Points

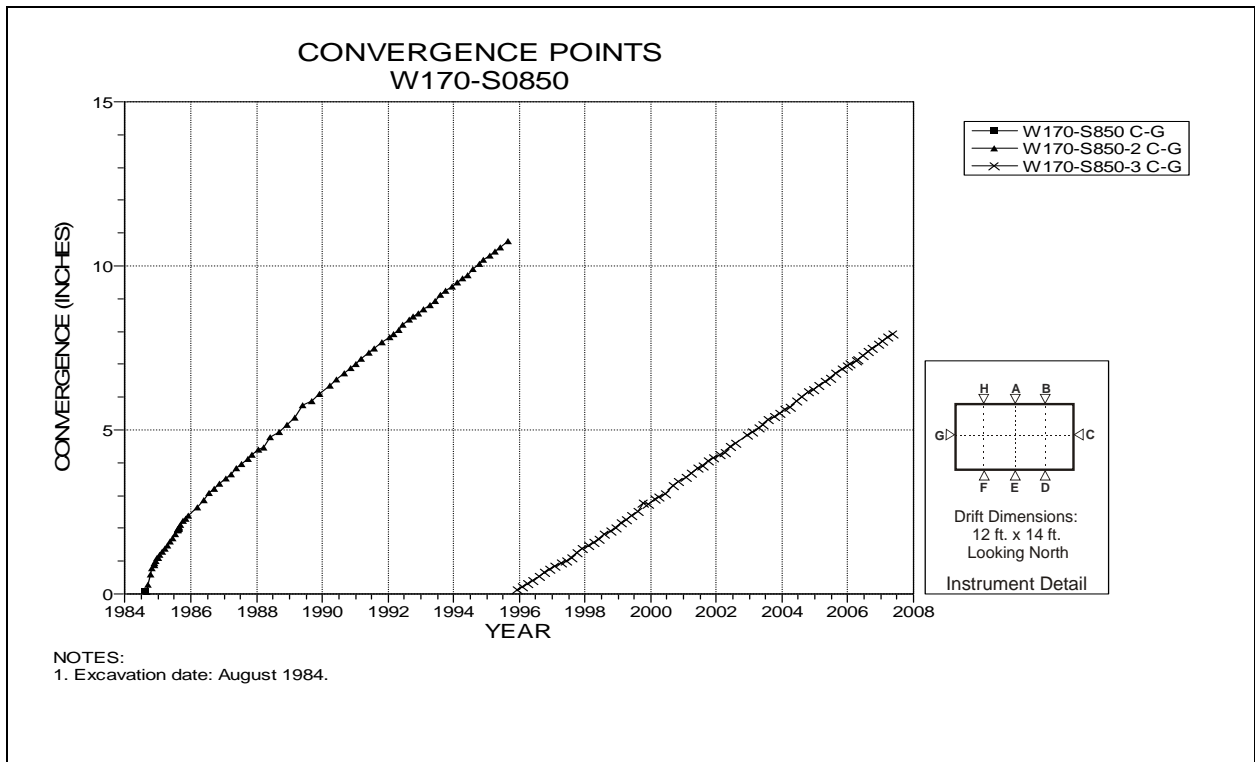


Figure 4-182 Convergence Point Array  
W170 Drift at S850 – Rib to Rib

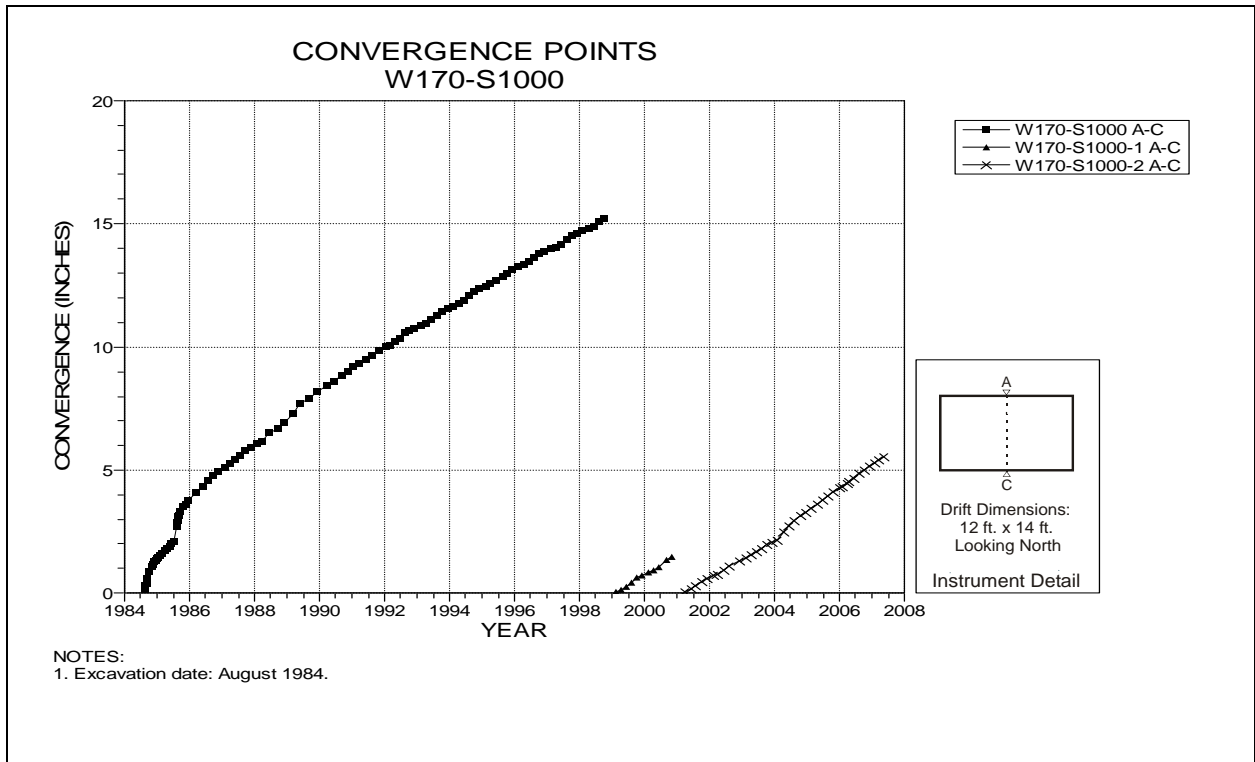


Figure 4-183 Convergence Point Array  
W170 Drift at S1000 Drift Intersection – Roof to Floor

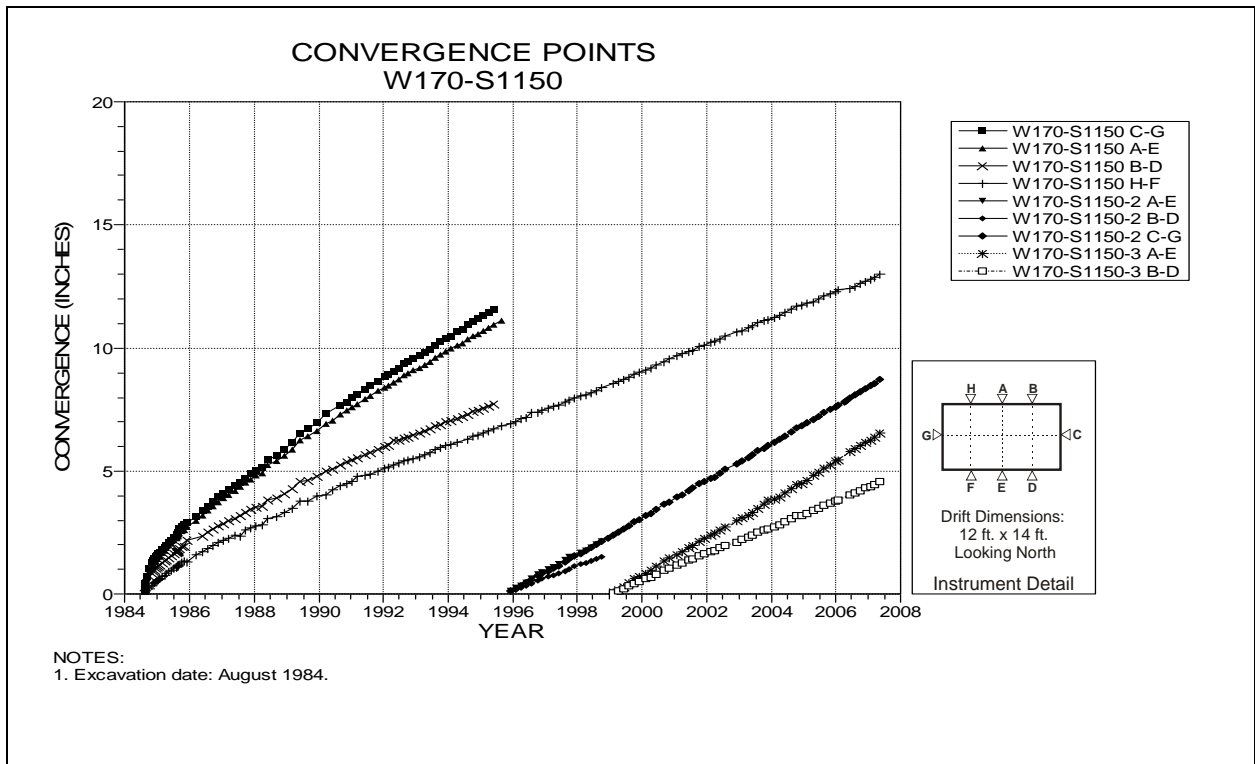


Figure 4-184 Convergence Point Array  
W170 Drift at S1150 – All Chords



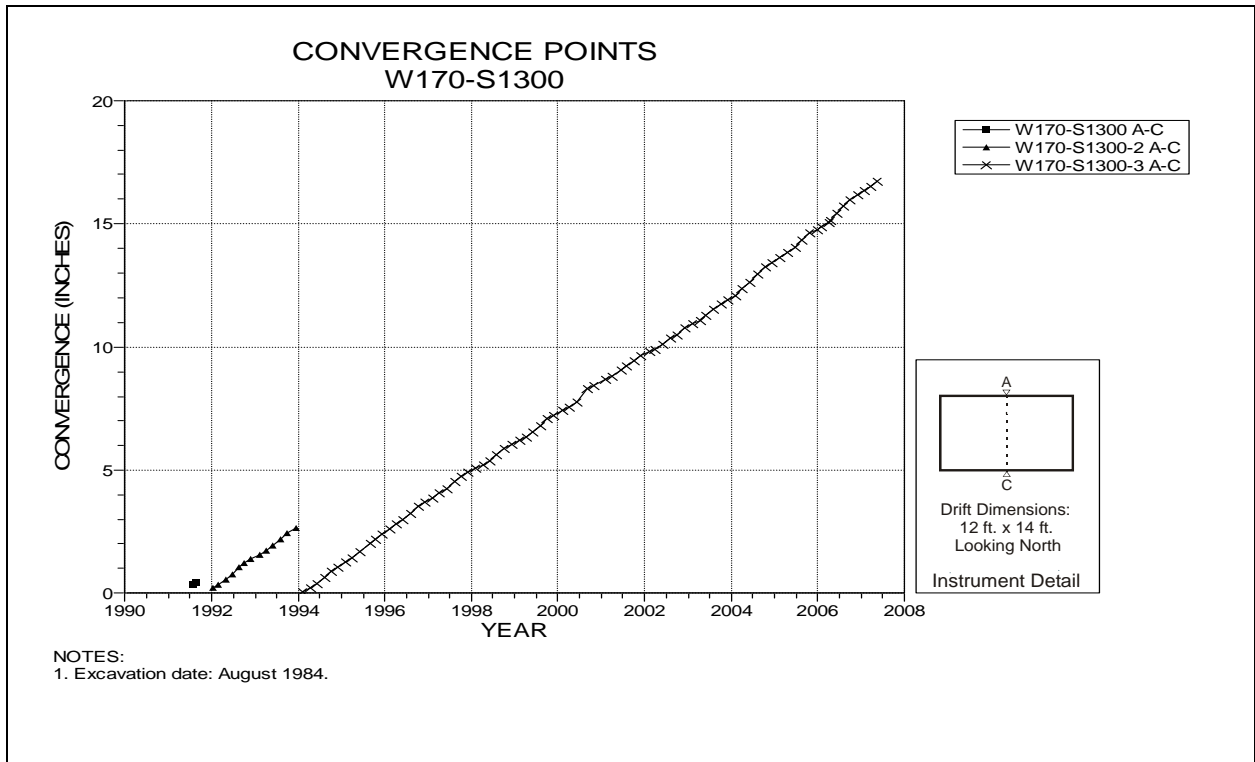


Figure 4-185 Convergence Point Array  
W170 Drift at S1300 Drift Intersection – Roof to Floor

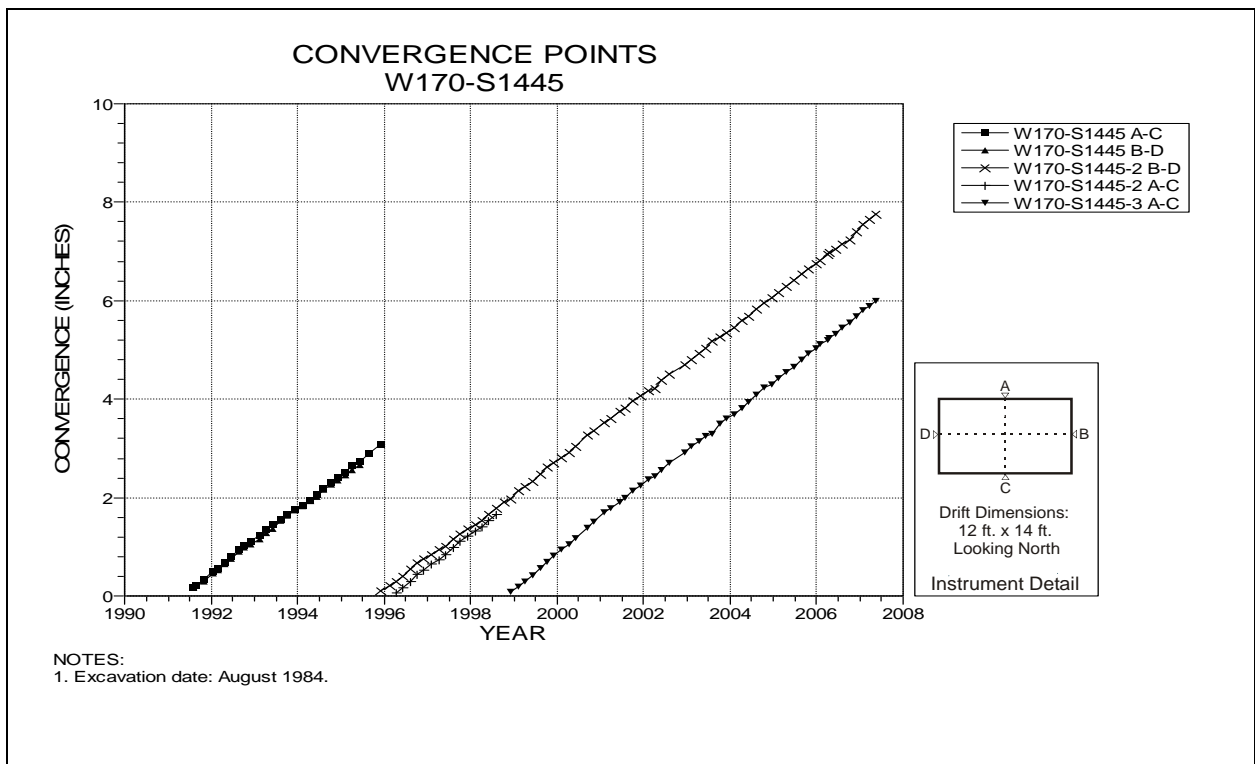


Figure 4-186 Convergence Point Array  
W170 Drift at S1445 – All Chords

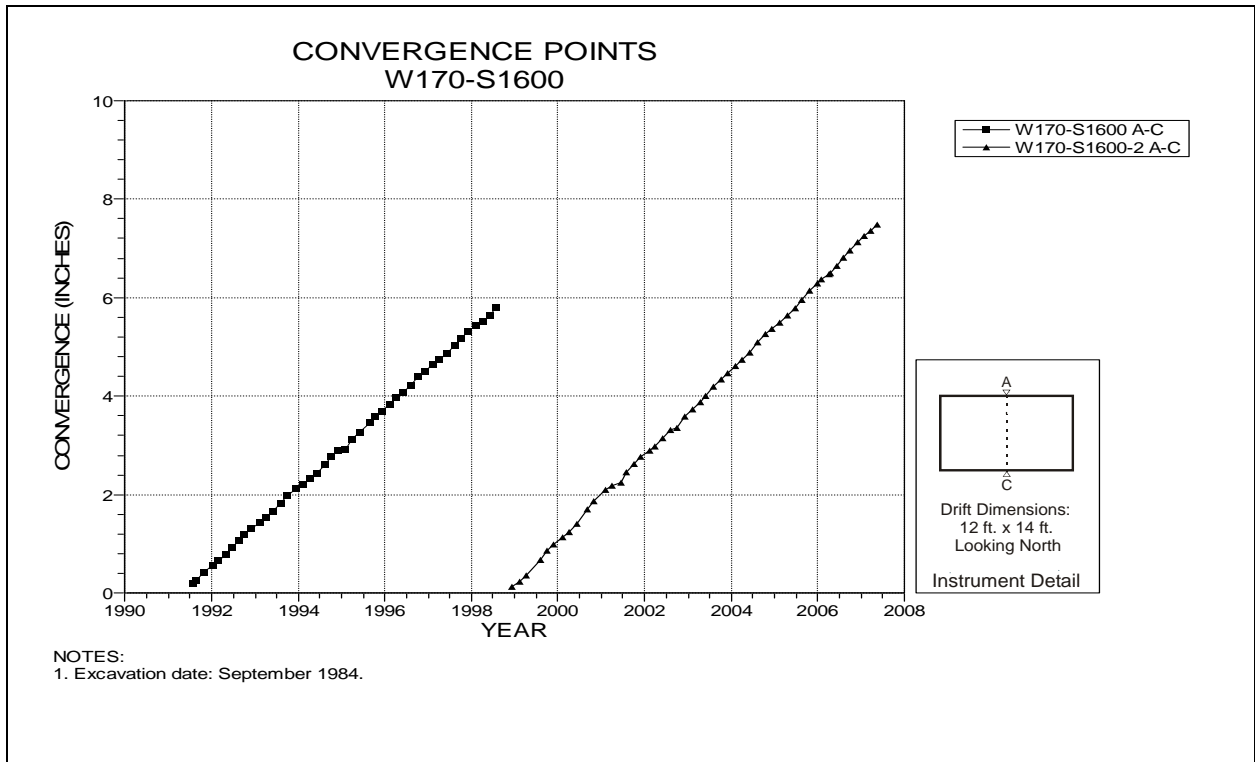


Figure 4-187 Convergence Point Array  
W170 Drift at S1600 Drift Intersection – Roof to Floor

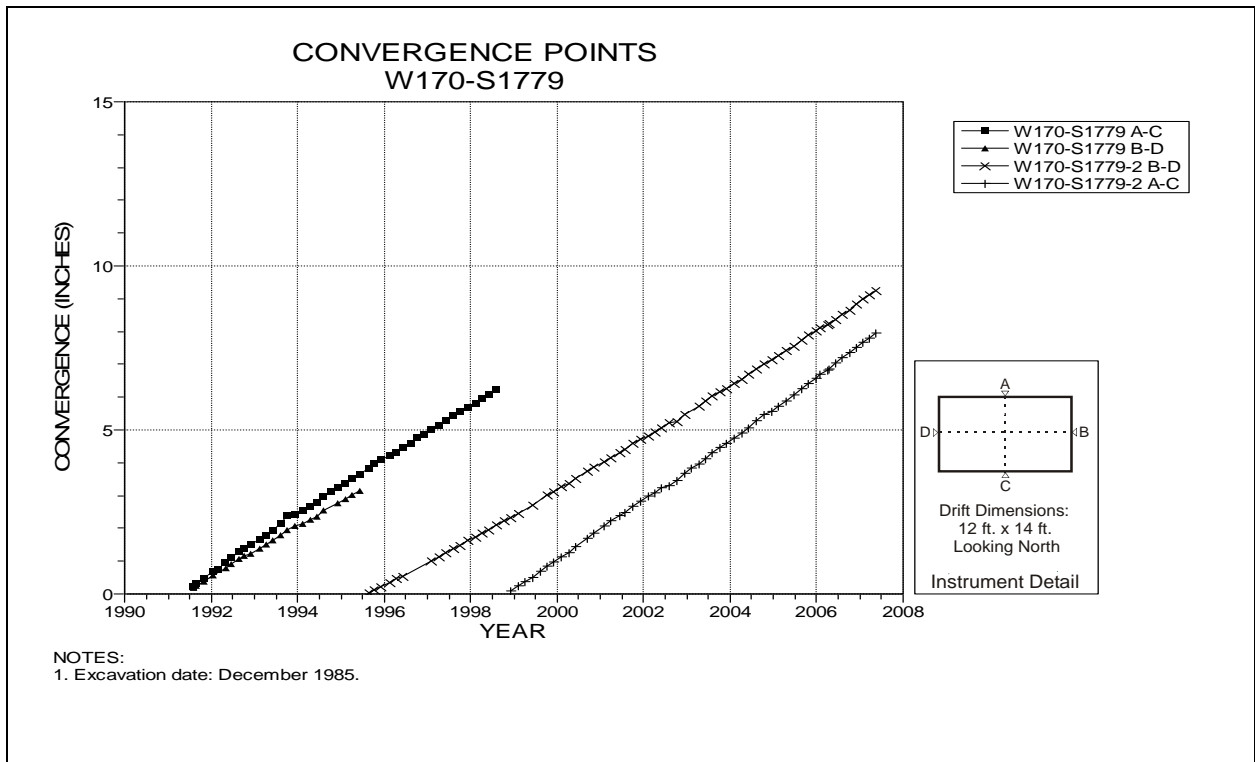


Figure 4-188 Convergence Point Array  
W170 Drift at S1779 – All Chords

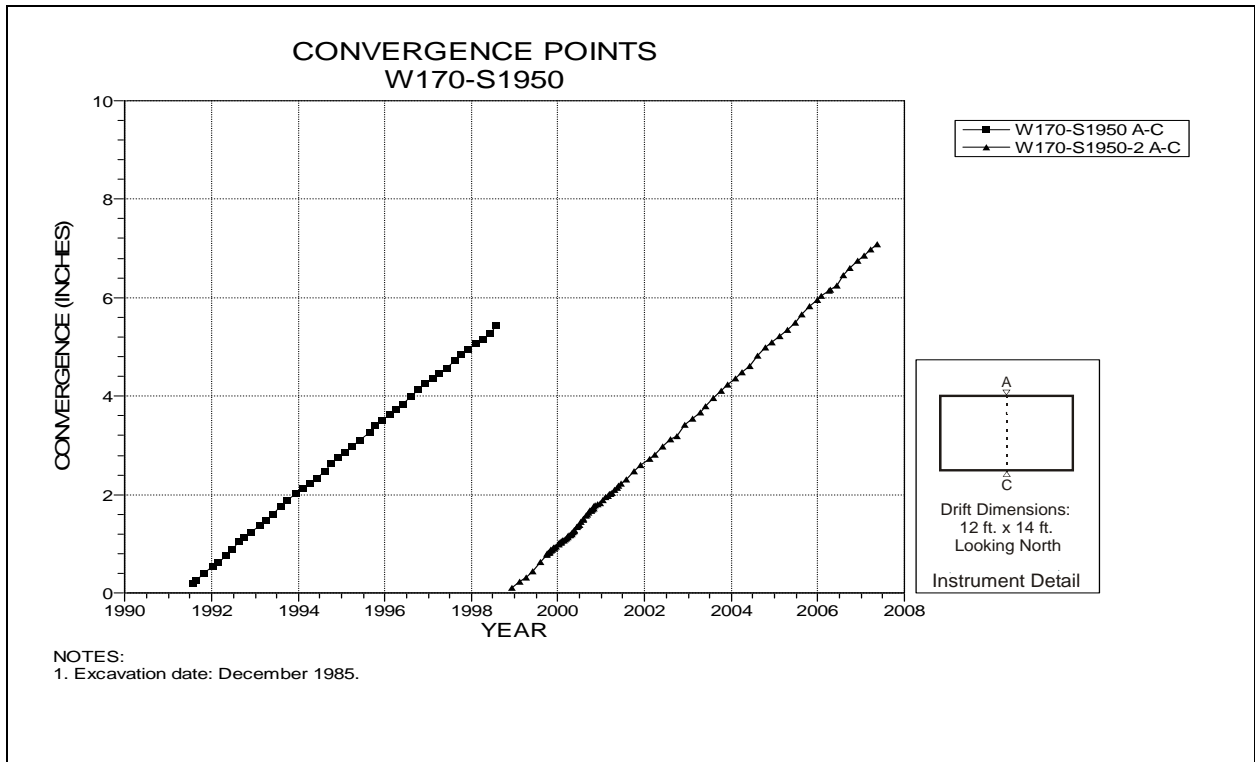


Figure 4-189 Convergence Point Array  
W170 Drift at S1950 Drift Intersection – Roof to Floor

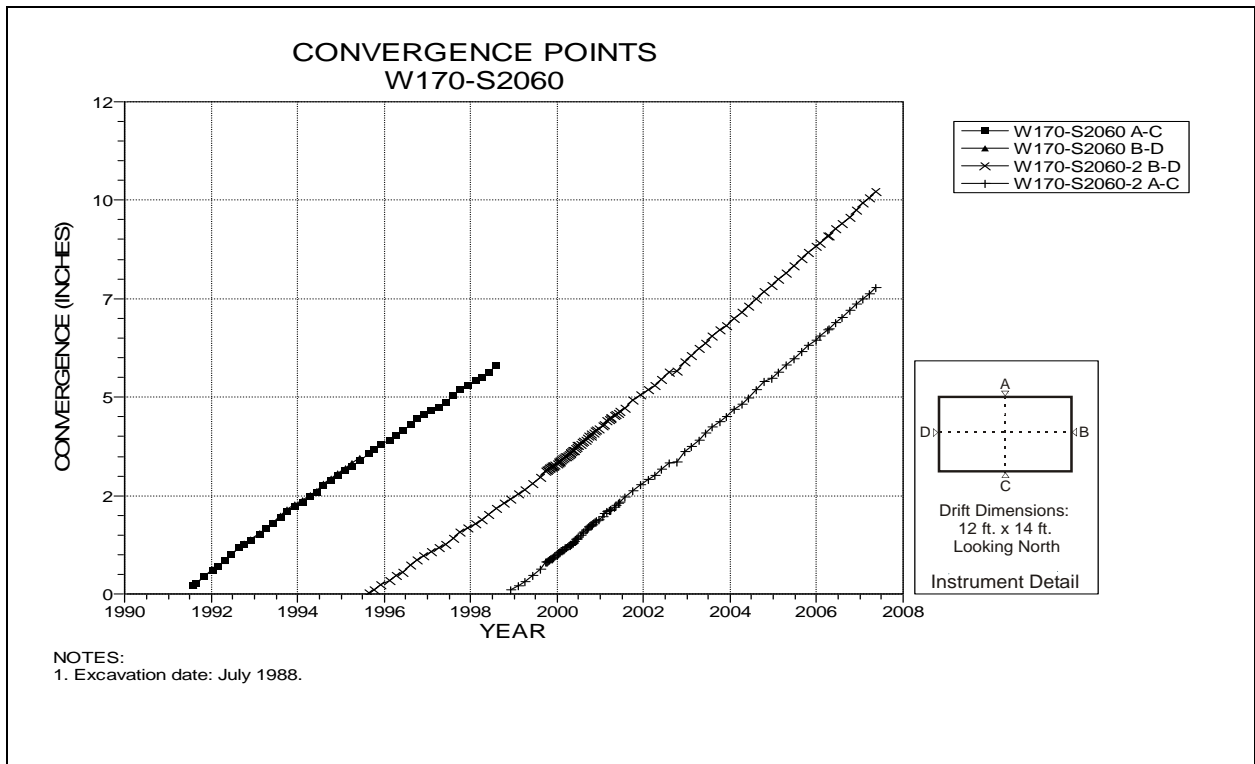


Figure 4-190 Convergence Point Array  
W170 Drift at S2060 – All Chords

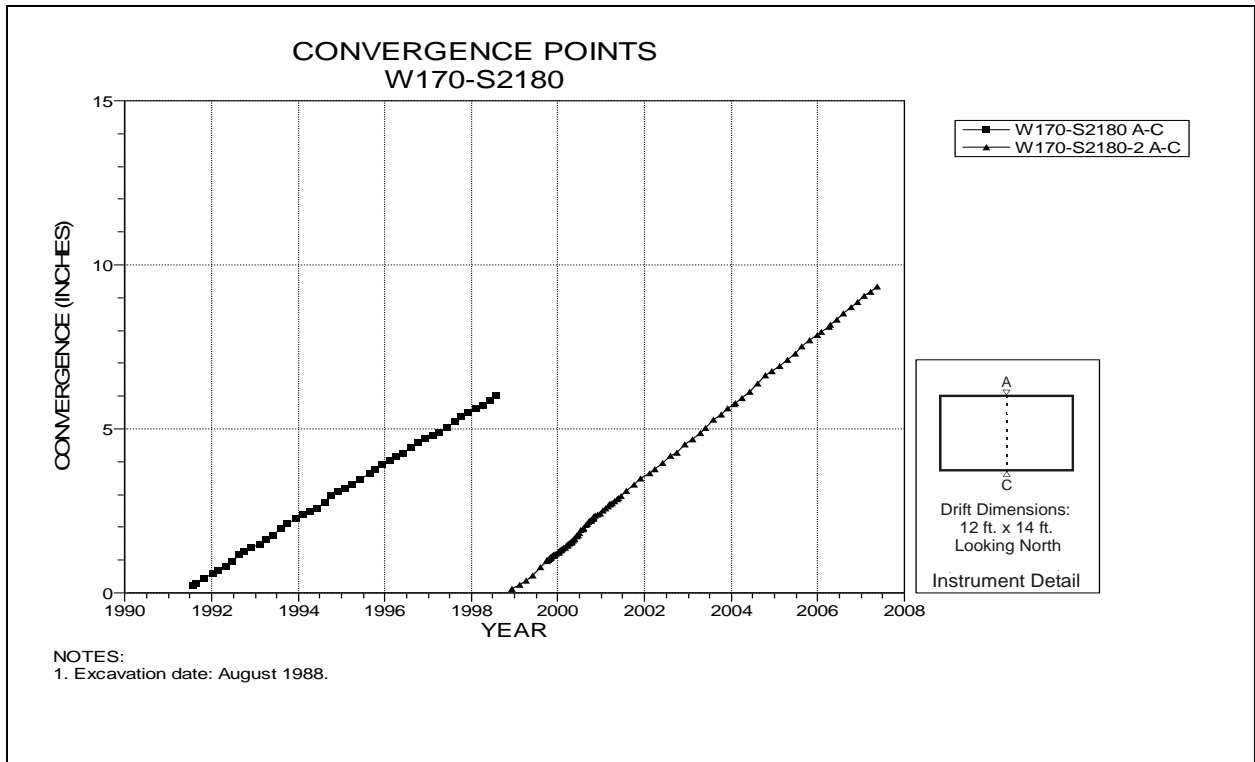


Figure 4-191 Convergence Point Array  
 W170 Drift at S2180 Drift Intersection – Roof to Floor

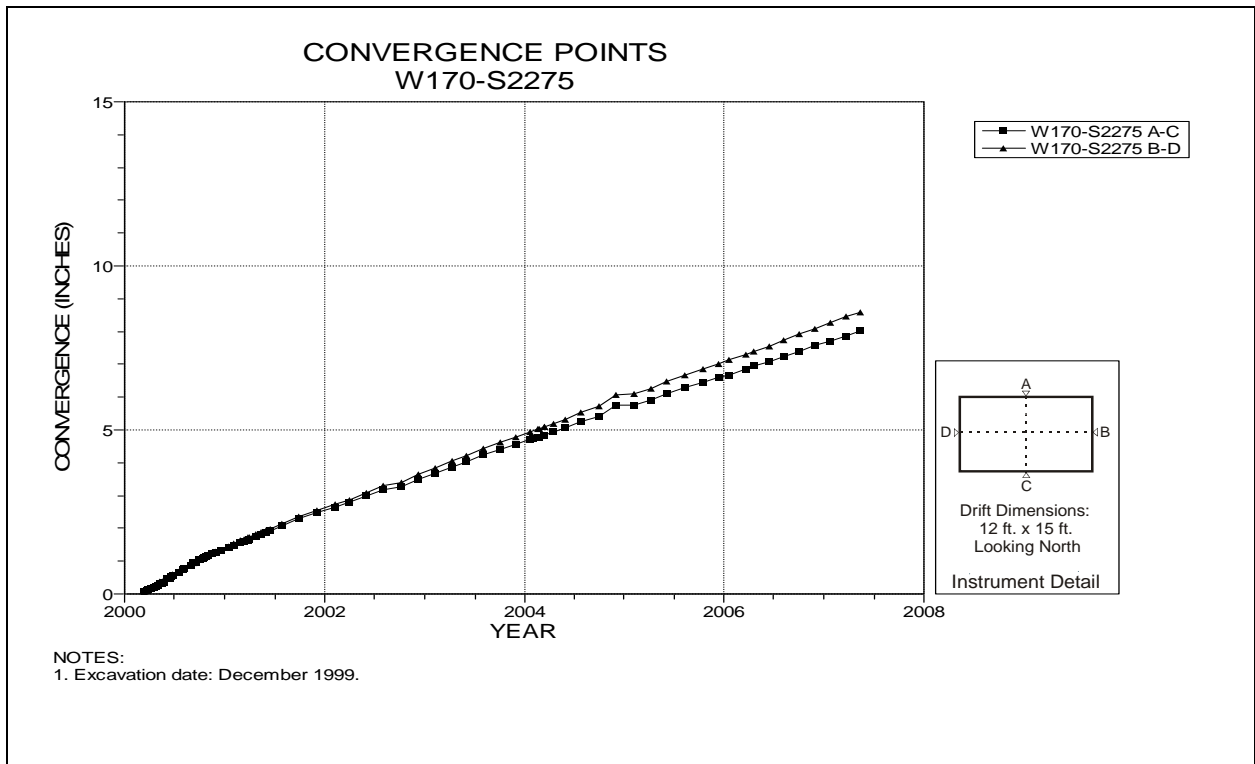


Figure 4-192 Convergence Point Array  
 W170 Drift at S2275 – All Chords

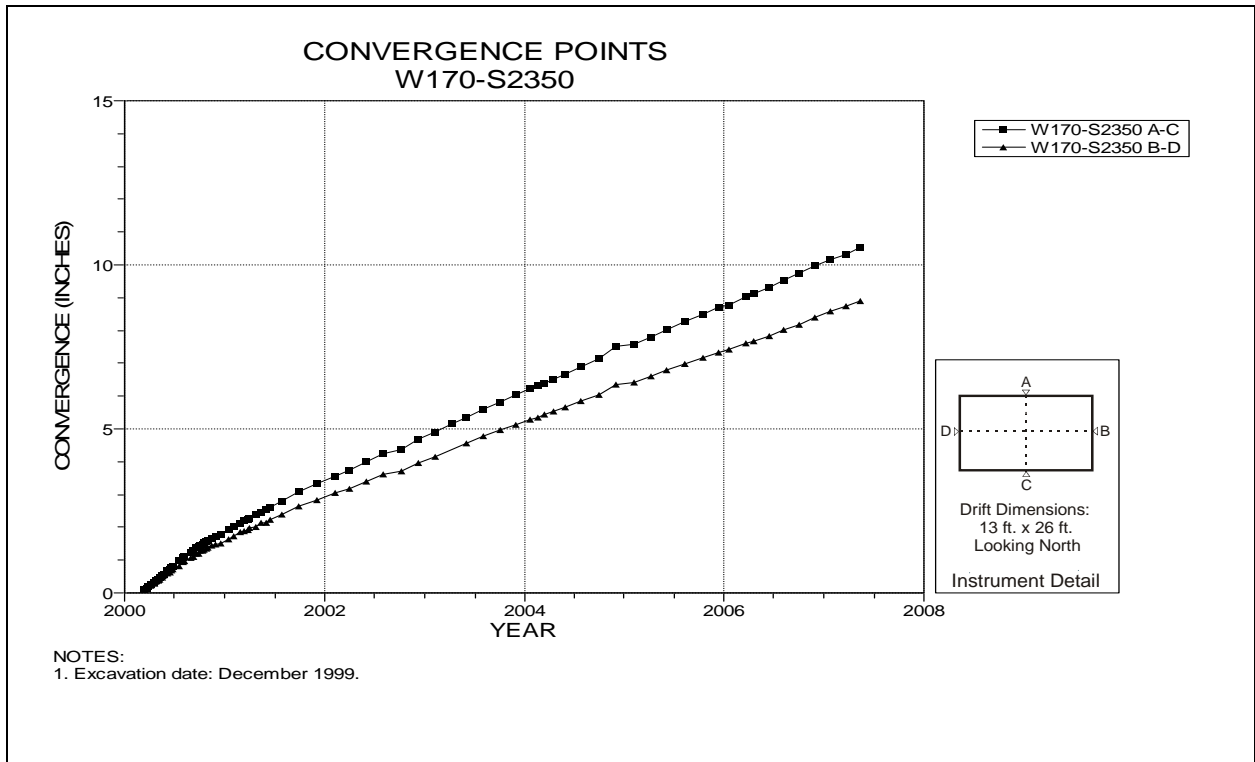


Figure 4-193 Convergence Point Array  
 W170 Drift at S2350 – All Chords

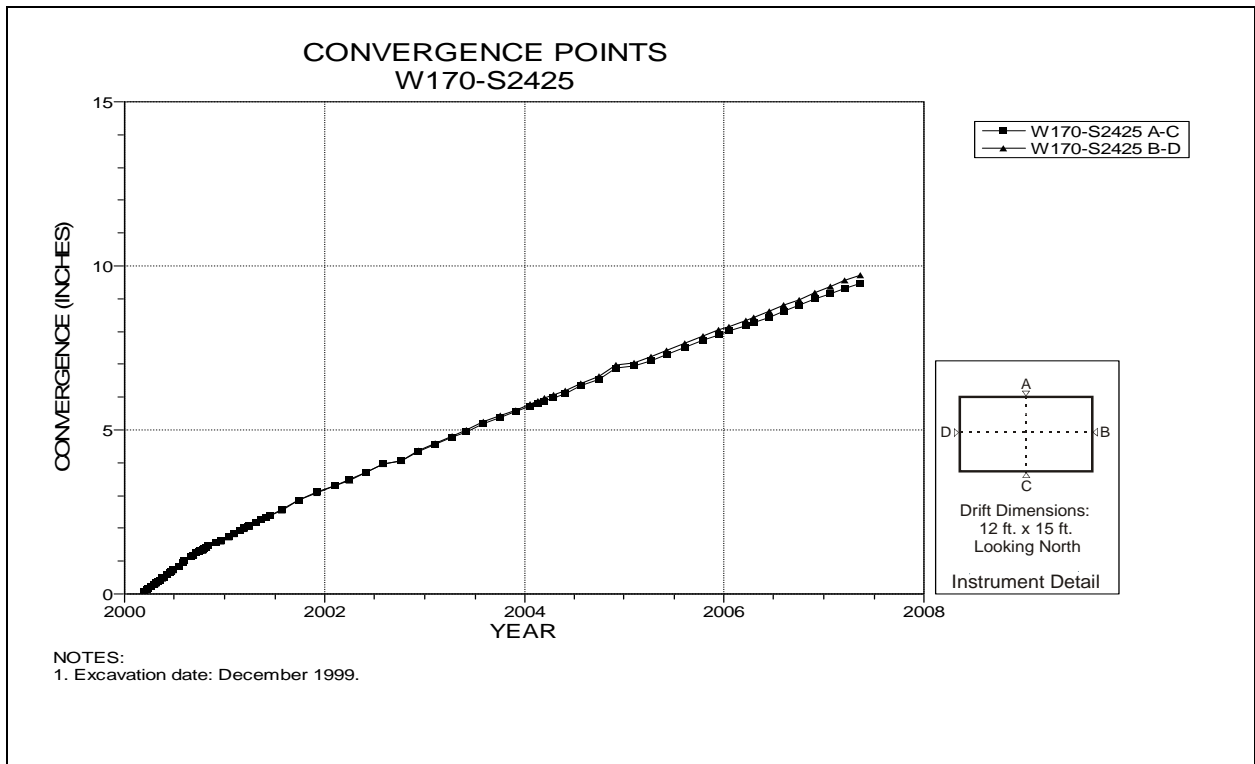


Figure 4-194 Convergence Point Array  
 W170 Drift at S2425 – All Chords

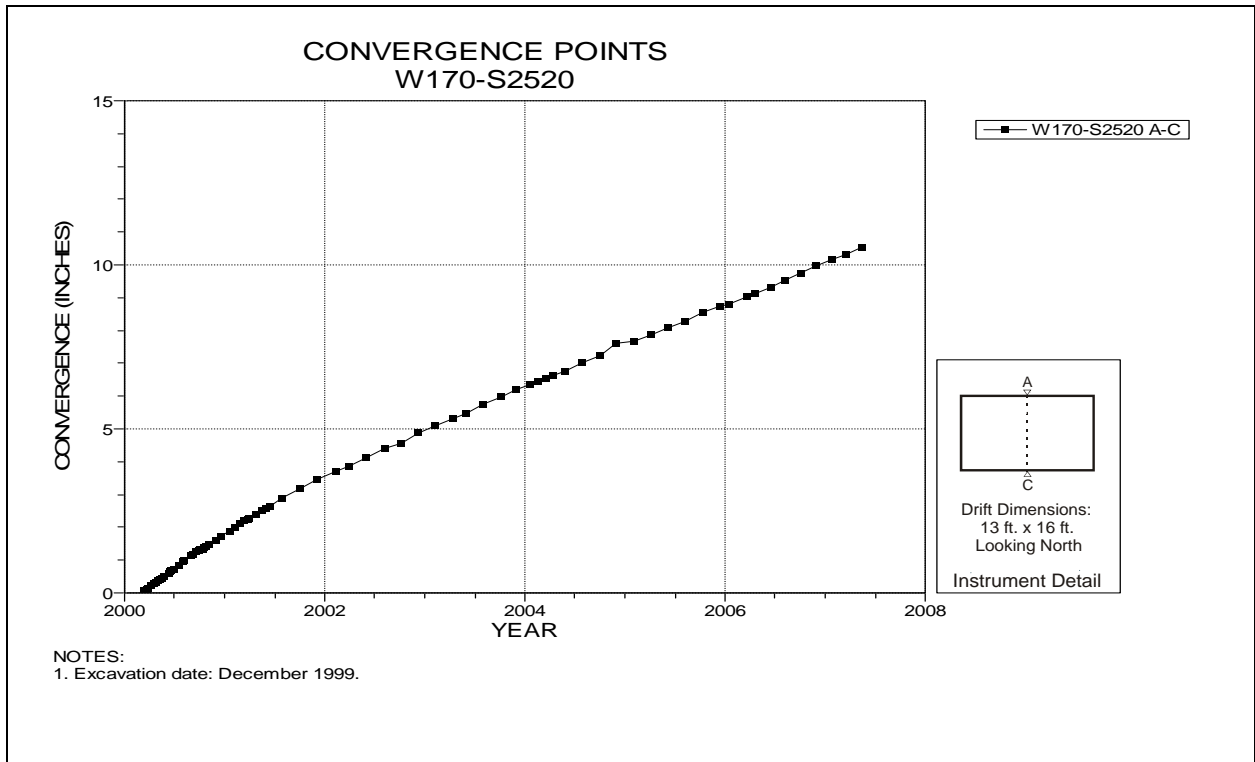


Figure 4-195 Convergence Point Array  
W170 Drift at S2520 Drift Intersection – Roof to Floor

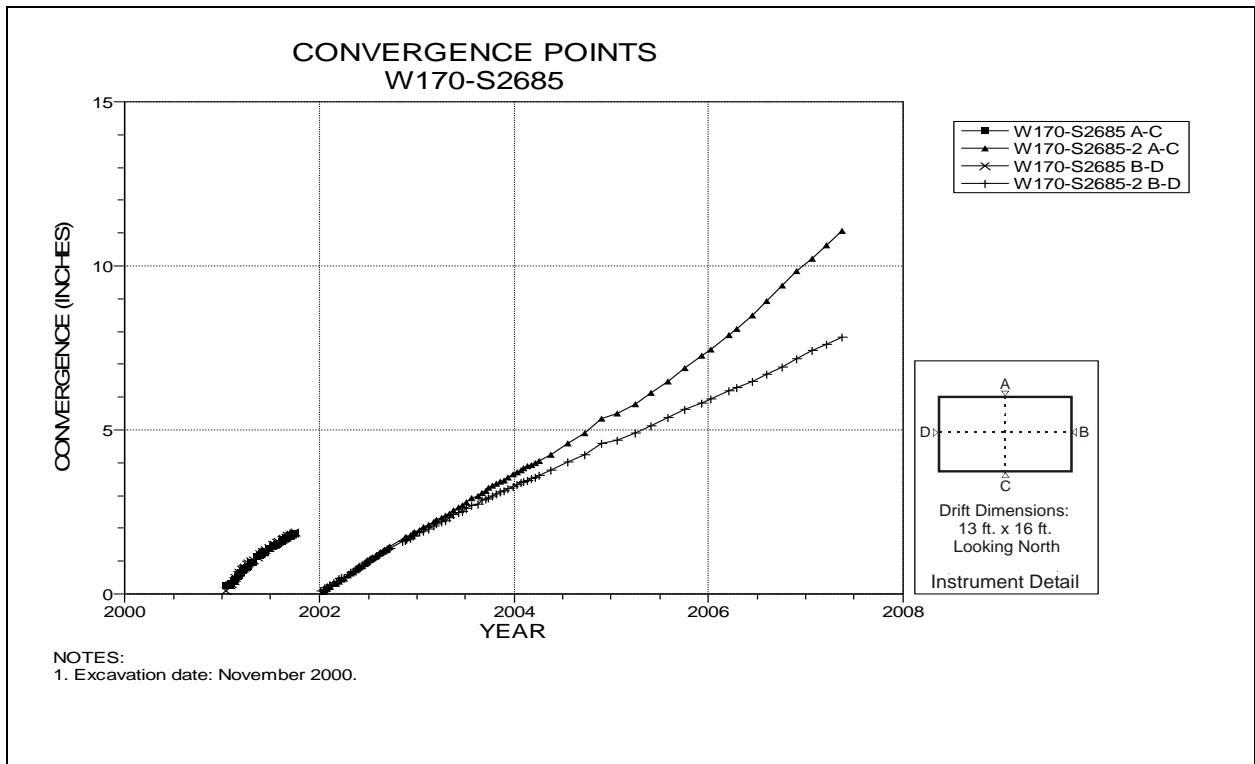


Figure 4-196 Convergence Point Array  
W170 Drift at S2685 – All Chords

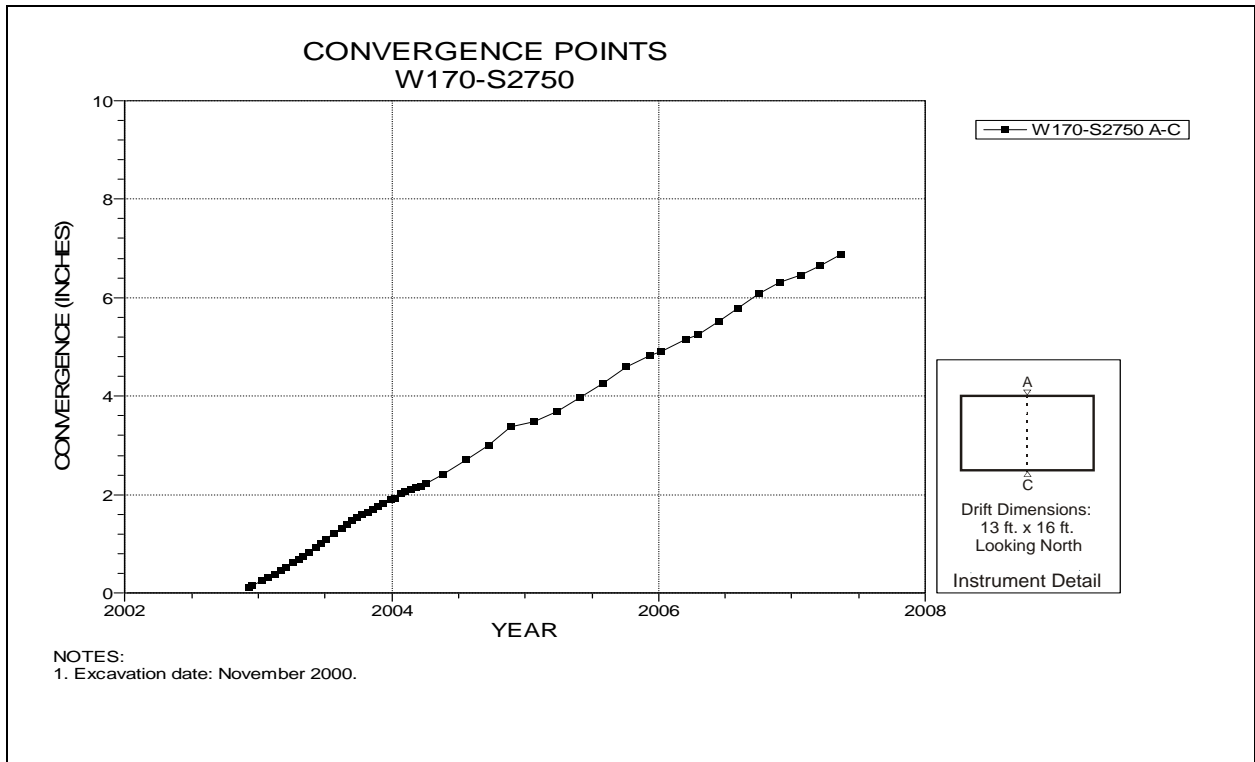


Figure 4-197 Convergence Point Array  
W170 Drift at S2750 Drift Intersection – Roof to Floor

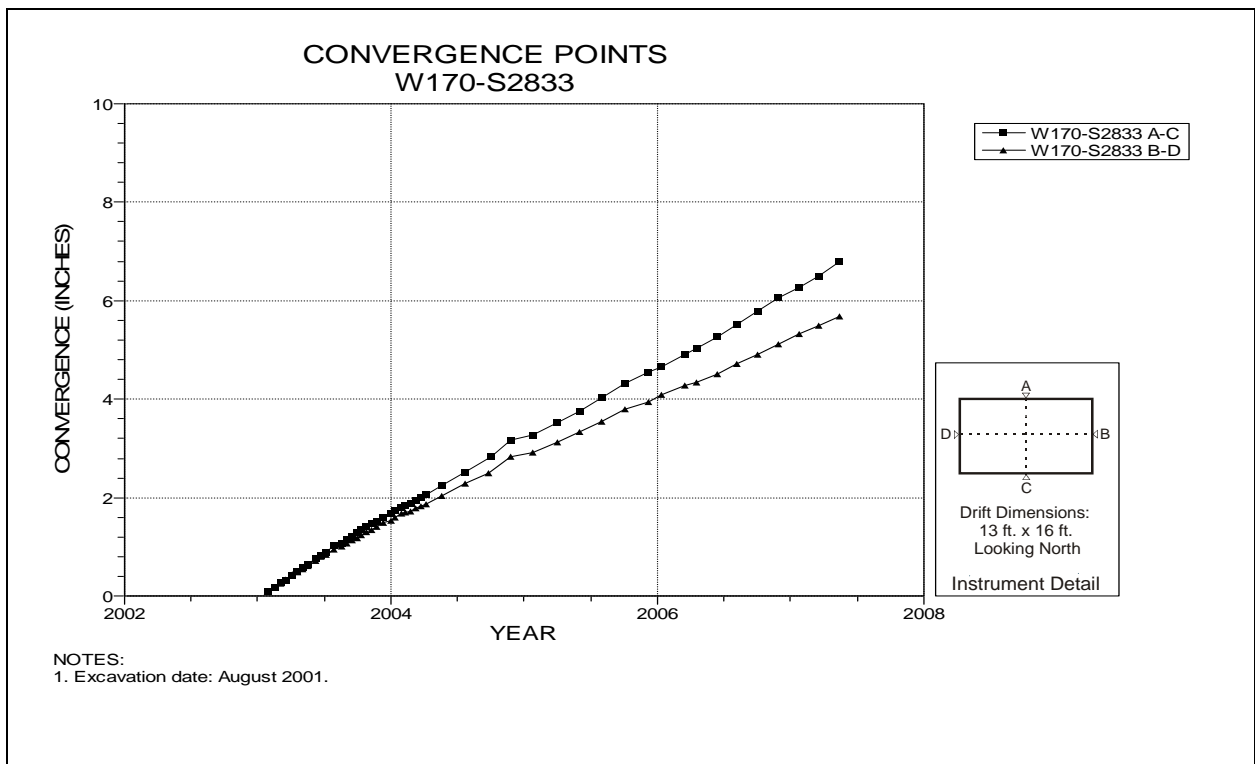


Figure 4-198 Convergence Point Array  
W170 Drift at S2833 – All Chords

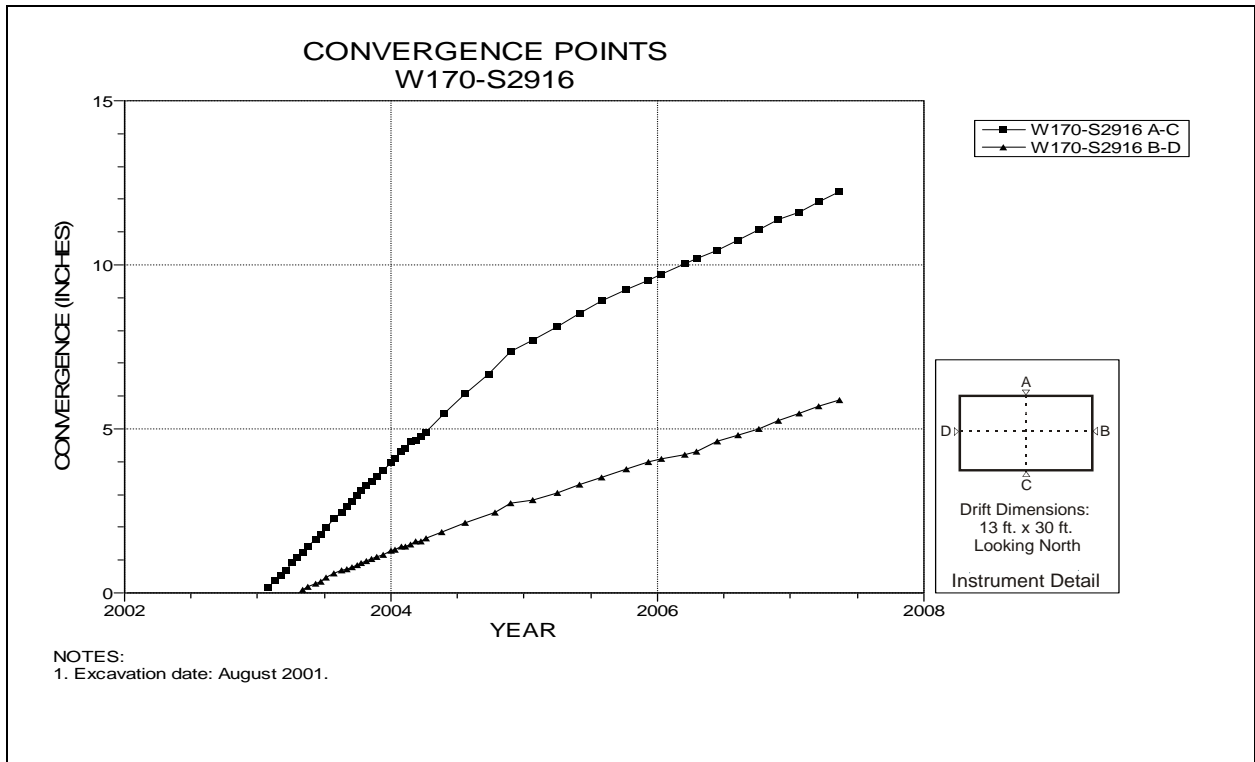


Figure 4-199 Convergence Point Array  
W170 Drift at S2916 – All Chords

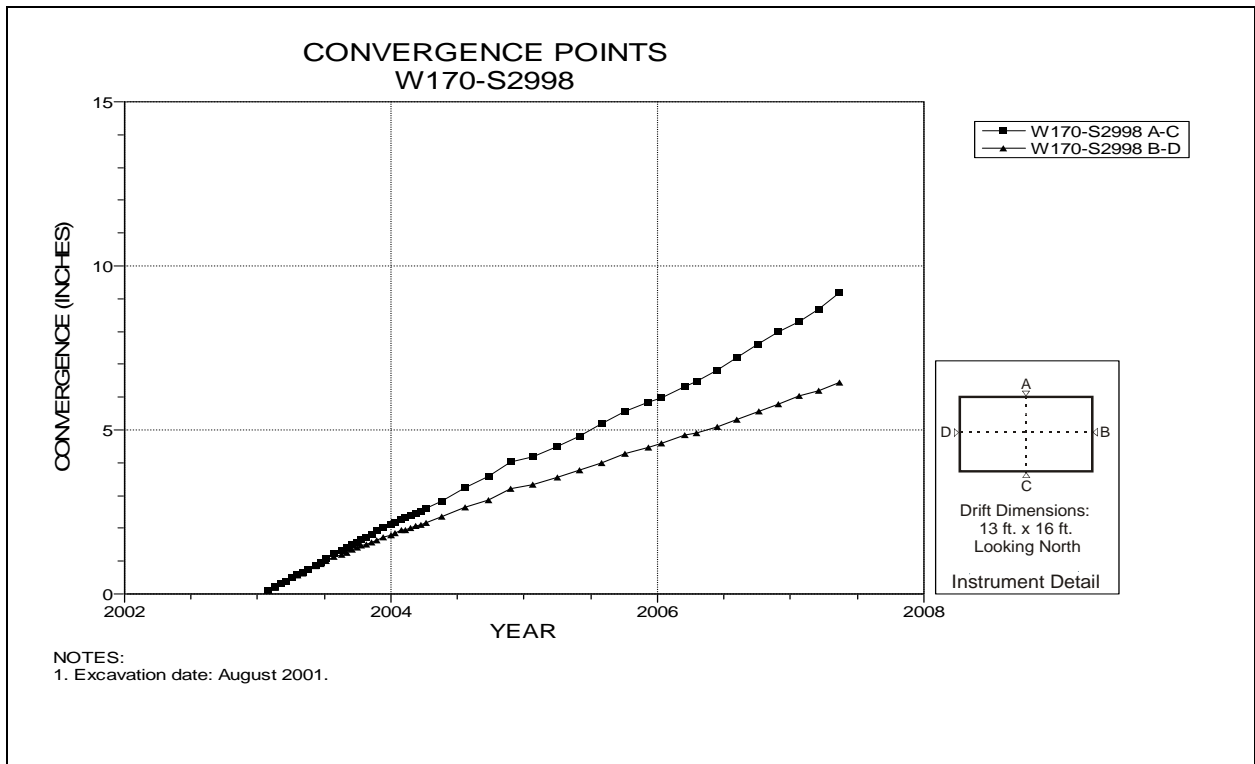


Figure 4-200 Convergence Point Array  
W170 Drift at S2998 – All Chords



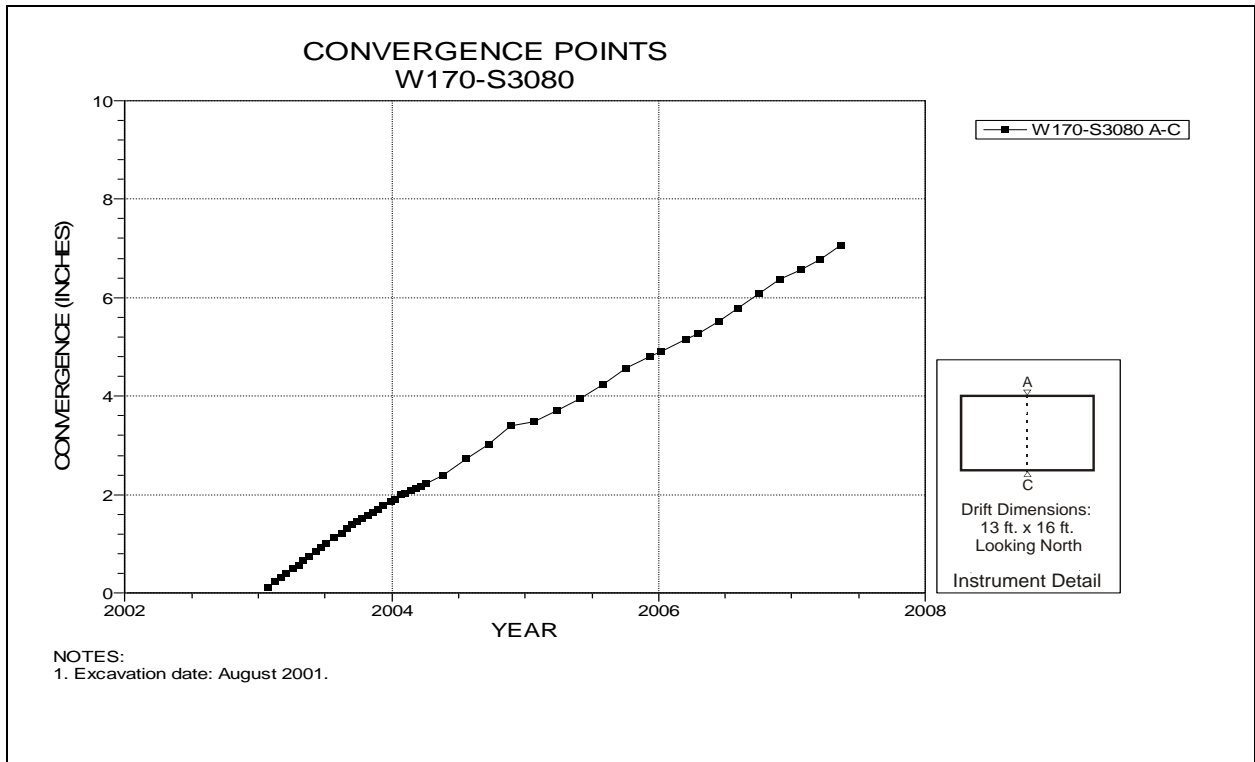


Figure 4-201 Convergence Point Array  
W170 Drift at S3080 Drift Intersection – Roof to Floor

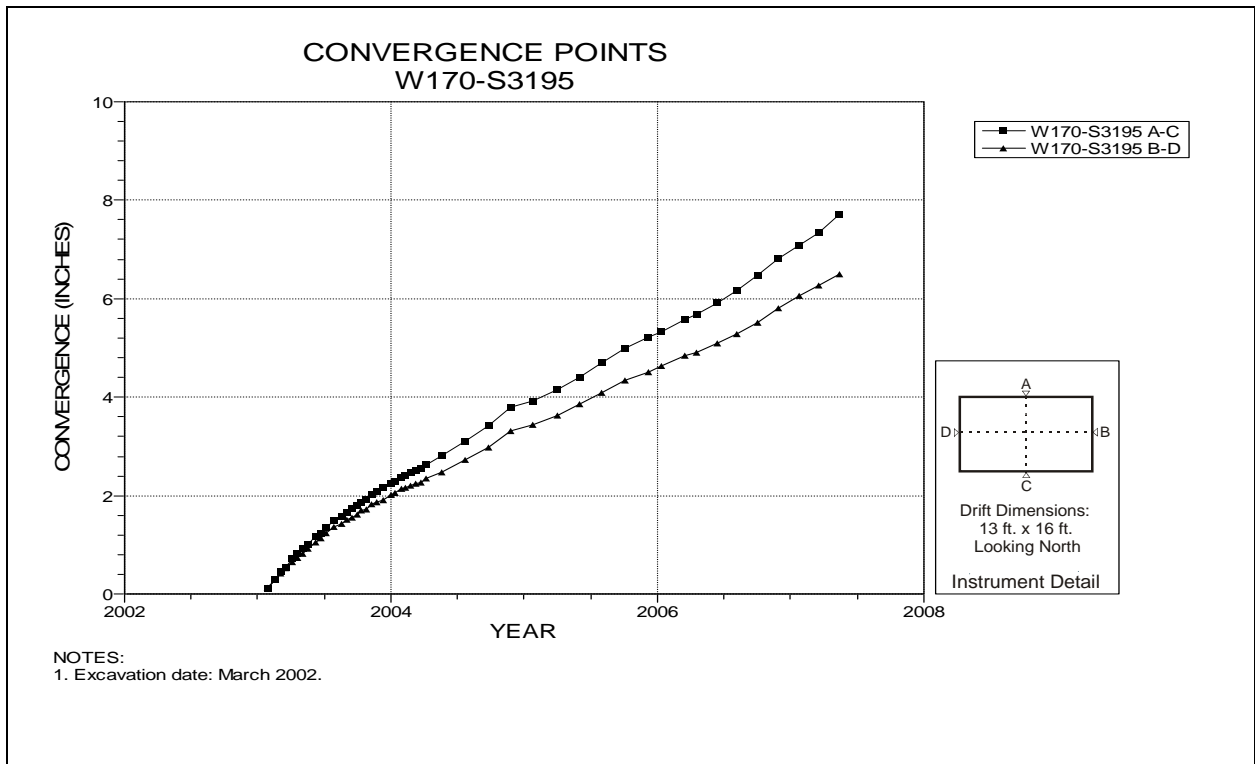


Figure 4-202 Convergence Point Array  
W170 Drift at S3195 – All Chords

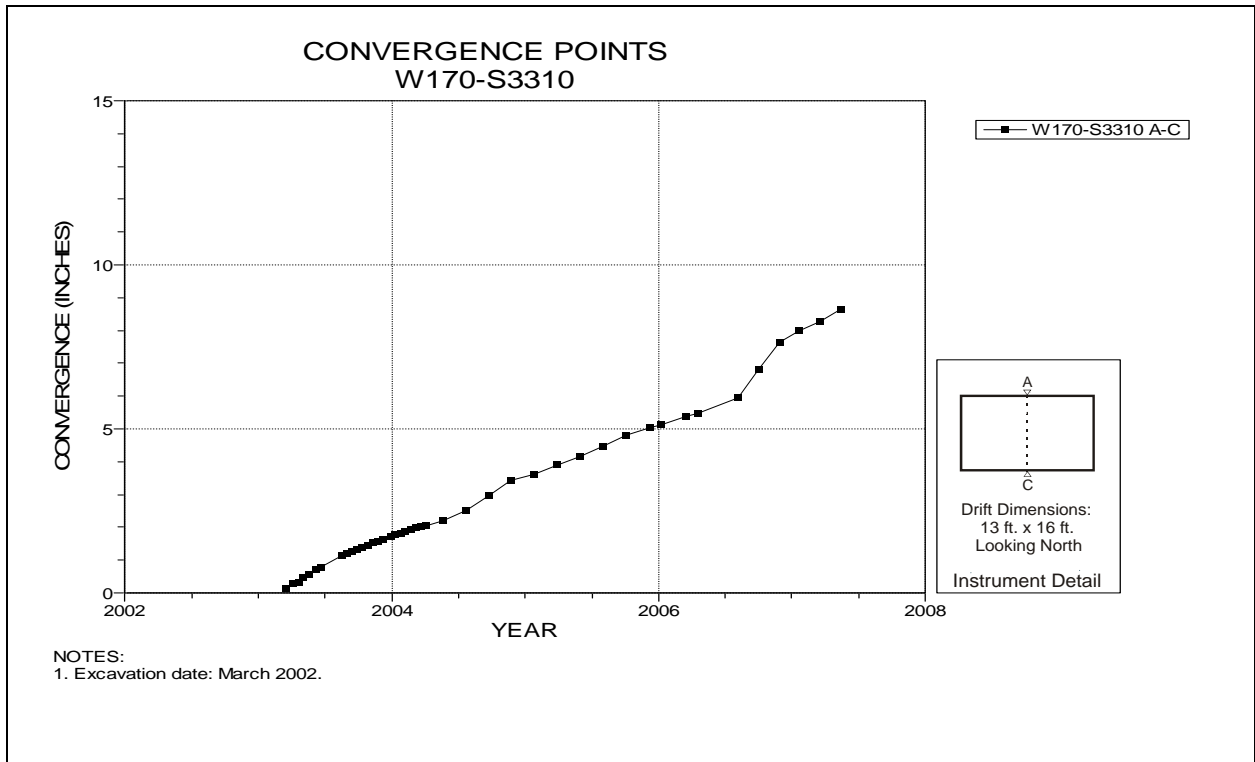


Figure 4-203 Convergence Point Array  
W170 Drift at S3310 Drift Intersection – Roof to Floor

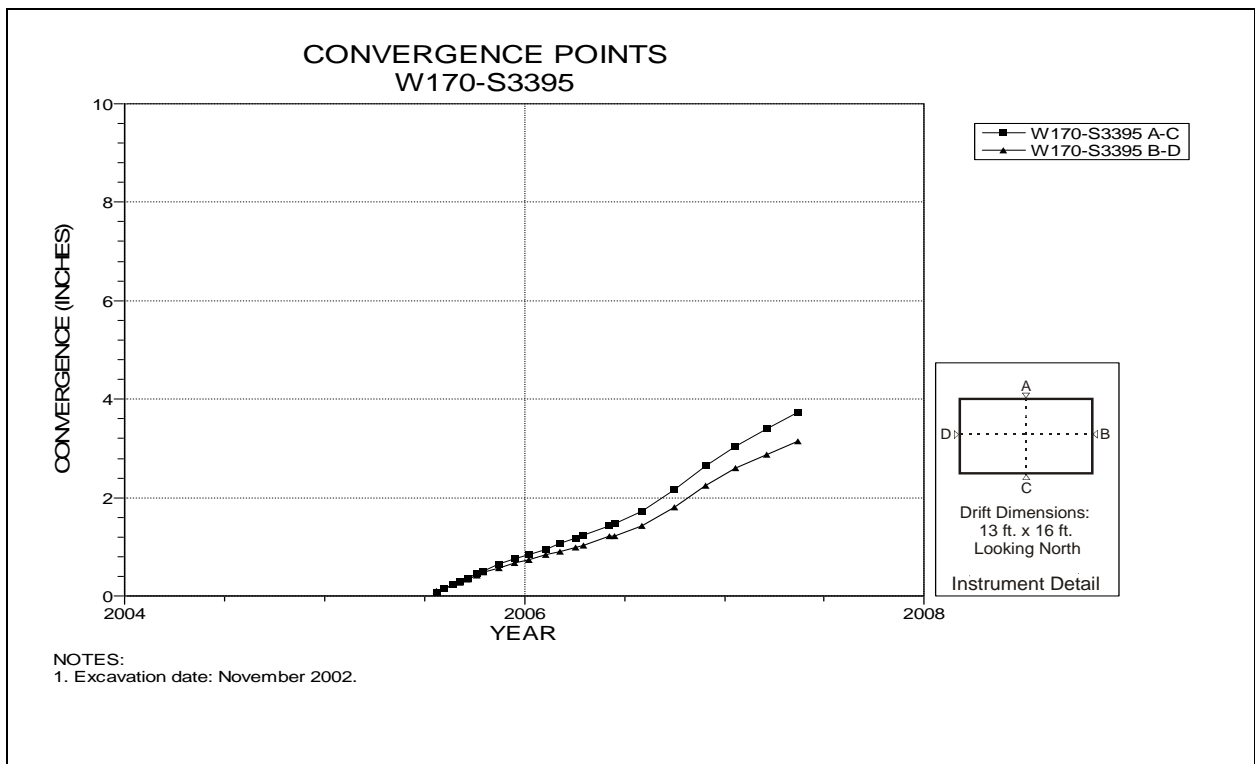


Figure 4-204 Convergence Point Array  
W170 Drift at S3395 Drift – All Chords

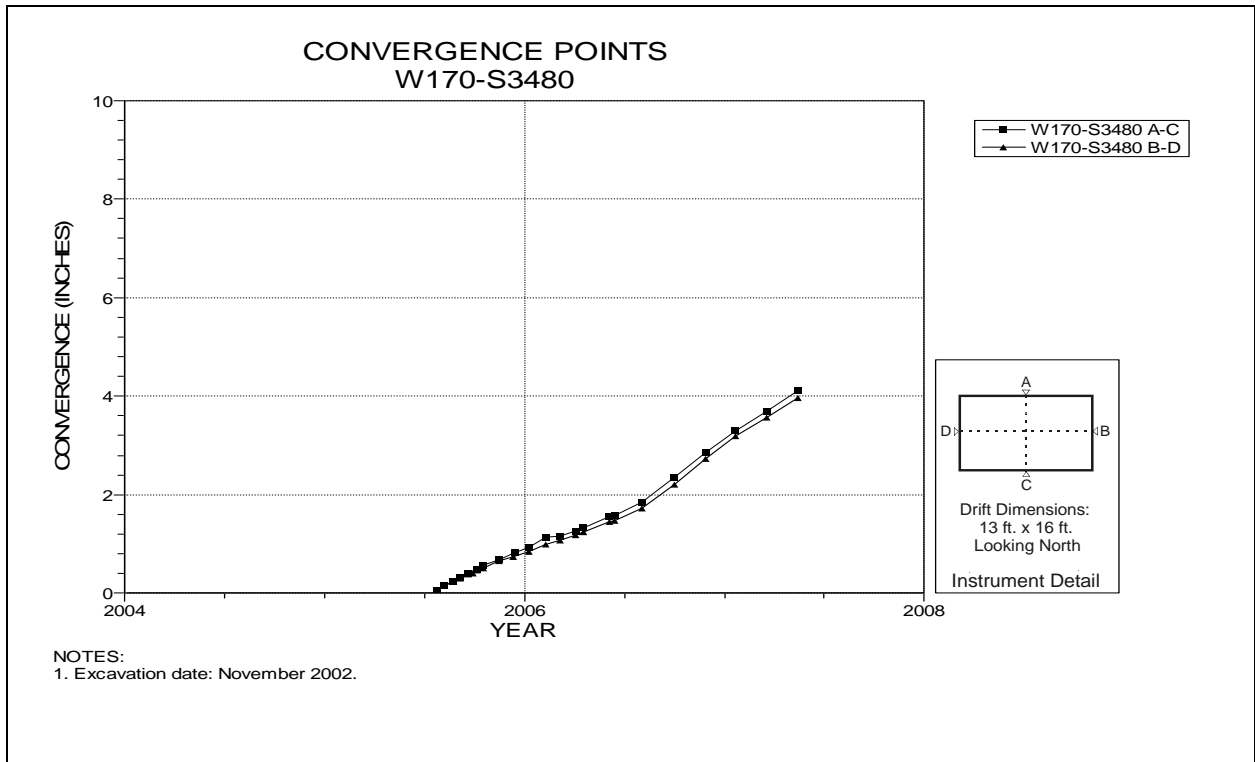


Figure 4-205 Convergence Point Array  
W170 Drift at S3480 Drift – All Chords

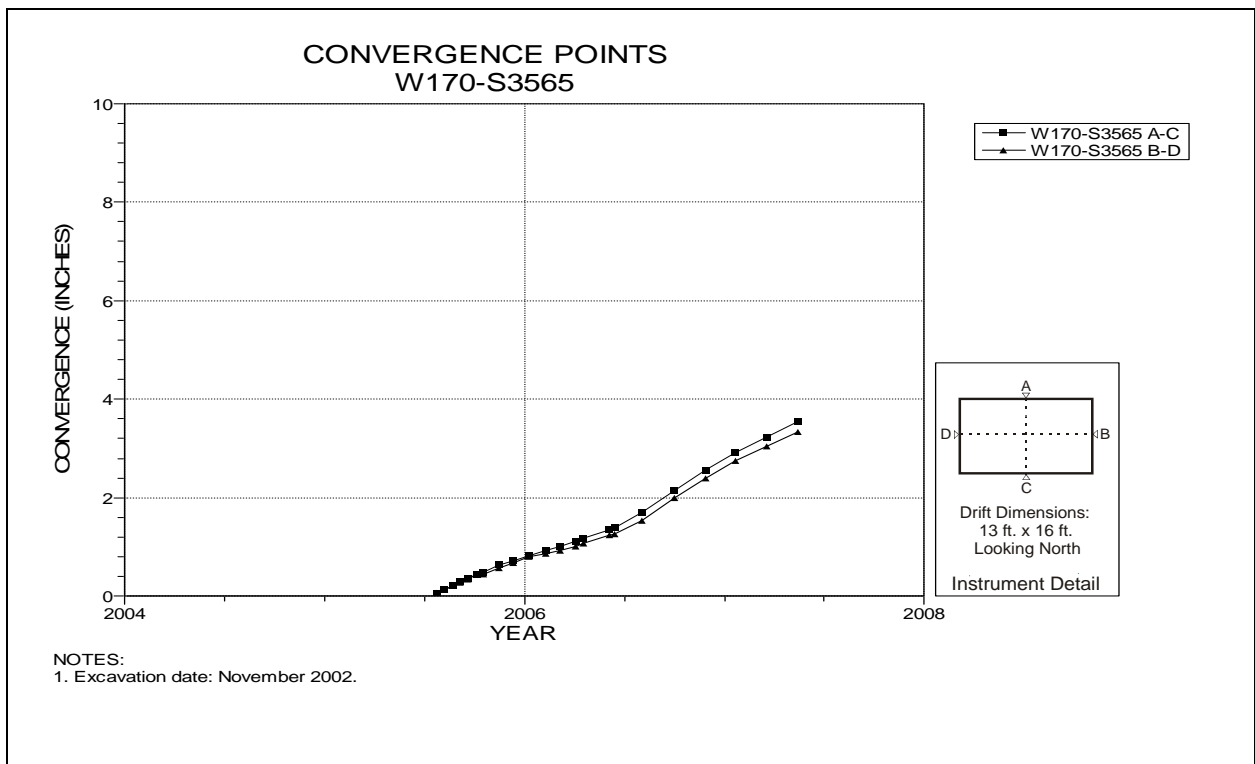


Figure 4-206 Convergence Point Array  
W170 Drift at S3565 – All Chords

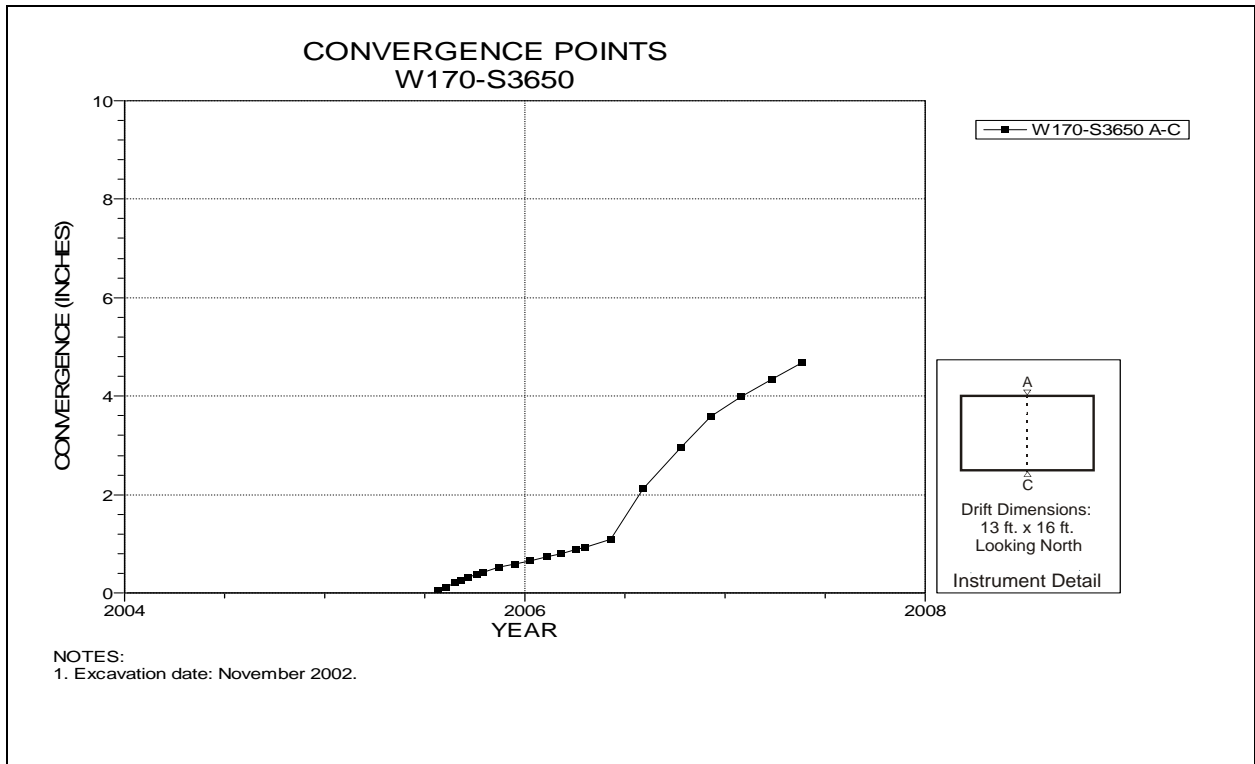


Figure 4-207 Convergence Point Array  
W170 Drift at S3650 Drift Intersection – Roof to Floor

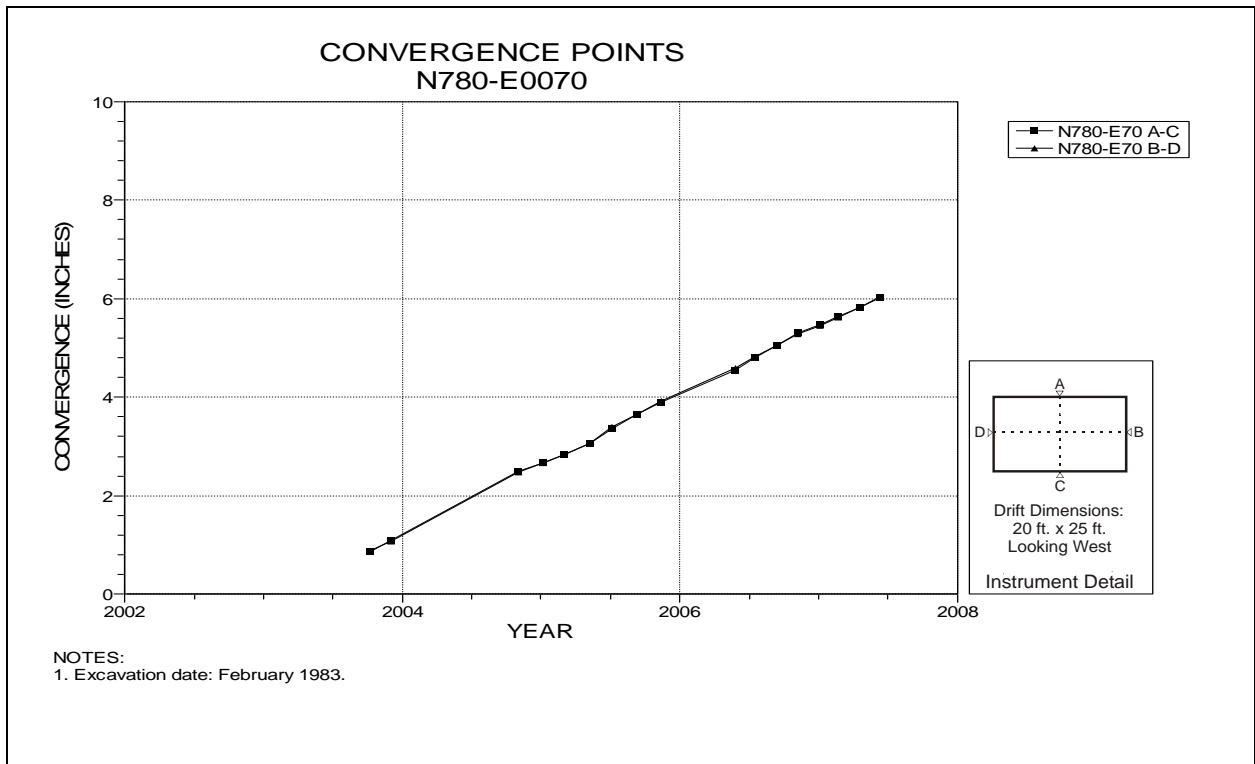


Figure 4-208 Convergence Point Array  
N780 Drift at E70 – All Chords

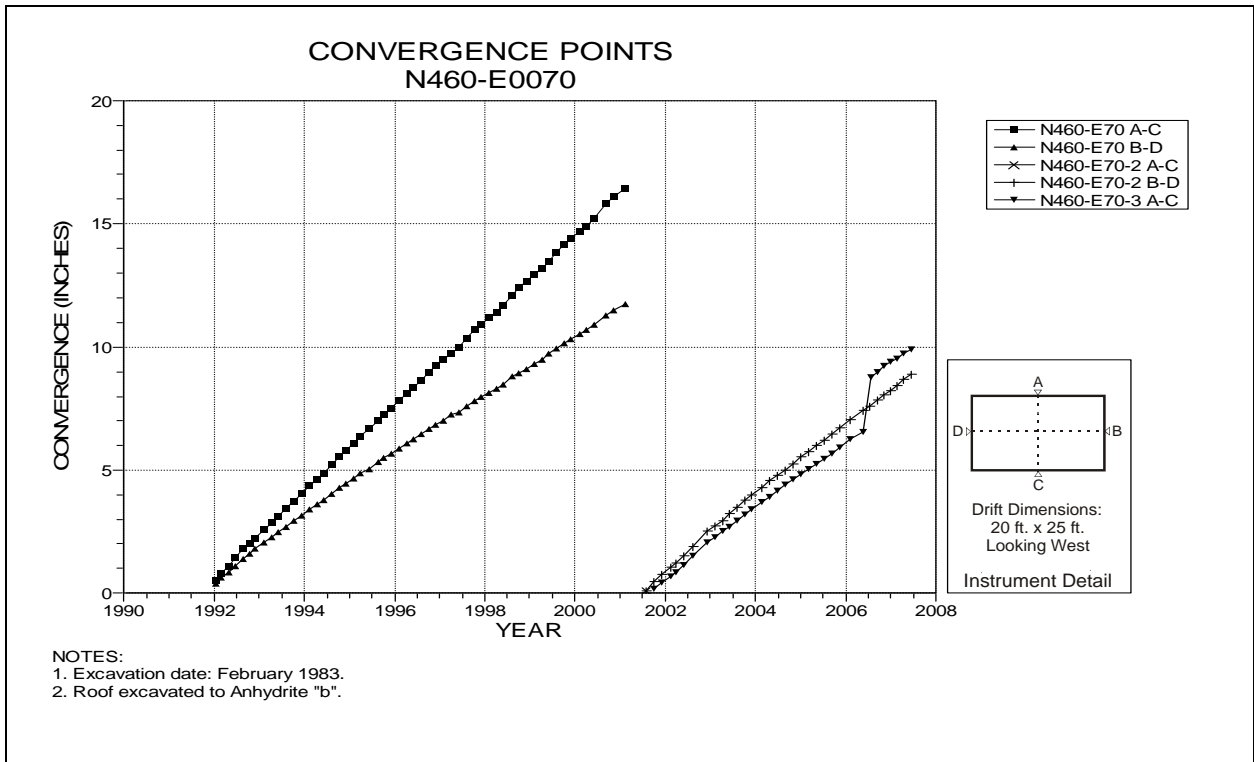


Figure 4-209 Convergence Point Array  
N460 Drift at E70 – All Chords

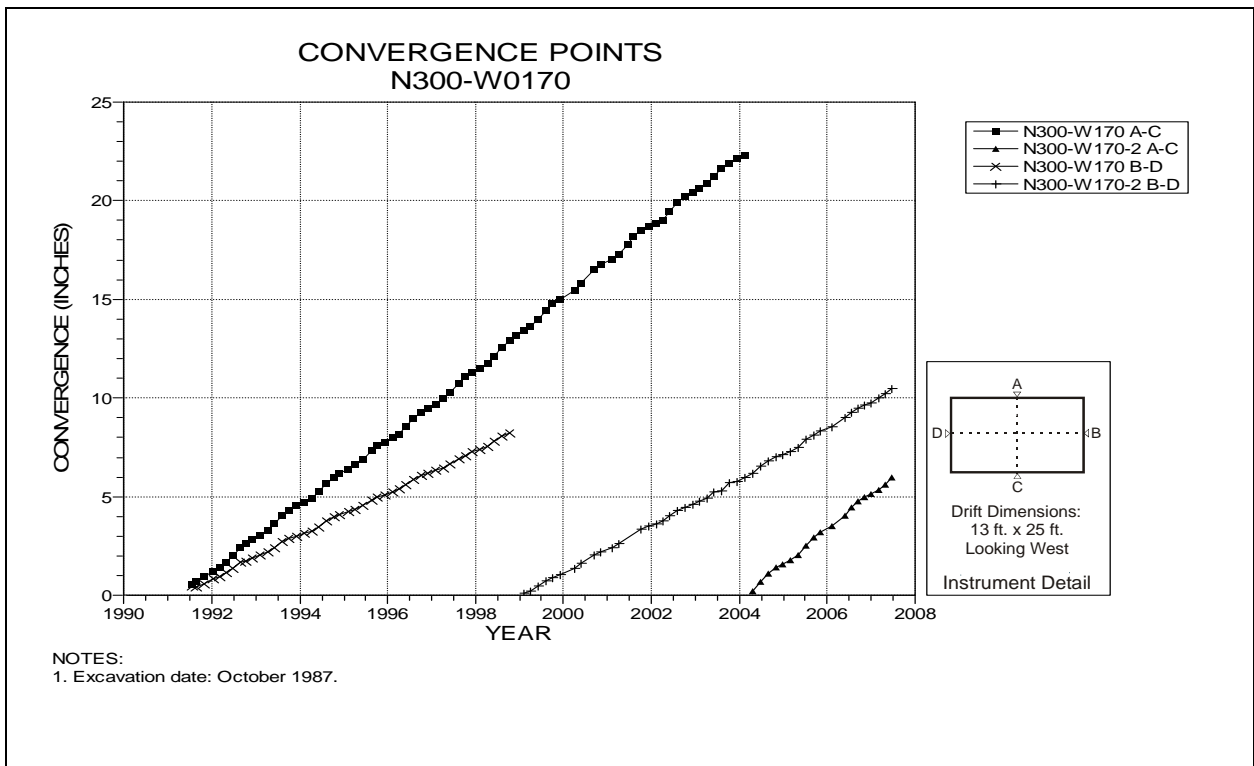


Figure 4-210 Convergence Point Array  
N300 Drift at W170 – All Chords

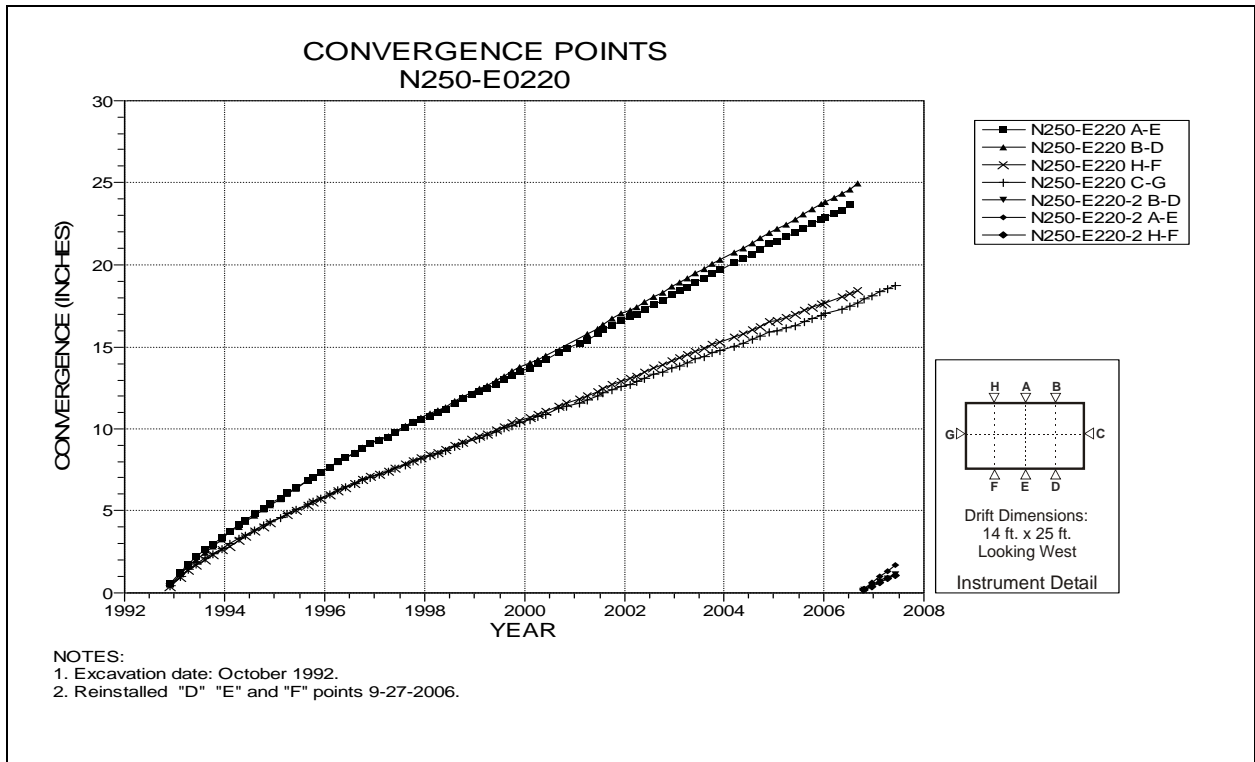


Figure 4-211 Convergence Point Array  
N250 Drift at E220 – All Chords

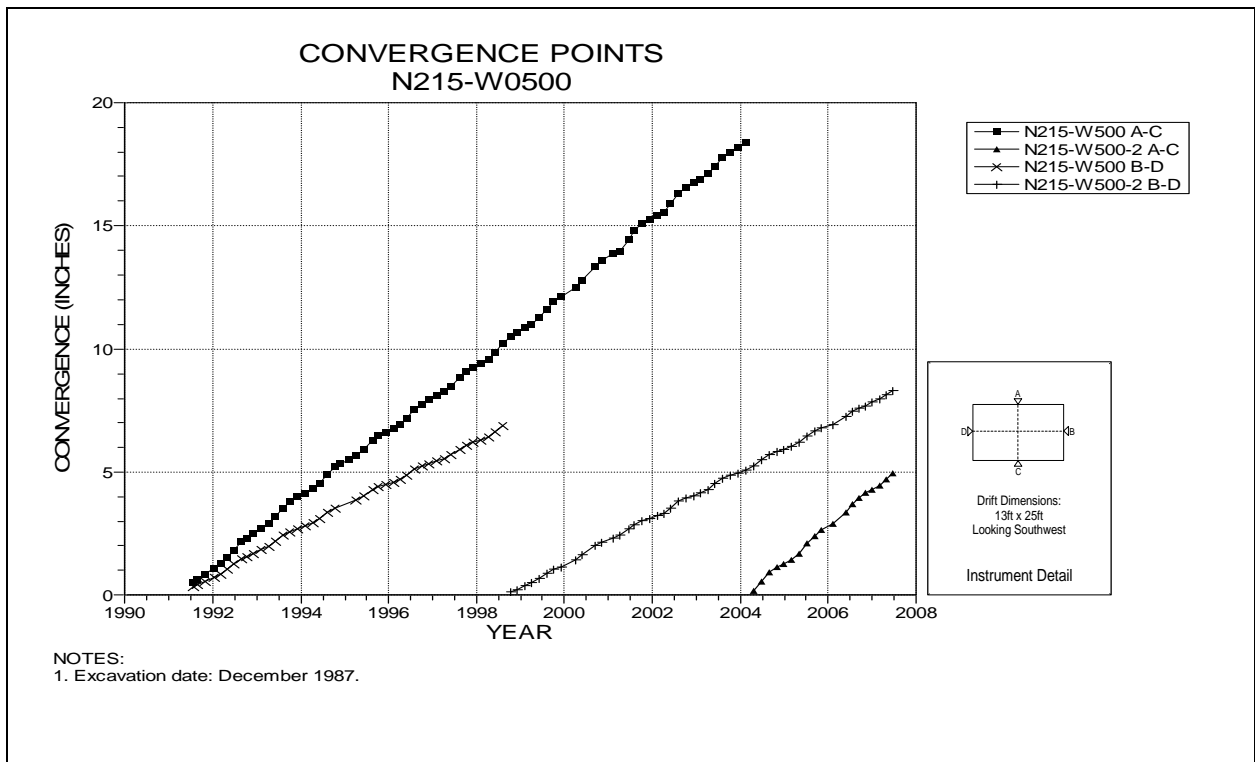


Figure 4-212 Convergence Point Array  
N215 Drift at W500 – All Chords

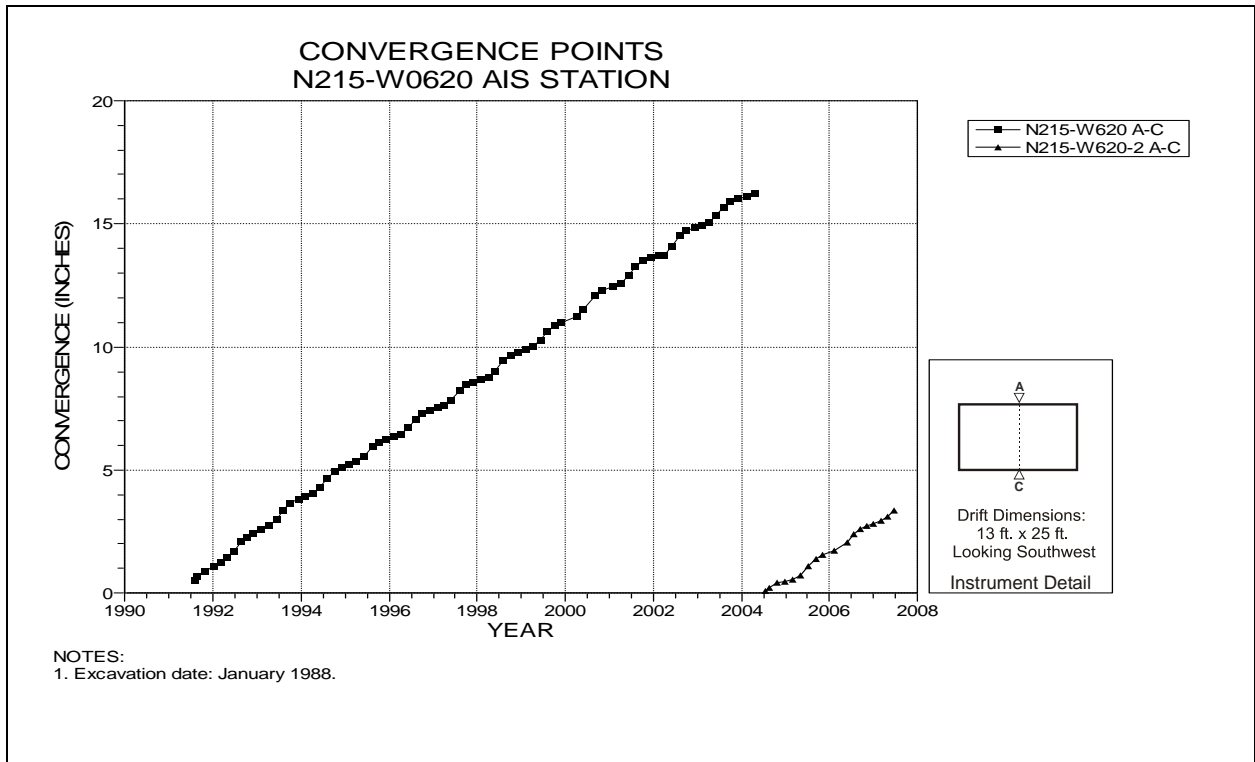


Figure 4-213 Convergence Point Array  
N215 Drift at W620 at Air Intake Shaft – Roof to Floor

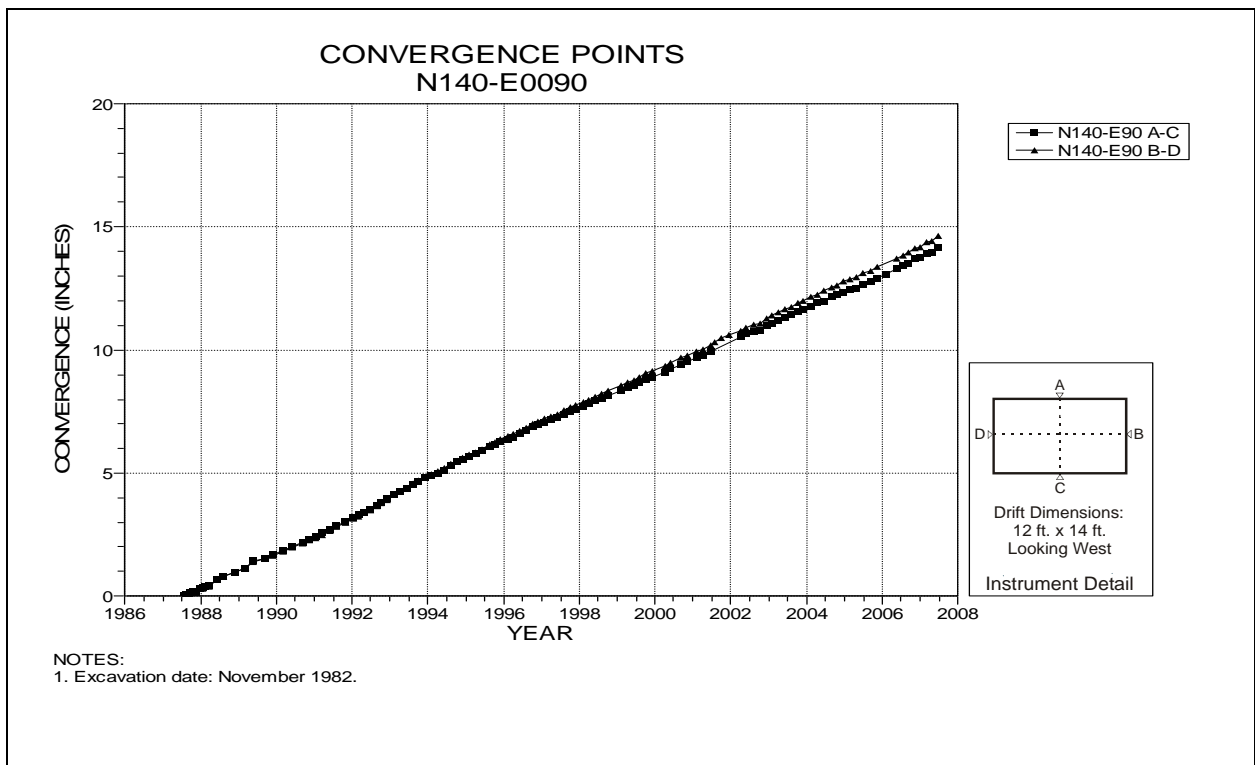


Figure 4-214 Convergence Point Array  
N140 Drift at E90 – All Chords

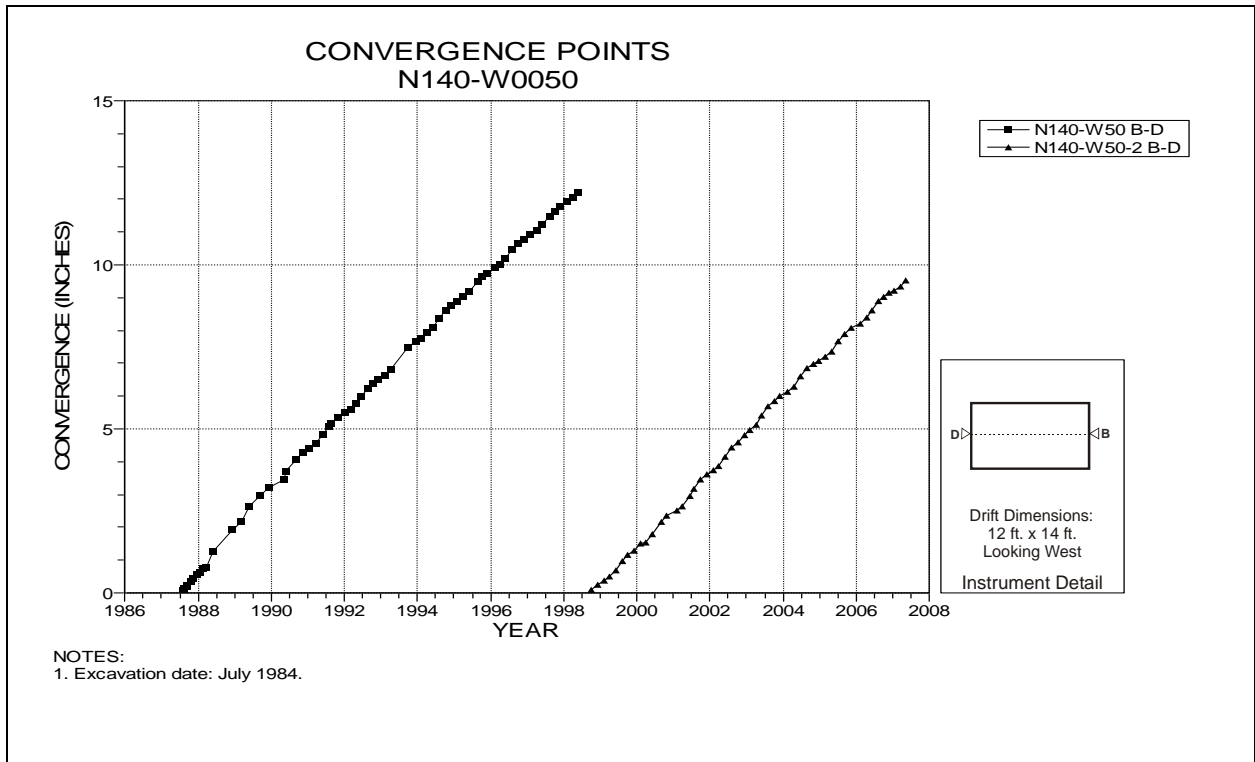


Figure 4-215 Convergence Point Array  
N140 Drift at W50 – Rib to Rib

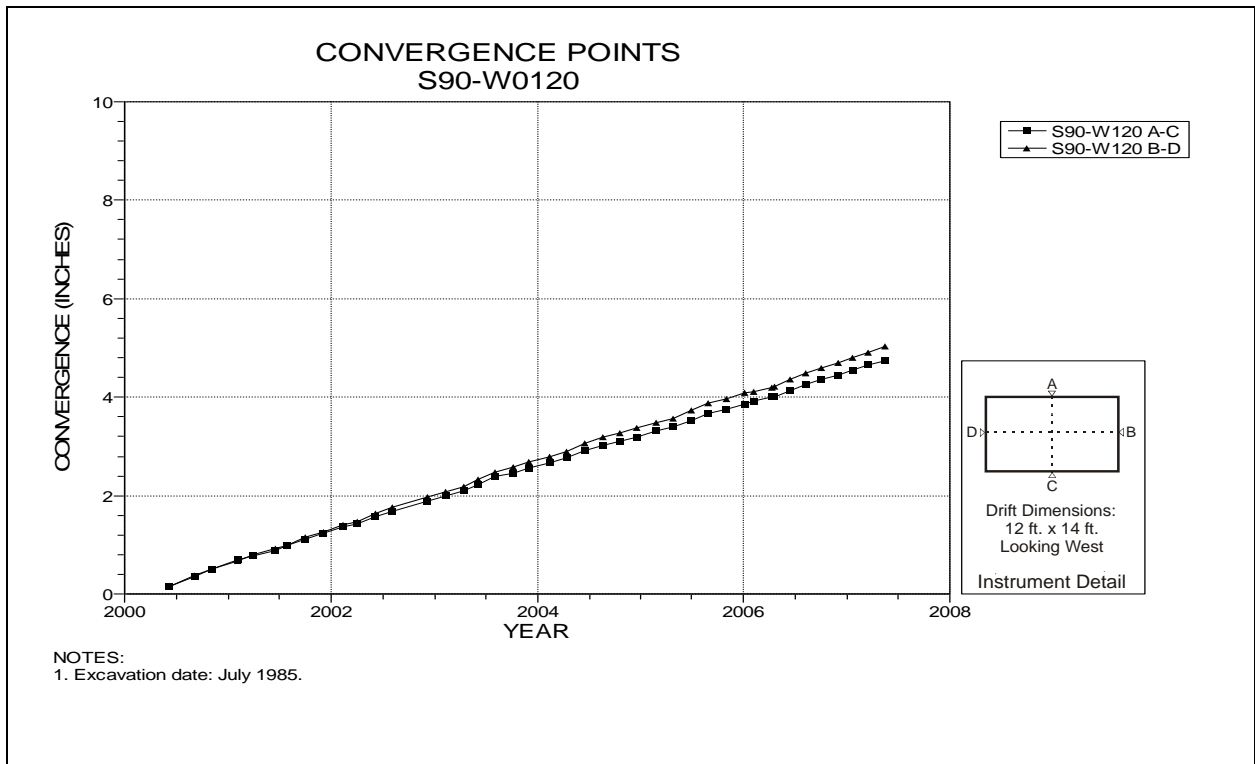


Figure 4-216 Convergence Point Array  
S90 Drift at W120 – All Chords



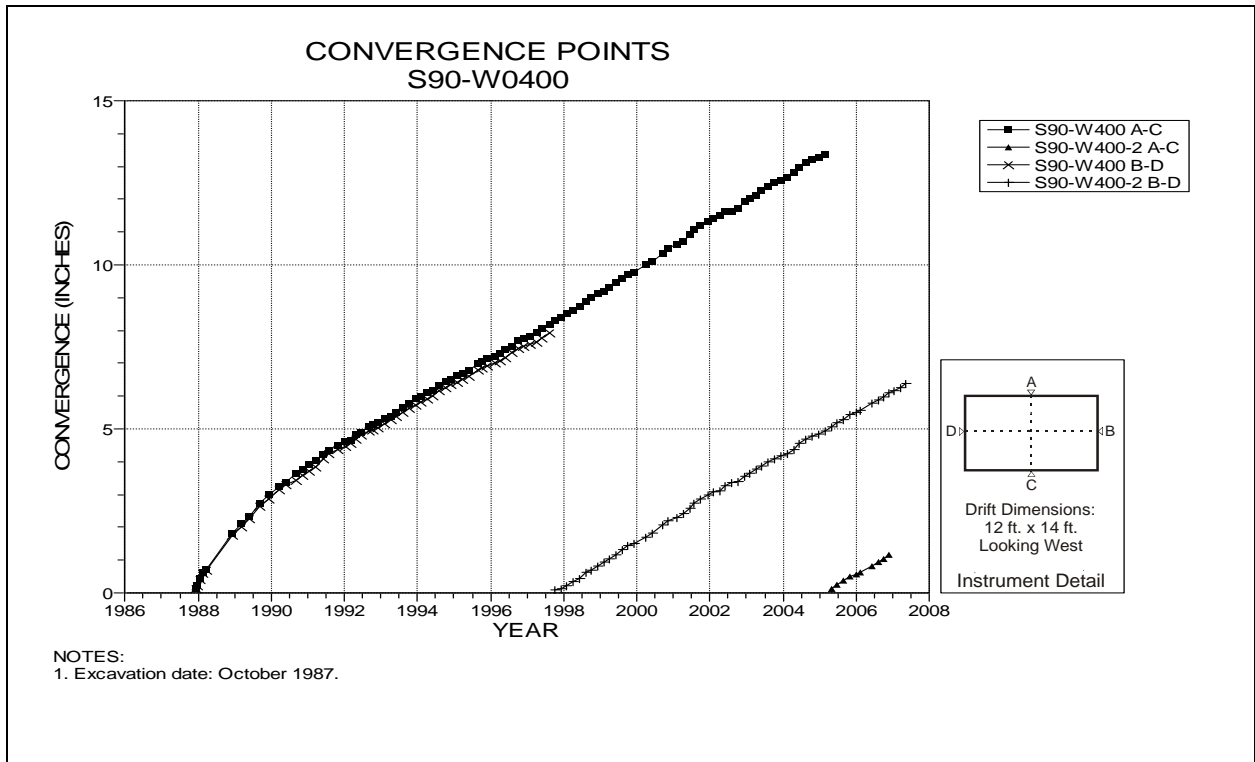


Figure 4-217 Convergence Point Array  
S90 Drift at W400 – All Chords

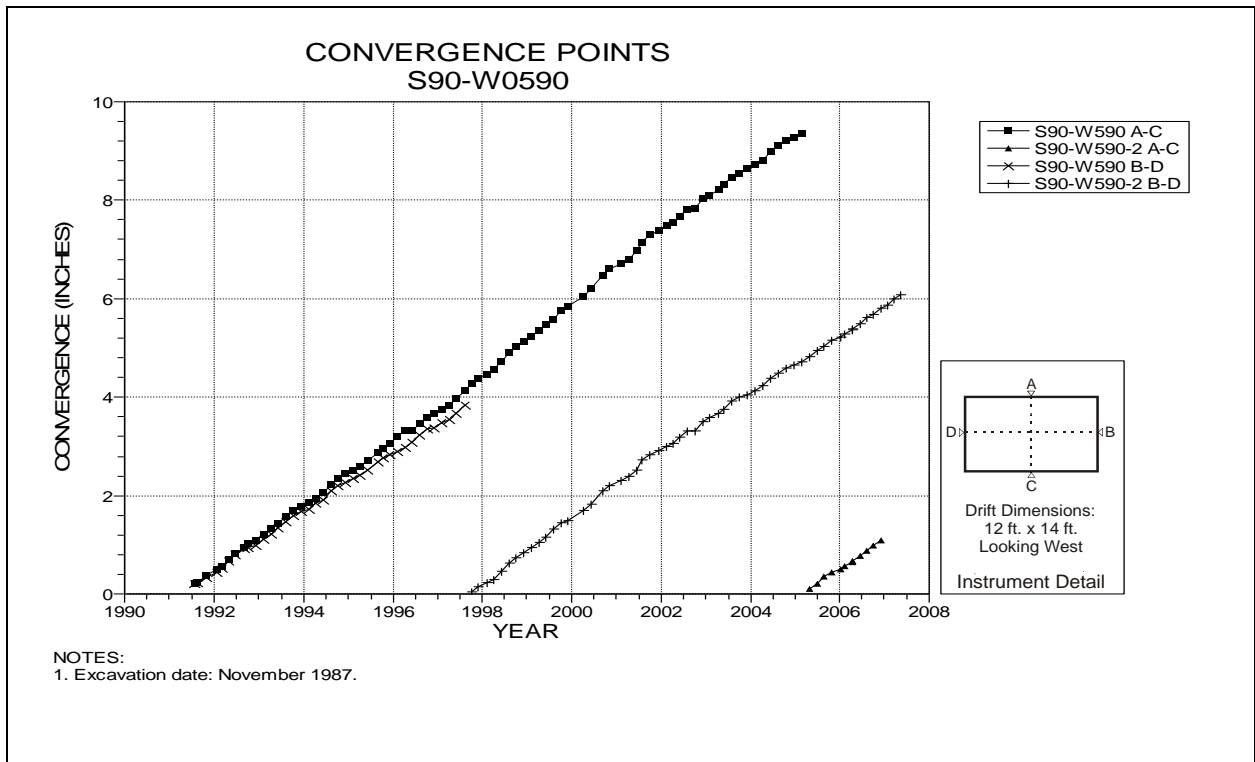


Figure 4-218 Convergence Point Array  
S90 Drift at W590 – All Chords

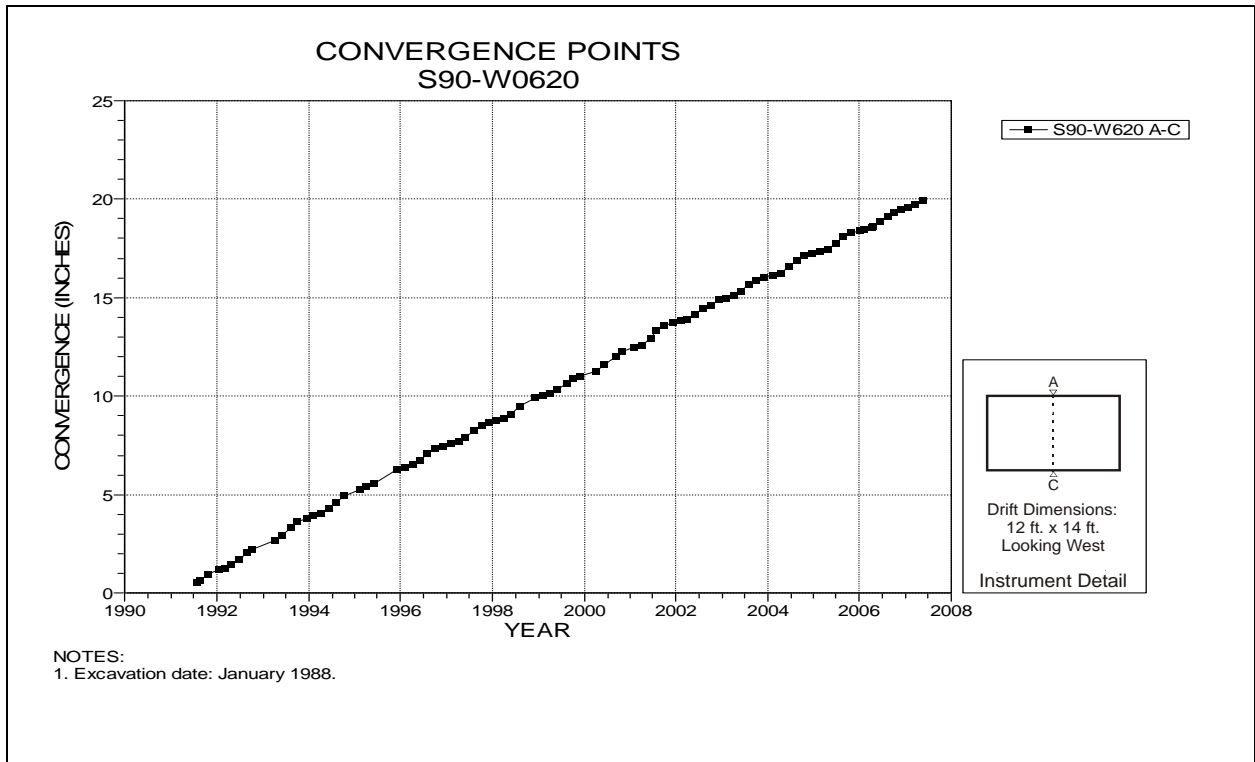


Figure 4-219 Convergence Point Array  
S90 Drift at W620 – Roof to Floor

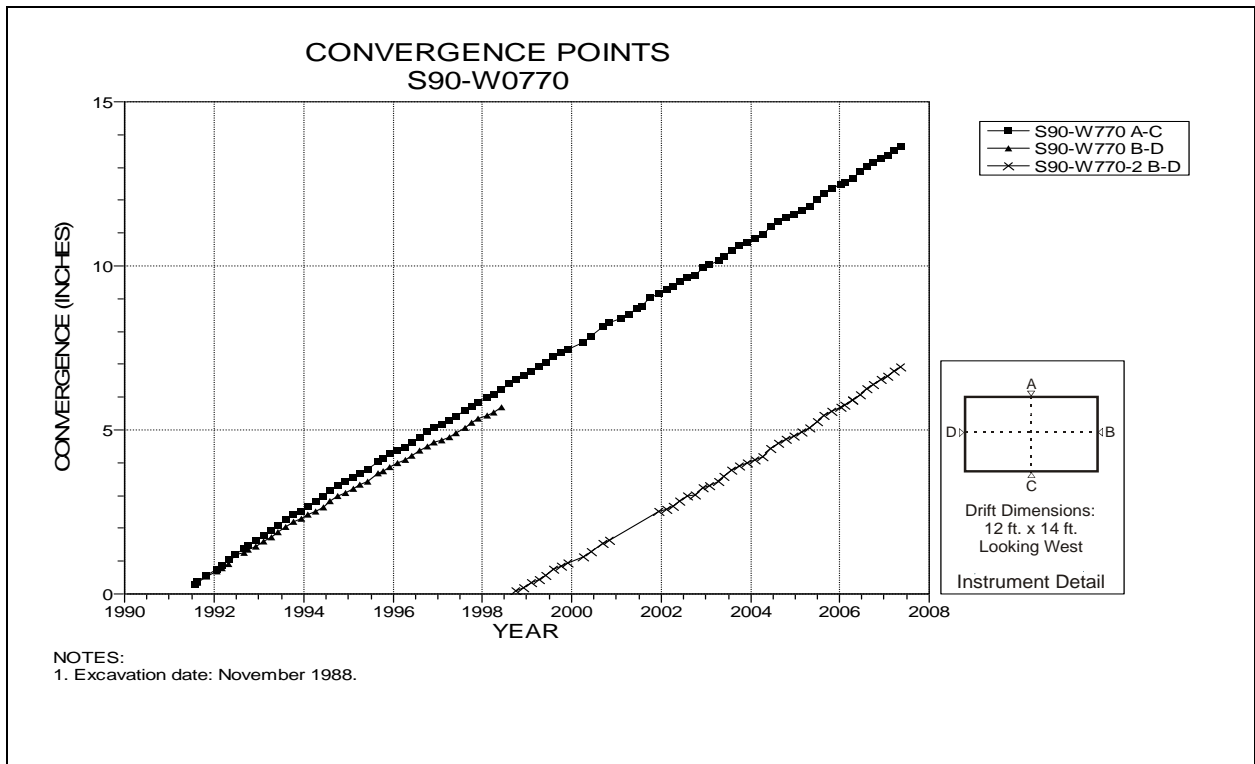


Figure 4-220 Convergence Point Array  
S90 Drift at W770 – All Chords

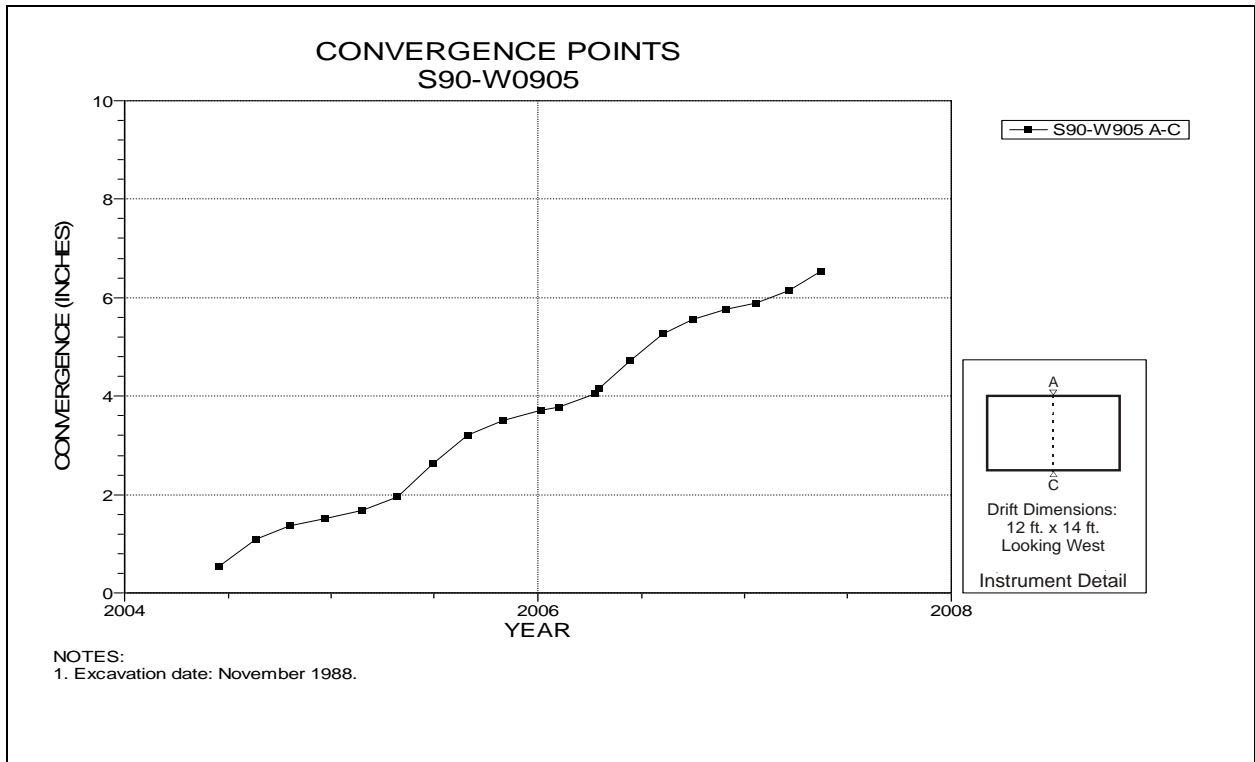


Figure 4-221 Convergence Point Array  
S90 Drift at W905 – Roof to Floor

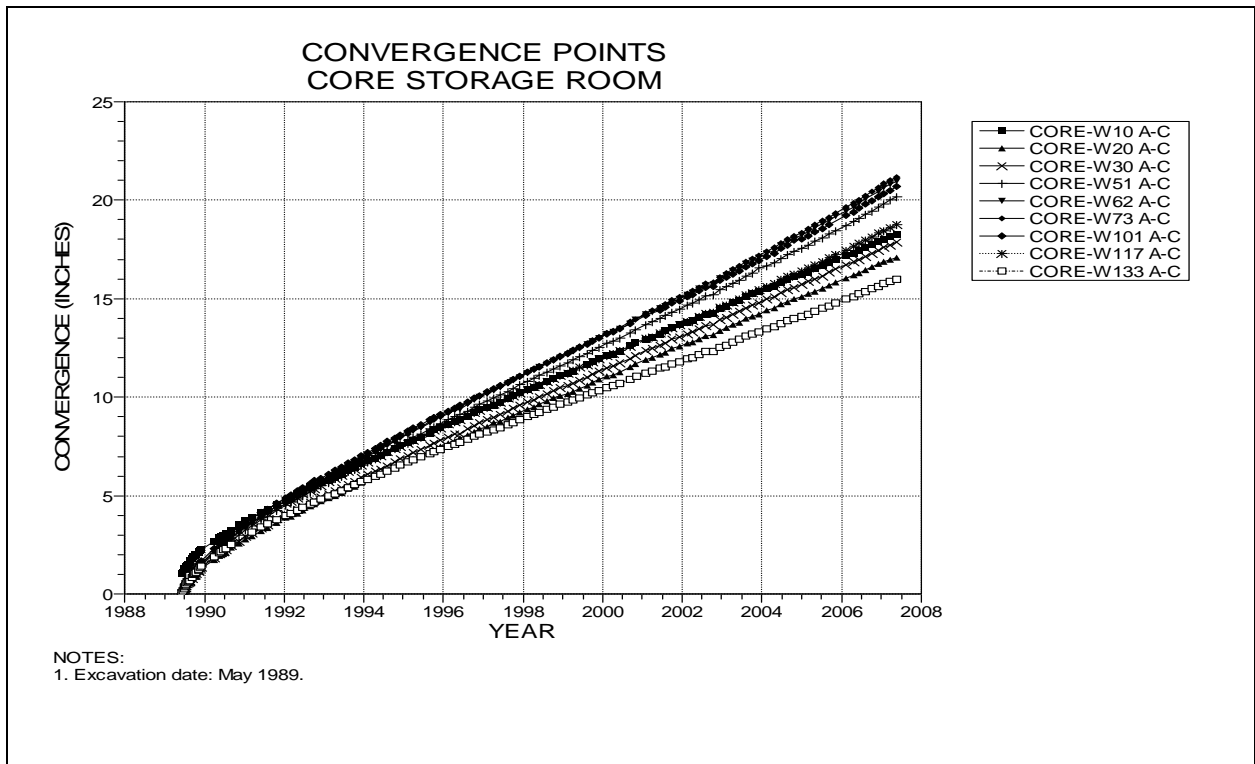


Figure 4-222 Convergence Point Array  
S400 Core Storage Library – All Chords

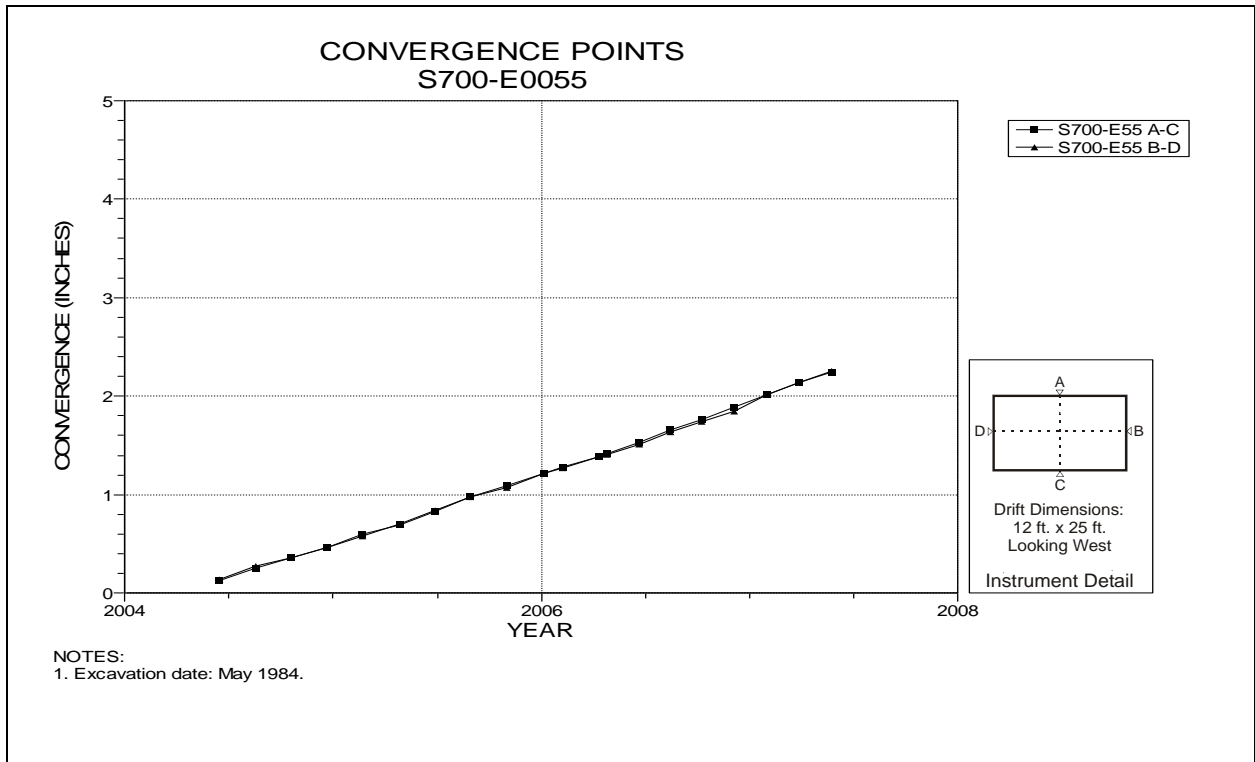


Figure 4-223 Convergence Point Array  
S700 Drift at E55 – All Chords

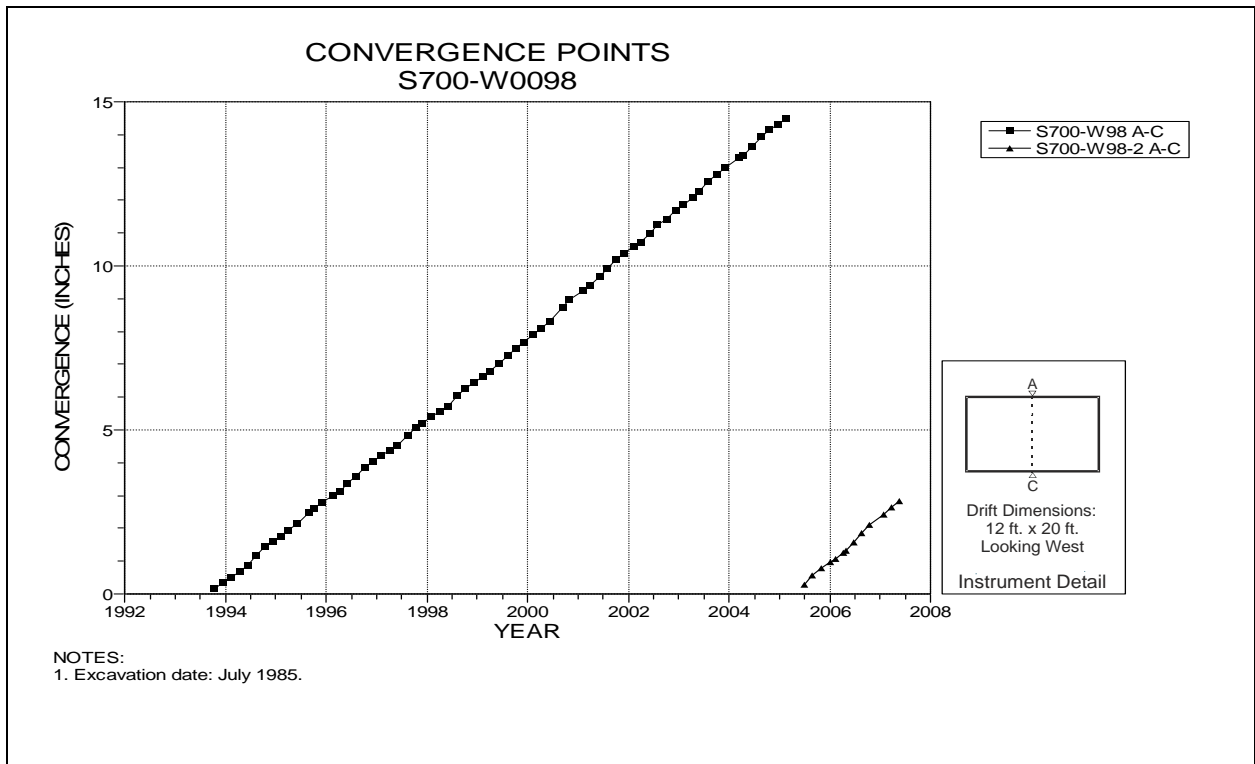


Figure 4-224 Convergence Point Array  
S700 Drift at W98 – Roof to Floor

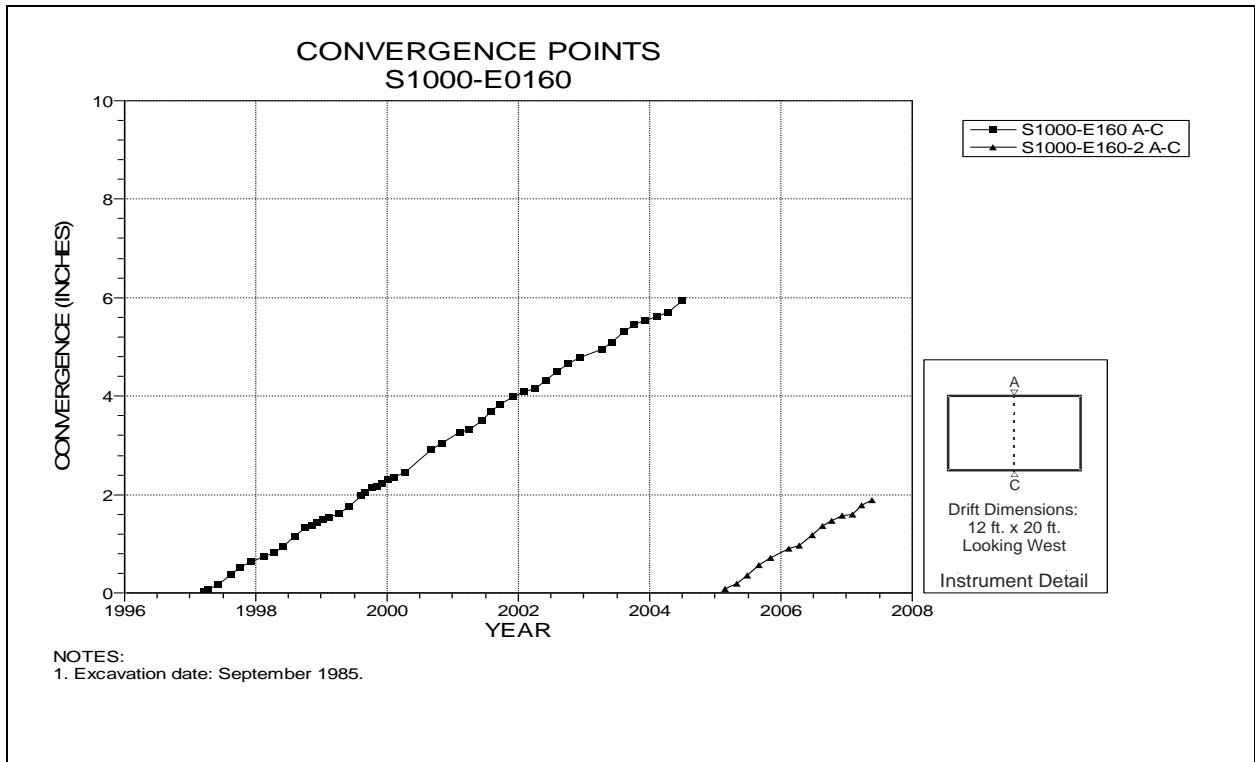


Figure 4-225 Convergence Point Array  
S1000 Drift at E160 – Roof to Floor

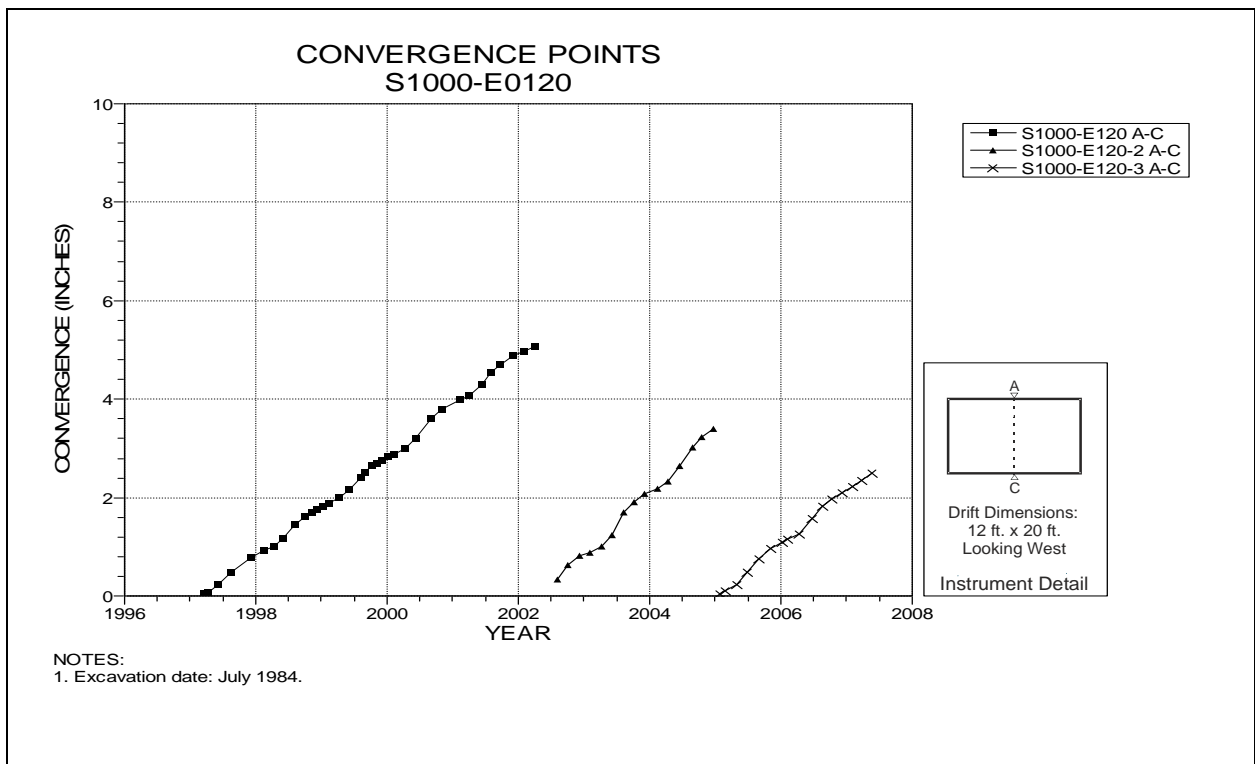


Figure 4-226 Convergence Point Array  
S1000 Drift at E120 – Roof to Floor

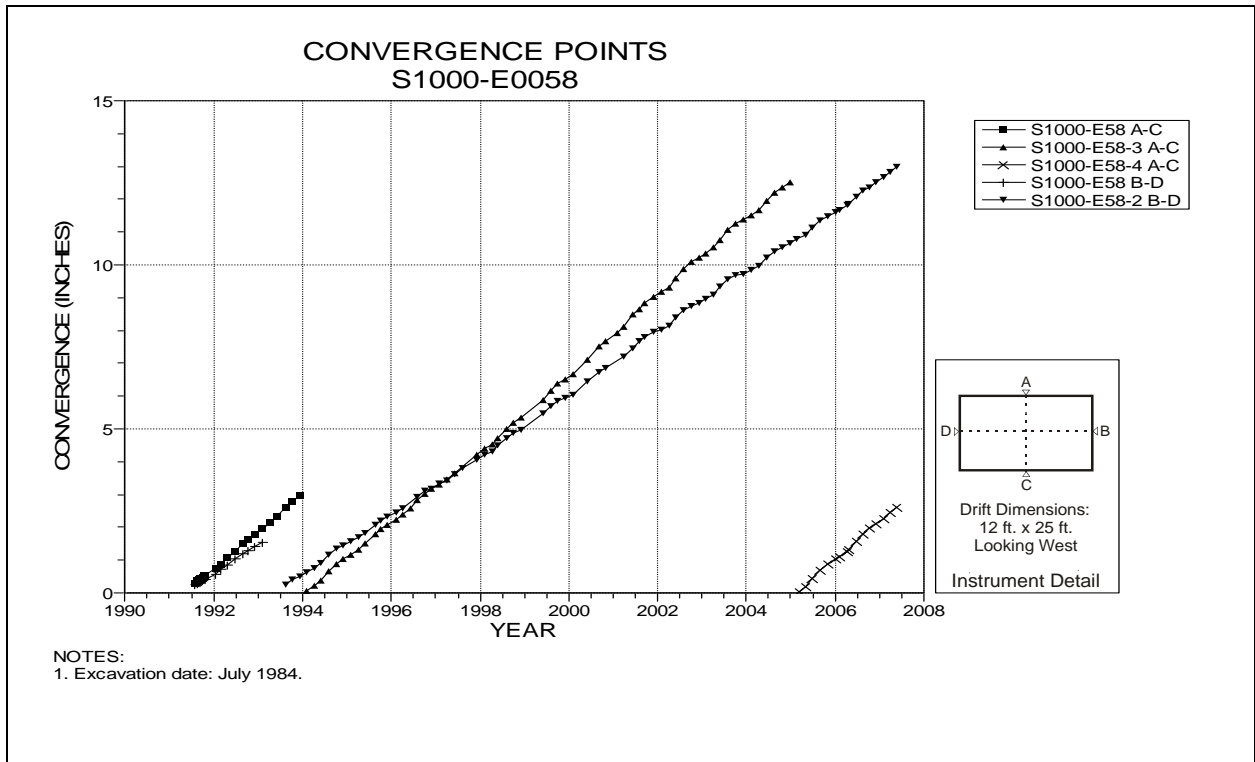


Figure 4-227 Convergence Point Array  
S1000 Drift at E58 – All Chords

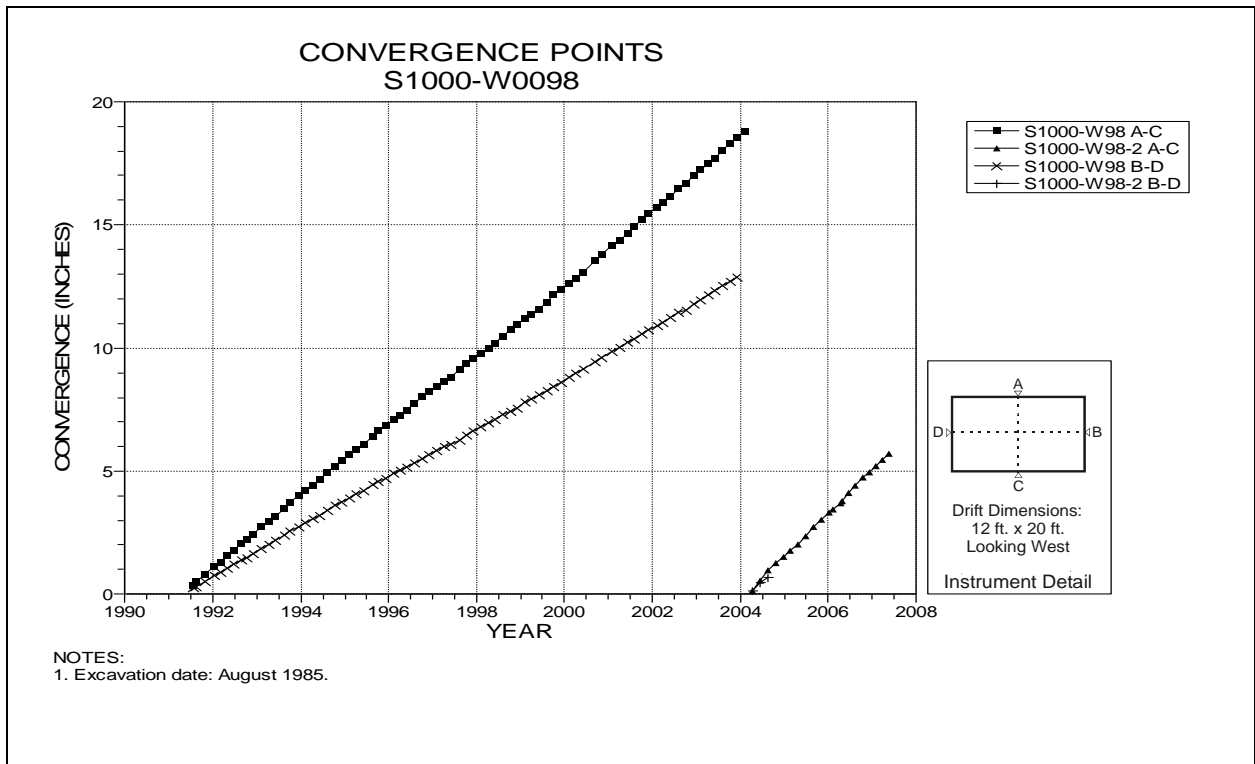


Figure 4-228 Convergence Point Array  
S1000 Drift at W98 – All Chords

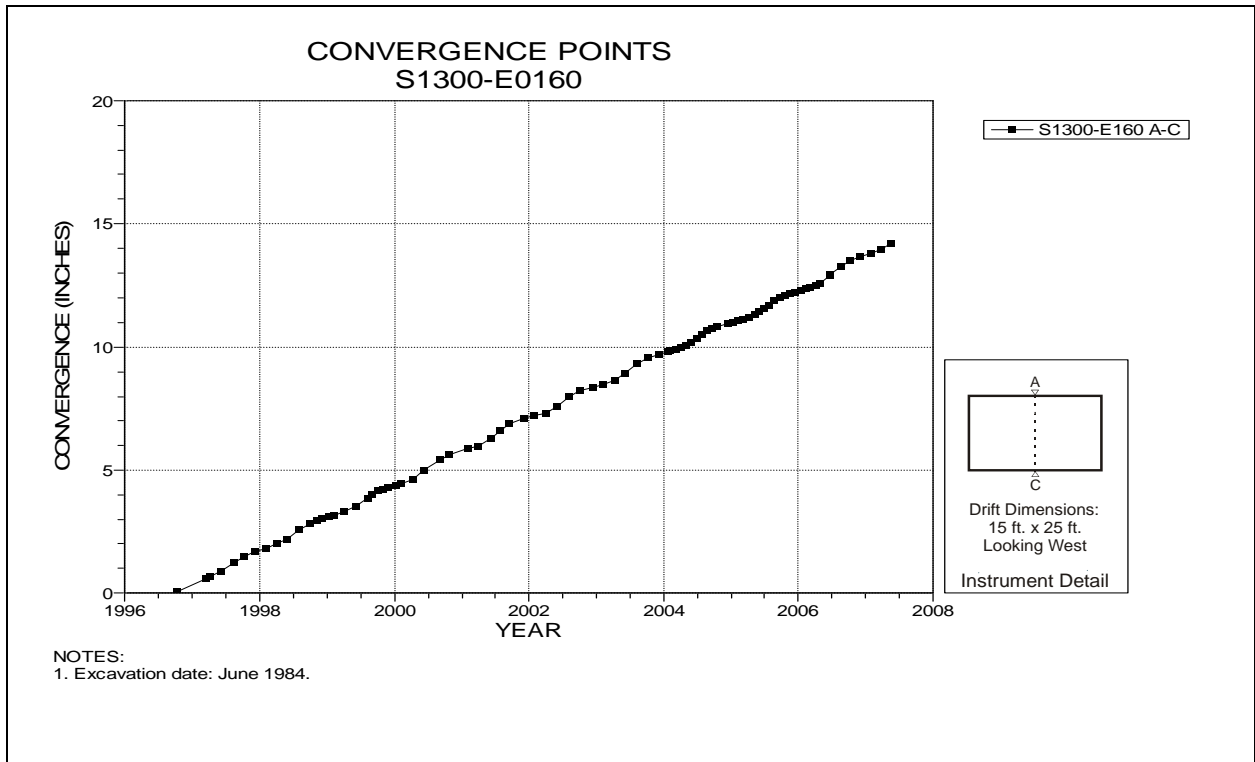


Figure 4-229 Convergence Point Array  
S1300 Drift at E160 – Roof to Floor

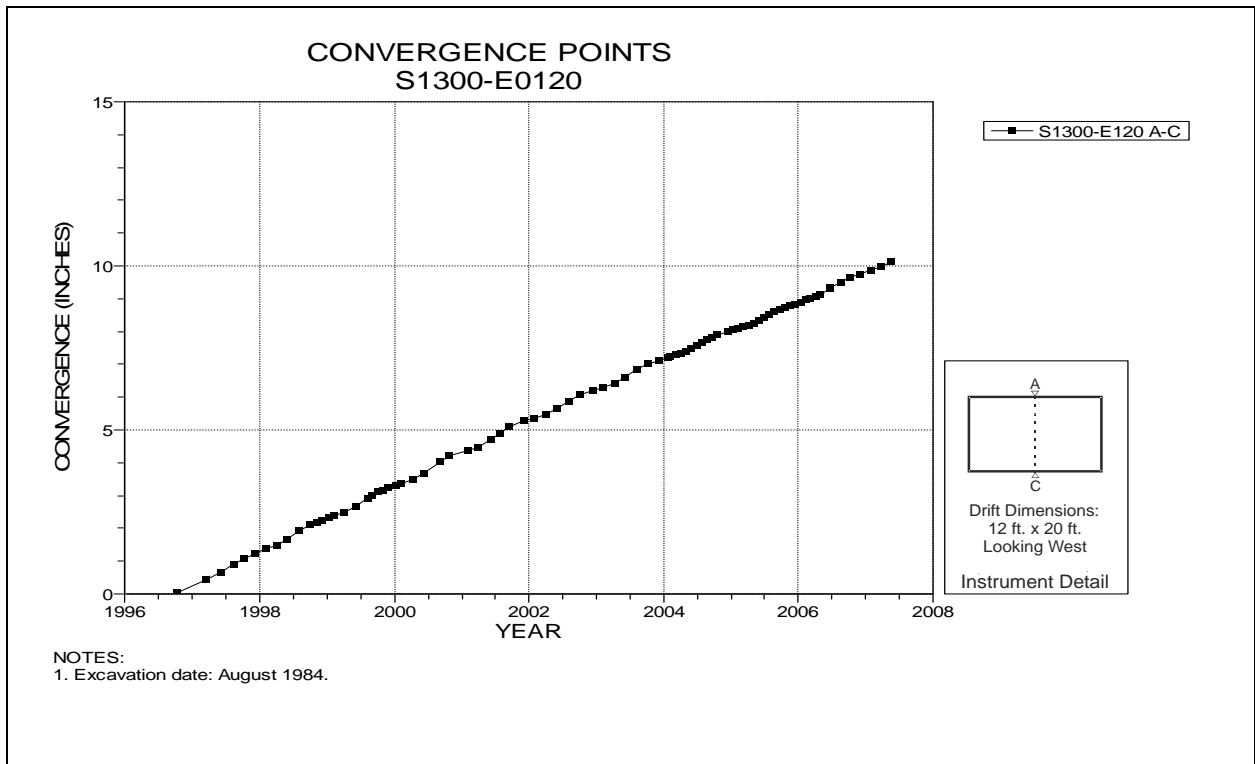


Figure 4-230 Convergence Point Array  
S1300 Drift at E120 – Roof to Floor

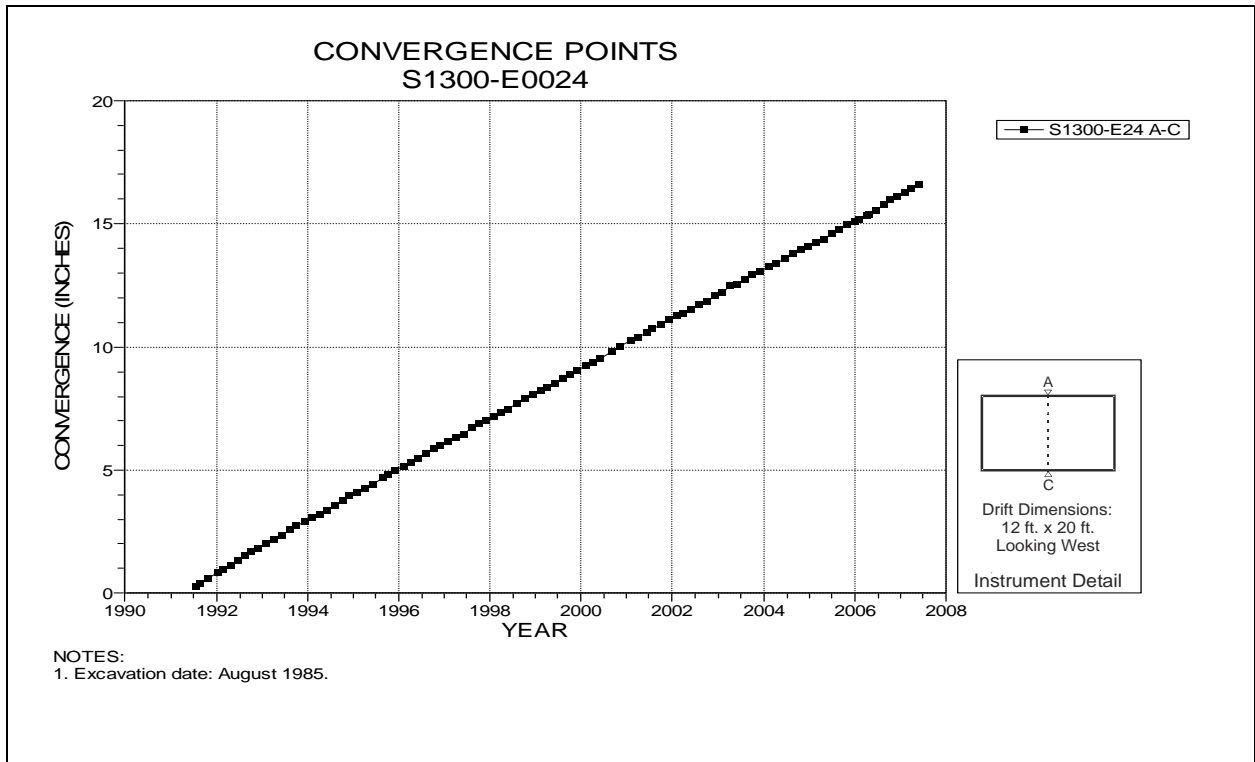


Figure 4-231 Convergence Point Array  
S1300 Drift at E24 – Roof to Floor

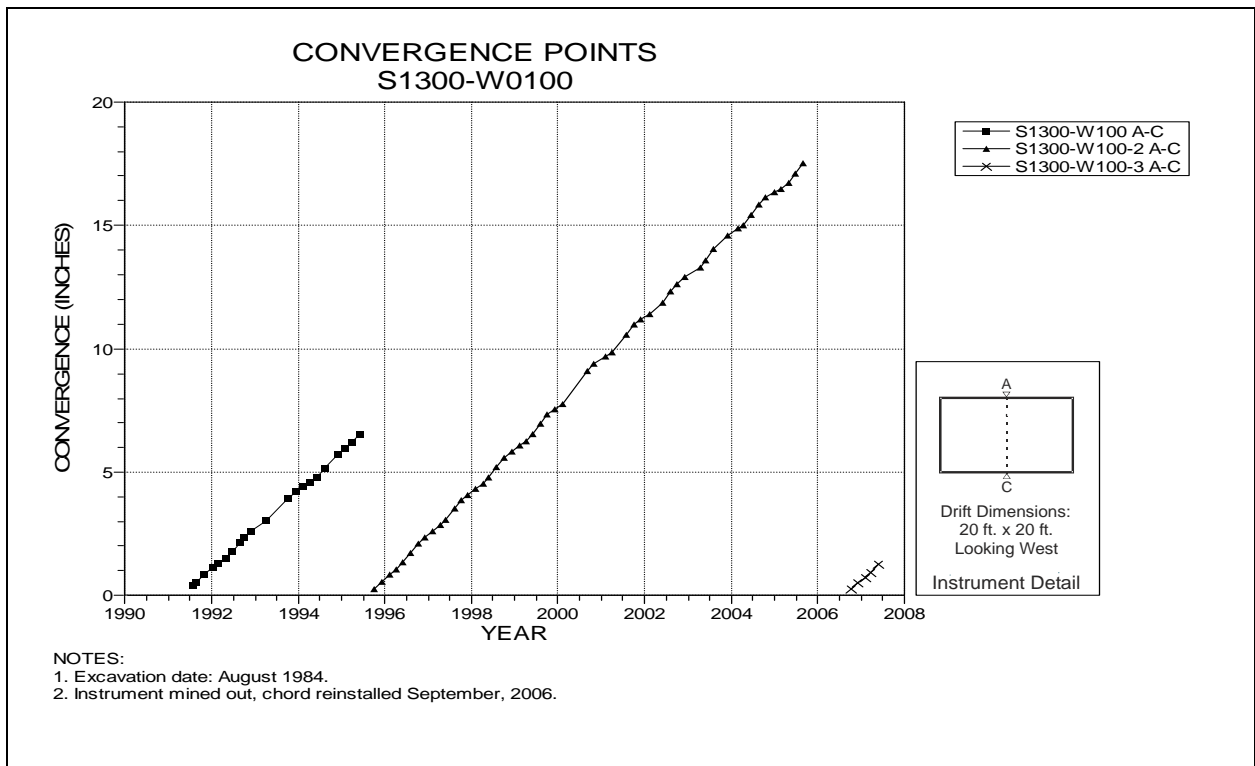


Figure 4-232 Convergence Point Array  
S1300 Drift at W100 – Roof to Floor



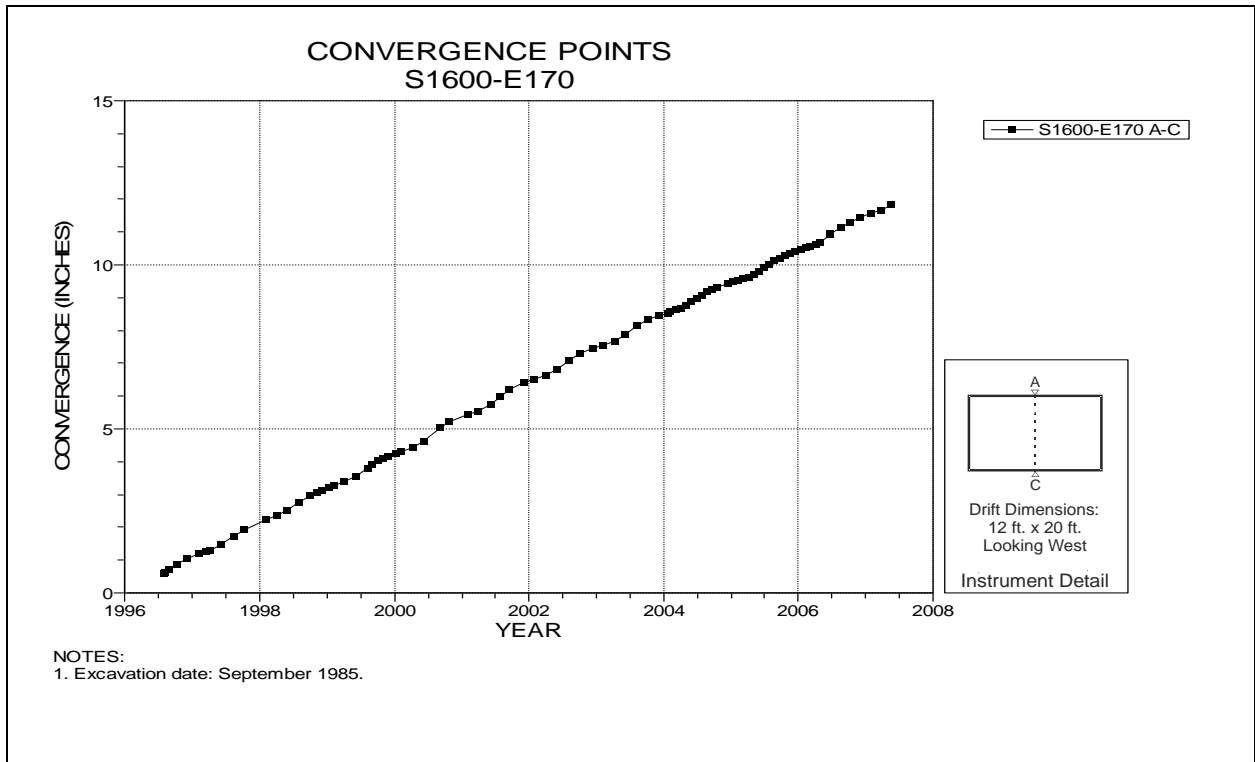


Figure 4-233 Convergence Point Array  
S1600 Drift at E170 – Roof to Floor

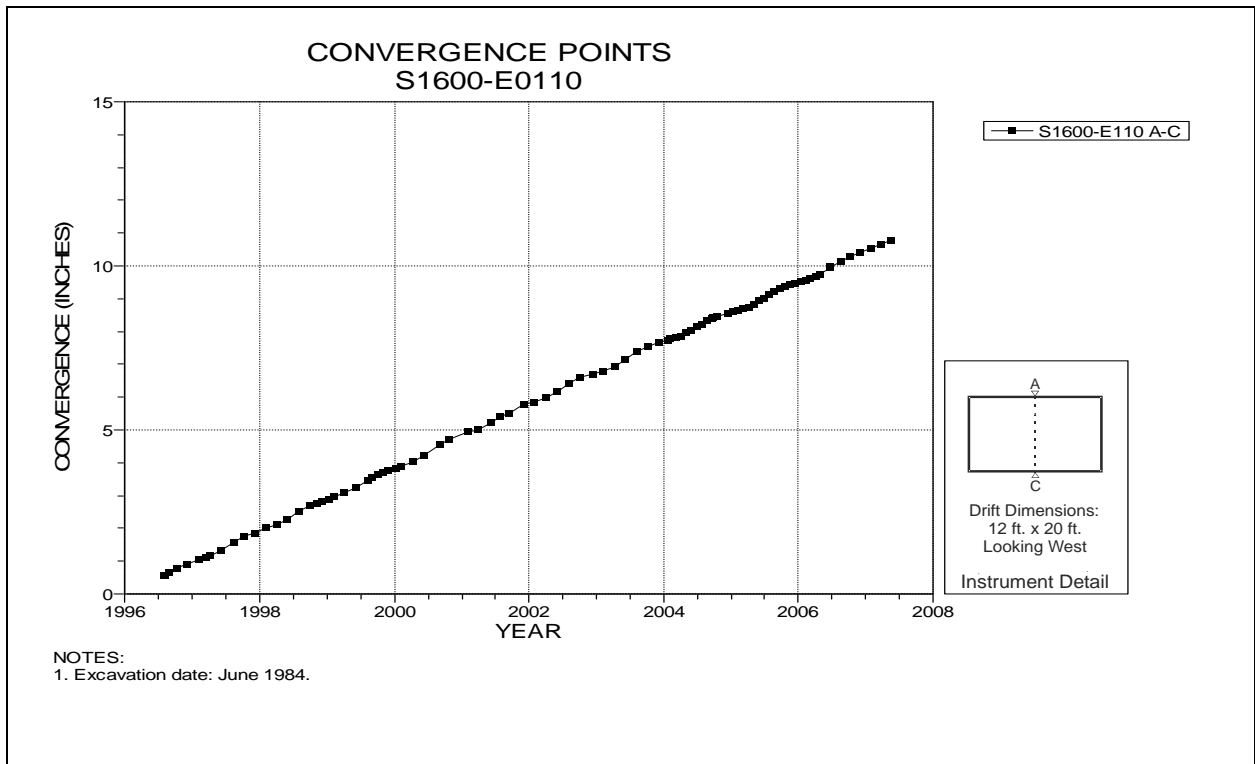


Figure 4-234 Convergence Point Array  
S1600 Drift at E110 – Roof to Floor

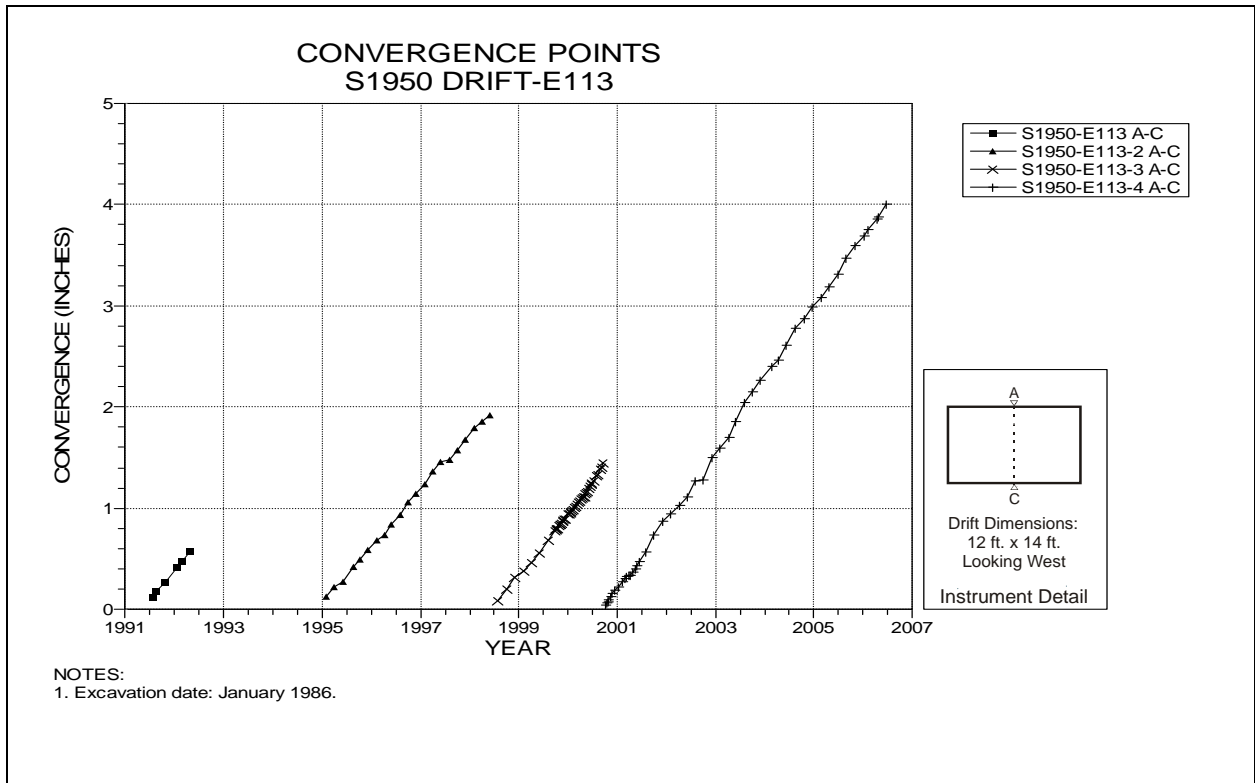


Figure 4-235 Convergence Point Array  
S1950 Drift at E113 – Roof to Floor

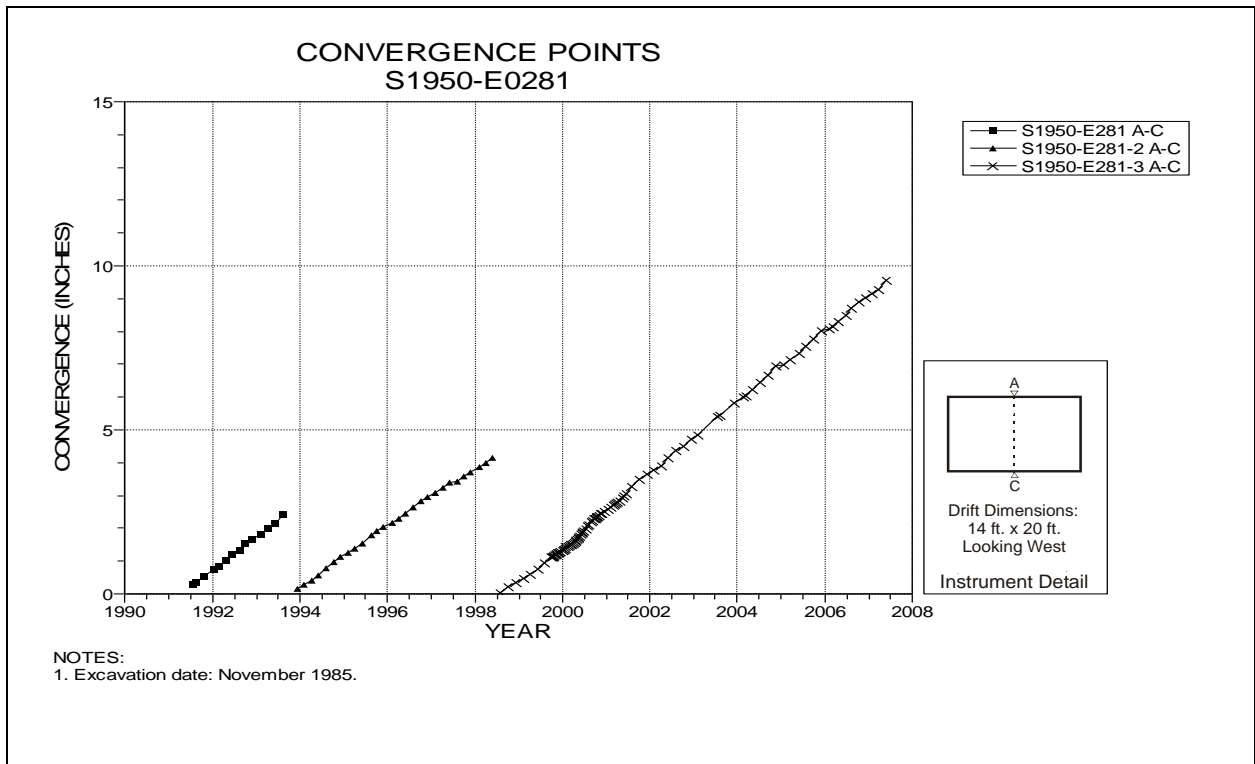


Figure 4-236 Convergence Point Array  
S1950 Drift at E281 – Roof to Floor

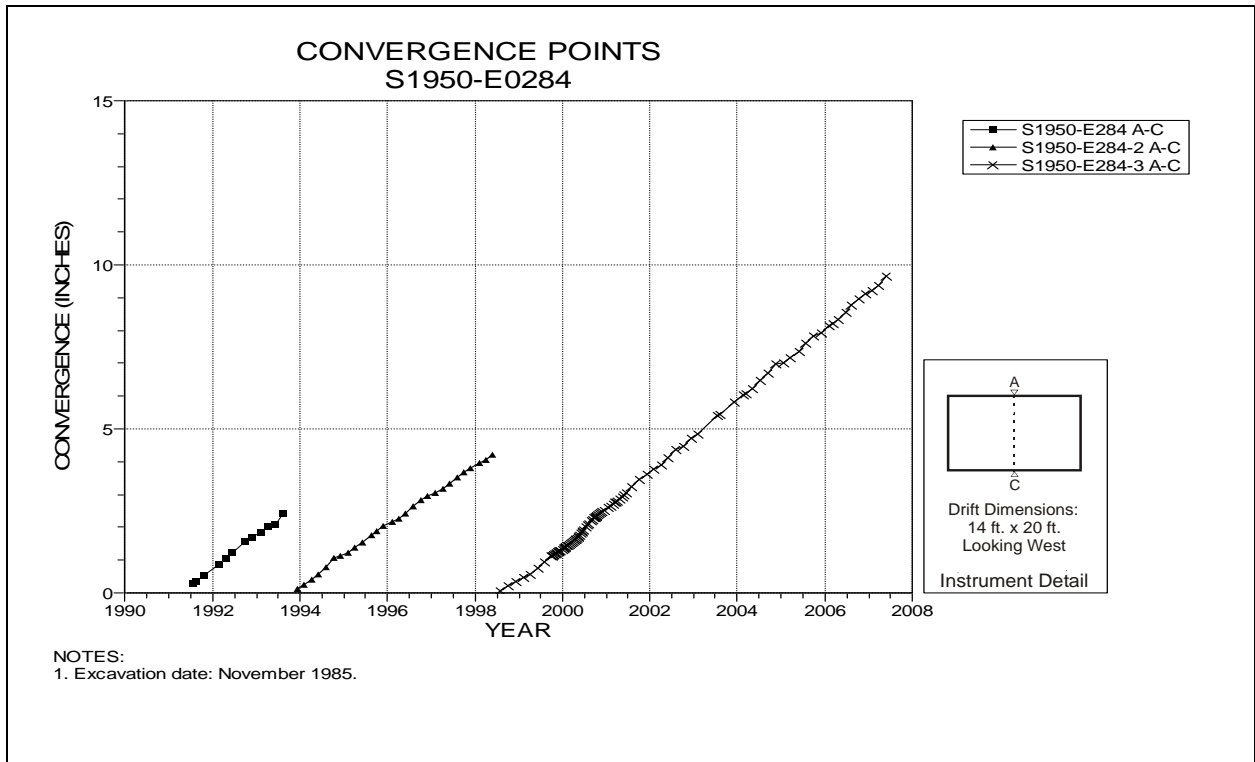


Figure 4-237 Convergence Point Array  
S1950 Drift at E284 – Roof to Floor

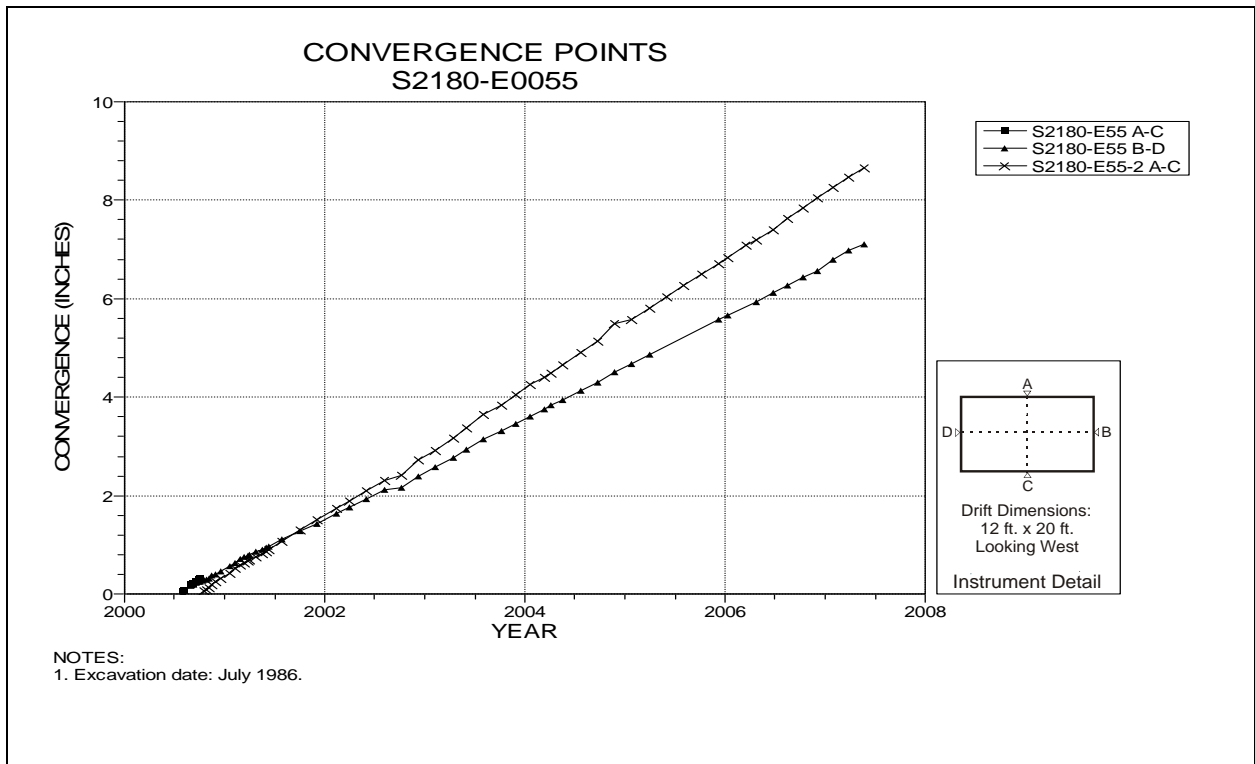


Figure 4-238 Convergence Point Array  
S2180 Drift at E55 – All Chords

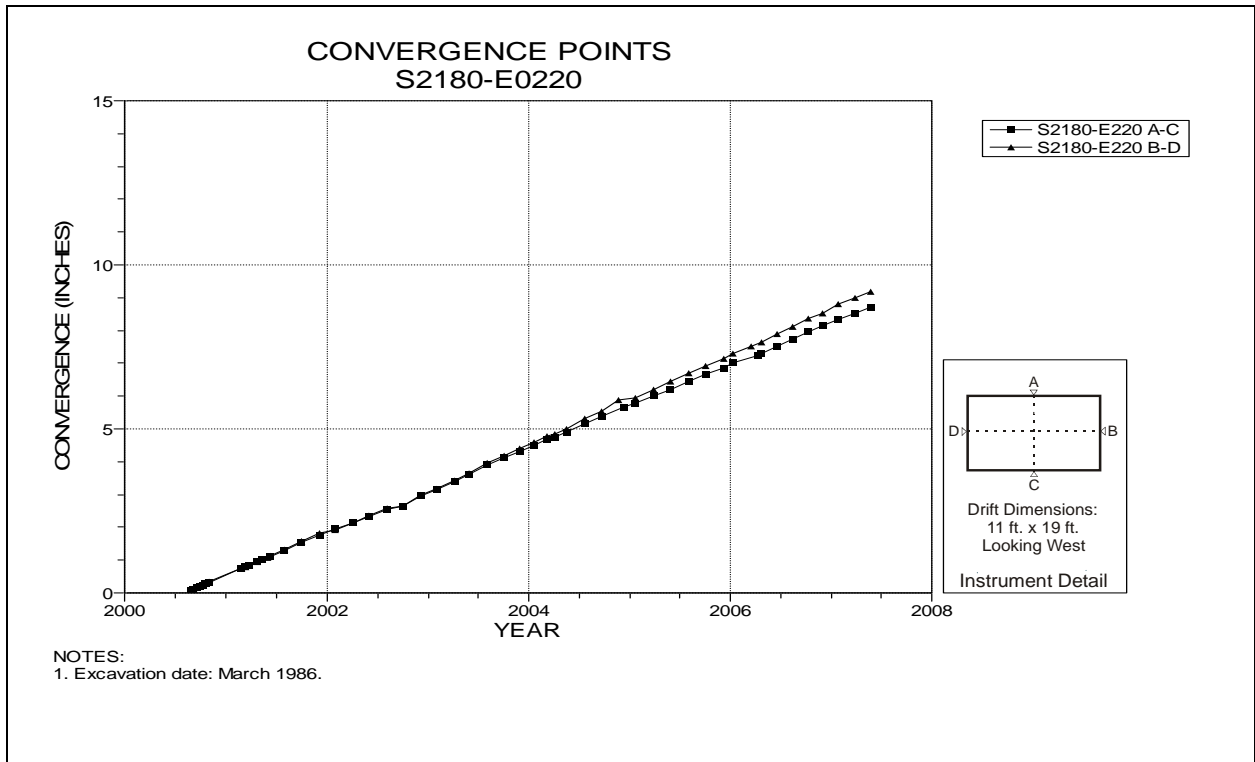


Figure 4-239 Convergence Point Array  
S2180 Drift at E220 – All Chords

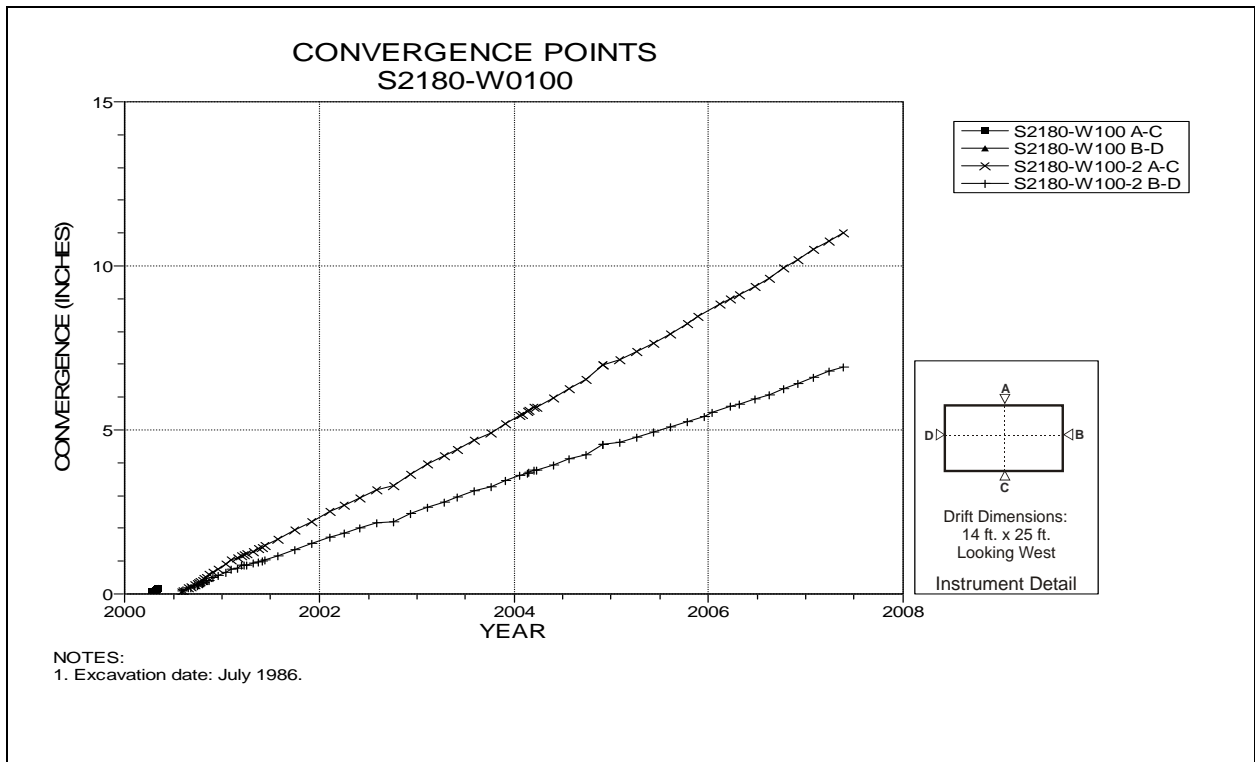


Figure 4-240 Convergence Point Array  
S2180 Drift at W100 – All Chords

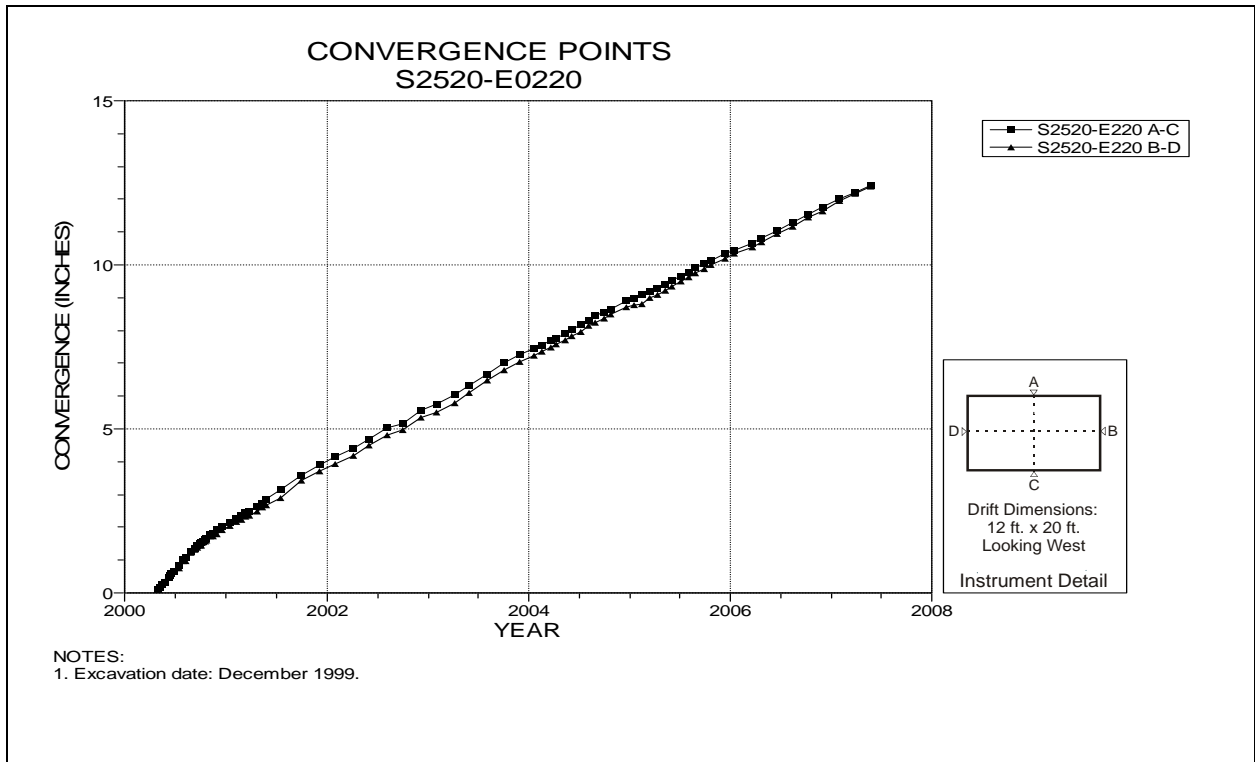


Figure 4-241 Convergence Point Array  
S2520 Drift at E220 – All Chords

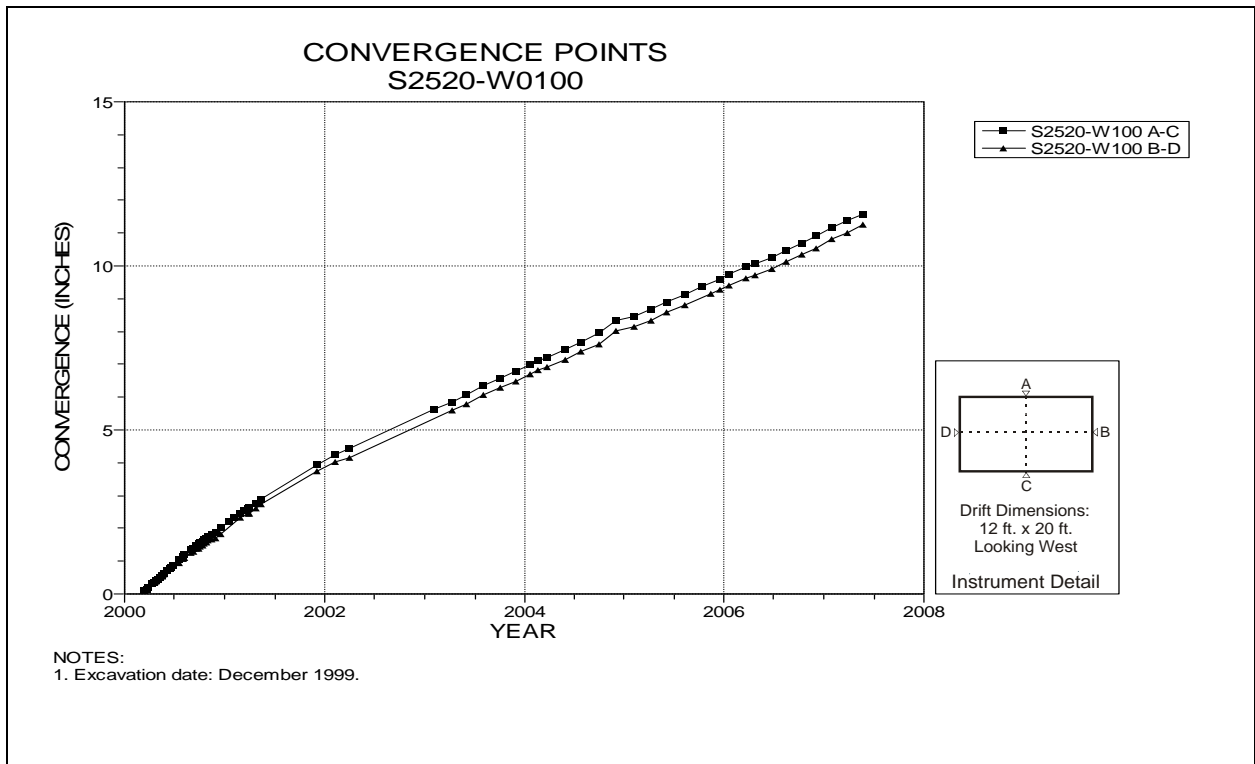


Figure 4-242 Convergence Point Array  
S2520 Drift at W100 – All Chords

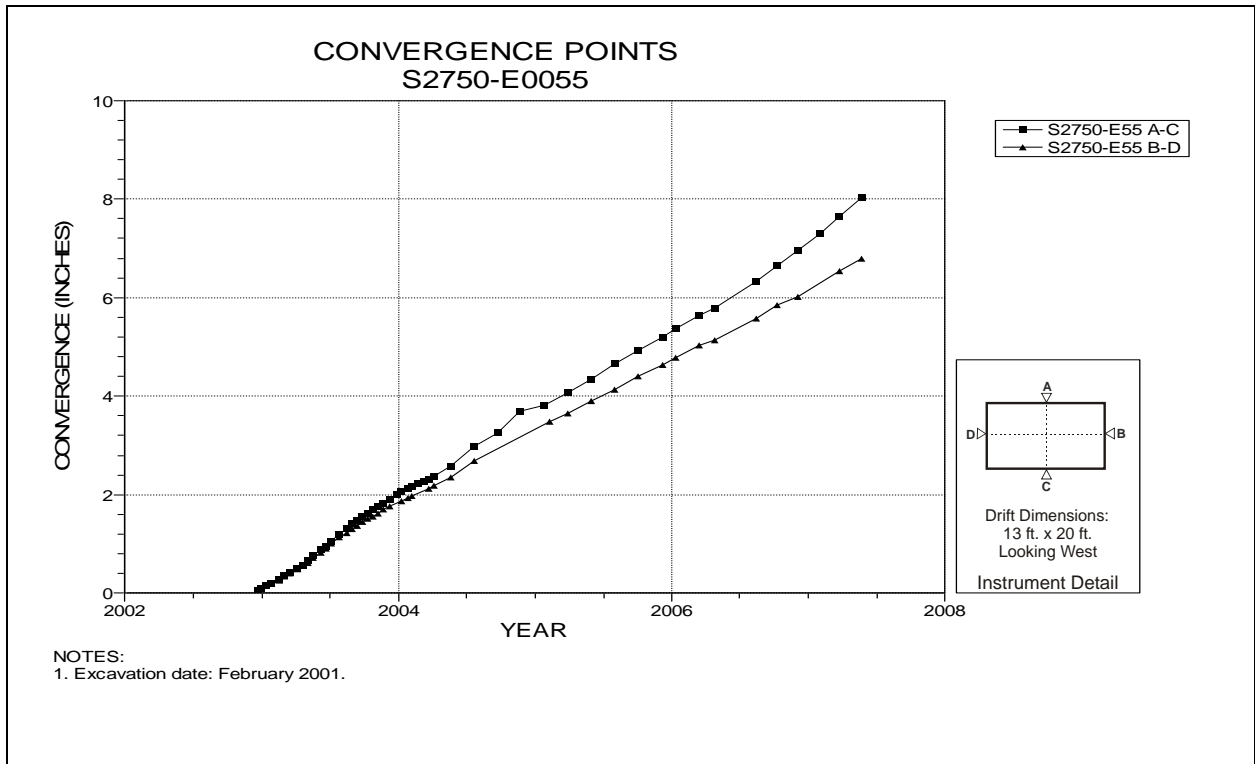


Figure 4-243 Convergence Point Array  
S2750 Drift at E55 – All Chords

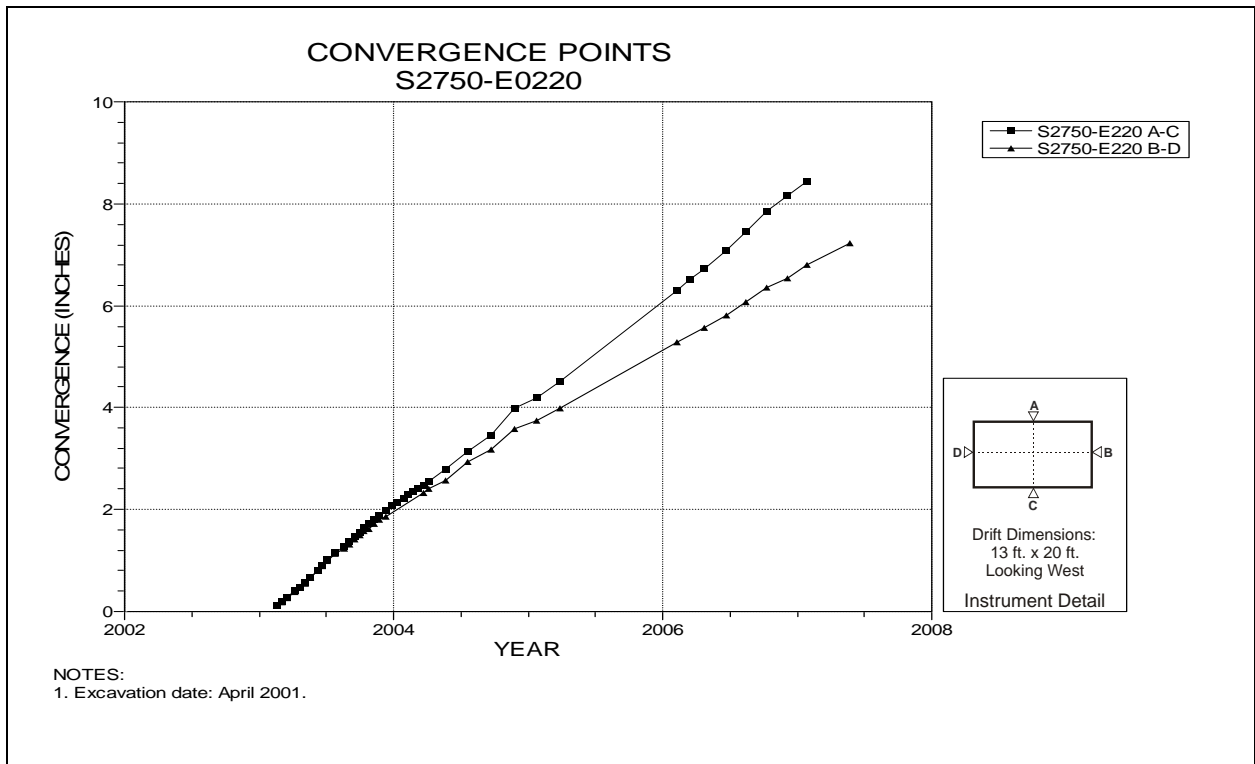


Figure 4-244 Convergence Point Array  
S2750 Drift at E220 – All Chords

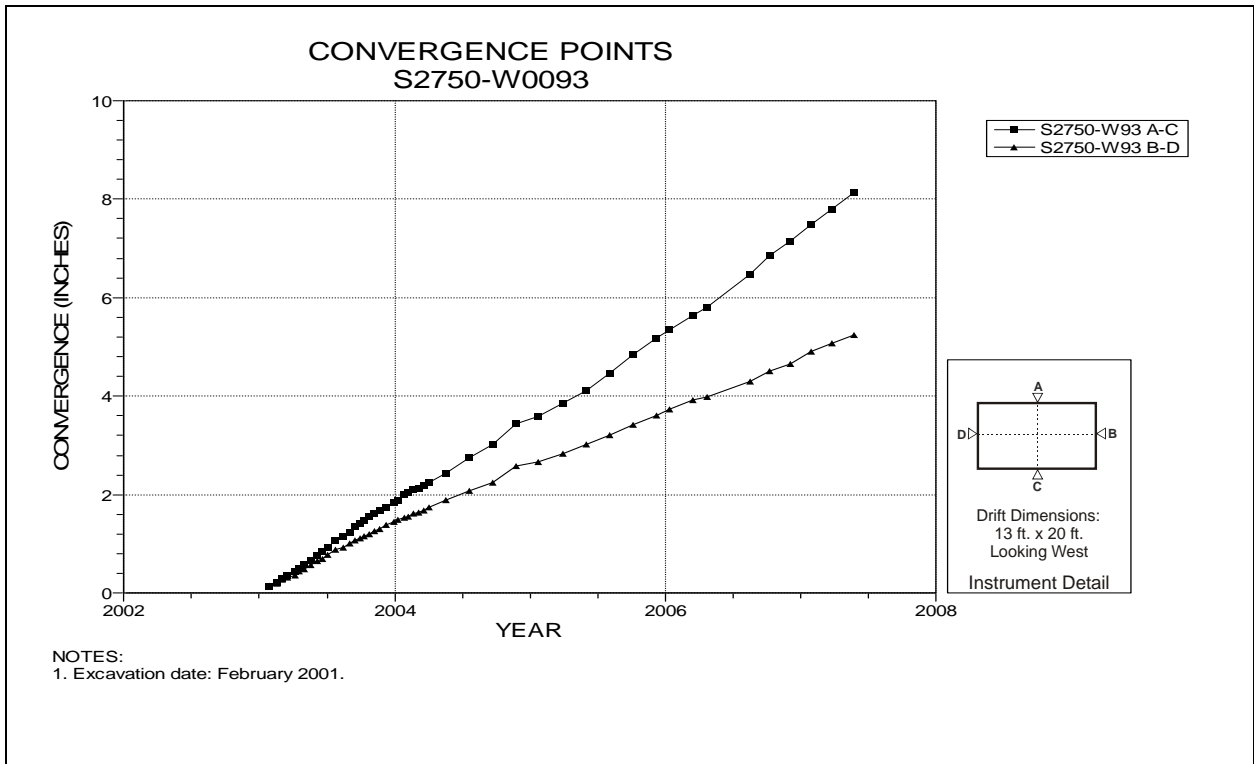


Figure 4-245 Convergence Point Array  
S2750 Drift at W93 – All Chords

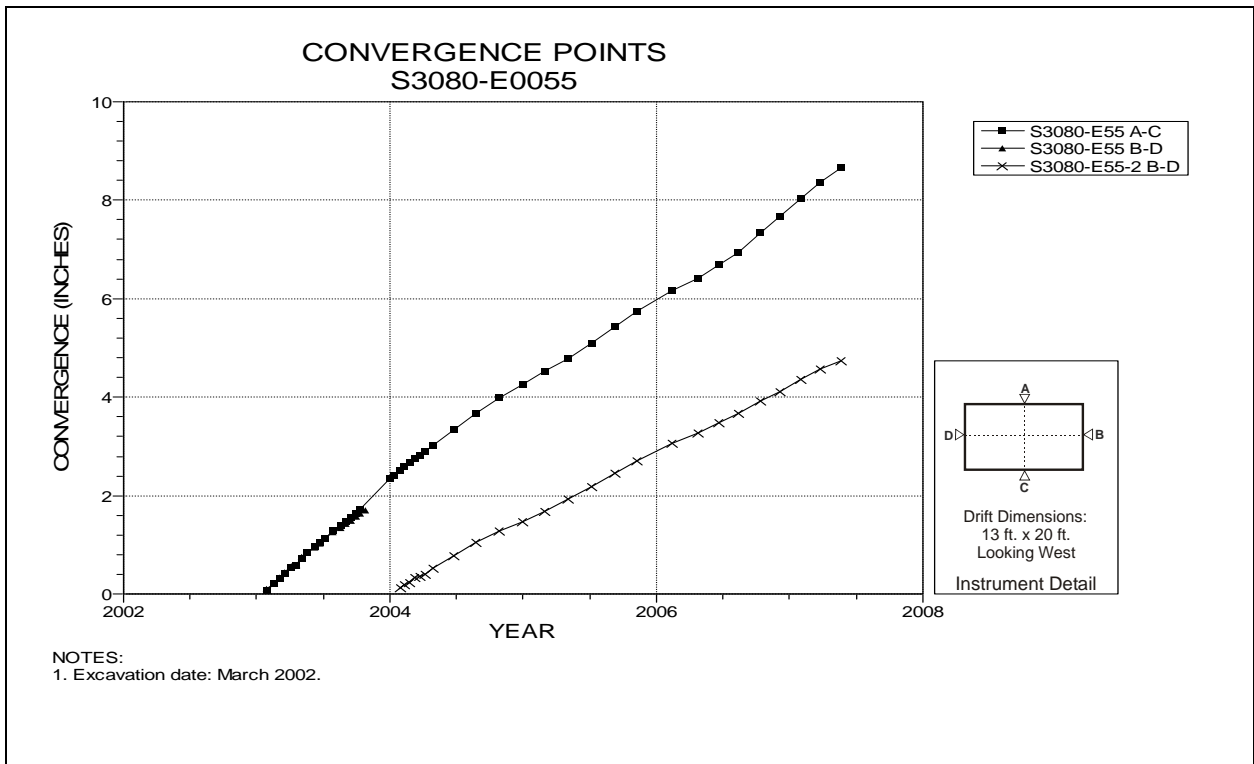


Figure 4-246 Convergence Point Array  
S3080 Drift at E55 – All Chords

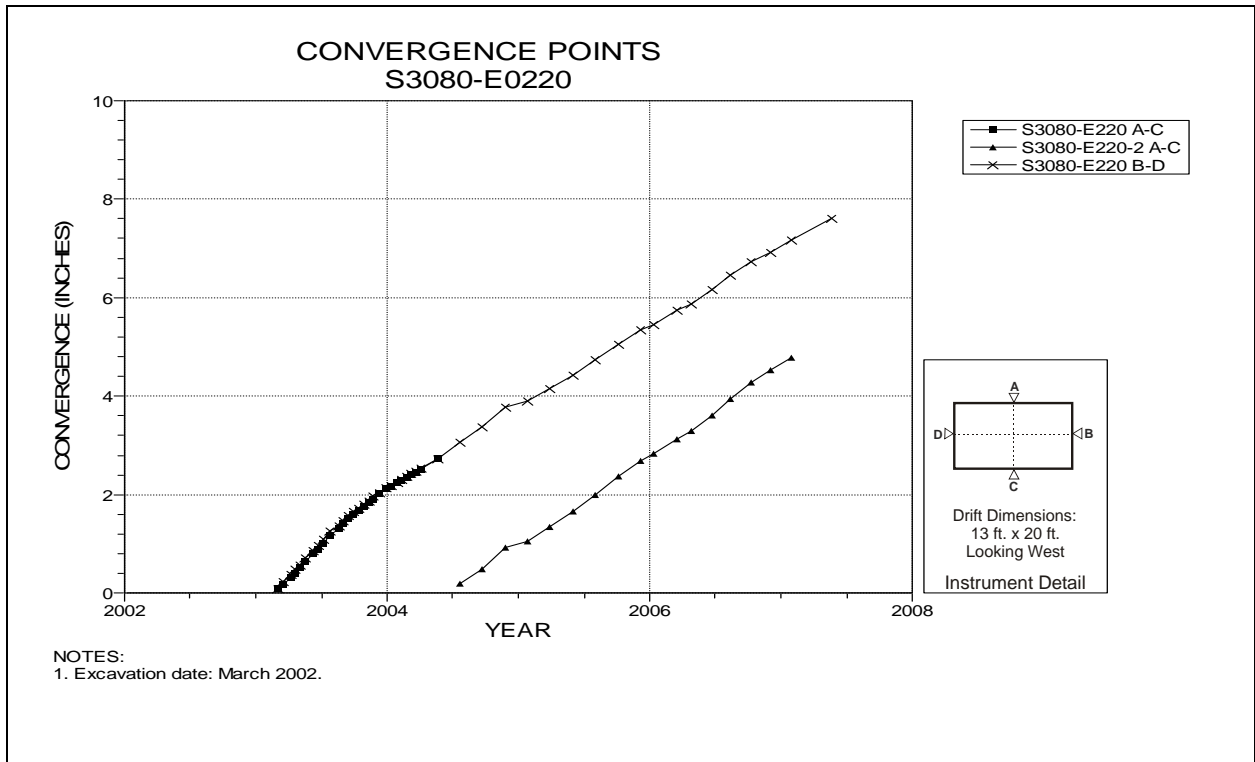


Figure 4-247 Convergence Point Array  
S3080 Drift at E220 – All Chords

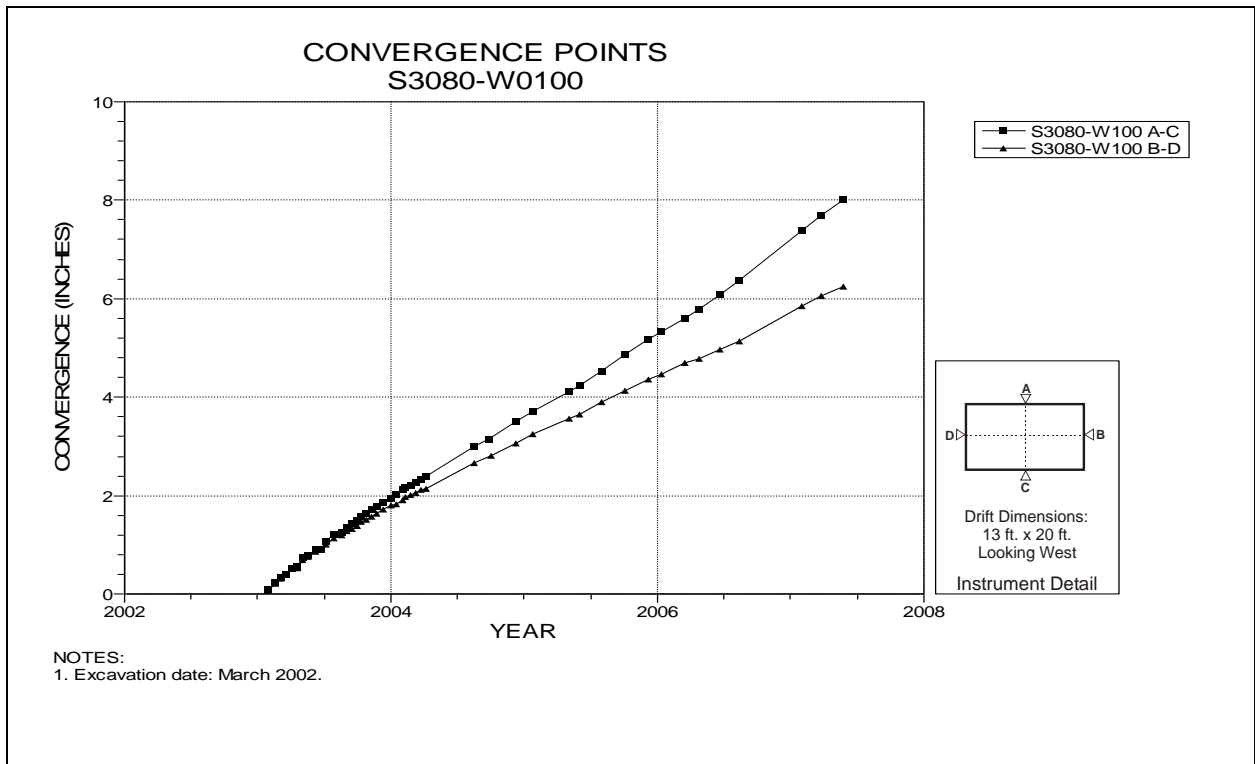


Figure 4-248 Convergence Point Array  
S3080 Drift at W100 – All Chords



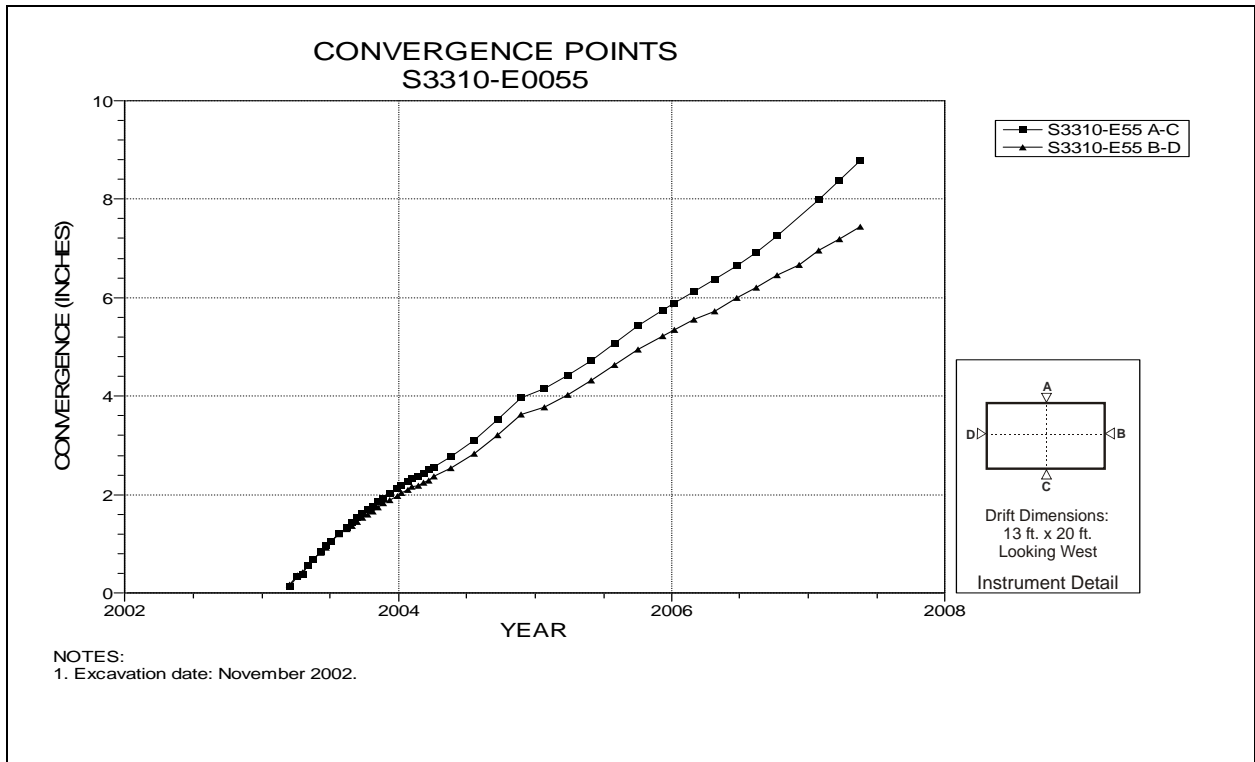


Figure 4-249 Convergence Point Array  
S3310 Drift at E55 – All Chords

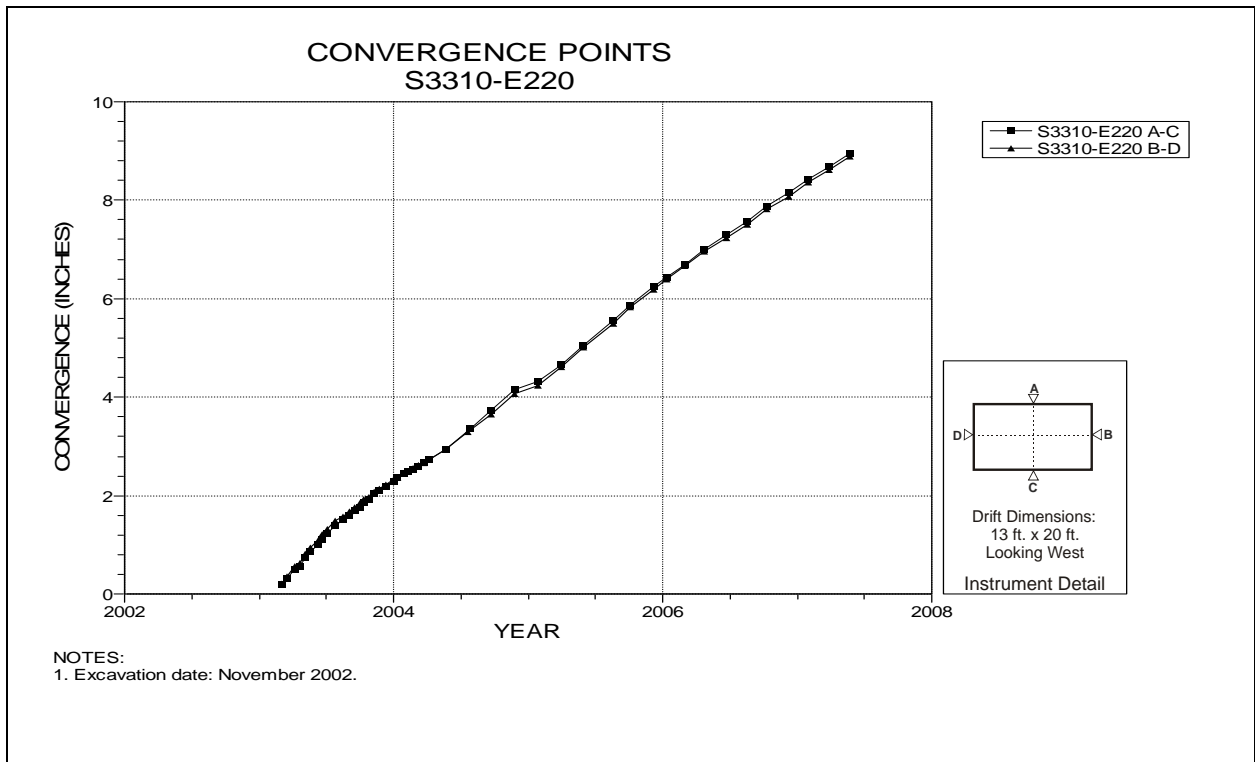


Figure 4-250 Convergence Point Array  
S3310 Drift at E220 – All Chords

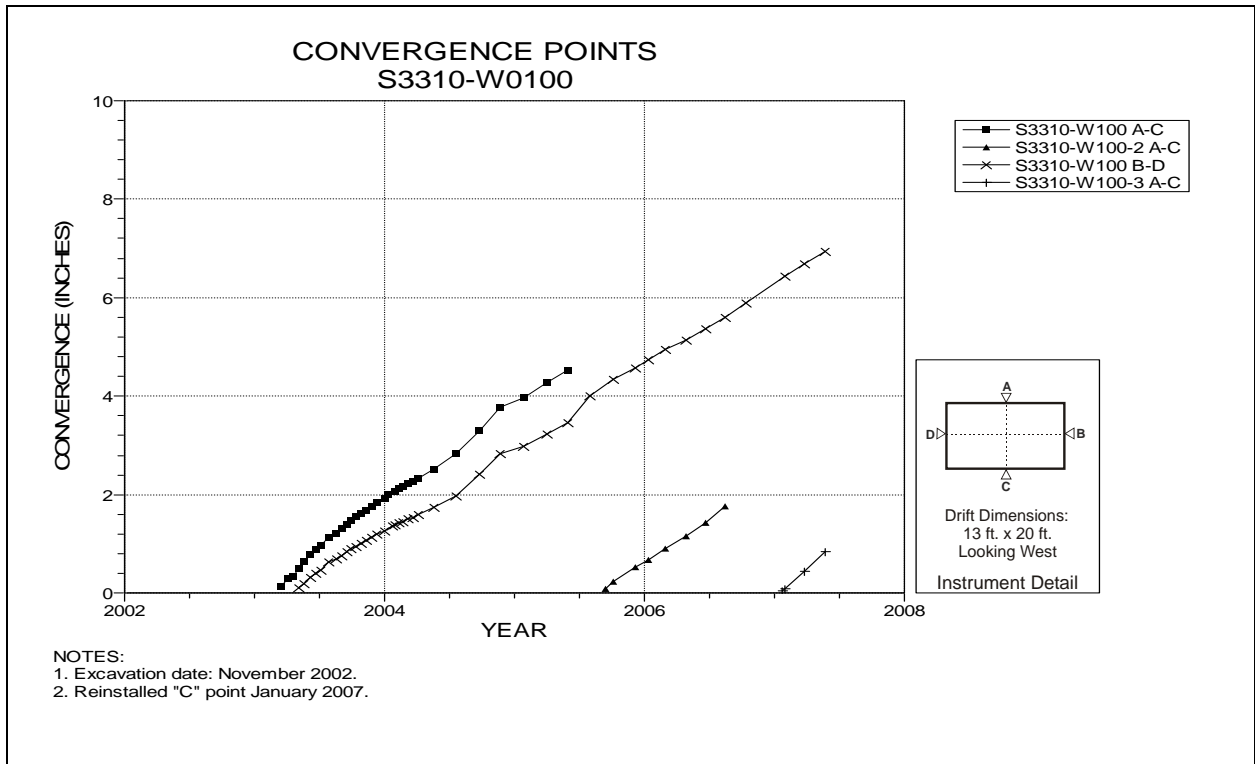


Figure 4-251 Convergence Point Array  
S3310 Drift at W100 – All Chords

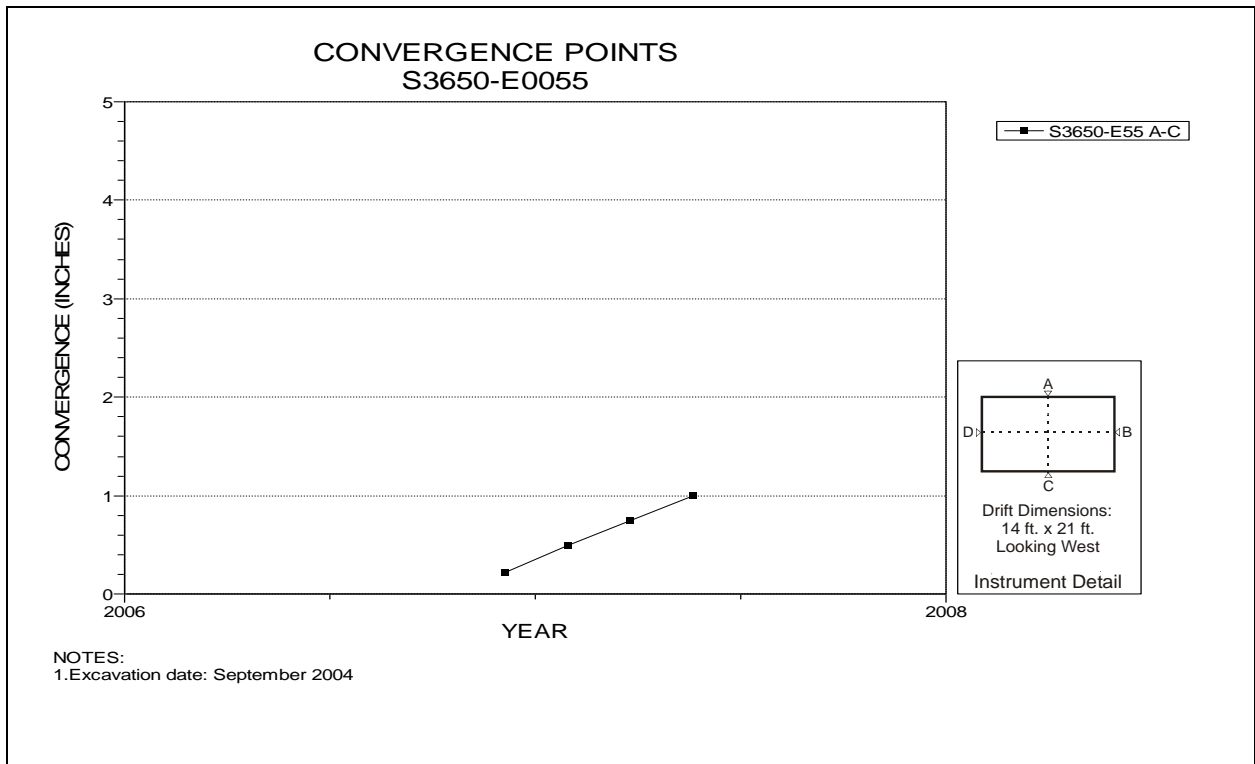


Figure 4-252 Convergence Point Array  
S3650 Drift at E55 – Roof to Floor

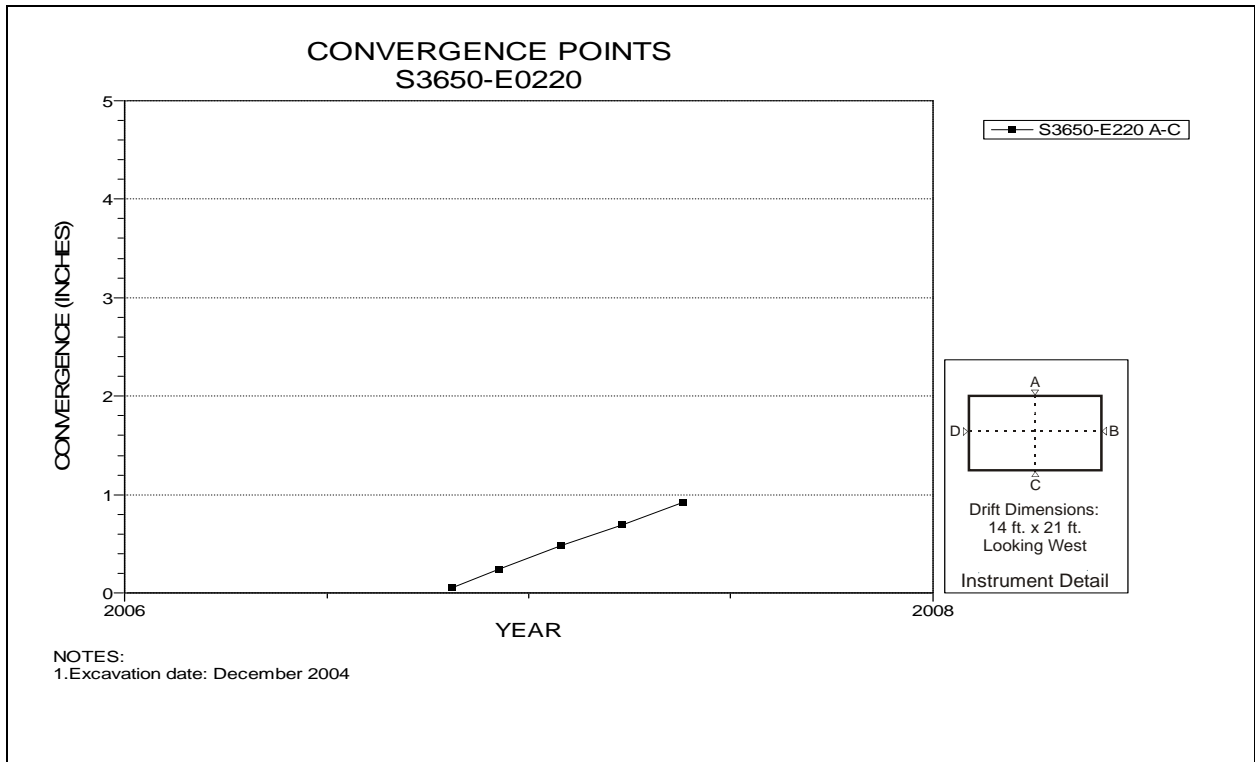


Figure 4-253 Convergence Point Array  
S3650 Drift at E220 – Roof to Floor

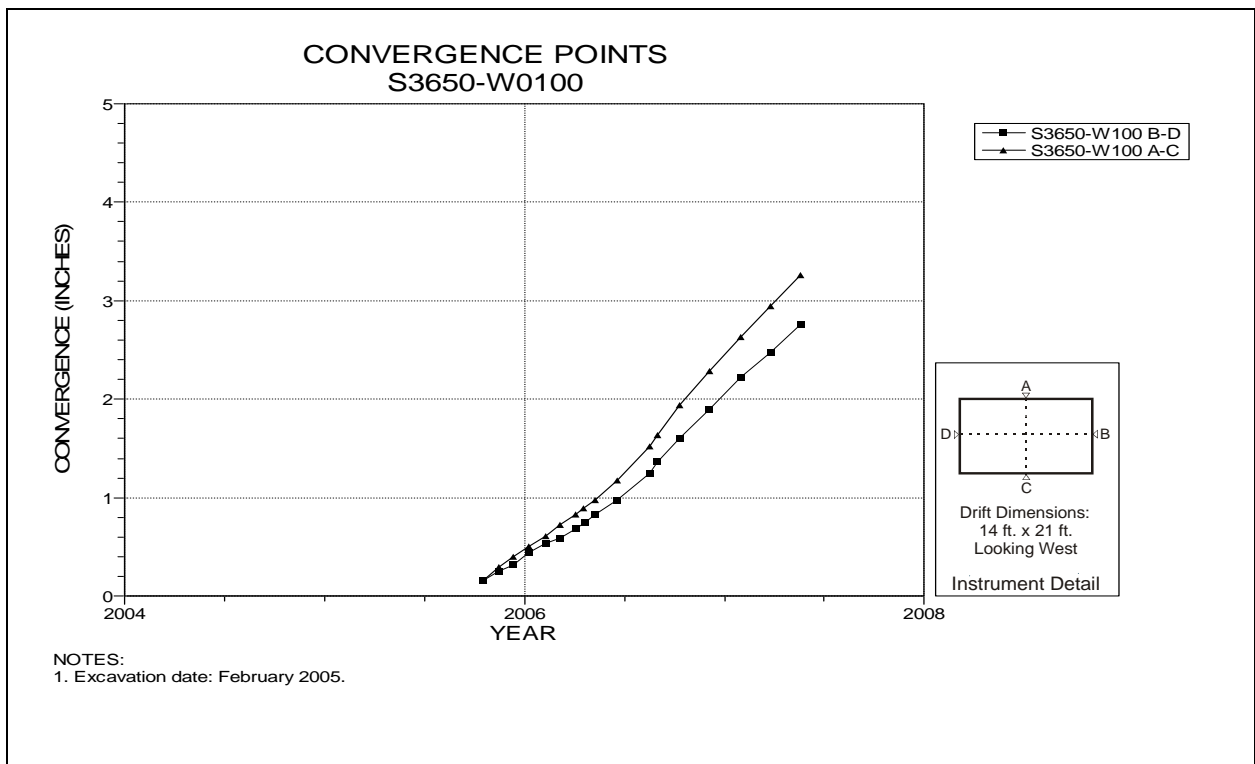


Figure 4-254 Convergence Point Array  
S3650 Drift at W100 – All Chords

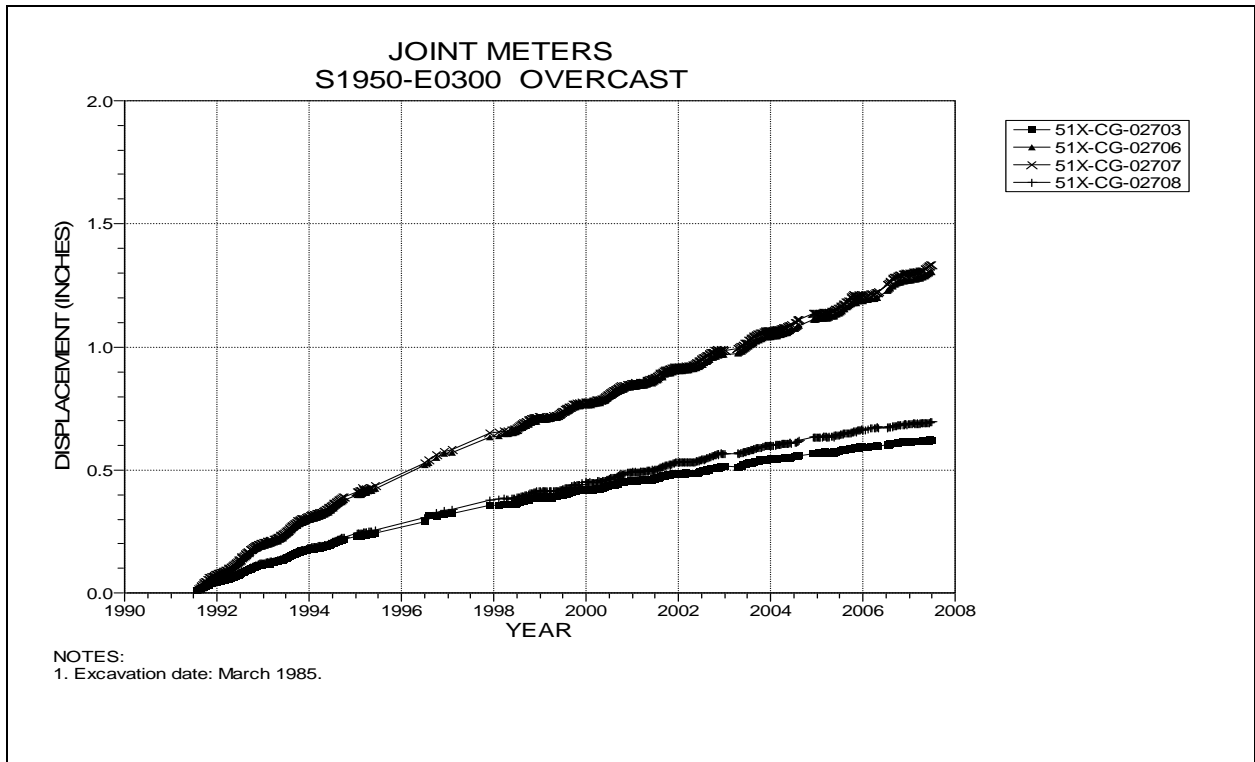


Figure 4-255 Joint Meters  
S1950 Drift at E300 – Drift Overcast

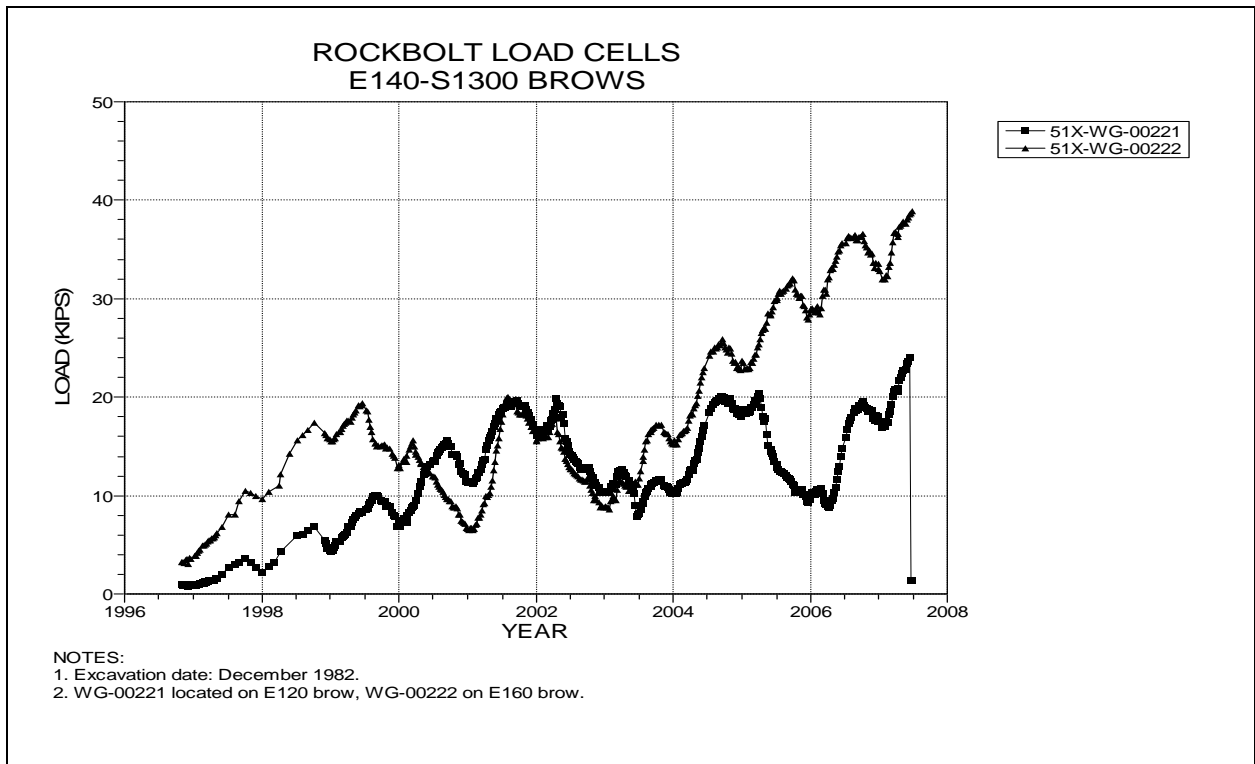


Figure 4-256 Rock Bolt Load Cells  
E140 Drift at S1300 Brows

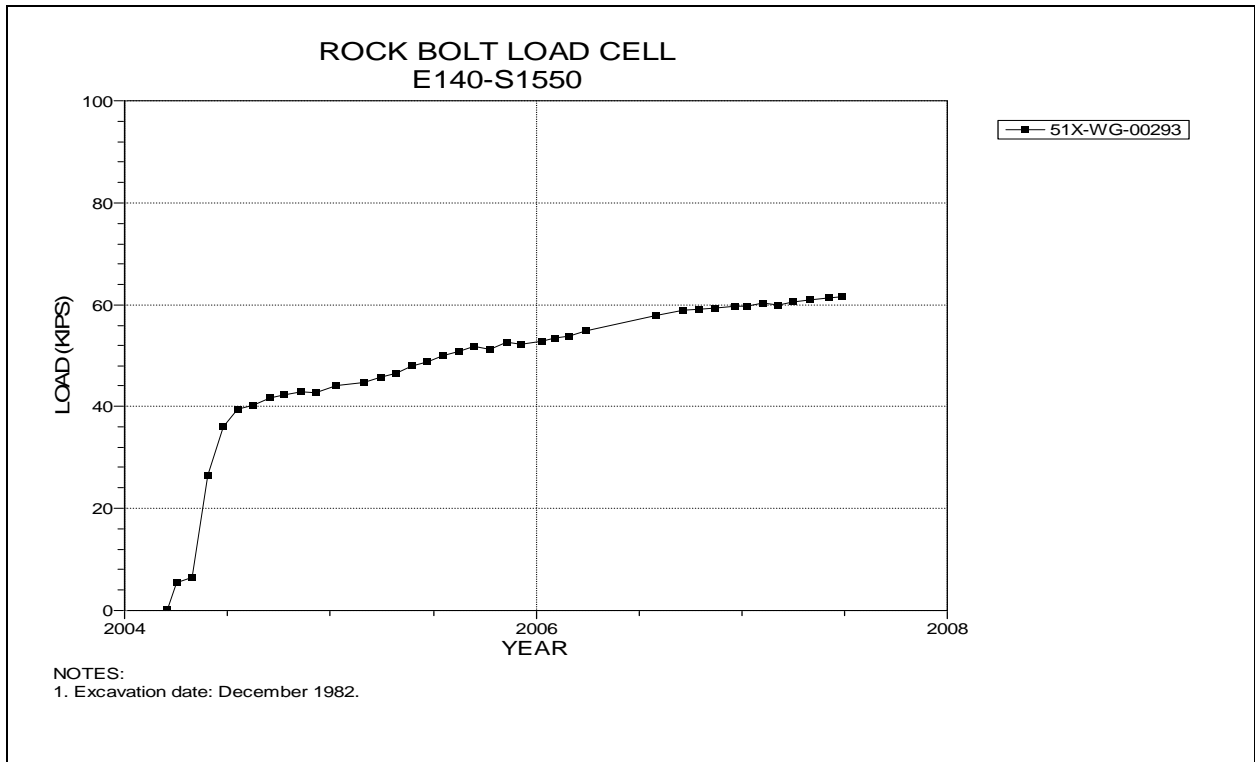


Figure 4-257 Rock Bolt Load Cell  
E140 Drift at S1550

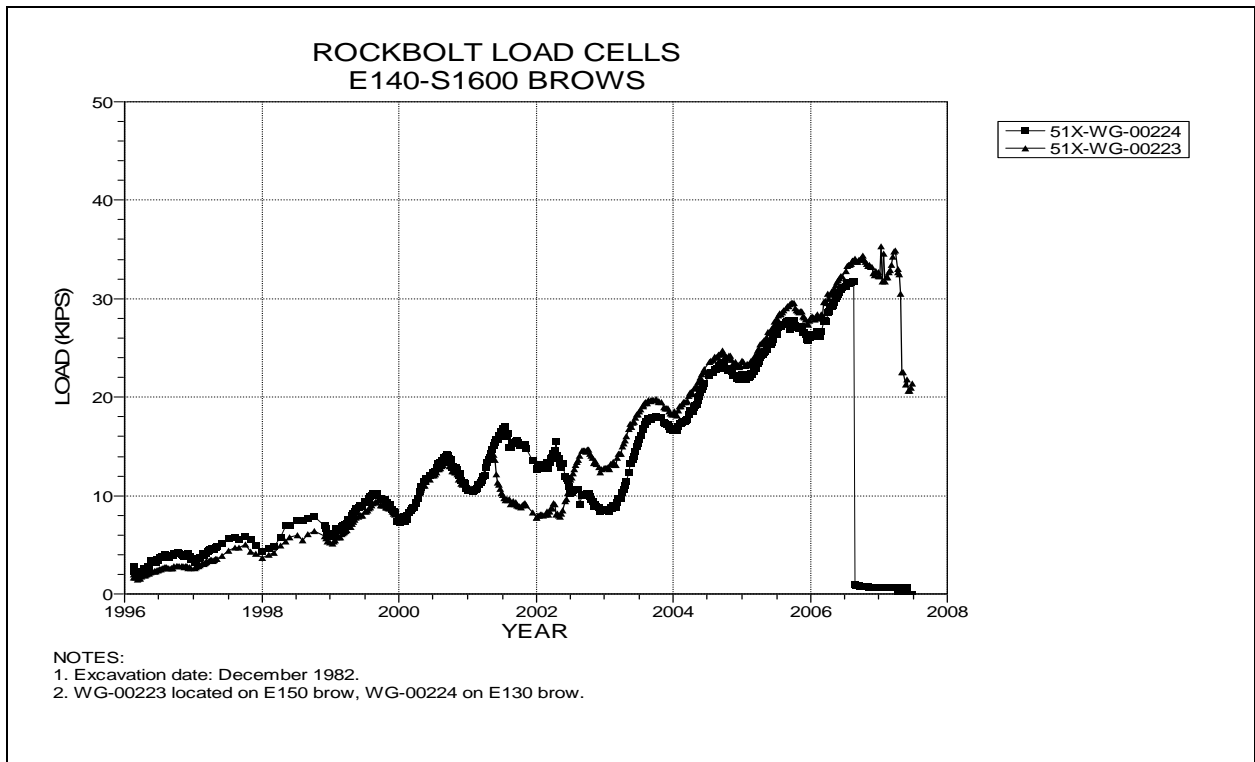


Figure 4-258 Rock Bolt Load Cells  
E140 Drift at S1600 Brows

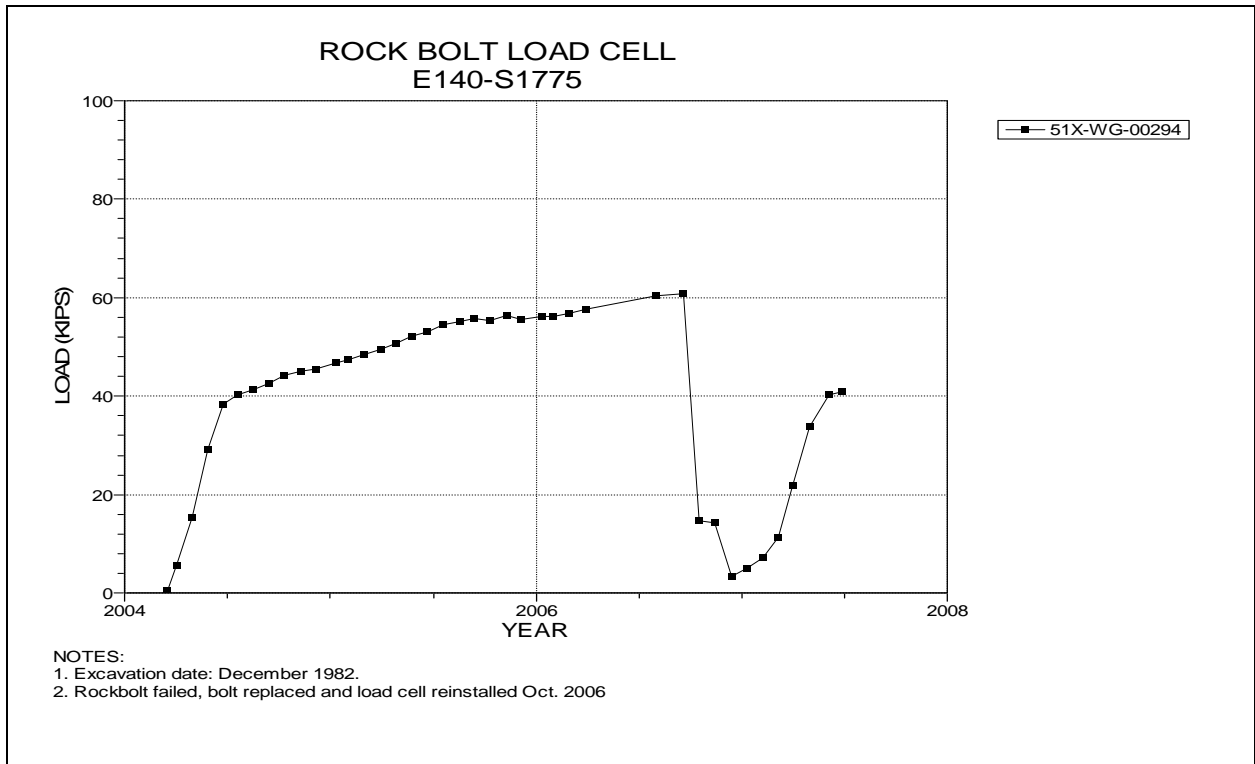


Figure 4-259 Rock Bolt Load Cell  
E140 Drift at S1775

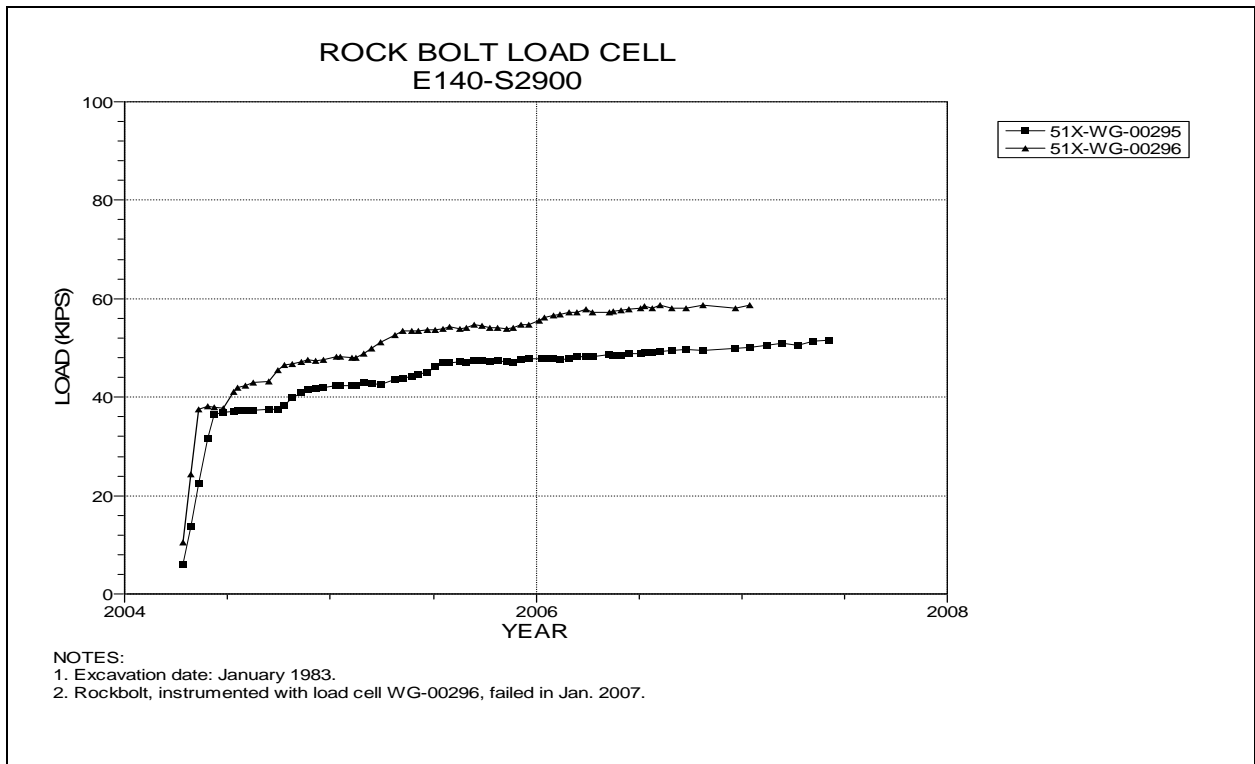


Figure 4-260 Rock Bolt Load Cells  
E140 Drift at S2900

This page is intentionally blank.

## ***5.0 Instrumentation Summary for the Waste Disposal Area***

---

This chapter presents a summary of the data collected from instruments located in the Waste Disposal Area at the WIPP. Table 5-1 presents data and analysis of the access drifts associated with Panel 1. Plots of the instrument data are presented as Figures 5-1 through 5-15.

Table 5-2 presents data and analysis of the access drifts associated with Panel 2. Plots of the instrument data are presented as Figures 5-16 and 5-17.

During the reporting period CH waste was emplaced in Rooms 1-3 of Panel 3. Remote monitoring continued from instrumentation tied into the Geotechnical Instrumentation System throughout the reporting period. Manually read instrumentation data were collected and are reported for areas not blocked by emplaced waste. Panel data and analysis are presented on Table 5-3. Plots of the instrument data are presented as Figures 5-18 through 5-45.

Table 5-4 presents data and analysis of Panel 4. Plots of the instrument data are presented as Figures 5-46 through 5-115.

The excavation of Panel 5 commenced in July 2006. Instruments were installed in Panel 5 as mining progressed. Table 5-5 presents data and analysis of Panel 5. Plots of the instrument data are presented as Figures 5-116 through 5-150.



**Table 5-1  
Panel 1 Access Drifts Data Analysis**

**CONVERGENCE POINTS**

Field Tag	Location	Figure Number	Last Reading 2006 to 2007		Cumulative Displacement (inches)	Closure Rate 2006 to 2007 (in/year)	Closure Rate 2005 to 2006 (in/year)	Rate Change Percent	Comments
			Date	Inches					
S1600-E311-2 A-C	S1600 DRIFT-E311	5-1	05/25/07	12.781	18.228	0.83	0.81	2%	
S1600-E311-5 B-D	S1600 DRIFT-E311	5-1	05/25/07	7.452	16.695	0.91	0.78	17%	
S1600-E332-3 A-C	S1600 DRIFT-E332	5-2	05/25/07	11.878	16.305	0.95	0.83	14%	
S1600-E357-2 A-C	S1600 DRIFT-E357	5-3	05/25/07	13.718	19.116	1.10	0.97	13%	
S1600-E382-2 A-C	S1600 DRIFT-E382	5-4	05/25/07	13.724	19.104	1.06	0.94	13%	
S1600-E407-2 A-G	S1600 DRIFT-E407	5-5	05/25/07	14.837	20.279	1.18	1.06	11%	
S1600-E407-2 B-F	S1600 DRIFT-E407	5-5	05/25/07	13.760	18.766	1.17	1.01	16%	
S1600-E407-2 H-L	S1600 DRIFT-E407	5-5	05/25/07	14.483	19.548	1.17	1.04	13%	
S1600-E432-2 A-C	S1600 DRIFT-E432	5-6	05/25/07	16.951	23.710	1.30	1.17	11%	
S1600-E453 A-C	S1600 DRIFT-E453	5-7	05/25/07	2.071	2.071	0.57	0.51	12%	
S1600-E453 B-D	S1600 DRIFT-E453	5-7	05/25/07	1.999	1.999	0.53	0.46	15%	
S1950-E311-6 A-C	S1950 DRIFT-E311	5-8	05/25/07	4.114	26.075	1.15	1.13	2%	
S1950-E311-3 B-D	S1950 DRIFT-E311	5-8	05/25/07	10.672	23.715	1.25	1.19	5%	
S1950-E332-4 A-C	S1950 DRIFT-E332	5-9	05/25/07	12.552	31.211	1.47	1.38	7%	
S1950-E332-4 B-D	S1950 DRIFT-E332	5-9	05/25/07	8.122	26.109	1.42	1.26	13%	
S1950-E357-7 A-C	S1950 DRIFT-E357	5-10	05/25/07	15.717	35.959	1.85	1.73	7%	
S1950-E357-4 B-D	S1950 DRIFT-E357	5-10	05/25/07	8.790	27.290	1.51	1.40	8%	
S1950-E382-5 A-C	S1950 DRIFT-E382	5-11	05/25/07	18.562	37.247	2.14	1.92	11%	
S1950-E382-3 B-D	S1950 DRIFT-E382	5-11	05/25/07	15.087	29.469	1.57	1.48	6%	
S1950-E407-4 A-G	S1950 DRIFT-E407	5-12	05/25/07	18.400	40.276	2.19	2.13	3%	
S1950-E407-3 H-L	S1950 DRIFT-E407	5-12	05/25/07	19.105	39.862	1.75	1.83	-4%	
S1950-E407-3 D-J	S1950 DRIFT-E407	5-13	05/25/07	15.968	30.145	1.66	1.52	9%	
S1950-E432-3 A-C	S1950 DRIFT-E432	5-14	05/25/07	18.587	40.408	2.07	2.05	1%	
S1950-E432-3 B-D	S1950 DRIFT-E432	5-14	05/25/07	15.070	29.471	1.53	1.43	7%	
S1950-E457-5 A-C	S1950 DRIFT-E457	5-15	05/25/07	2.978	35.324	0.90	0.75	20%	
S1950-E457-4 B-D	S1950 DRIFT-E457	5-15	05/25/07	11.236	26.528	0.66	0.53	25%	

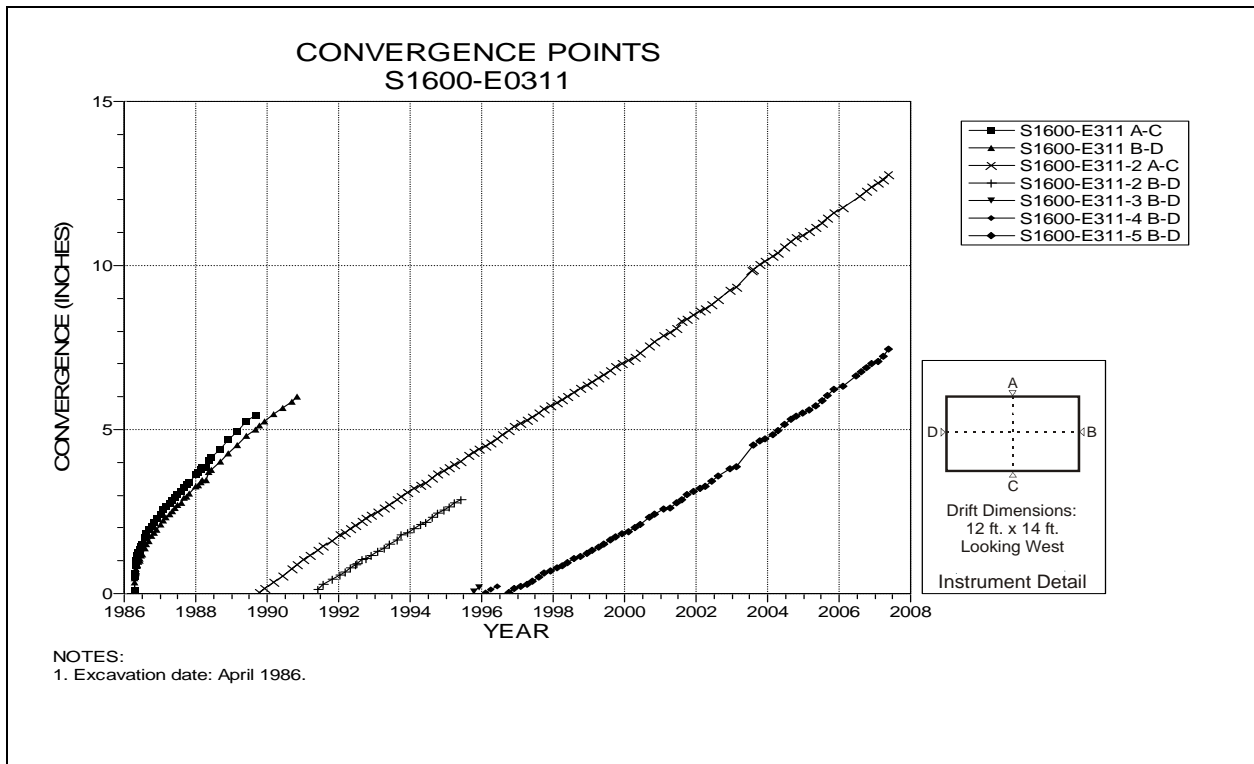


Figure 5-1 Convergence Point Array  
S1600 Drift at E311 – All Chords

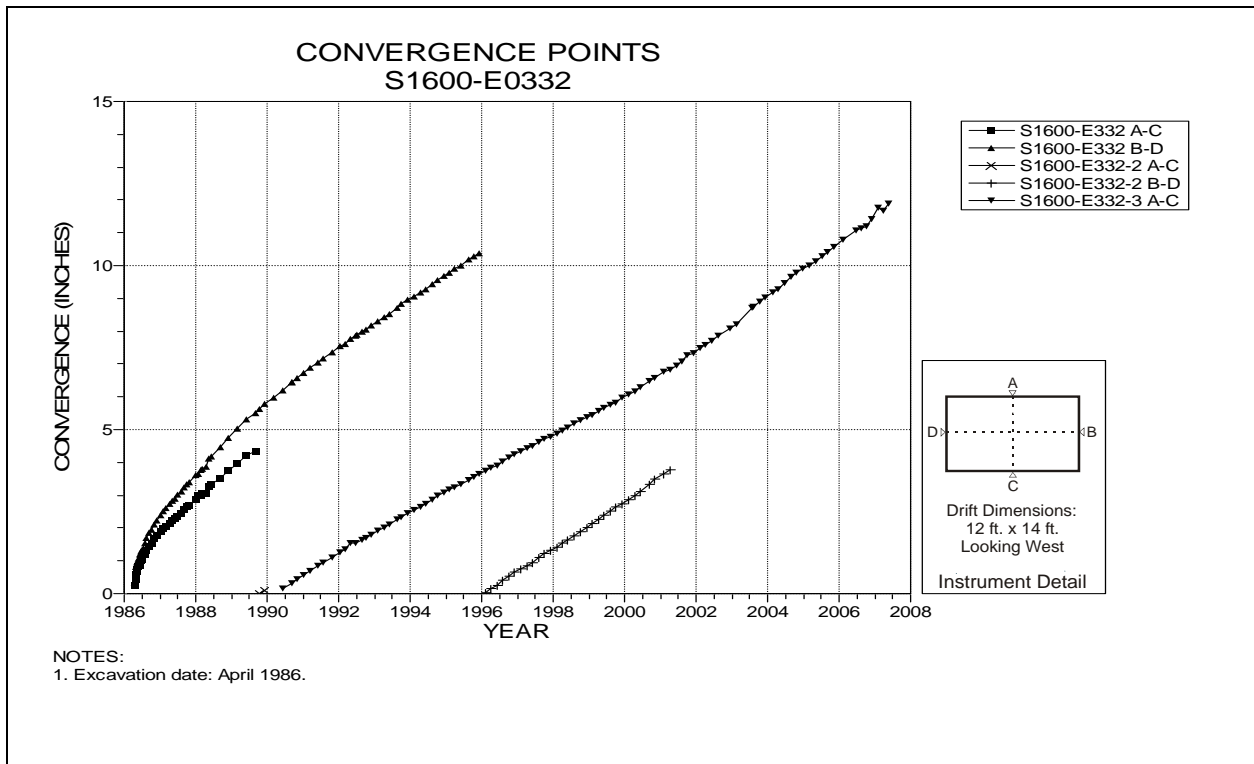


Figure 5-2 Convergence Point Array  
S1600 Drift at E332 – All Chords

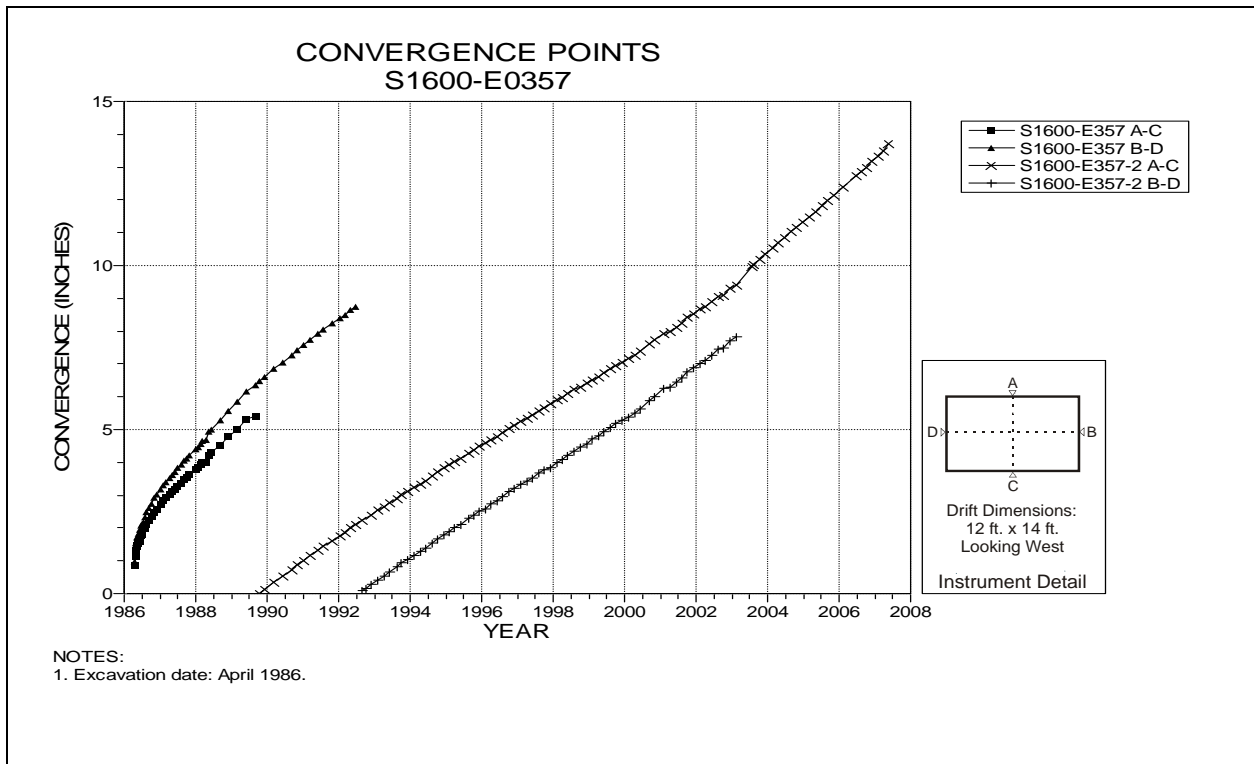


Figure 5-3 Convergence Point Array  
S1600 Drift at E357 – All Chords

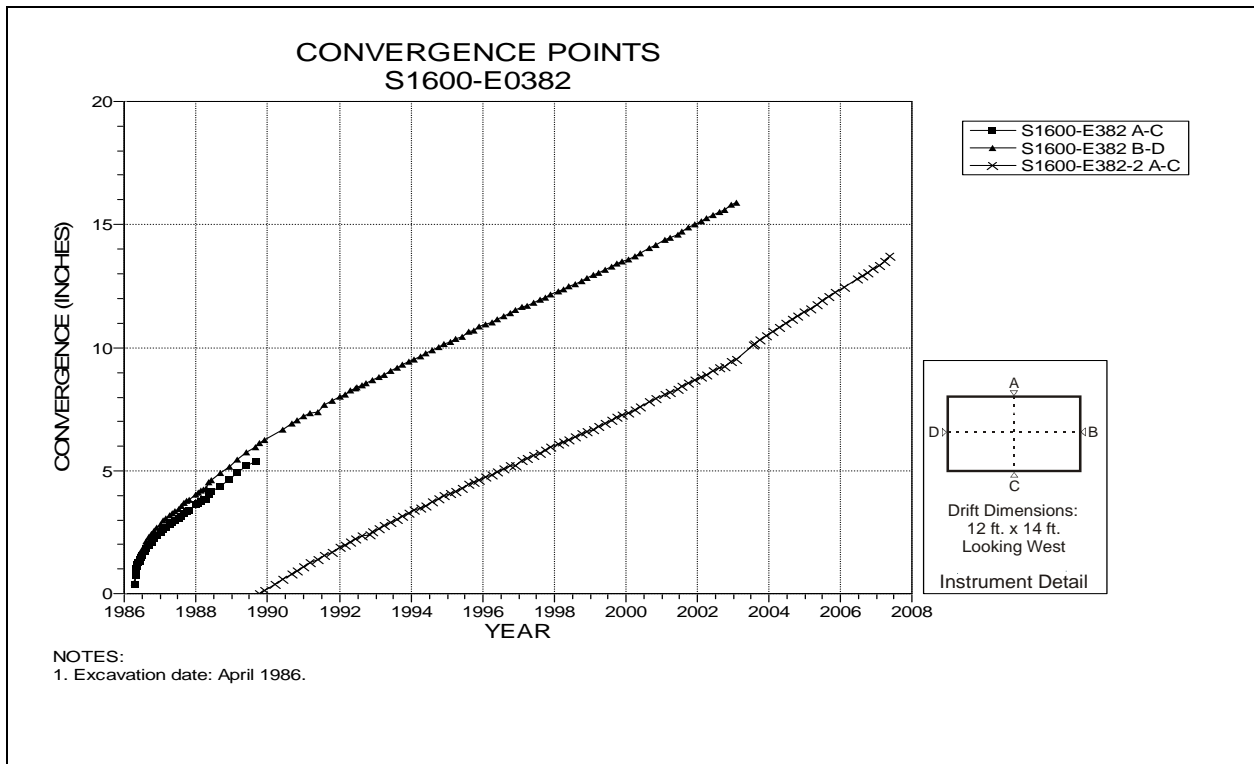


Figure 5-4 Convergence Point Array  
S1600 Drift at E382 – All Chords

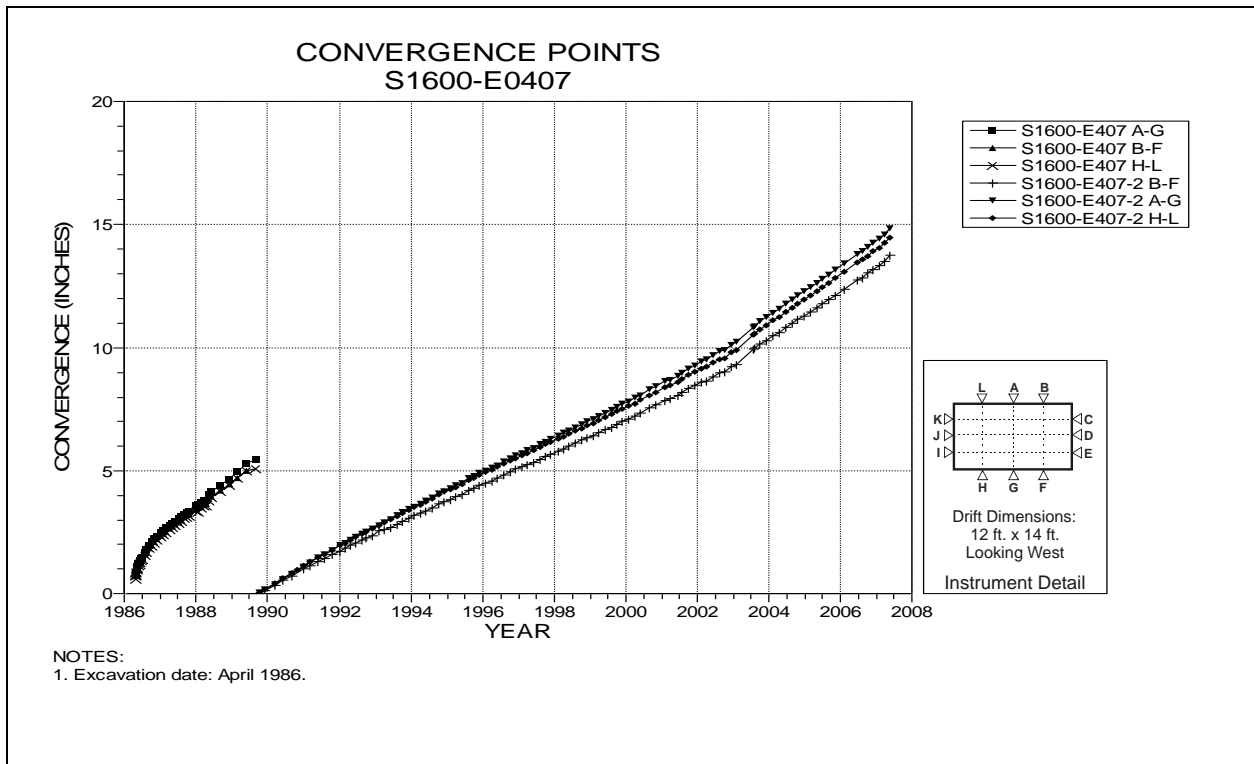


Figure 5-5 Convergence Point Array  
S1600 Drift at E407 – Roof to Floor

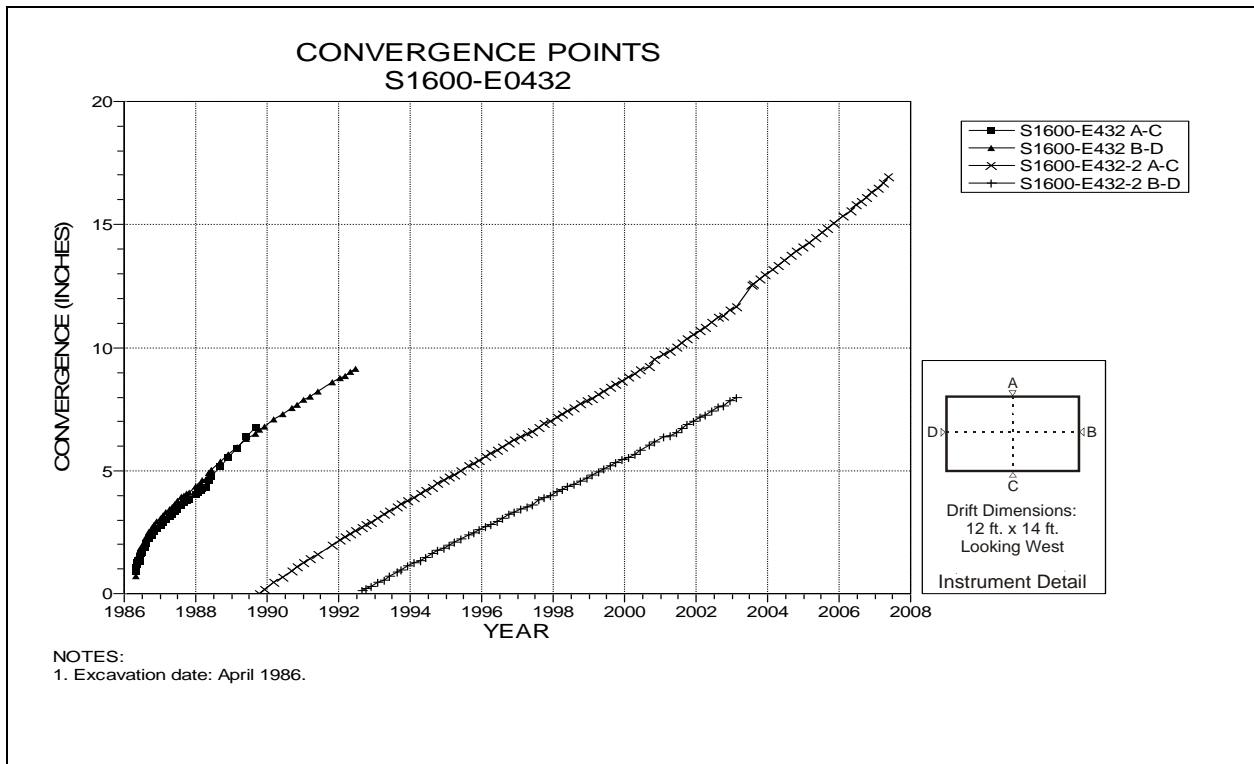


Figure 5-6 Convergence Point Array  
S1600 Drift at E432 – All Chords

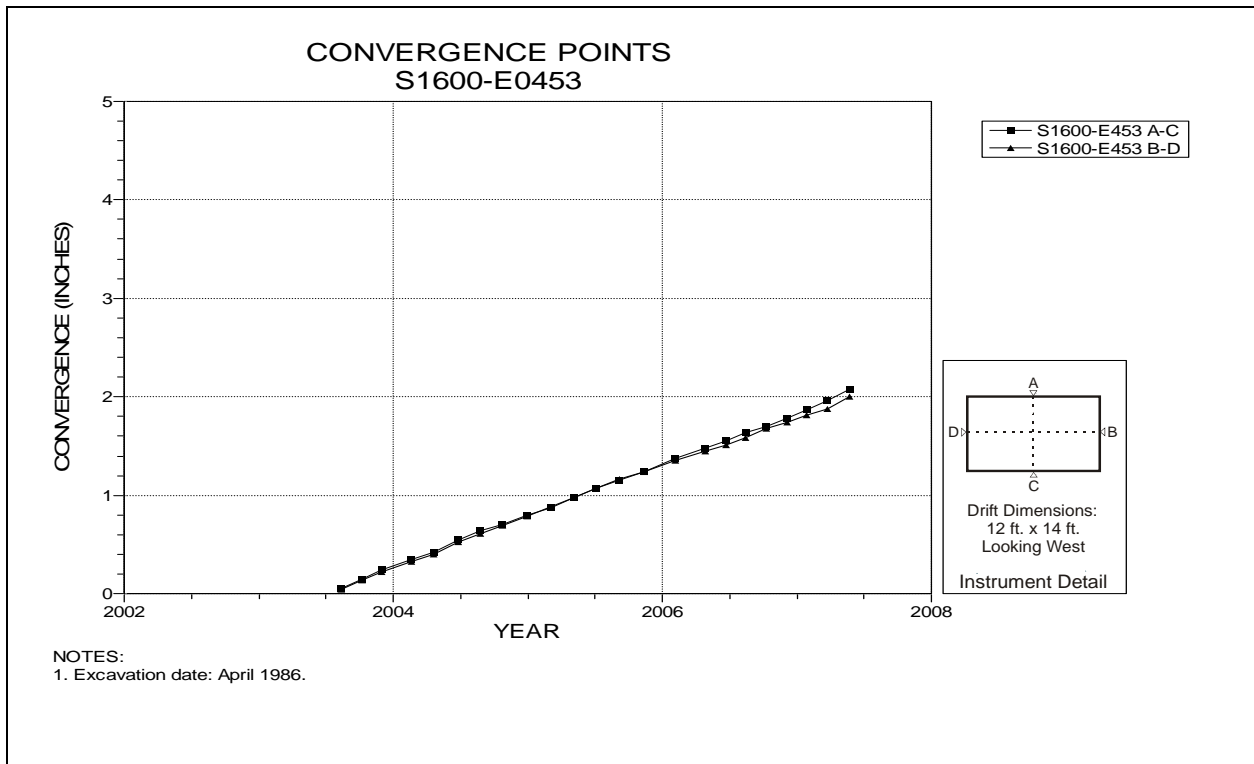


Figure 5-7 Convergence Point Array  
S1600 Drift at E453 – All Chords

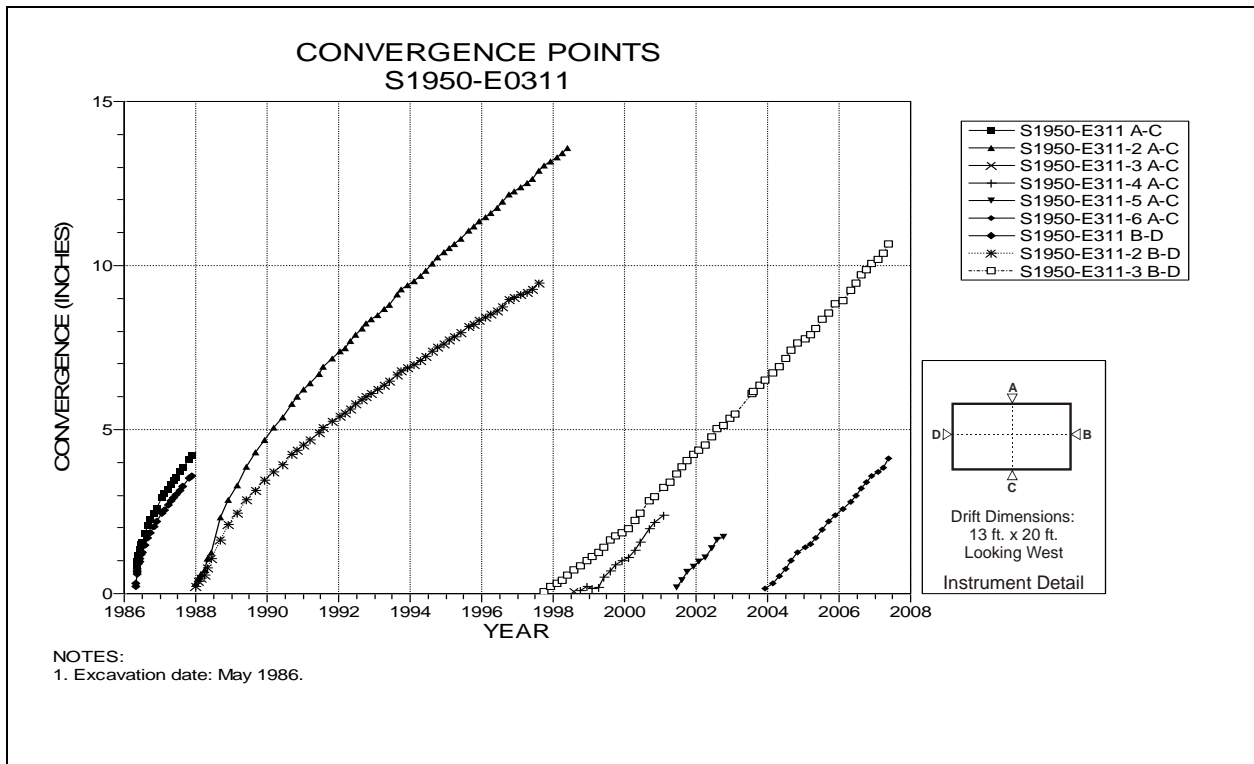


Figure 5-8 Convergence Point Array  
S1950 Drift at E311 – All Chords

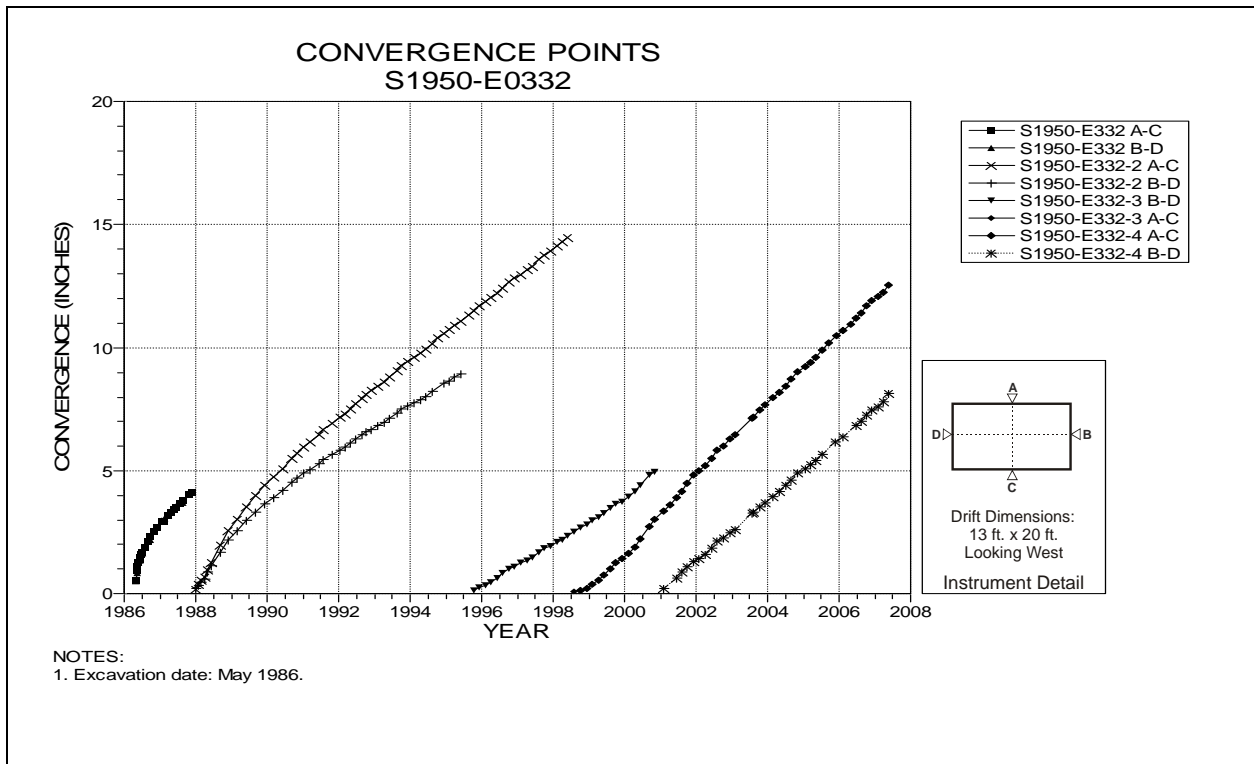


Figure 5-9 Convergence Point Array  
S1950 Drift at E332 – All Chords

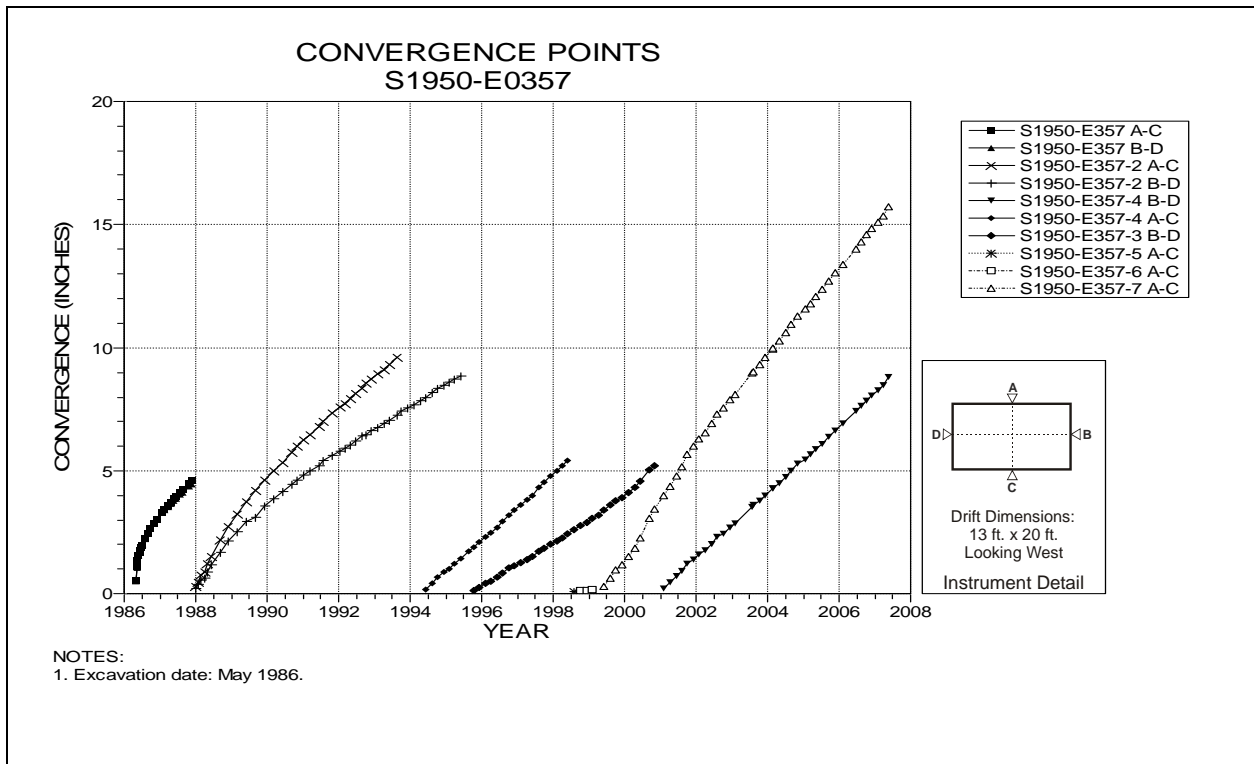


Figure 5-10 Convergence Point Array  
S1950 Drift at E357 – All Chords

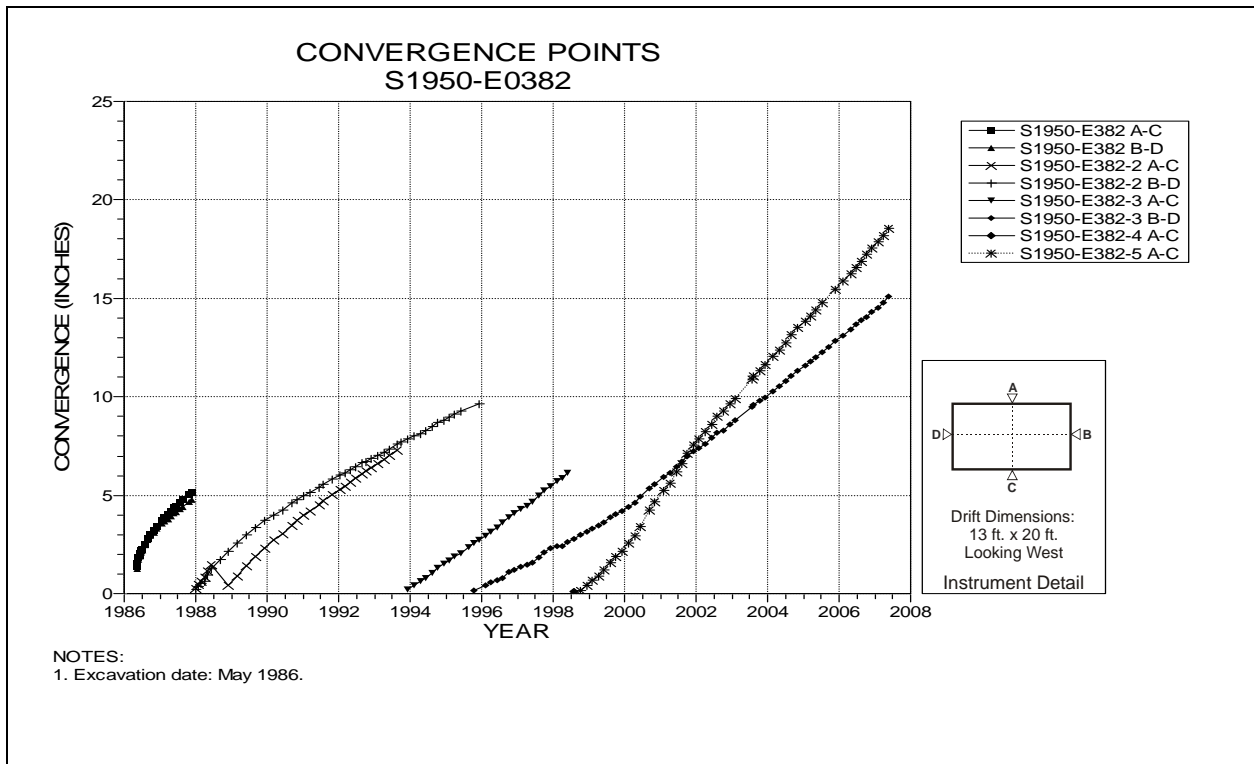


Figure 5-11 Convergence Point Array  
S1950 Drift at E382 – All Chords

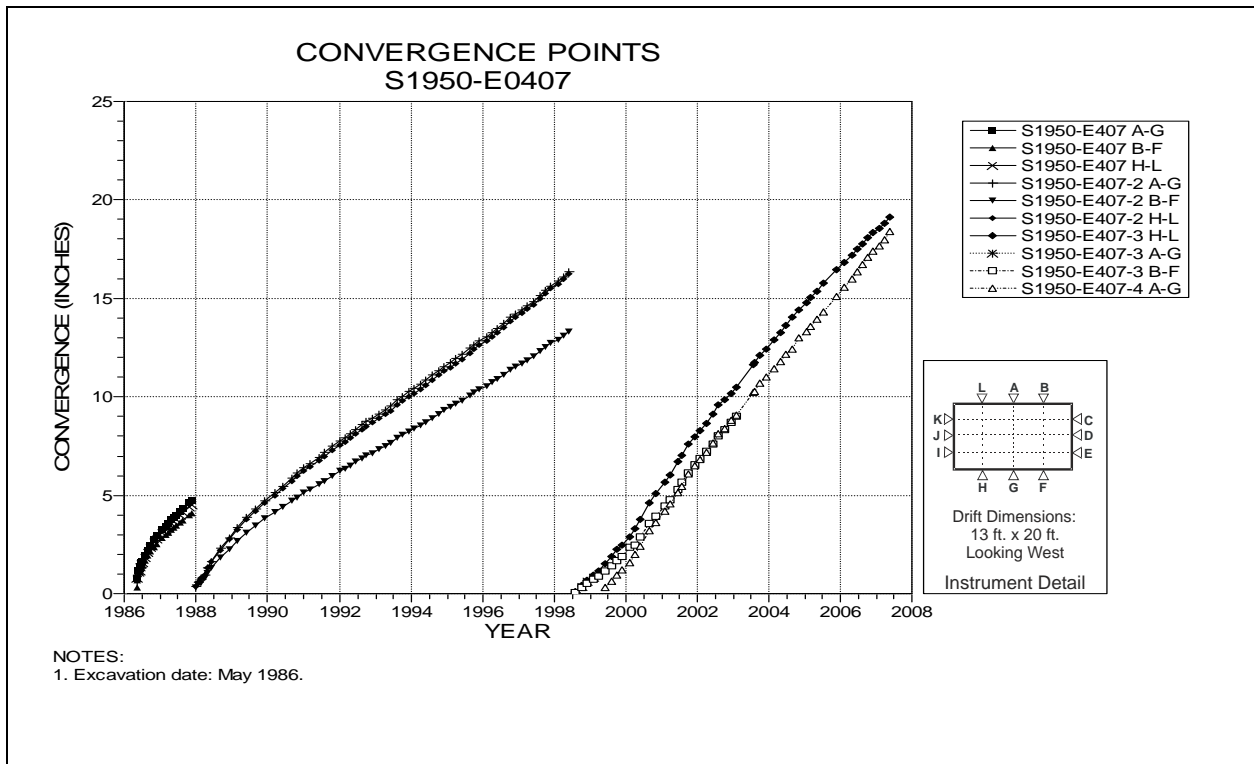


Figure 5-12 Convergence Point Array  
S1950 Drift at E407 – Roof to Floor

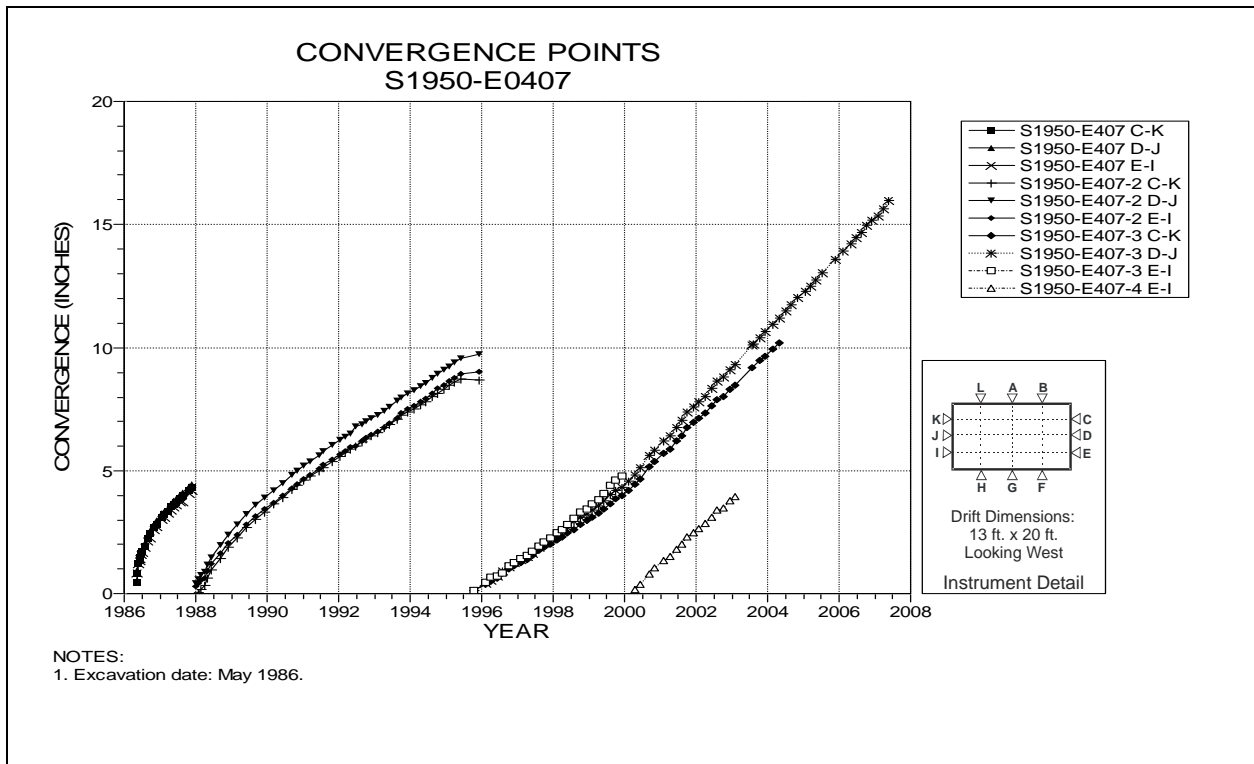


Figure 5-13 Convergence Point Array  
S1950 Drift at E407 – Rib to Rib

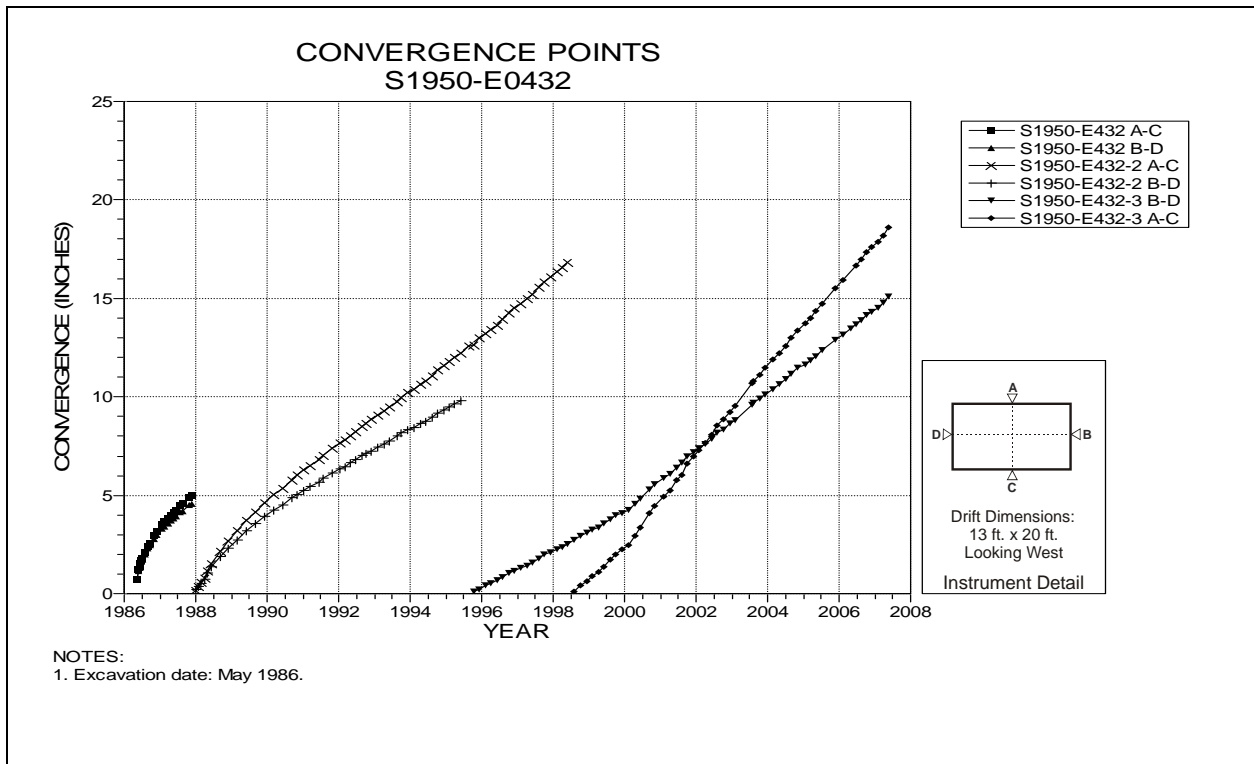


Figure 5-14 Convergence Point Array  
S1950 Drift at E432 – All Chords



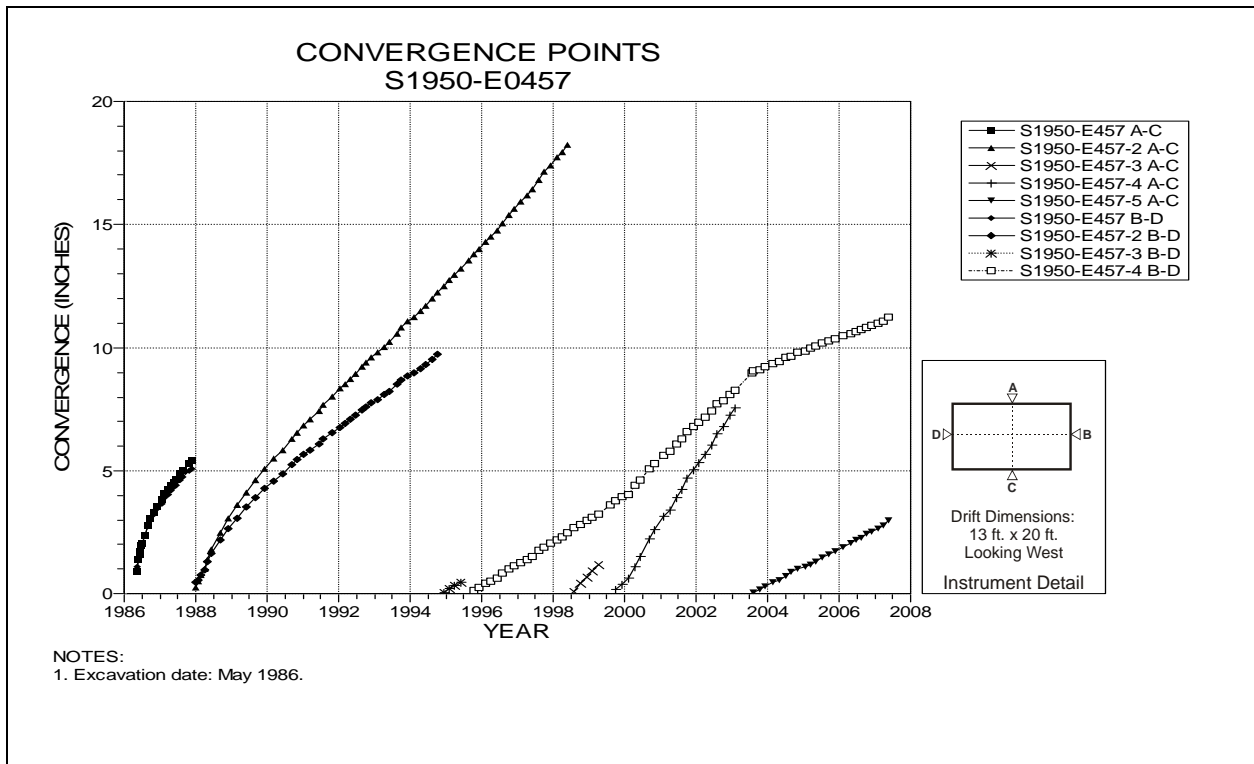


Figure 5-15 Convergence Point Array  
S1950 Drift at E457 – All Chords

**Table 5-2**  
**Panel 2 Access Drifts Data Analysis**

**CONVERGENCE POINTS**

Field Tag	Location	Figure Number	Last Reading 2006 to 2007		Cumulative Displacement (inches)	Closure Rate 2006 to 2007 (in/year)	Closure Rate 2005 to 2006 (in/year)	Rate Change Percent	Comments
			Date	Inches					
S2180-E410-2 A-C	S2180 DRIFT-E410	5-16	06/04/07	3.981	8.801	1.28	1.19	7%	
S2180-E410 B-D	S2180 DRIFT-E410	5-16	06/04/07	10.629	10.629	1.63	1.46	11%	
S2520-E410-3 A-C	S2520 DRIFT-E410	5-17	05/22/07	8.717	16.910	2.61	2.60	0%	
S2520-E410 B-D	S2520 DRIFT-E410	5-17	05/24/07	17.004	17.004	2.51	2.42	4%	

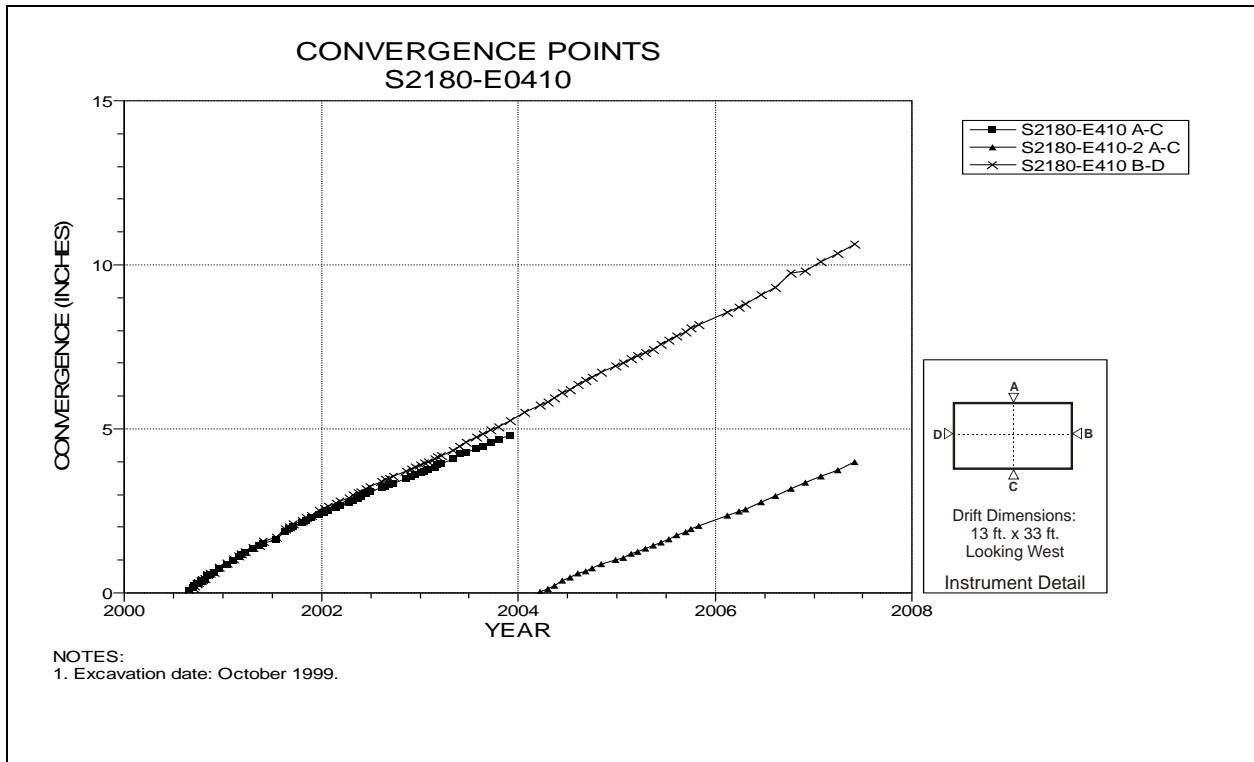


Figure 5-16 Convergence Point Array  
S2180 Drift at E410 – All Chords

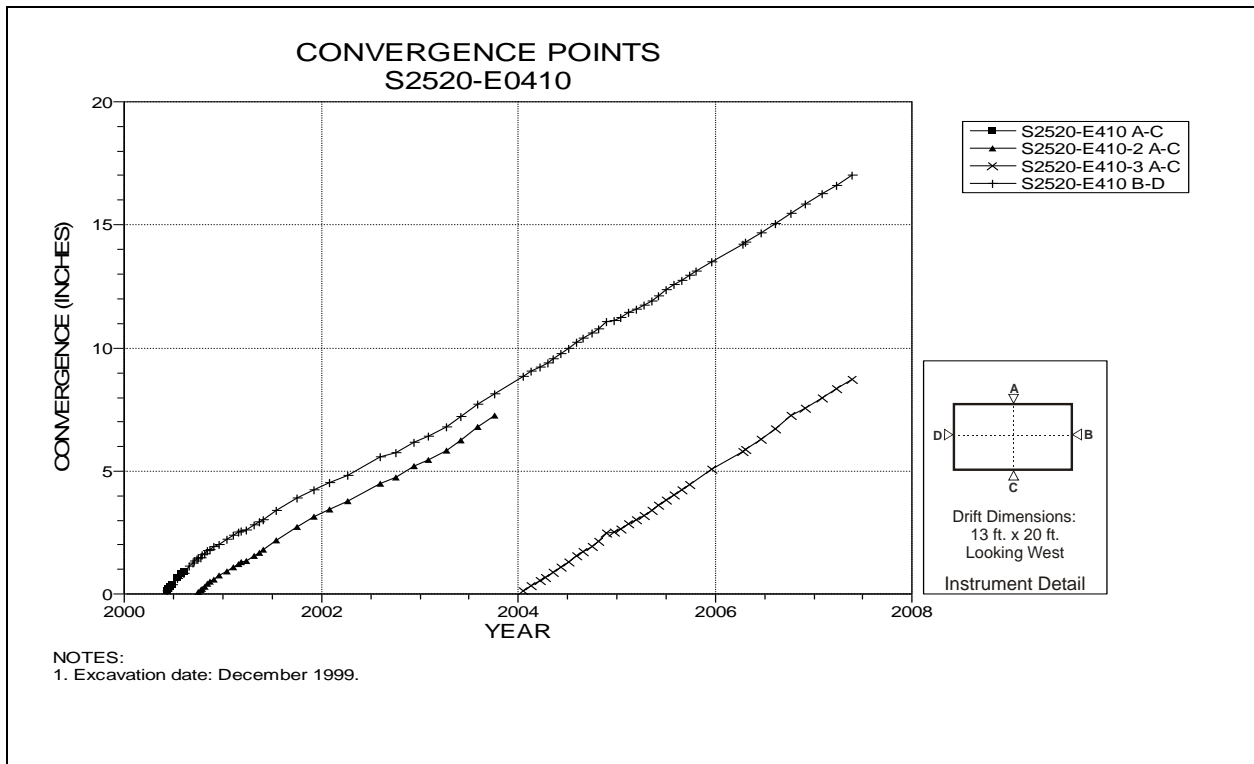


Figure 5-17 Convergence Point Array  
S2520 Drift at E410 Drift – All Chords

**Table 5-3  
Panel 3 Data Analysis**

**EXTENSOMETERS**

Field Tag	Location	Figure Number	Date of Last Reading	Collar Displacement Relative to Deepest Anchor (inches)	Displacement Rate 2006 to 2007 (in/year)	Displacement Rate 2005 to 2006 (in/year)	Rate Change Percent	Comments
51X-GE-00354-2	PANEL 3 ROOM 1 CENTER ROOF	5-18	06/25/07	17.230	8.29	3.27	154%	
51X-GE-00358	PANEL 3 ROOM 2 CENTER ROOF	5-19	06/25/07	7.689	1.88	2.32	-19%	
51X-GE-00359	PANEL 3 ROOM 3 CENTER ROOF	5-20	06/25/07	17.352	5.64	4.36	29%	
51X-GE-00362	PANEL 3 ROOM 5 CENTER ROOF	5-21	06/25/07	13.255	4.03	2.85	41%	
51X-GE-00363	PANEL 3 ROOM 6 CENTER ROOF	5-22	06/25/07	12.468	3.25	2.48	31%	
51X-GE-00366	PANEL 3 ROOM 7 CENTER ROOF	5-23	06/25/07	5.745	2.03	1.56	30%	
51X-GE-00370	S2750 DRIFT-E725 ROOF	5-24	06/25/07	6.627	2.23	1.67	34%	
51X-GE-00371	S2750 DRIFT-E1115 ROOF	5-25	06/25/07	4.853	1.53	1.45	6%	
51X-GE-00369	S3080 DRIFT-E725 ROOF	5-26	06/25/07	14.892	5.93	3.90	52%	
51X-GE-00368	S3080 DRIFT-E1120 ROOF	5-27	06/25/07	8.860	3.88	2.42	60%	

**ROCKBOLT LOAD CELLS**

Field Tag	Location	Figure Number	Date of Initial Reading	Date of Last Reading	Load (kips)	Comments
51X-WG-00300	S3080 DRIFT-E580	5-28	07/22/04	08/03/06	46.1	Threaded bar.
51X-WG-00302	S3080 DRIFT-E727	5-29	05/16/05	07/31/06	55.1	Threaded bar.

**Table 5-3 (Continued)  
Panel 3 Data Analysis**

**CONVERGENCE POINTS**

Field Tag	Location	Figure Number	Last Reading 2006 to 2007		Cumulative Displacement (inches)	Closure Rate 2006 to 2007 (in/year)	Closure Rate 2005 to 2006 (in/year)	Rate Change Percent <sup>1</sup>	Comments
			Date	Inches					
S2750-E410 A-C	S2750 DRIFT-E410	5-30	05/22/07	8.946	8.946	2.15	2.13	1%	
S2750-E410 B-D	S2750 DRIFT-E410	5-30	05/22/07	7.437	7.437	1.72	1.68	2%	
S2750-E520-2 A-C	S2750 DRIFT-E520	5-31	11/07/06	8.435	11.293	3.37	3.12	8%	
S2750-E586-3 A-C	S2750 DRIFT-E586	5-32	07/31/06	2.354	14.366	N/A	6.71	N/A	No access 2006-2007.
S2750-E586 B-D	S2750 DRIFT-E586	5-32	07/31/06	5.655	5.655	N/A	2.62	N/A	No access 2006-2007.
S2750-E660-3 A-C	S2750 DRIFT-E660	5-33	07/31/06	1.399	9.509	N/A	4.19	N/A	No access 2006-2007.
S3080-E410-2 A-C	S3080 DRIFT-E410	5-34	06/04/07	7.582	10.12	2.66	2.68	-1%	
S3080-E410 B-D	S3080 DRIFT-E410	5-34	06/04/07	9.205	9.205	2.18	2.27	-4%	
S3080-E520-3 A-C	S3080 DRIFT-E520	5-35	02/13/07	5.637	16.152	4.82	10.23	-53%	
S3080-E586-3 A-C	S3080 DRIFT-E586	5-36	09/25/06	5.608	17.299	11.07	12.37	-11%	
S3080-E586 B-D	S3080 DRIFT-E586	5-36	07/20/06	6.511	6.511	4.10	3.21	28%	
S3080-E660-3 A-C	S3080 DRIFT-E660	5-37	09/25/06	2.804	14.081	5.79	5.93	-2%	
S3080-E725-2 A-C	S3080 DRIFT-E725	5-38	08/02/06	2.445	12.856	7.46	7.36	1%	
S3080-E725 B-D	S3080 DRIFT-E725	5-38	08/02/06	6.956	6.956	3.34	3.32	1%	
S3080-E790-3 A-C	S3080 DRIFT-E790	5-39	08/02/06	3.186	14.628	6.48	5.44	19%	
E520-S2833-3 A-C	E520 DRIFT-S2833	5-40	12/07/06	4.055	15.944	3.96	6.77	-42%	
E520-S2916-3 A-C	E520 DRIFT-S2916	5-41	12/07/06	6.486	21.209	9.26	7.51	23%	
E520-S2998-3 A-C	E520 DRIFT-S2998	5-42	01/17/07	4.706	20.173	4.34	6.82	-36%	
E660-S2833-3 A-C	E660 DRIFT-S2833	5-43	09/06/06	2.786	12.324	4.28	4.31	-1%	
E660-S2916-3 A-C	E660 DRIFT-S2916	5-44	09/06/06	2.605	14.162	4.10	4.09	0%	
E660-S2998-3 A-C	E660 DRIFT-S2998	5-45	09/06/06	2.799	16.203	4.28	4.26	0%	

<sup>1</sup> NA indicates insufficient data to compare annualized rates.

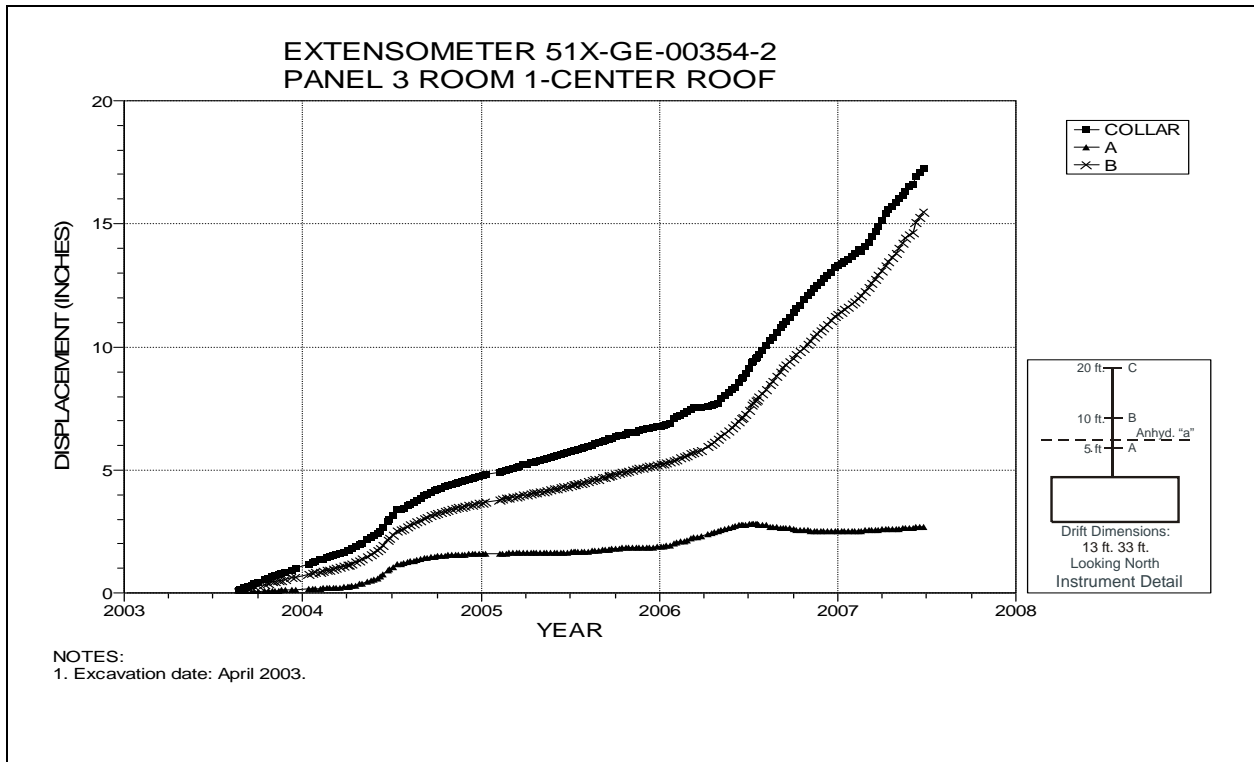


Figure 5-18 Extensometer 51X-GE-00354-2  
Room 1, Panel 3 – Room Center – Roof

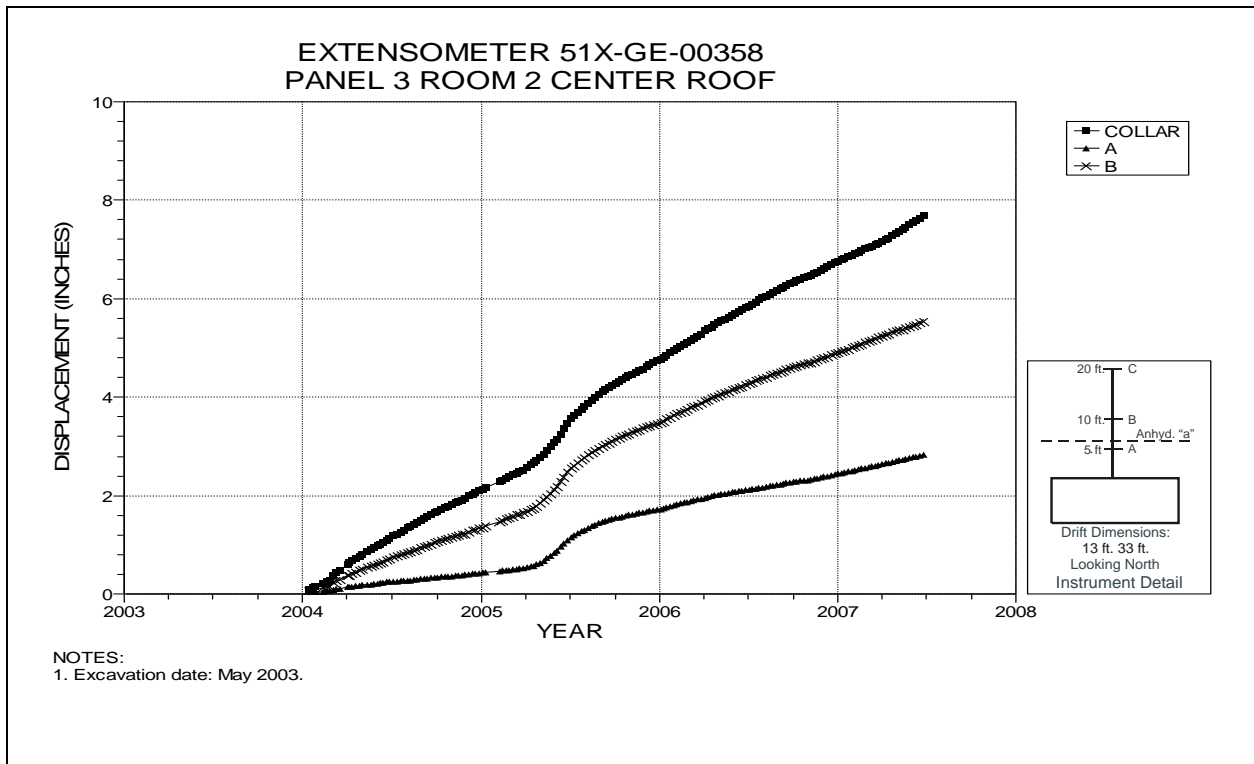


Figure 5-19 Extensometer 51X-GE-00358  
Room 2, Panel 3 – Room Center – Roof

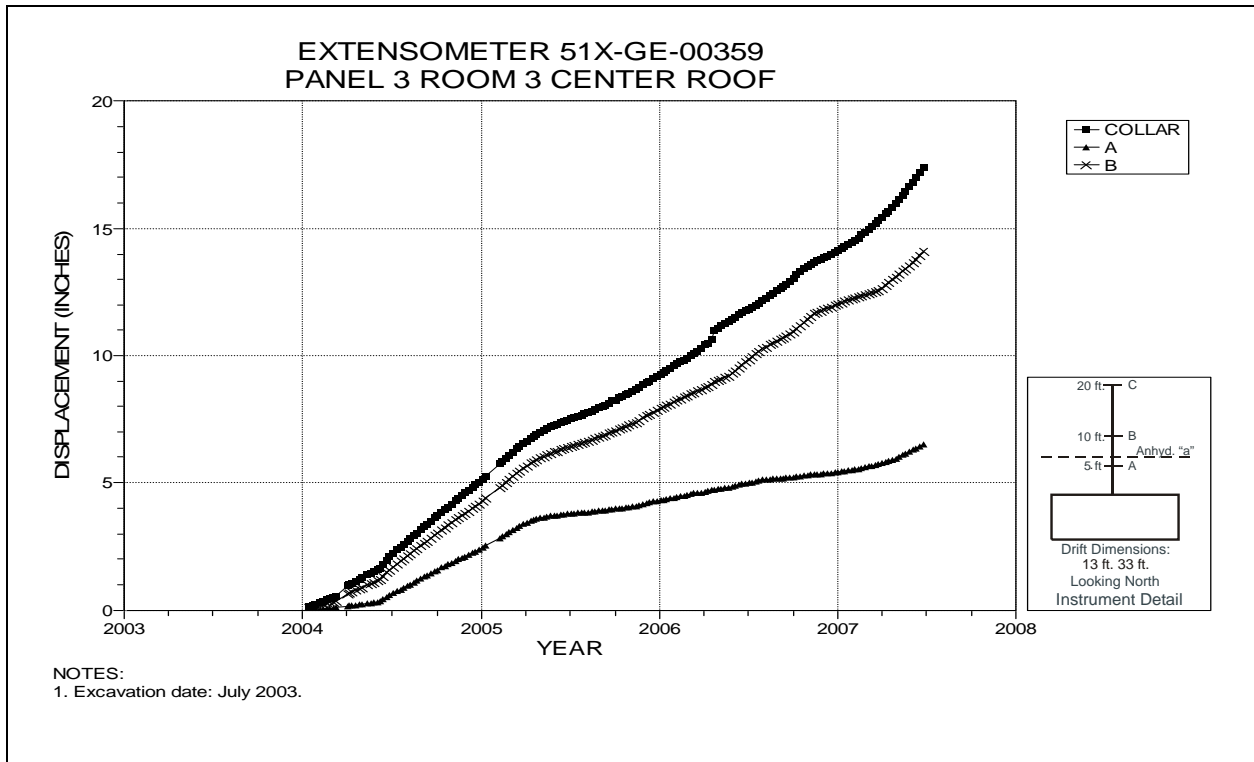


Figure 5-20 Extensometer 51X-GE-00359  
Room 3, Panel 3 – Room Center – Roof

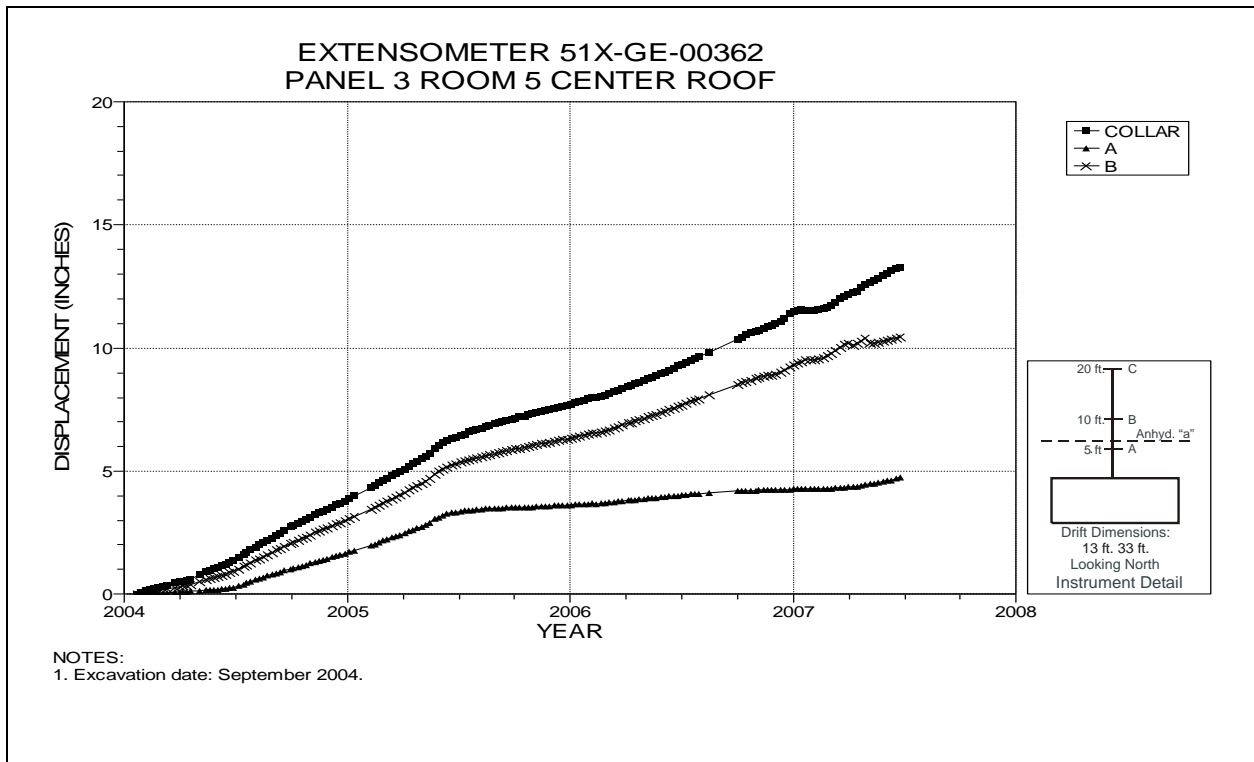


Figure 5-21 Extensometer 51X-GE-00362  
Room 5, Panel 3 – Room Center – Roof

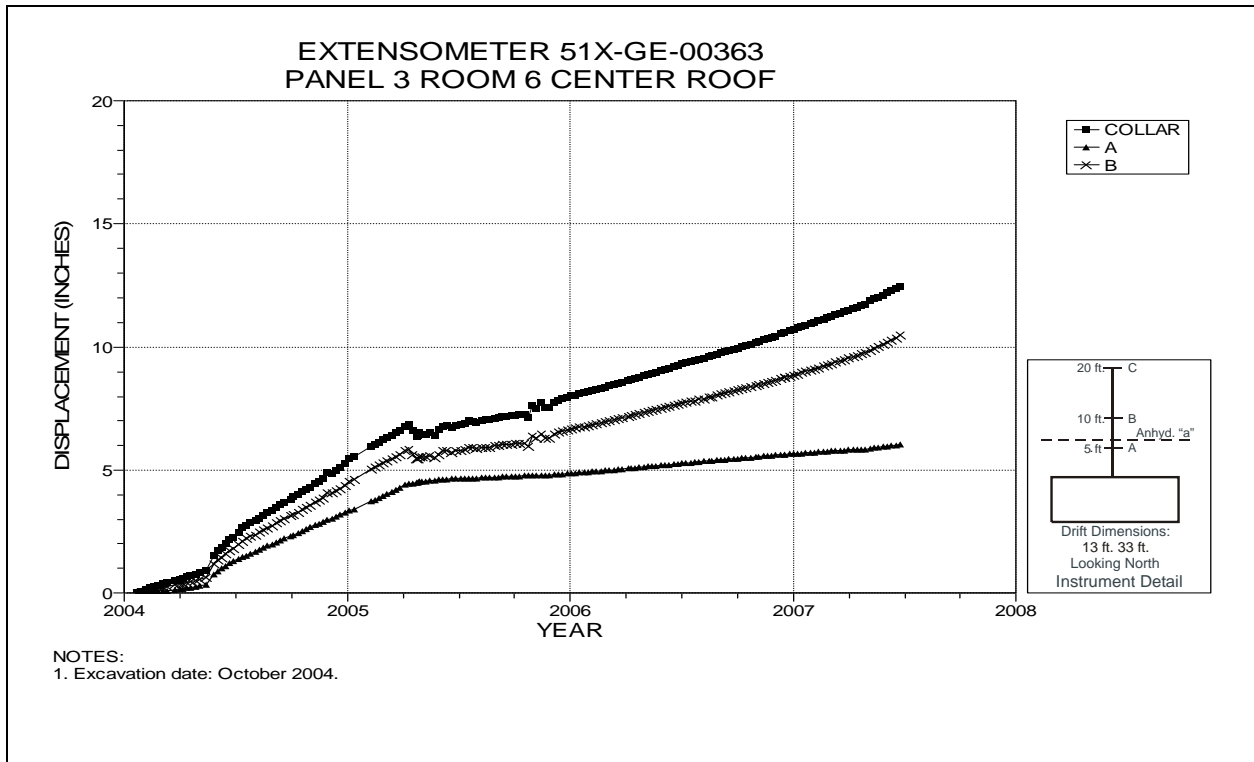


Figure 5-22 Extensometer 51X-GE-00363  
Room 6, Panel 3 – Room Center – Roof

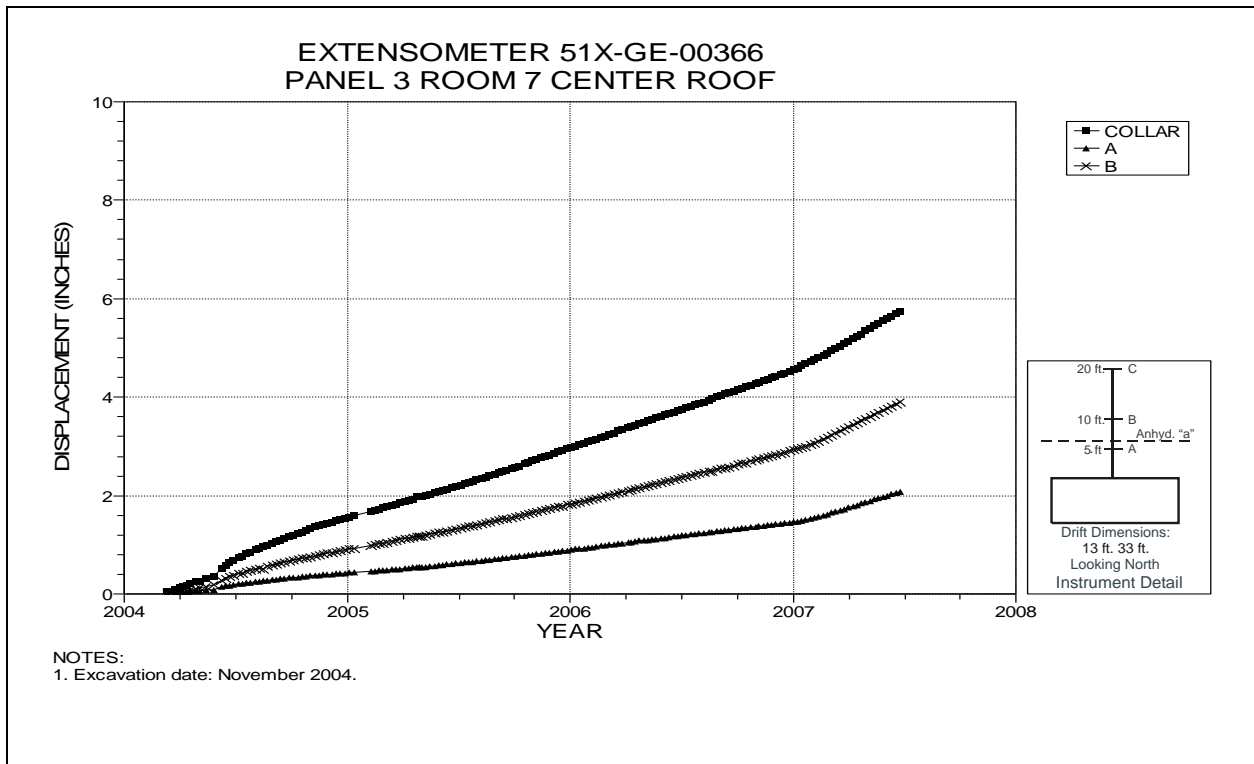


Figure 5-23 Extensometer 51X-GE-00366  
Room 7, Panel 3 – Room Center – Roof



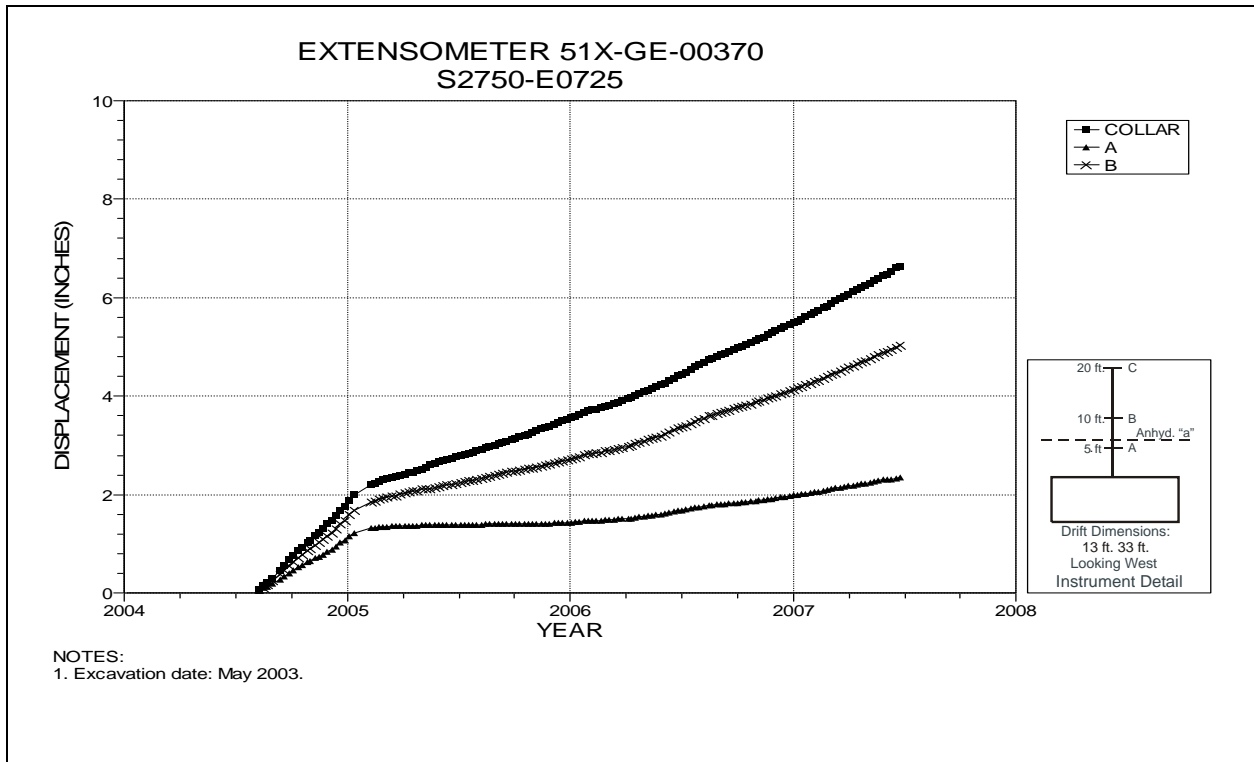


Figure 5-24 Extensometer 51X-GE-00370  
S2750 Drift at E725 – Roof

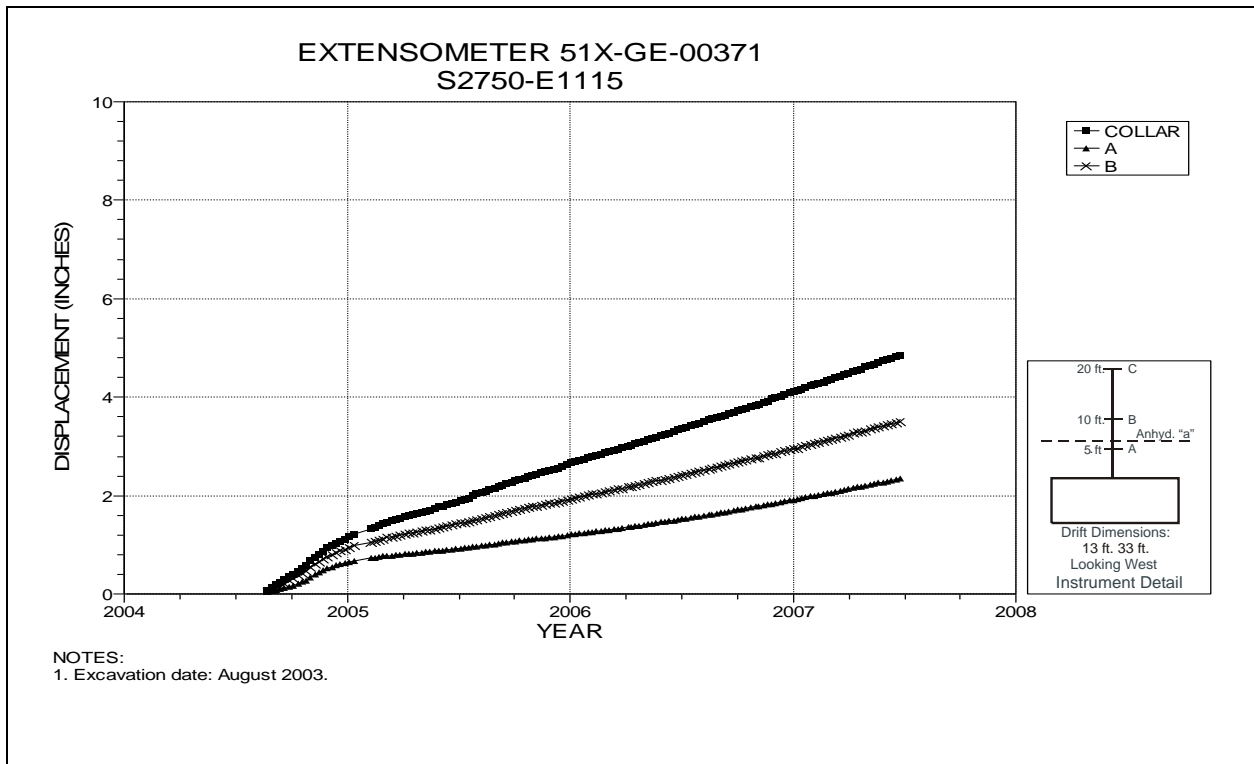


Figure 5-25 Extensometer 51X-GE-00371  
S2750 Drift at E1115 – Roof

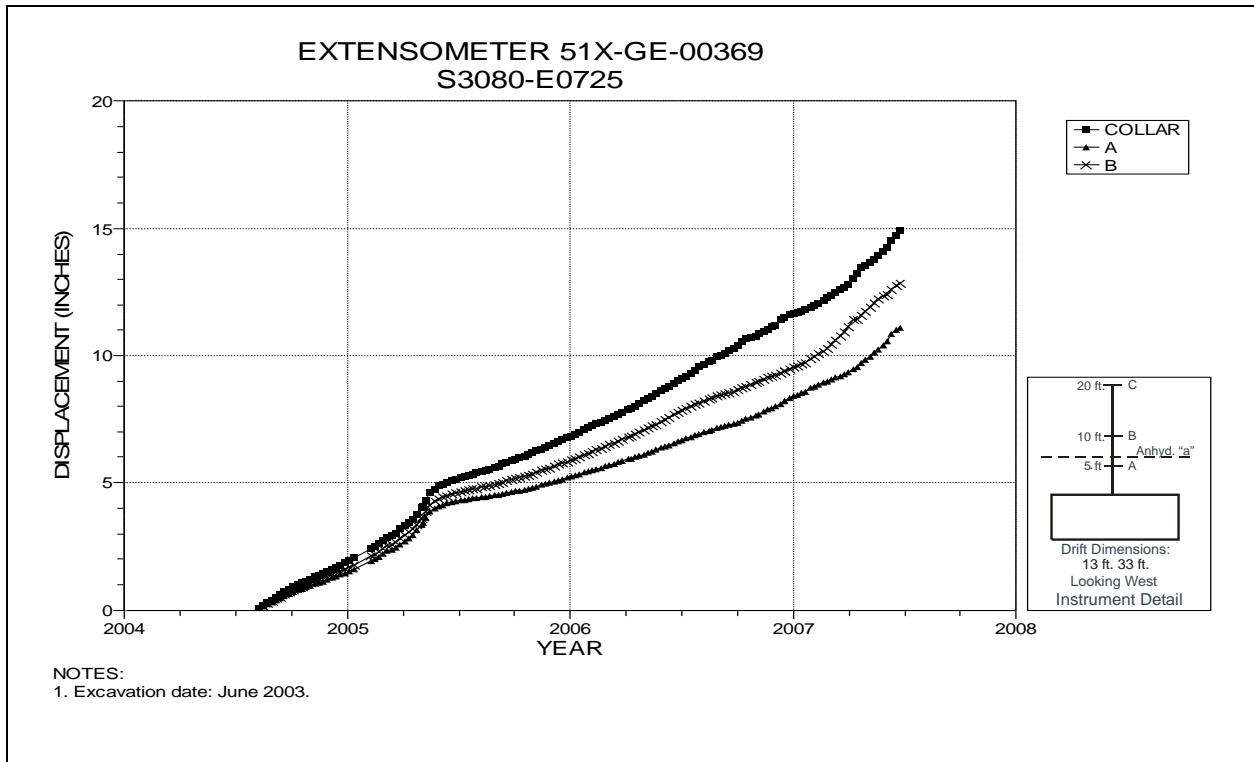


Figure 5-26 Extensometer 51X-GE-00369  
S3080 Drift at E725 – Roof

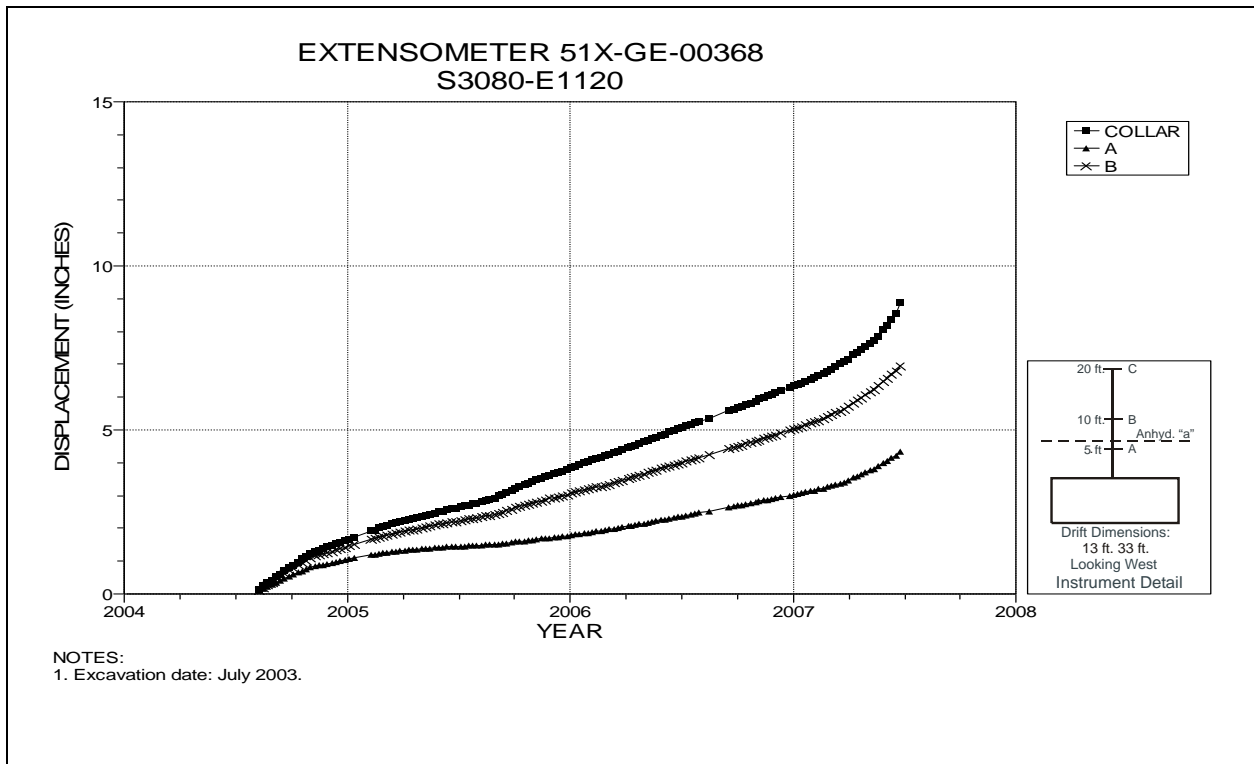


Figure 5-27 Extensometer 51X-GE-00368  
S3080 Drift at E1120 – Roof

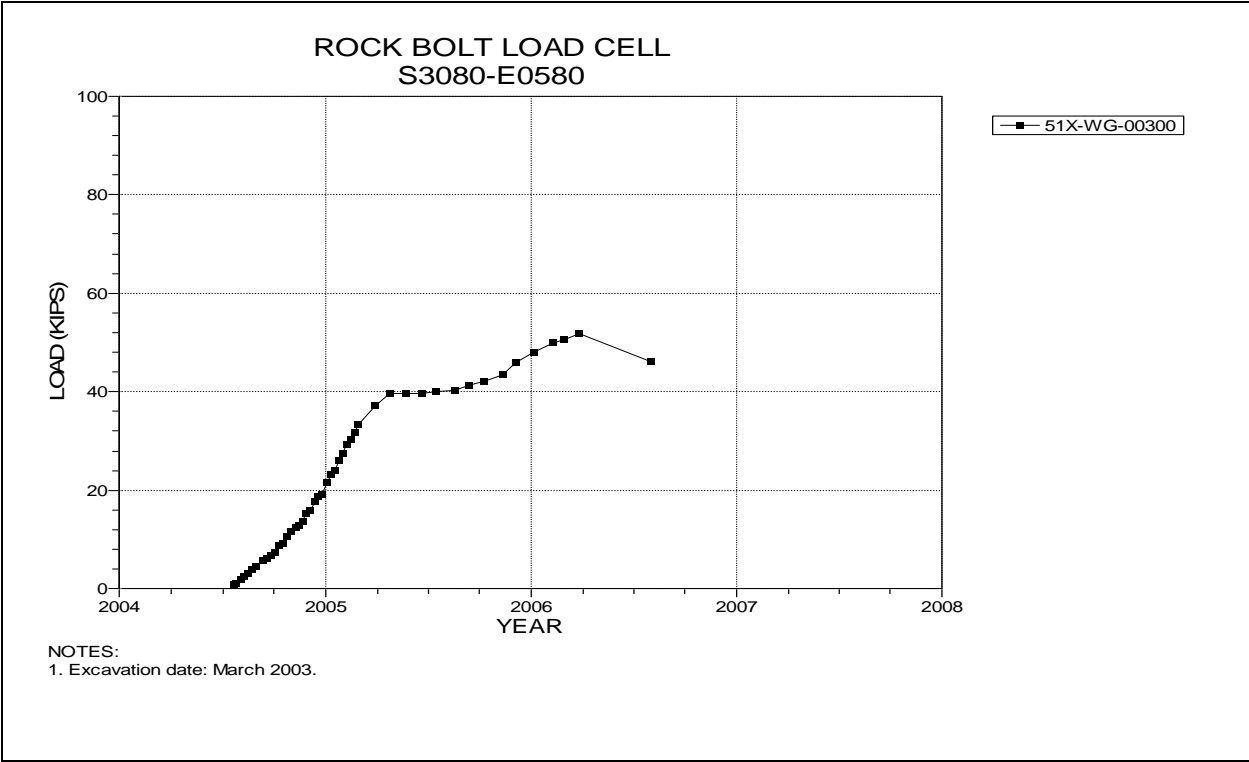


Figure 5-28 Rock Bolt Load Cell  
S3080 Drift at E580 – Roof

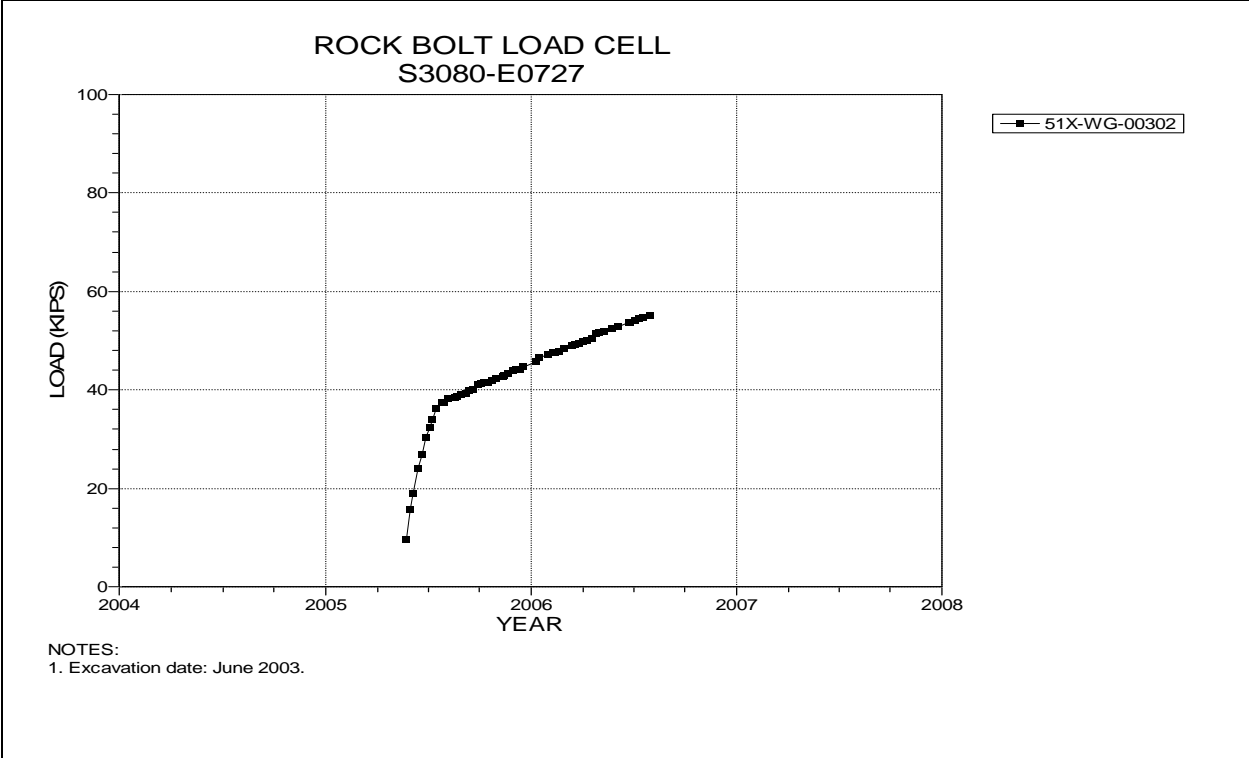


Figure 5-29 Rock Bolt Load Cells  
S3080 Drift at E727 – Roof

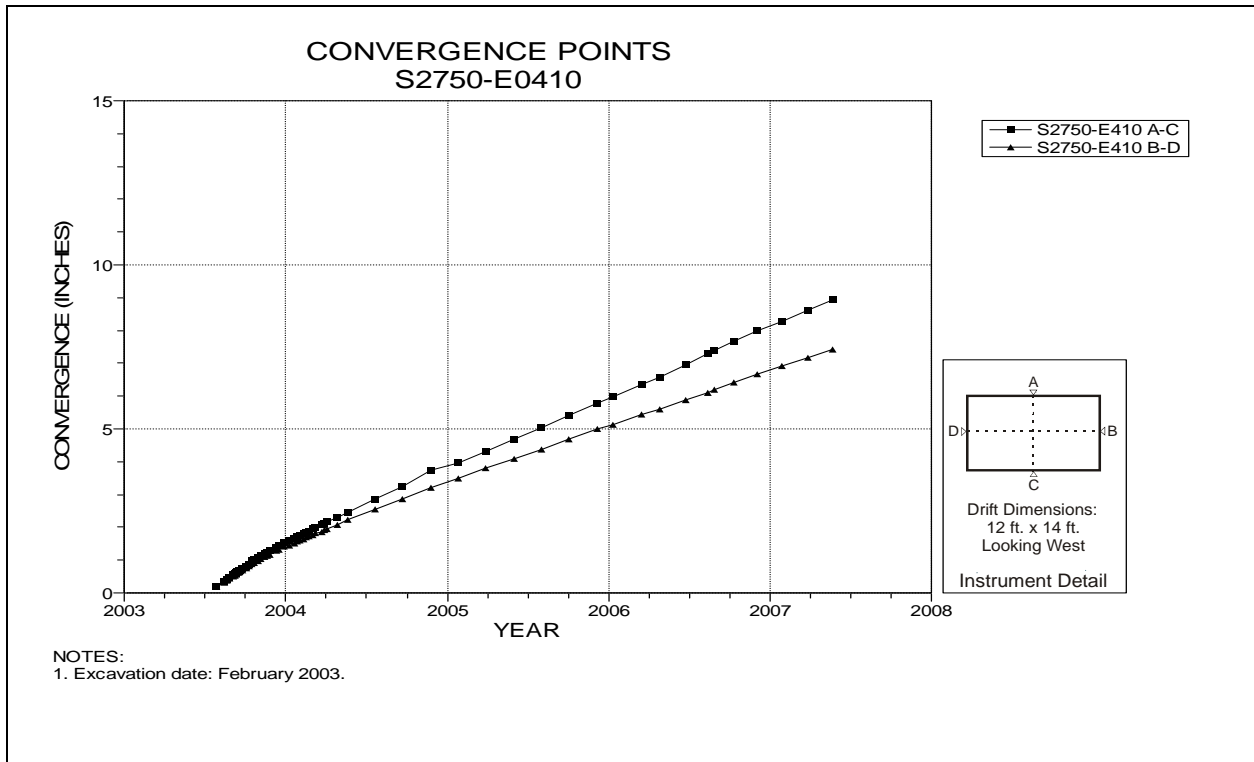


Figure 5-30 Convergence Point Array  
S2750 Drift at E410 – All Chords

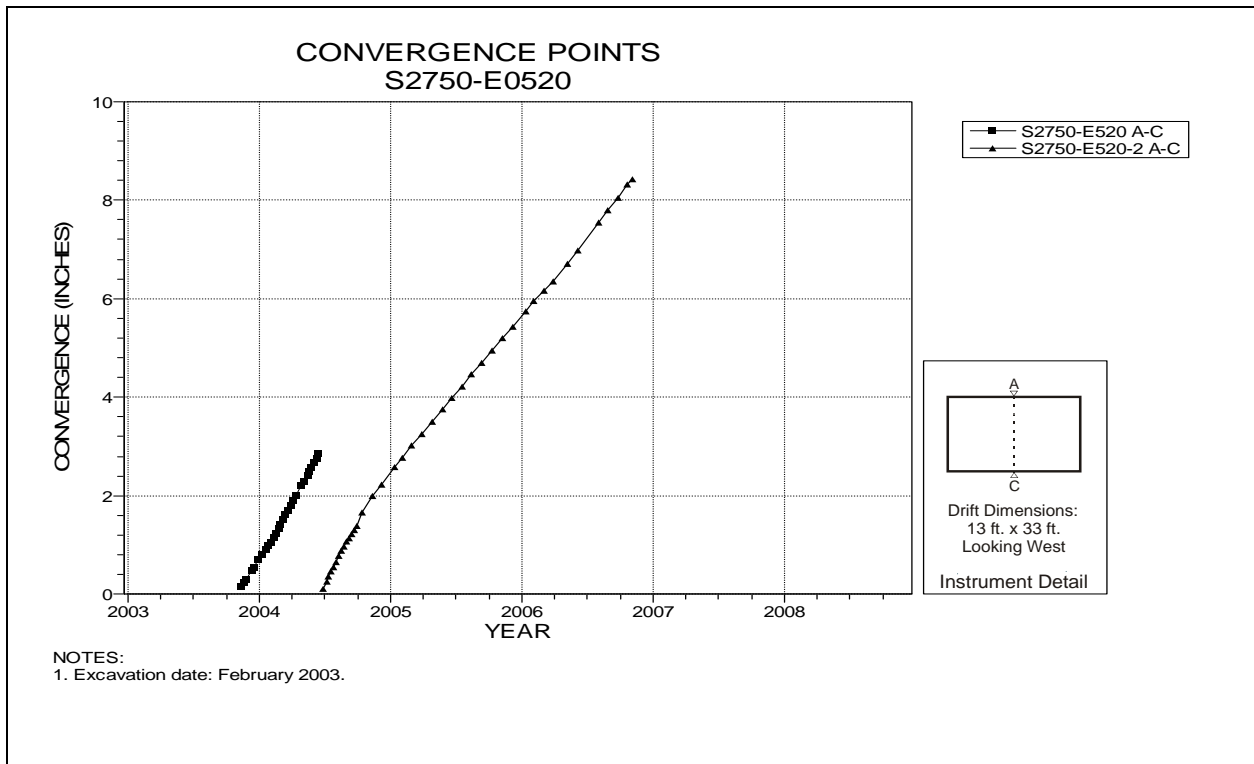


Figure 5-31 Convergence Point Array  
S2750 Drift at E520 Drift Intersection (Room 1, Panel 3) – Roof to Floor

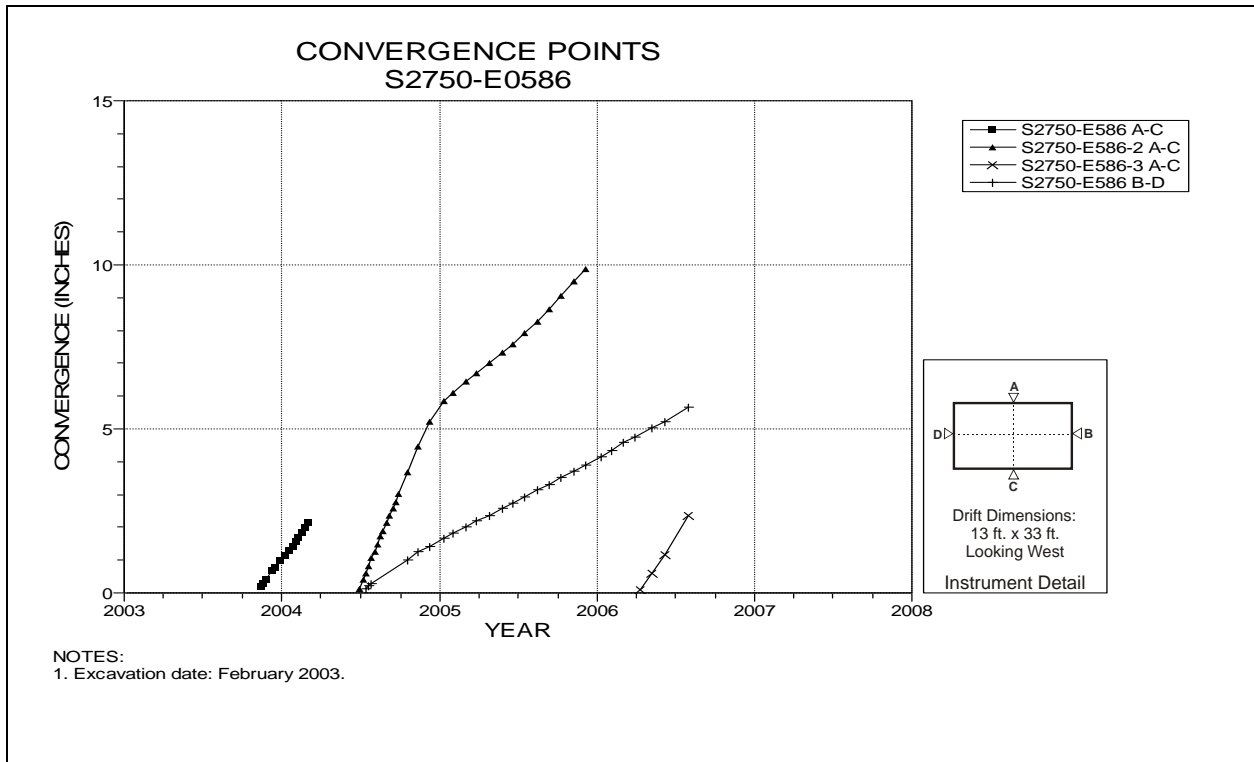


Figure 5-32 Convergence Point Array  
S2750 Drift at E586 – Roof to Floor

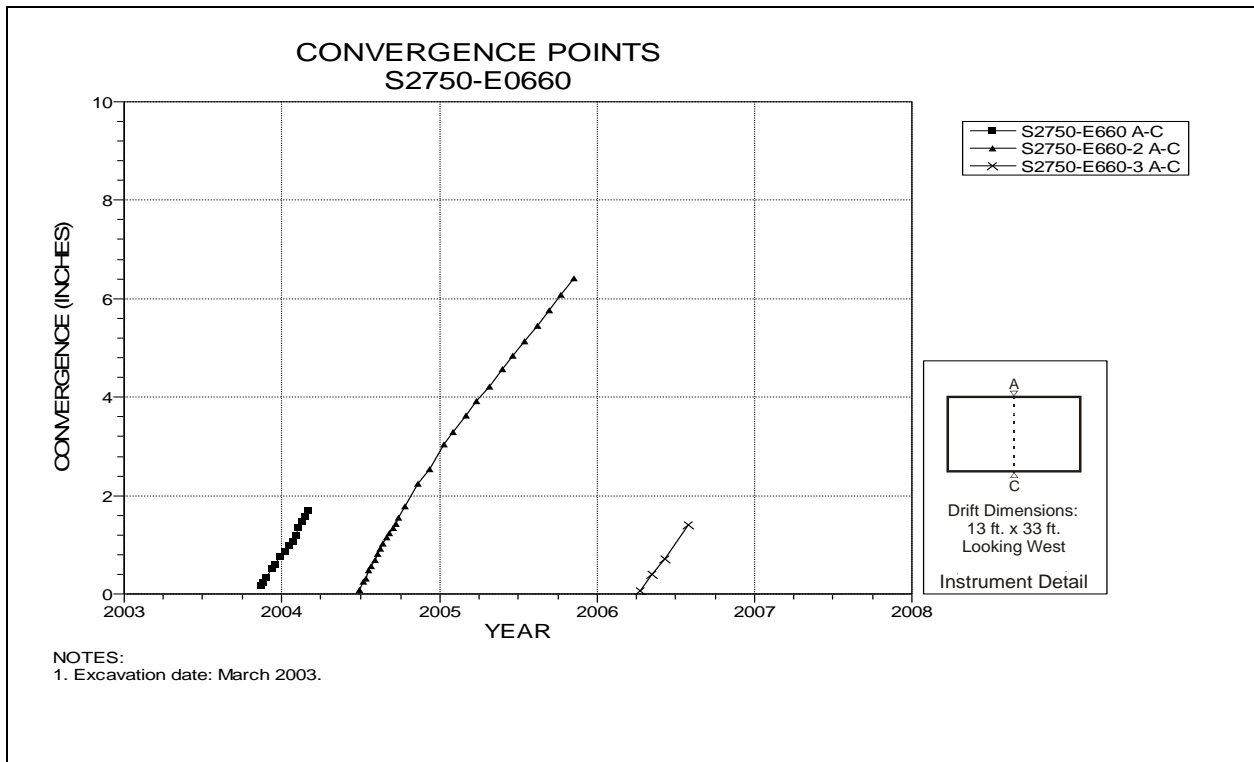


Figure 5-33 Convergence Point Array  
S2750 Drift at E660 Drift Intersection (Room 2, Panel 3) – Roof to Floor

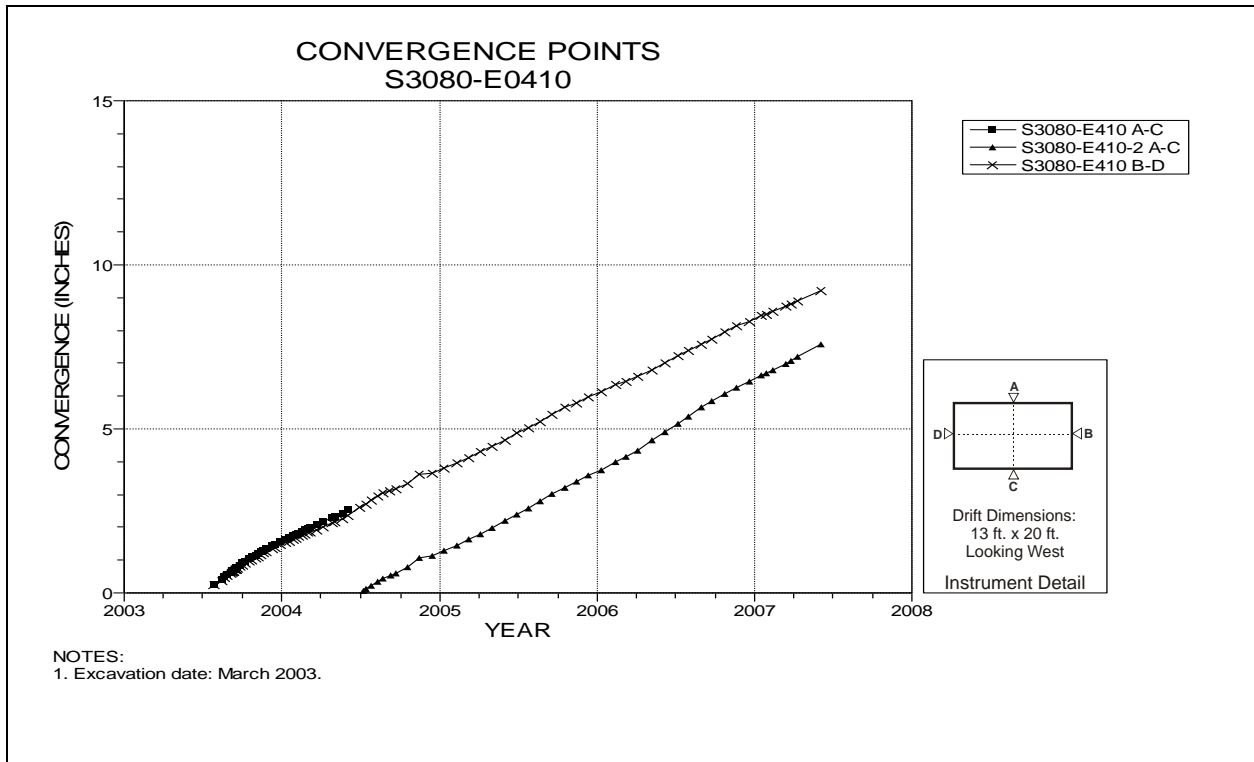


Figure 5-34 Convergence Point Array  
S3080 Drift at E410 – All Chords

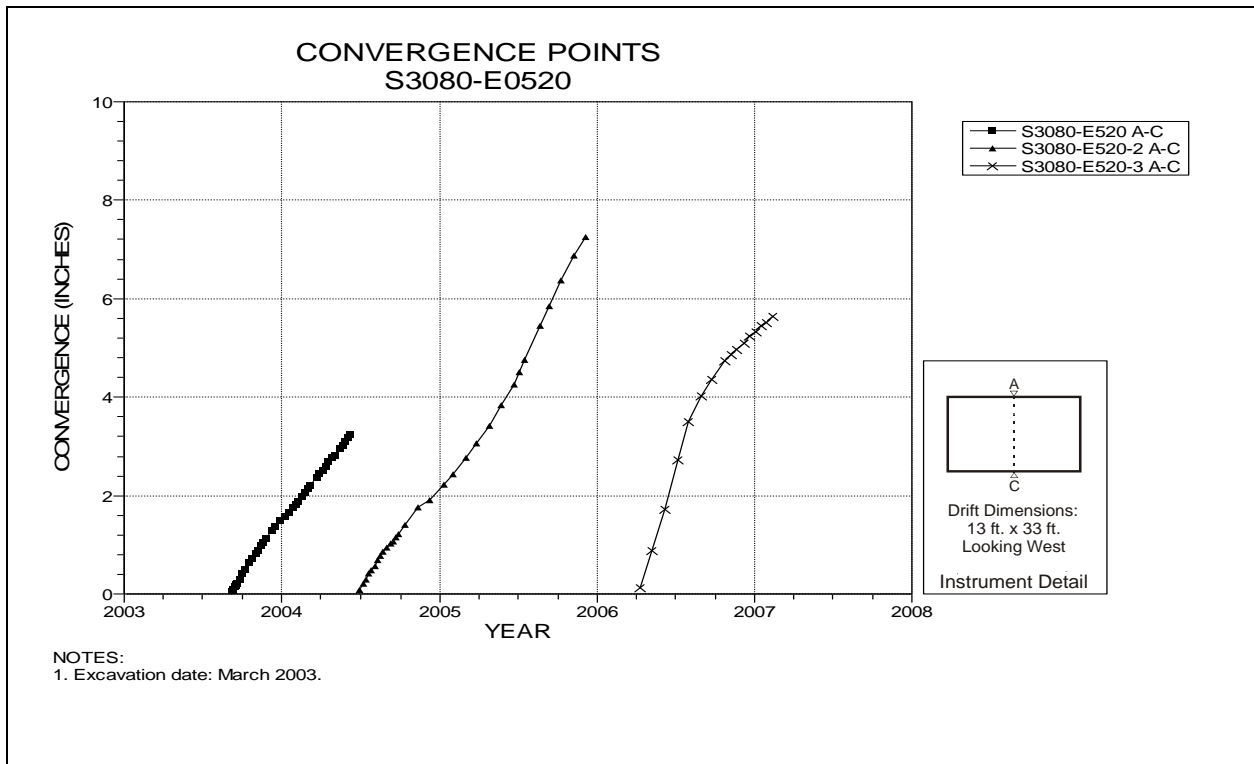


Figure 5-35 Convergence Point Array  
S3080 Drift at E520 Drift Intersection (Room 1, Panel 3) – Roof to Floor

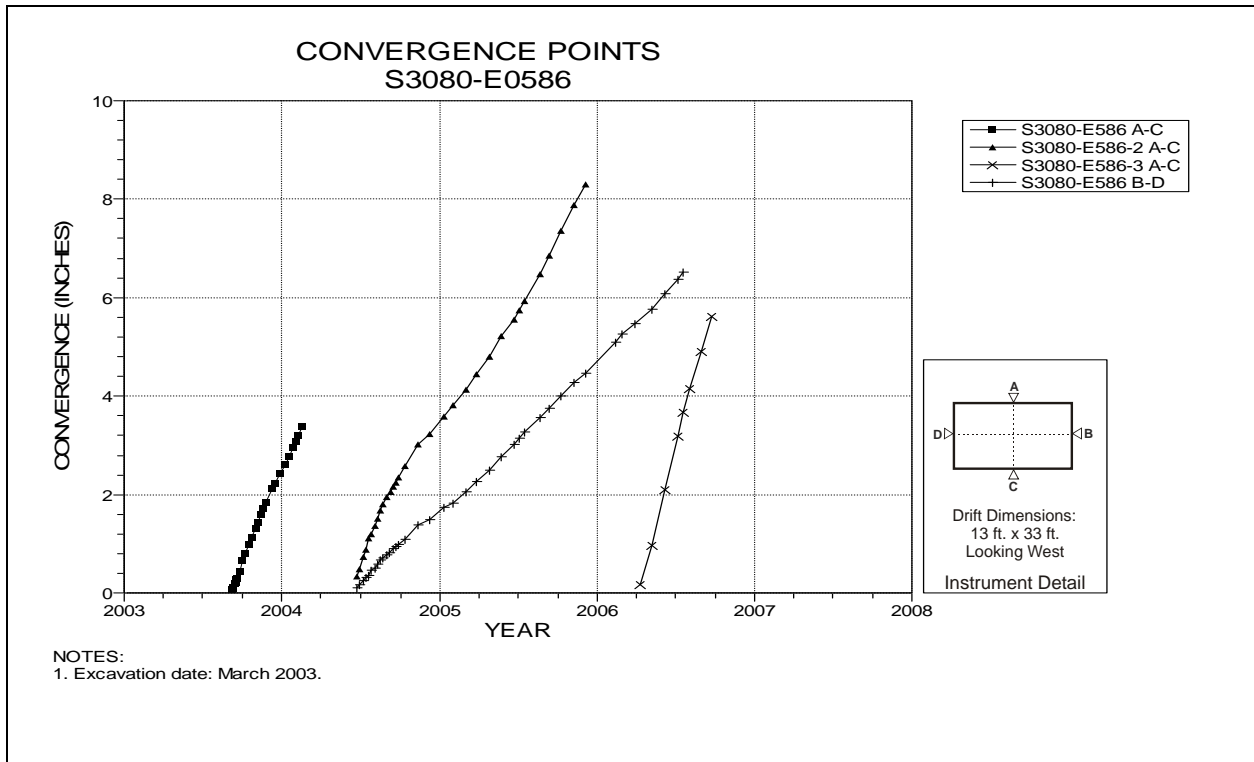


Figure 5-36 Convergence Point Array  
S3080 Drift at E586 – All Chords

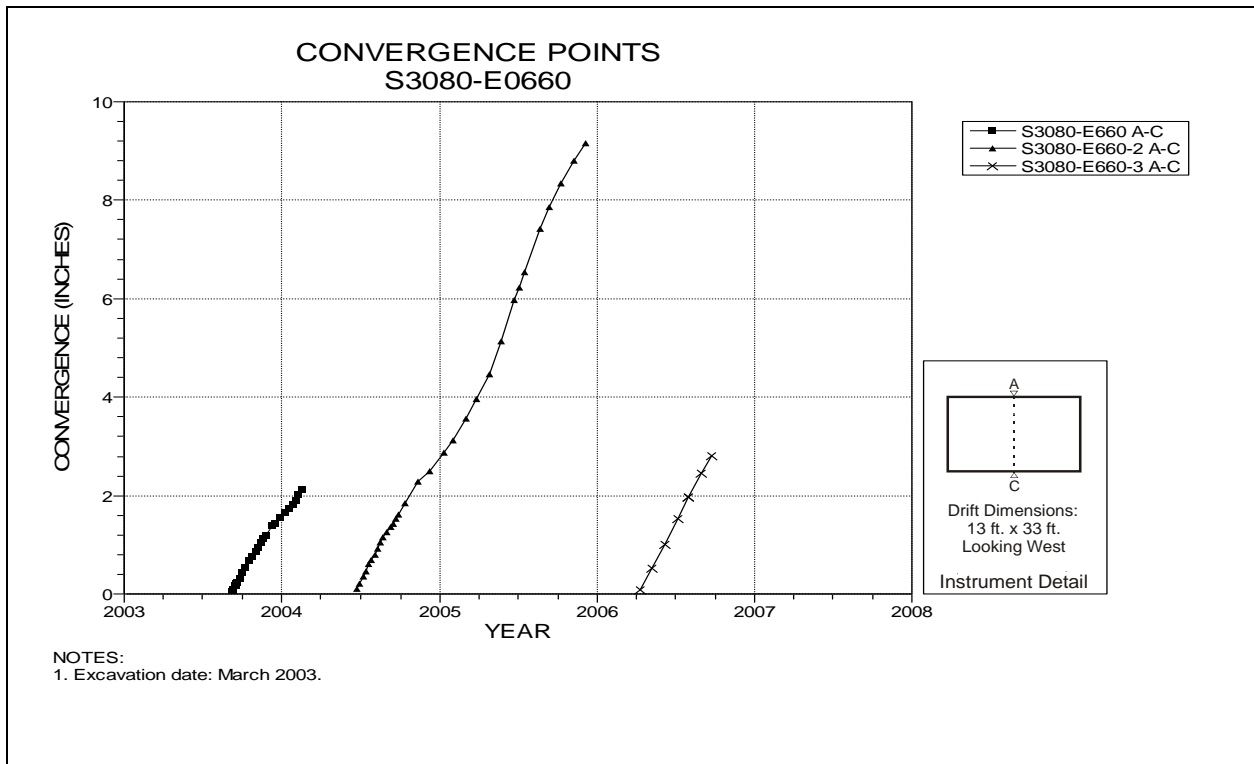


Figure 5-37 Convergence Point Array  
S3080 Drift at E660 Drift Intersection (Room 2, Panel 3) – Roof to Floor

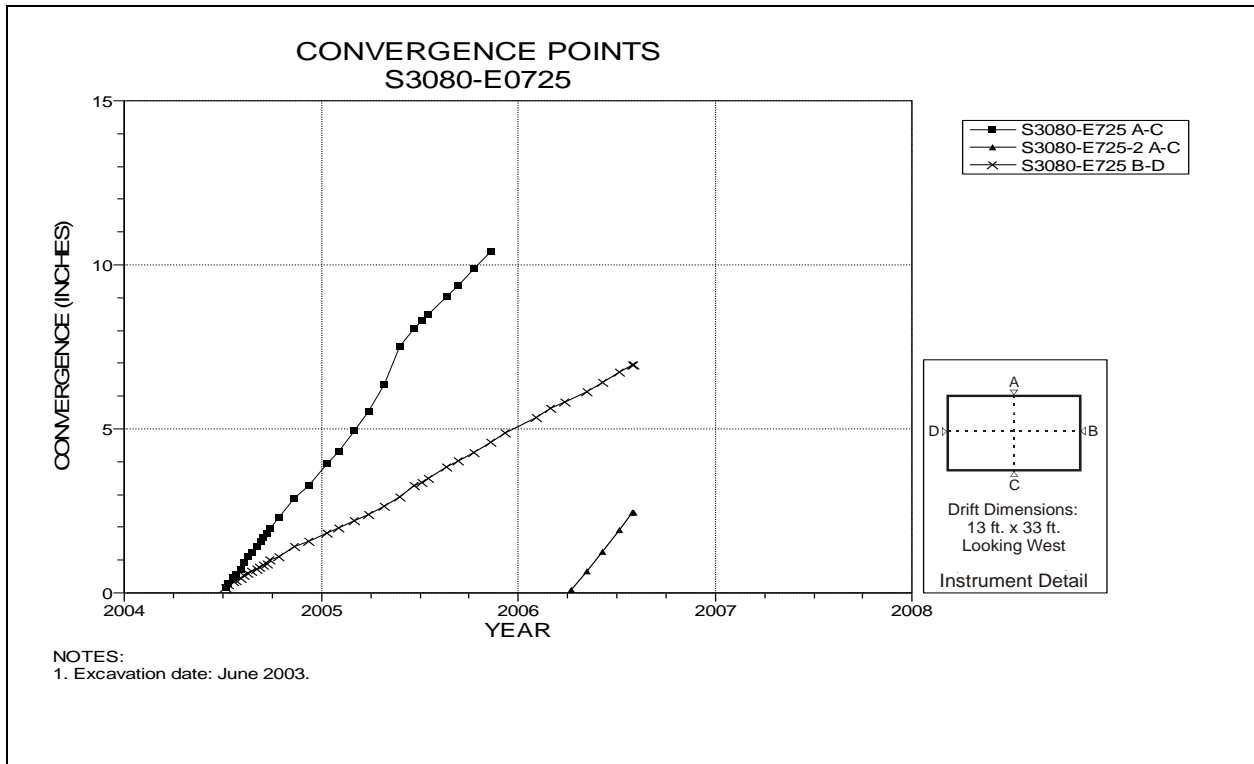


Figure 5-38 Convergence Point Array  
S3080 Drift at E725 – All Chords

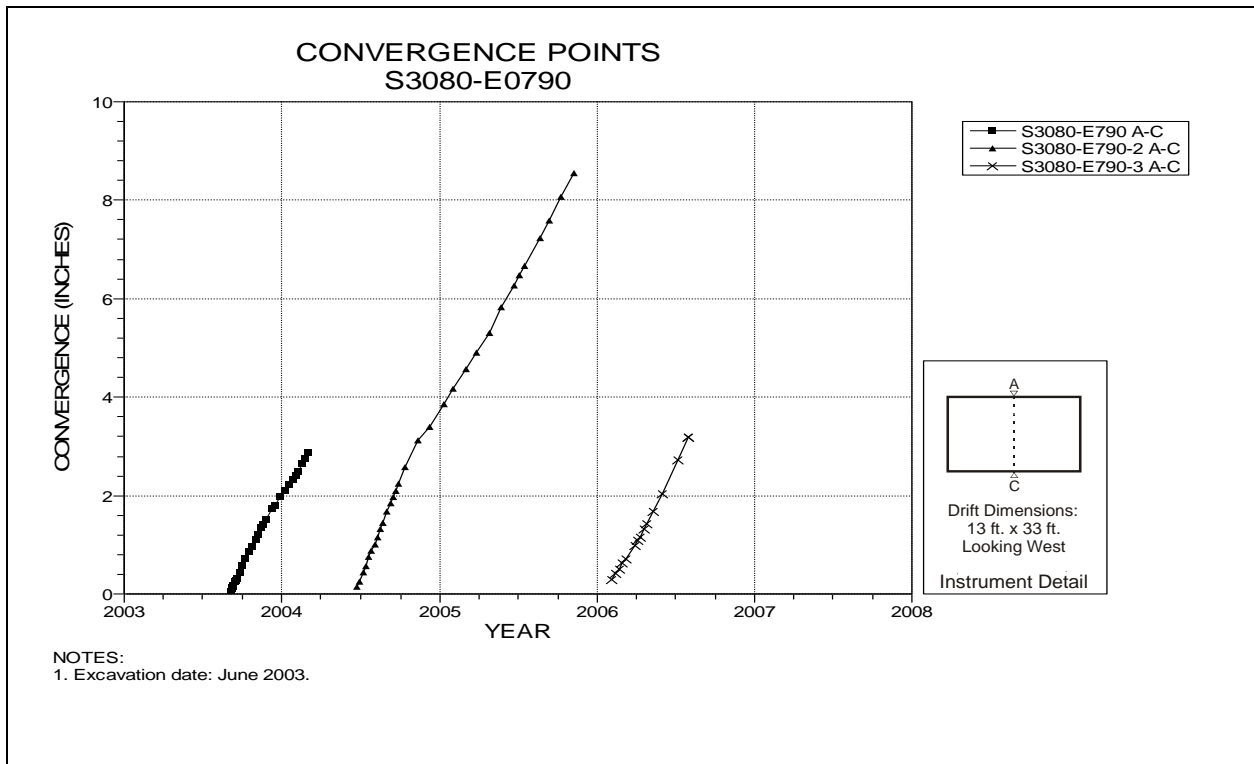


Figure 5-39 Convergence Point Array  
S3080 Drift at E790 Drift Intersection (Room 3, Panel 3) – Roof to Floor



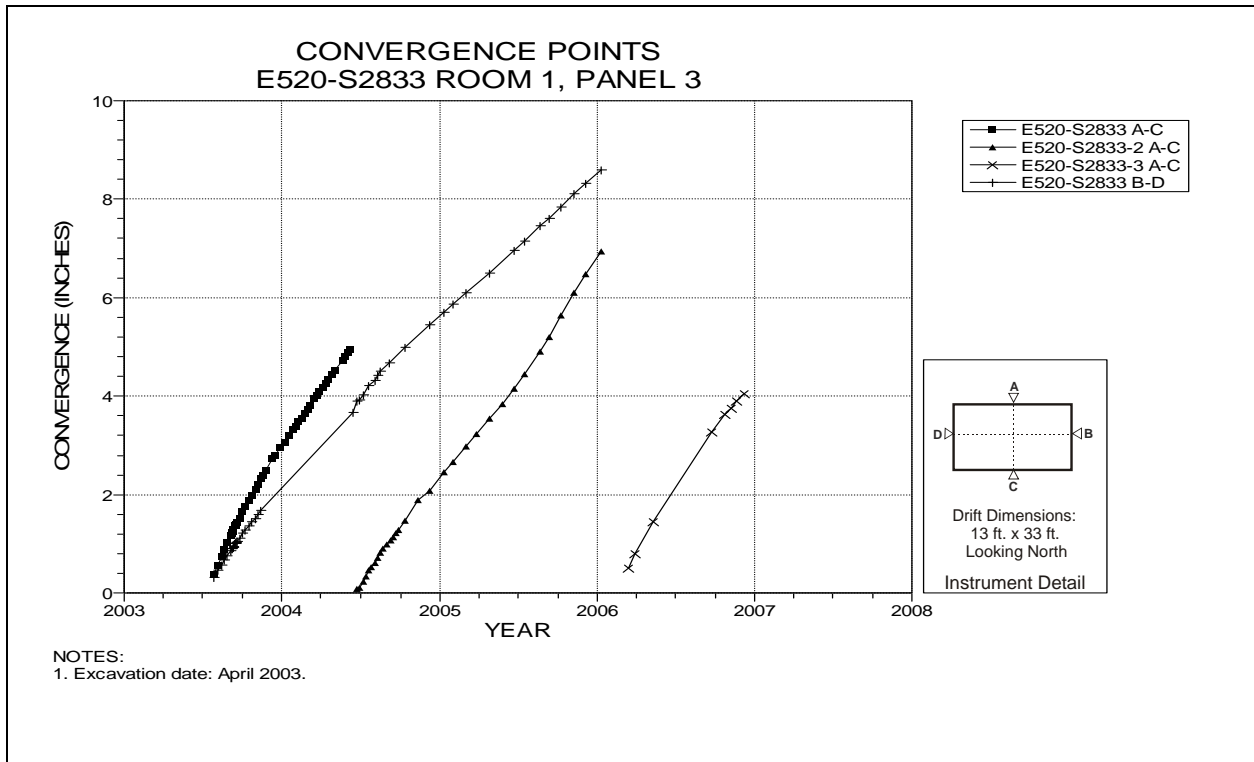


Figure 5-40 Convergence Point Array  
Room 1, Panel 3 at S2833 – All Chords

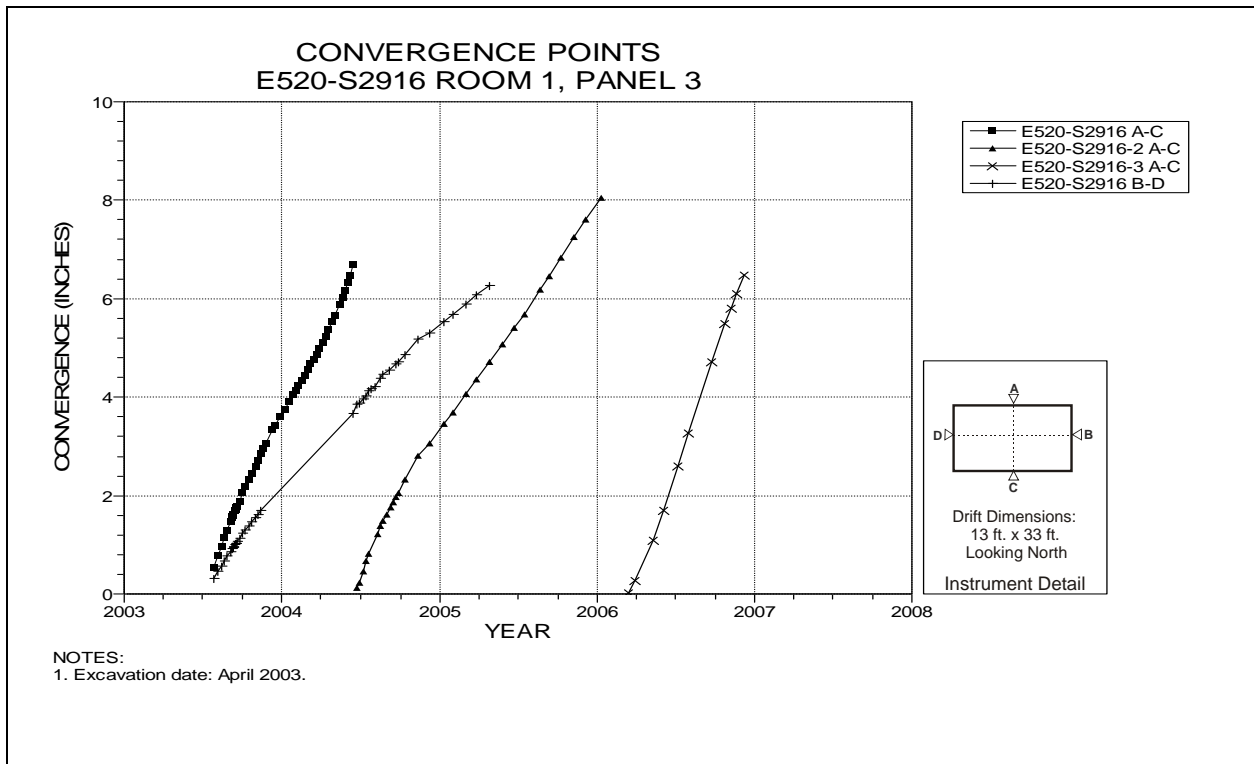


Figure 5-41 Convergence Point Array  
Room 1, Panel 3 at S2916 – Room Center – All Chords

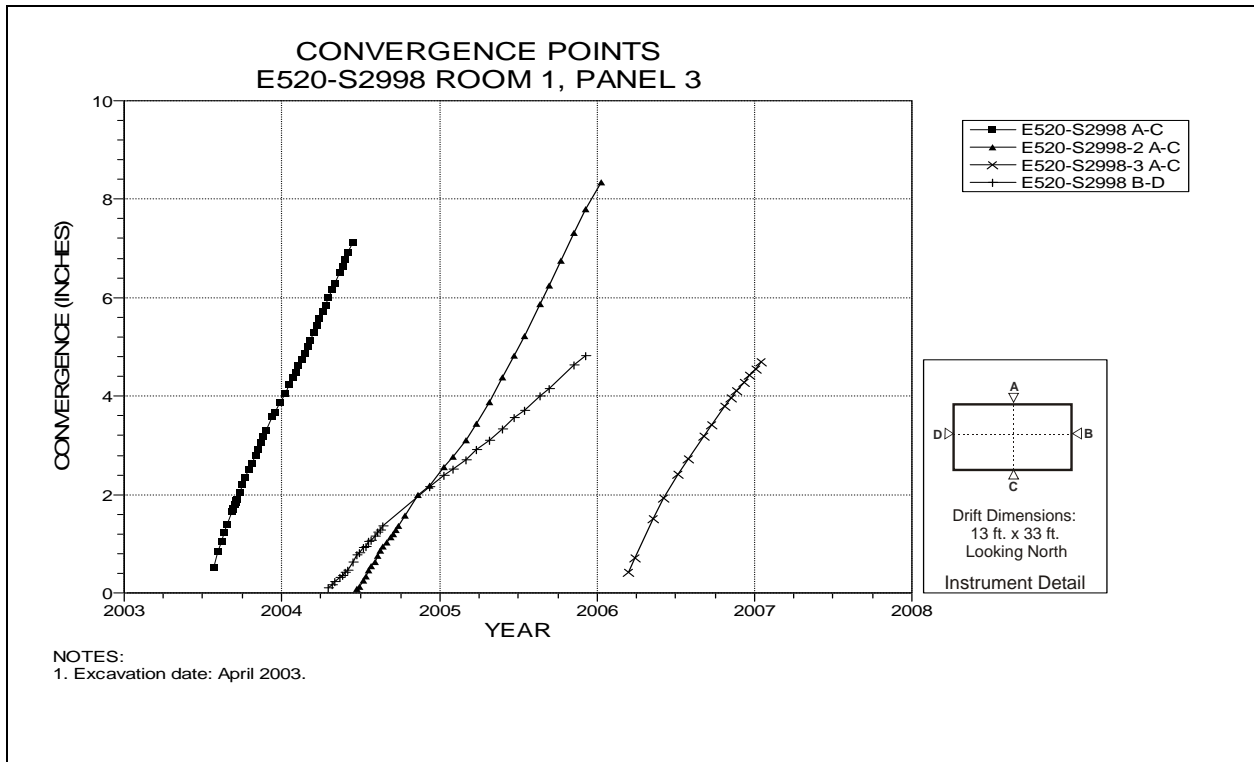


Figure 5-42 Convergence Point Array  
Room 1, Panel 3 at S2998 – All Chords

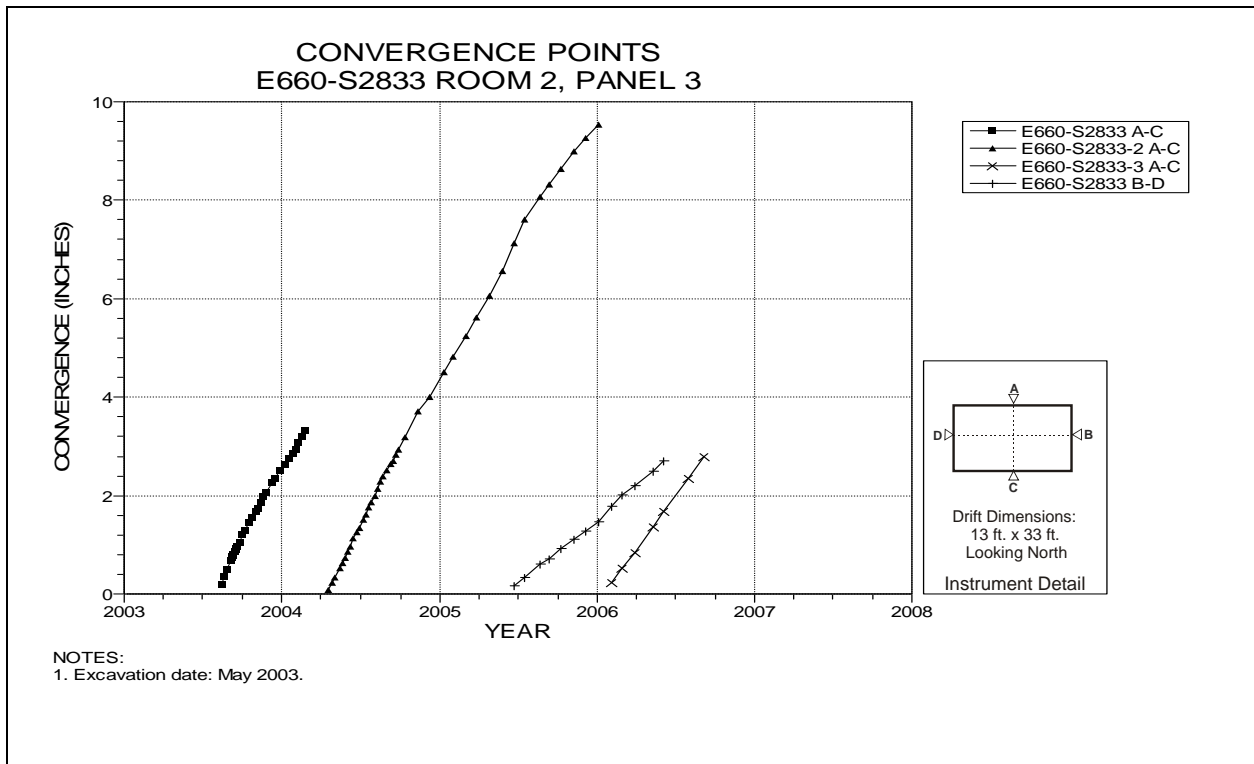


Figure 5-43 Convergence Point Array  
Room 2, Panel 3 at S2833 – Roof to Floor

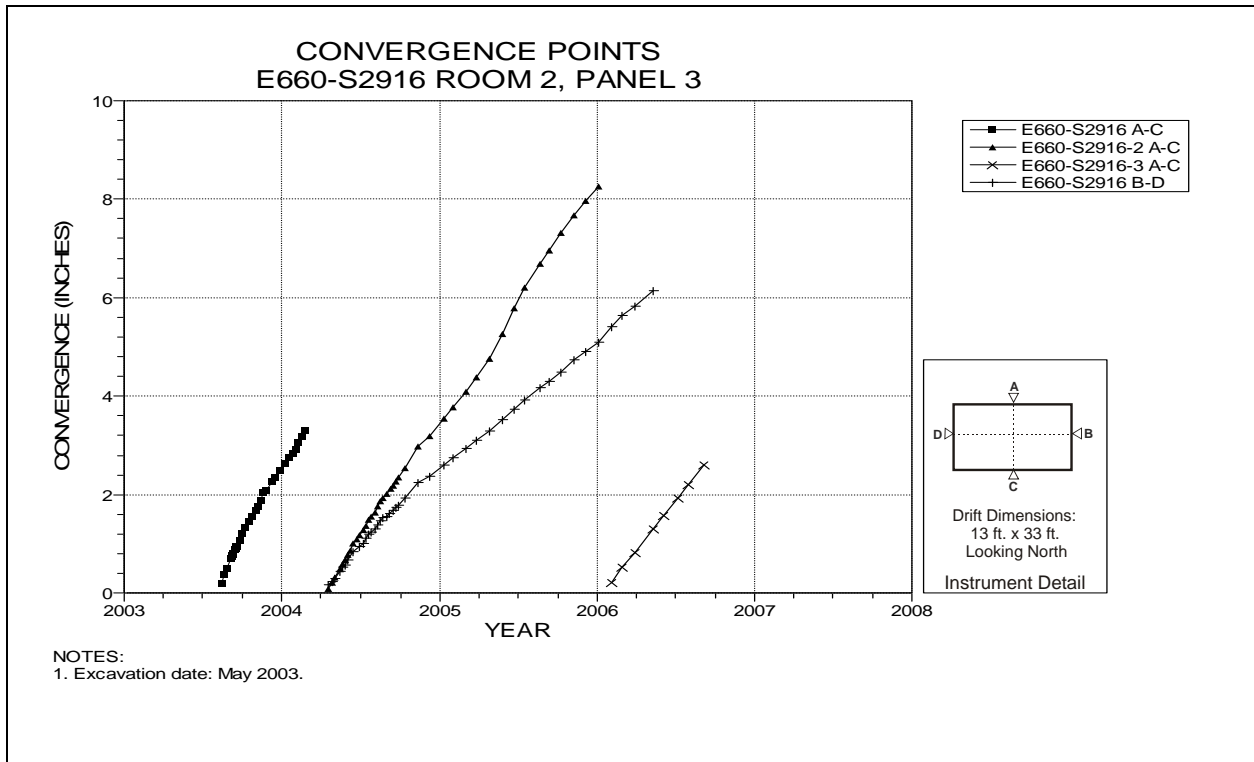


Figure 5-44 Convergence Point Array  
Room 2, Panel 3 at S2916 – Room Center – All Chords

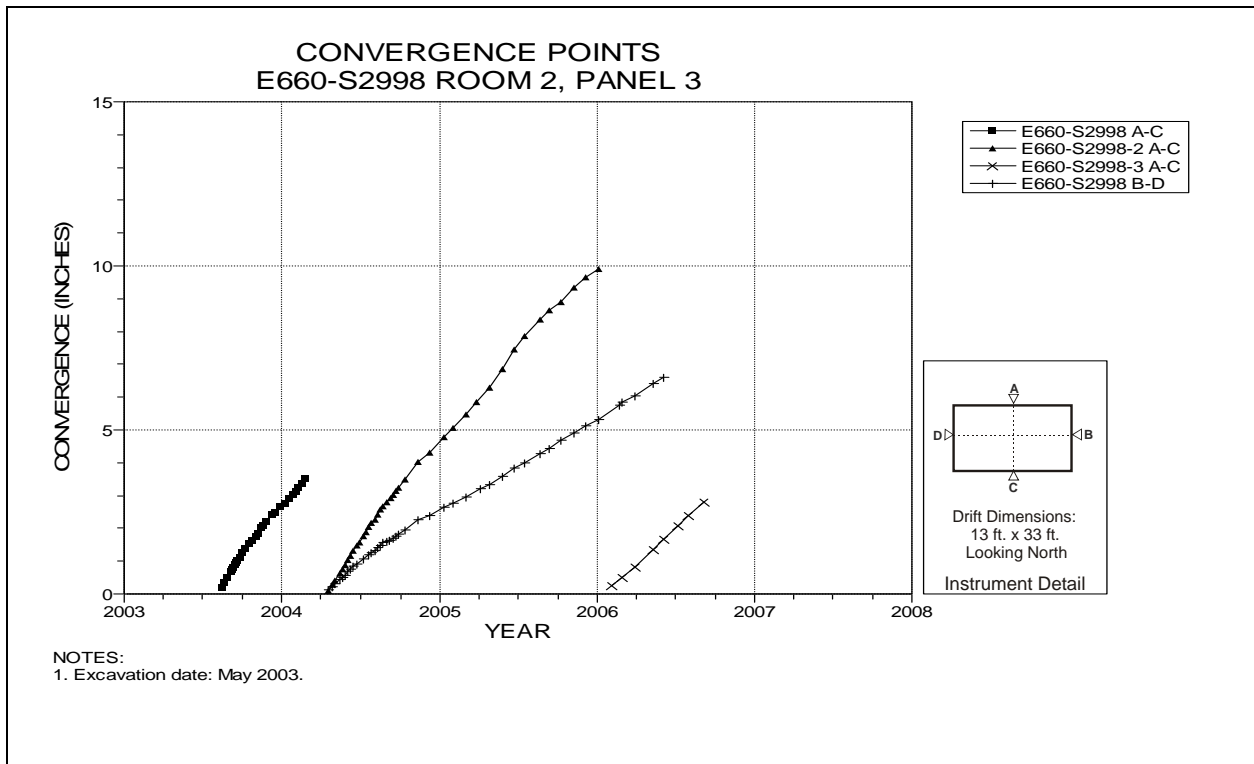


Figure 5-45 Convergence Point Array  
Room 2, Panel 3 at S2998 – All Chords

**Table 5-4**  
**Panel 4 Data Analysis**

**EXTENSOMETERS**

Field Tag	Location	Figure Number	Date of Last Reading	Collar Displacement Relative to Deepest Anchor (inches)	Displacement Rate 2006 to 2007 (in/year)	Displacement Rate 2005 to 2006 <sup>1</sup> (in/year)	Rate Change Percent <sup>1</sup>	Comments
51X-GE-00376	PANEL 4 ROOM 1 CENTER ROOF	5-46	6/25/07	7.270	3.14	3.38	-7%	
51X-GE-00378	PANEL 4 ROOM 2 CENTER ROOF	5-47	6/25/07	4.349	1.84	2.74	-33%	
51X-GE-00383	PANEL 4 ROOM 3 CENTER ROOF	5-48	6/25/07	3.188	2.18	3.41	-36%	
51X-GE-00380	PANEL 4 ROOM 4 CENTER ROOF	5-49	6/25/07	5.251	3.08	3.84	-20%	
51X-GE-00387	PANEL 4 ROOM 5 CENTER ROOF	5-50	6/25/07	2.066	1.88	6.68	-72%	
51X-GE-00381	PANEL 4 ROOM 6 CENTER ROOF	5-51	6/25/07	3.480	1.81	4.12	-56%	
51X-GE-00382	PANEL 4 ROOM 7 CENTER ROOF	5-52	6/25/07	2.595	1.46	3.49	-58%	
51X-GE-00377	S3310 DRIFT-E725 CENTER ROOF	5-53	6/25/07	8.963	4.75	4.60	3%	
51X-GE-00384	S3310 DRIFT-E1125 CENTER ROOF	5-54	6/25/07	2.392	1.76	3.08	-43%	
51X-GE-00386	S3650 DRIFT-E725 CENTER ROOF	5-55	6/25/07	1.809	1.56	2.15	-27%	
51X-GE-00385	S3650 DRIFT-E1125	5-56	6/25/07	2.001	1.88	N/A	N/A	Installed June 2006.

<sup>1</sup> NA indicates insufficient data to compare annualized rates.

**Table 5-4 (Continued)**  
**Panel 4 Data Analysis**

**ROCKBOLT LOAD CELLS**

Field Tag	Location	Figure Number	Date of Initial Reading	Date of Last Reading	Load (kips)	Comments
51X-WG-00301	E520 DRIFT-S3480	5-57	03/14/05	06/06/07	41.2	
51X-WG-00303	E660 DRIFT-S3480	5-58	07/14/05	06/06/07	36.3	
51X-WG-00304	E660 DRIFT-S3350	5-59	07/14/05	06/06/07	37.3	
51X-WG-00307	E790 DRIFT-S3480	5-60	08/24/05	06/07/07	29.2	
51X-WG-00308	E920 DRIFT-S3480	5-61	10/06/05	06/21/07	35.5	
51X-GE-00309	E1050 DRIFT-S3480	5-62	10/26/05	06/21/07	32.1	
51X-WG-00311	E1190 DRIFT-S3480	5-63	01/19/06	06/21/07	43.9	
51X-WG-00312	E1320 DRIFT-S3480	5-64	01/20/06	03/26/07	27.2	
51X-WG-00306	S3310 DRIFT-E727	5-65	08/24/05	06/04/07	21.6	
51X-WG-00305	S3650 DRIFT-E727	5-66	08/24/05	06/06/07	30.8	
51X-WG-00310	S3650 DRIFT-E1125	5-67	11/22/05	06/06/07	30.1	

**Table 5-4 (Continued)  
Panel 4 Data Analysis**

**CONVERGENCE POINTS**

Field Tag	Location	Figure Number	Last Reading 2006 to 2007		Cumulative Displacement (inches)	Closure Rate 2006 to 2007 (in/year)	Closure Rate 2005 to 2006 <sup>1</sup> (in/year)	Rate Change Percent <sup>1</sup>	Comments
			Date	Inches					
S3310-E410 A-C	S3310 DRIFT-E410	5-68	06/04/07	4.983	4.983	1.98	2.86	-31%	
S3310-E520-2 A-C	S3310 DRIFT-E520	5-69	06/04/07	3.788	9.008	3.79	4.53	-16%	
S3310-E586-2 A-C	S3310 DRIFT-E586	5-70	06/04/07	5.028	5.028	5.00	8.47	-41%	
S3310-E660-2 A-C	S3310 DRIFT-E660	5-71	06/04/07	6.054	14.484	5.99	9.39	-36%	
S3310-E727 A-C	S3310 DRIFT-E727	5-72	06/04/07	6.007	6.007	7.50	N/A	N/A	
S3310-E790-2 A-C	S3310 DRIFT-E790	5-73	06/04/07	6.104	14.126	6.06	9.24	-34%	
S3310-E855 A-C	S3310 DRIFT-E855	5-74	06/04/07	4.803	4.803	6.00	N/A	N/A	
S3310-E920-2 A-C	S3310 DRIFT-E920	5-75	06/04/07	5.781	16.652	5.80	7.93	-27%	
S3310-E986-2 A-C	S3310 DRIFT-E985	5-76	06/04/07	6.368	6.848	4.74	8.82	-46%	
S3310-E1050-2 A-C	S3310 DRIFT-E1050	5-77	06/07/07	6.919	7.425	5.17	9.51	-46%	
S3310-E1120 A-C	S3310 DRIFT-E1120	5-78	04/09/07	2.965	2.965	4.58	N/A	N/A	
S3310-E1190-2 A-C	S3310 DRIFT-E1190	5-79	04/09/07	6.095	6.207	5.24	8.96	-42%	
S3310-E1255-2 A-C	S3310 DRIFT-E1255	5-80	02/13/07	4.809	4.917	4.20	7.45	-44%	
S3310-E1320-2 A-C	S3310 DRIFT-E1320	5-81	02/13/07	3.258	3.334	3.40	5.05	-33%	
E520-S3395-2 A-C	E520 DRIFT-S3395	5-82	06/07/07	4.973	13.588	4.96	6.65	-25%	
E520-S3395 B-D	E520 DRIFT-S3395	5-82	06/07/07	9.717	9.717	3.19	4.46	-28%	
E520-S3480-2 A-C	E520 DRIFT-S3480	5-83	06/07/07	5.411	14.411	5.40	7.31	-26%	
E520-S3480 B-D	E520 DRIFT-S3480	5-83	06/07/07	10.659	10.659	3.65	4.84	-25%	
E520-S3565-2 A-C	E520 DRIFT-S3565	5-84	06/07/07	4.570	12.871	4.57	6.81	-33%	
E520-S3565 B-D	E520 DRIFT-S3565	5-84	06/07/07	10.303	10.303	3.53	4.67	-24%	
E660-S3395-2 A-C	E660 DRIFT-S3395	5-85	6/7/2007	3.544	9.879	4.14	6.98	-41%	
E660-S3480-2 A-C	E660 DRIFT-S3480	5-86	06/07/07	4.817	11.411	4.77	7.41	-36%	
E660-S3565-2 A-C	E660 DRIFT-S3565	5-87	06/07/07	3.962	7.970	3.93	6.21	-37%	
E790-S3395-2 A-C	E790 DRIFT-S3395	5-88	06/07/07	4.698	9.903	4.66	7.49	-38%	
E790-S3480-2 A-C	E790 DRIFT-S3480	5-89	06/07/07	5.164	10.488	5.12	8.11	-37%	
E790-S3565-2 A-C	E790 DRIFT-S3565	5-90	06/07/07	4.256	9.050	4.23	6.68	-37%	
E920-S3395-2 A-C	E920 DRIFT-S3395	5-91	06/18/07	5.586	8.547	4.34	7.77	-44%	
E920-S3480-2 A-C	E920 DRIFT-S3480	5-92	06/18/07	8.002	11.189	6.45	10.00	-36%	

<sup>1</sup> NA indicates insufficient data to compare annualized rates. These instruments were not installed during the 2005-2006 reporting period.

**Table 5-4 (Continued)**  
**Panel 4 Data Analysis**

**CONVERGENCE POINTS (Continued)**

Field Tag	Location	Figure Number	Last Reading 2006 to 2007		Cumulative Displacement (inches)	Closure Rate 2006 to 2007 (in/year)	Closure Rate 2005 to 2006 <sup>1</sup> (in/year)	Rate Change Percent <sup>1</sup>	Comments
			Date	Inches					
E920-S3565-2 A-C	E920 DRIFT-S3565	5-93	06/18/07	5.418	8.246	4.21	7.54	-44%	
E1050-S3395-2 A-C	E1050 DRIFT-S3395	5-94	06/21/07	4.629	9.298	4.40	6.46	-32%	
E1050-S3480-2 A-C	E1050 DRIFT-S3480	5-95	06/21/07	4.785	9.397	4.56	6.76	-33%	
E1050-S3565-2 A-C	E1050 DRIFT-S3565	5-96	06/21/07	4.090	8.348	3.88	5.95	-35%	
E1190-S3395-2 A-C	E1190 DRIFT-S3395	5-97	06/07/07	4.904	6.319	3.60	6.71	-46%	
E1190-S3480-2 A-C	E1190 DRIFT-S3480	5-98	06/21/07	5.795	7.212	4.19	7.47	-44%	
E1190-S3565-2 A-C	E1190 DRIFT-S3565	5-99	06/21/07	4.585	5.968	3.25	6.20	-48%	
E1320-S3395-2 A-C	E1320 DRIFT-S3395	5-100	02/28/07	4.681	5.543	4.01	6.85	-41%	
E1320-S3480-2 A-C	E1320 DRIFT-S3480	5-101	03/26/07	5.095	5.972	4.02	7.22	-44%	
E1320-S3565-2 A-C	E1320 DRIFT-S3565	5-102	04/10/07	4.832	5.501	3.70	6.63	-44%	
S3650-E520-2 A-C	S3650 DRIFT-E520	5-103	06/07/07	3.316	6.439	3.39	4.87	-30%	
S3650-E586-3 A-C	S3650 DRIFT-E586	5-104	06/07/07	4.099	7.234	4.11	5.55	-26%	
S3650-E660-2 A-C	S3650 DRIFT-E660	5-105	06/07/07	7.357	9.507	4.81	7.40	-35%	
S3650-E725 A-C	S3650 DRIFT-E725	5-106	06/07/07	3.406	3.406	4.00	N/A	N/A	
S3650-E790-2 A-C	S3650 DRIFT-E790	5-107	06/07/07	7.366	9.981	4.74	7.73	-39%	
S3650-E855 A-C	S3650 DRIFT-E855	5-108	06/07/07	4.025	4.025	4.73	N/A	N/A	
S3650-E920 A-C	S3650 DRIFT-E920	5-109	06/07/07	7.209	7.209	4.87	8.48	-43%	
S3650-E986 A-C	S3650 DRIFT-E986	5-110	06/07/07	7.353	7.353	4.99	8.56	-42%	
S3650-E1050 A-C	S3650 DRIFT-E1050	5-111	06/07/07	7.332	7.332	4.95	8.63	-43%	
S3650-E1120 A-C	S3650 DRIFT-E1120	5-112	06/07/07	3.396	3.396	3.99	N/A	N/A	
S3650-E1190 A-C	S3650 DRIFT-E1190	5-113	06/07/07	5.607	5.607	3.71	7.32	-49%	
S3650-E1255 A-C	S3650 DRIFT-E1255	5-114	04/10/07	4.804	4.804	3.67	6.67	-45%	
S3650-E1320 A-C	S3650 DRIFT-E1320	5-115	04/10/07	3.451	3.451	2.62	4.70	-44%	

<sup>1</sup> NA indicates insufficient data to compare annualized rates. These instruments were not installed during the 2005-2006 reporting period.

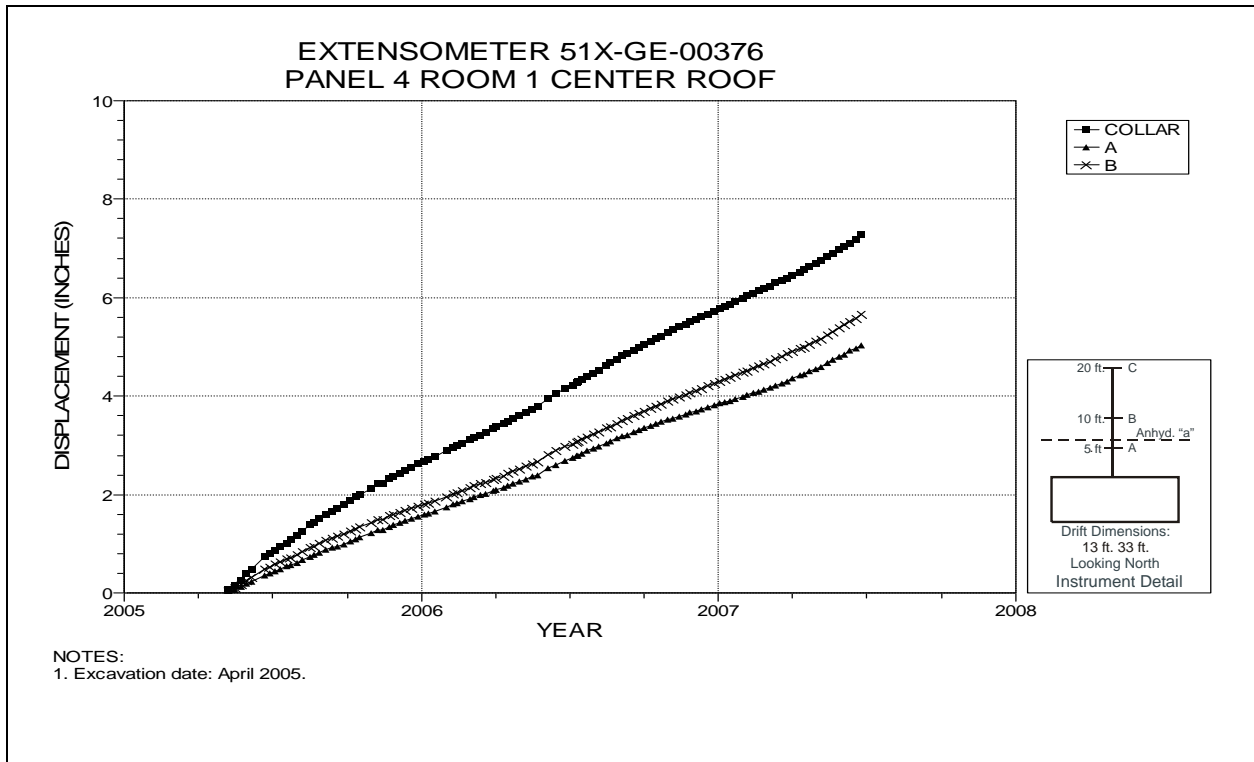


Figure 5-46 Extensometer 51X-GE-00376  
Room 1, Panel 4 – Room Center – Roof

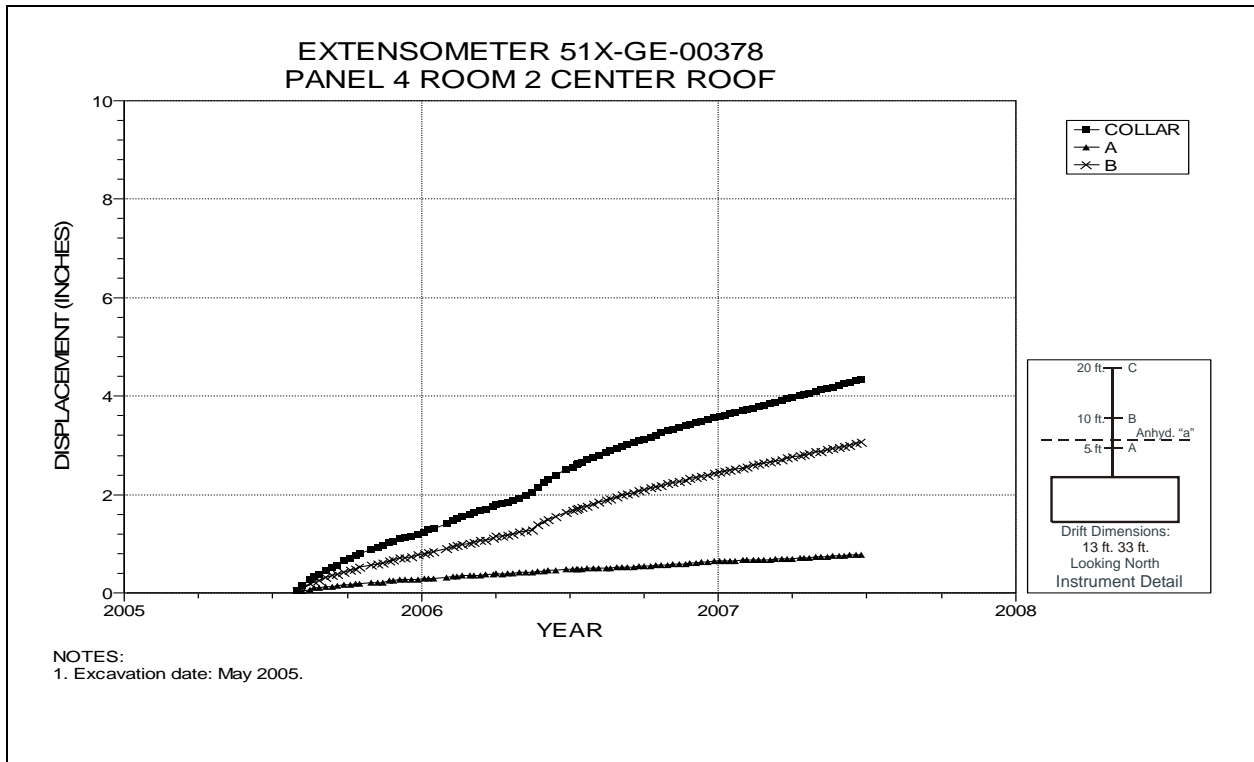


Figure 5-47 Extensometer 51X-GE-00378  
Room 2, Panel 4 – Room Center – Roof



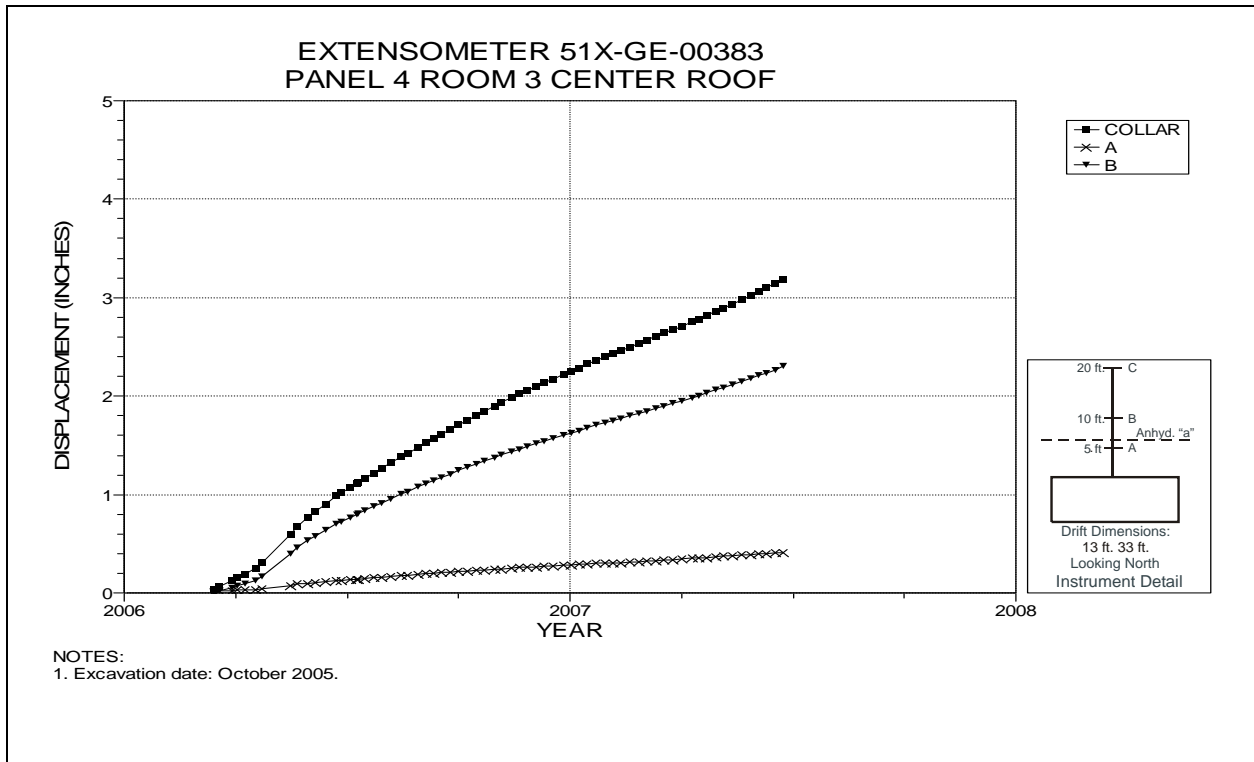


Figure 5-48 Extensometer 51X-GE-00383  
Room 3, Panel 4 – Room Center – Roof

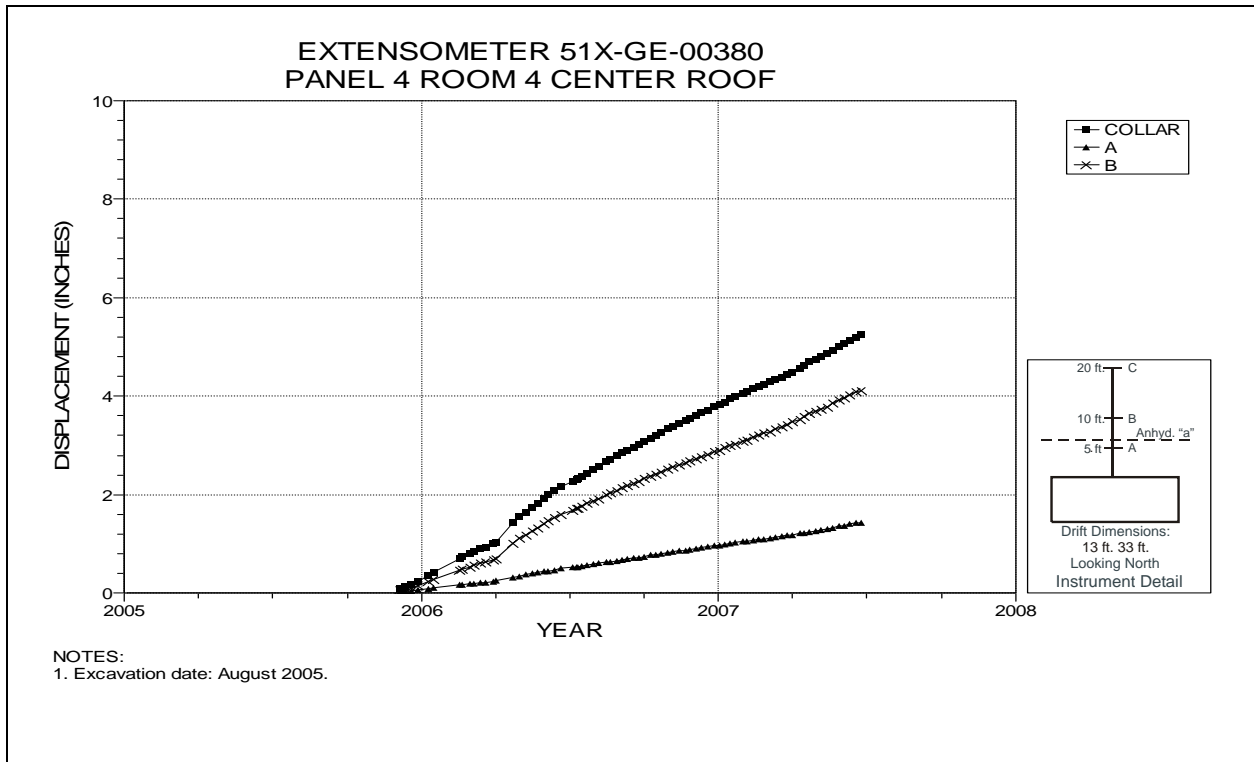


Figure 5-49 Extensometer 51X-GE-00380  
Room 4, Panel 4 – Room Center – Roof

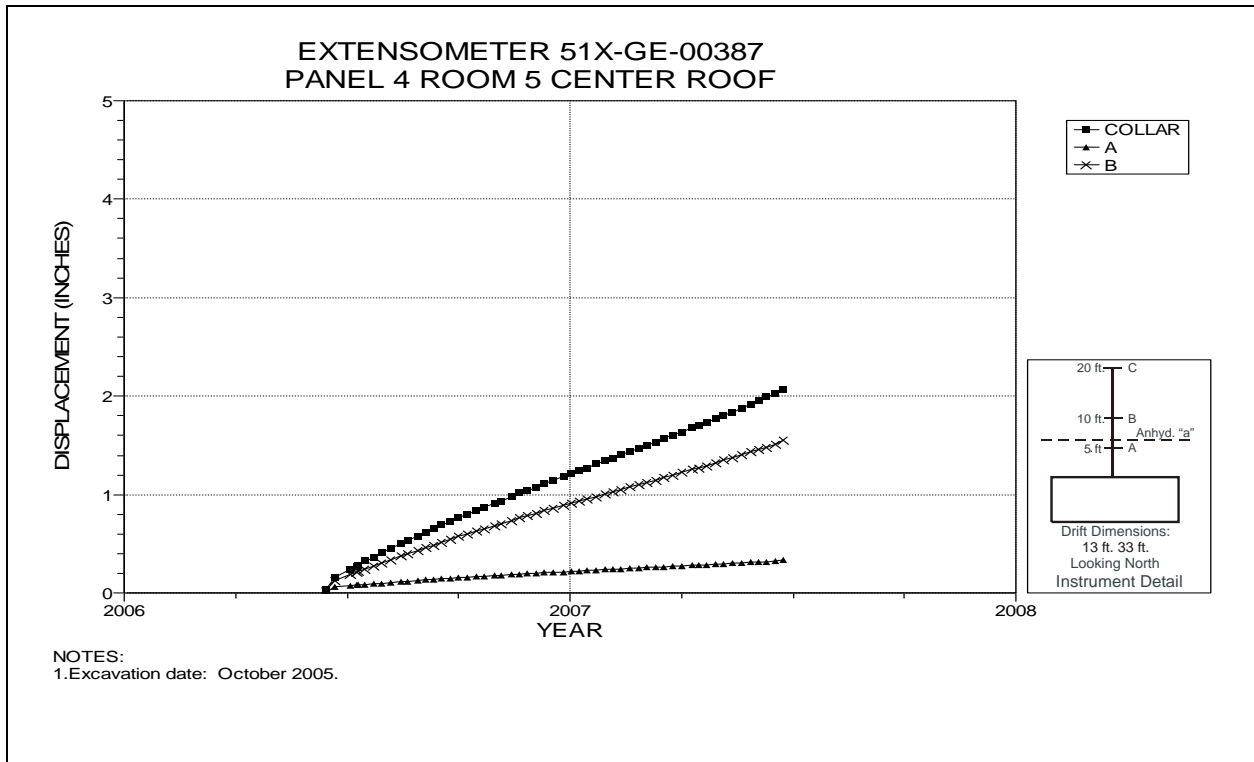


Figure 5-50 Extensometer 51X-GE-00387  
Room 5, Panel 4 – Room Center – Roof

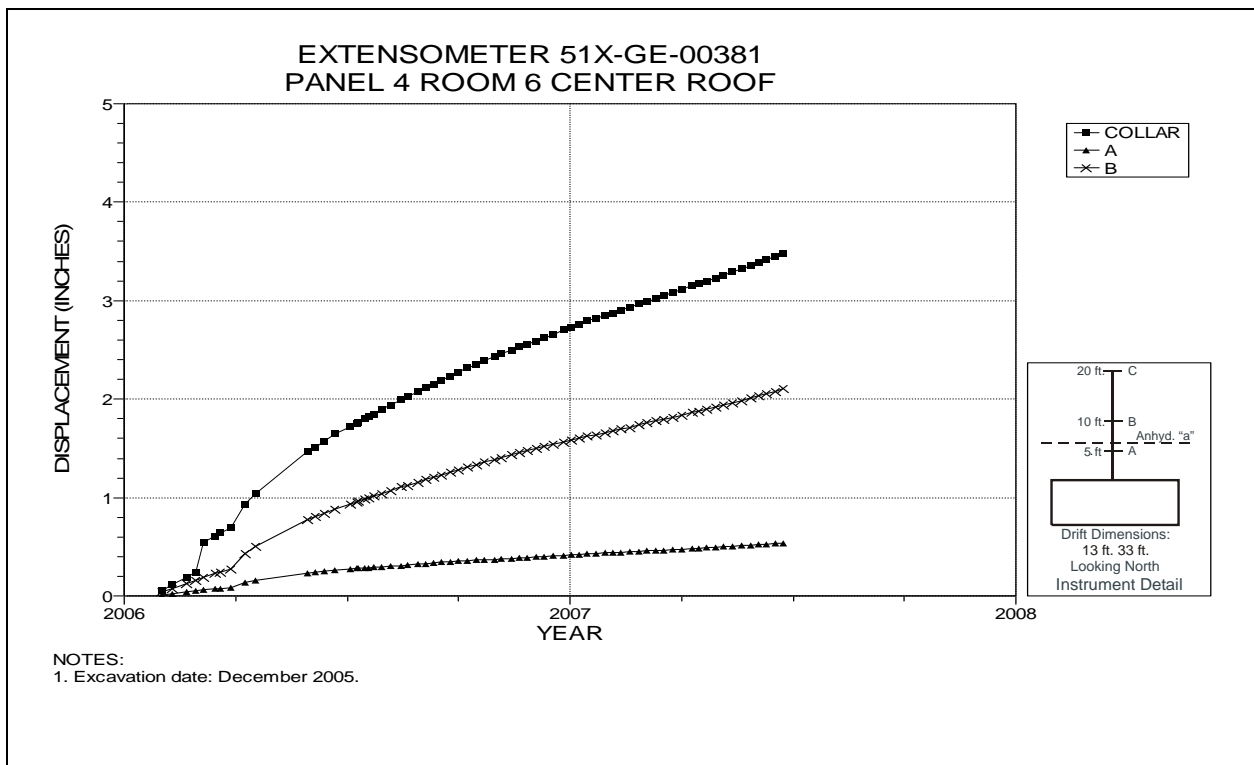


Figure 5-51 Extensometer 51X-GE-00381  
Room 6, Panel 4 – Room Center – Roof

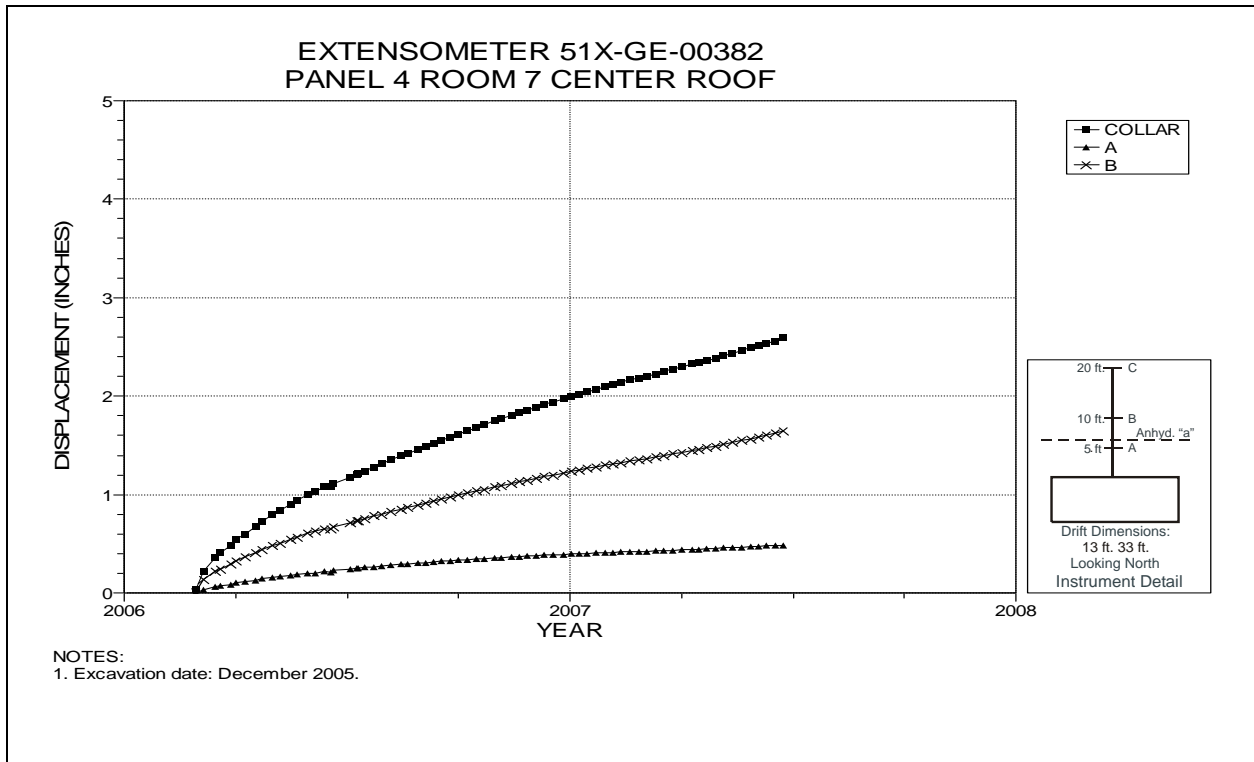


Figure 5-52 Extensometer 51X-GE-00382  
Room 7, Panel 4 – Room Center – Roof

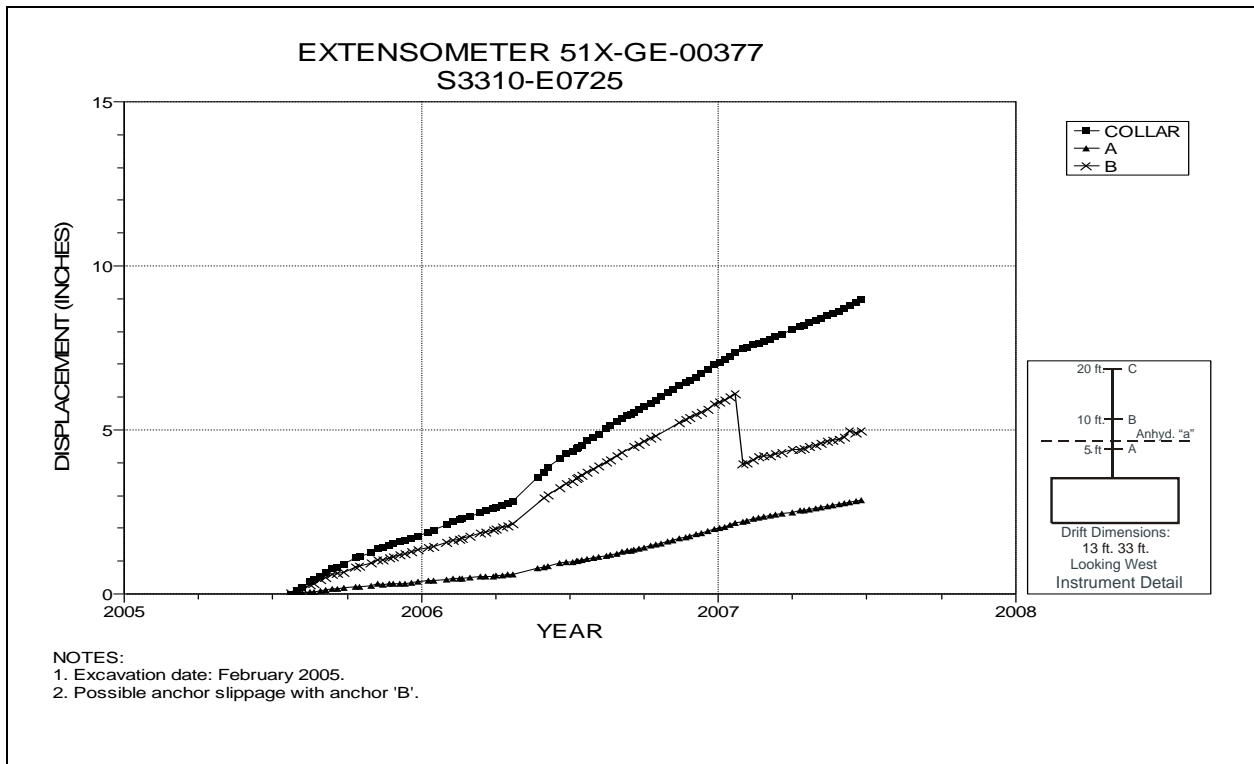


Figure 5-53 Extensometer 51X-GE-00377  
S3310 Drift-E725 – Roof

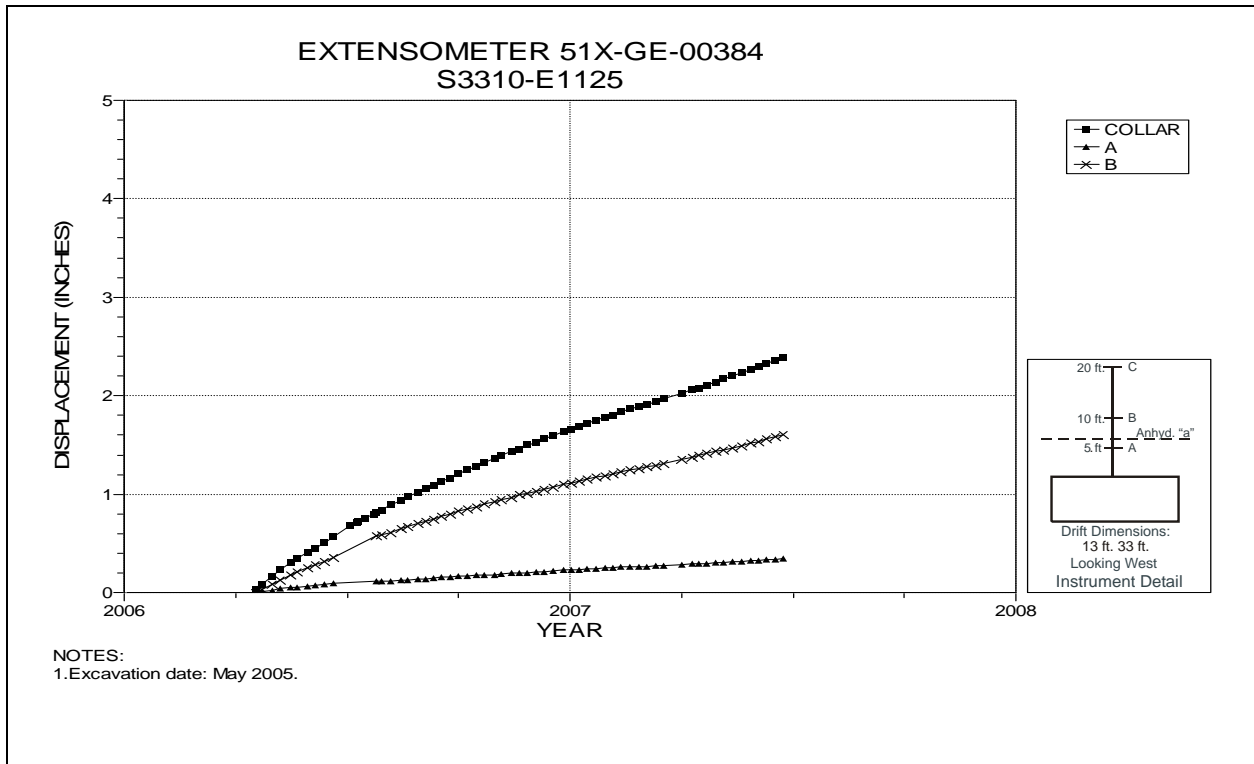


Figure 5-54 Extensometer 51X-GE-00384  
S3310 Drift-E1125 – Roof

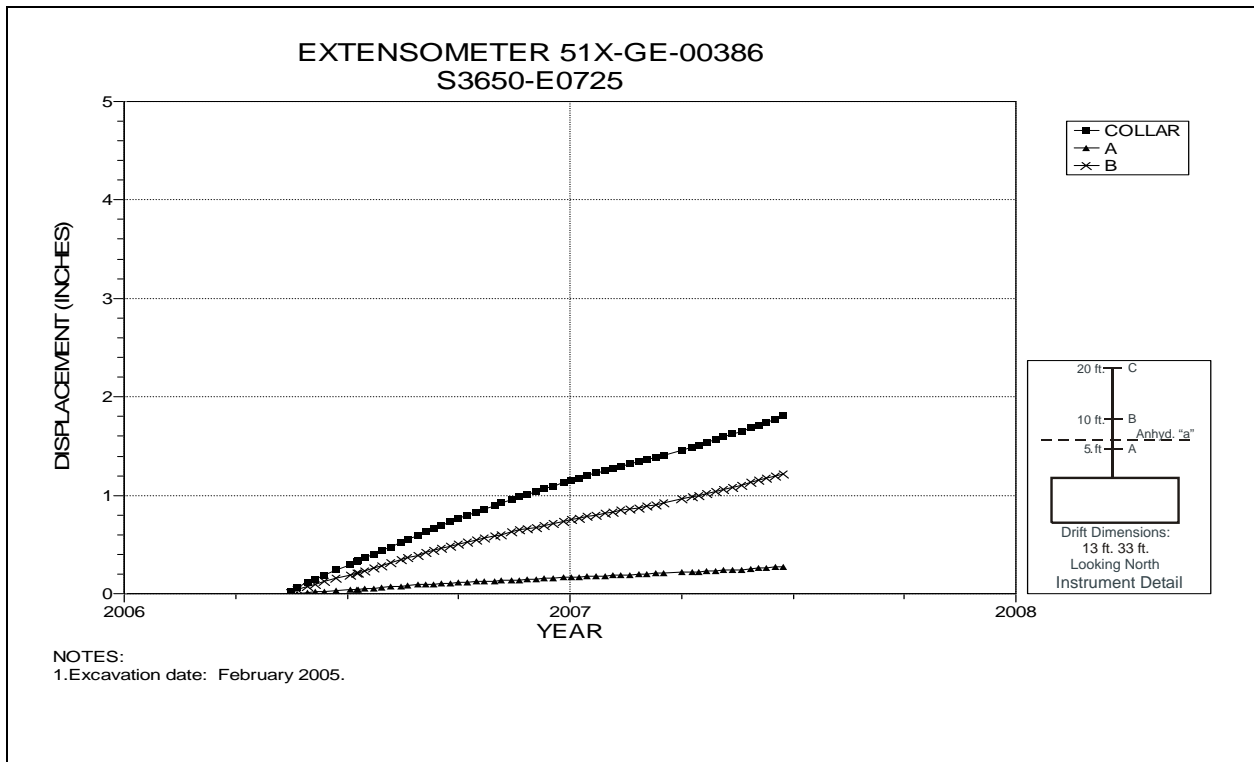


Figure 5-55 Extensometer 51X-GE-00386  
S3650 Drift-E725 – Roof

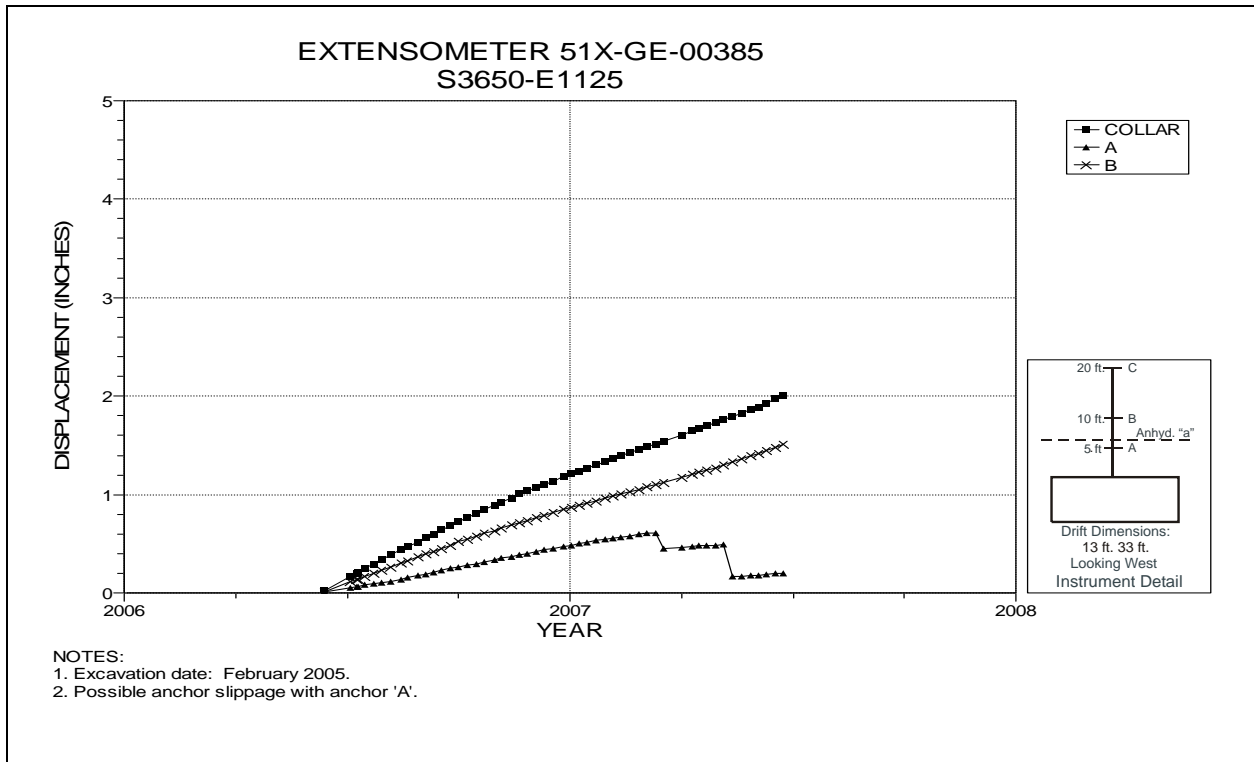


Figure 5-56 Extensometer 51X-GE-00385  
S3650 Drift-E1125 – Roof

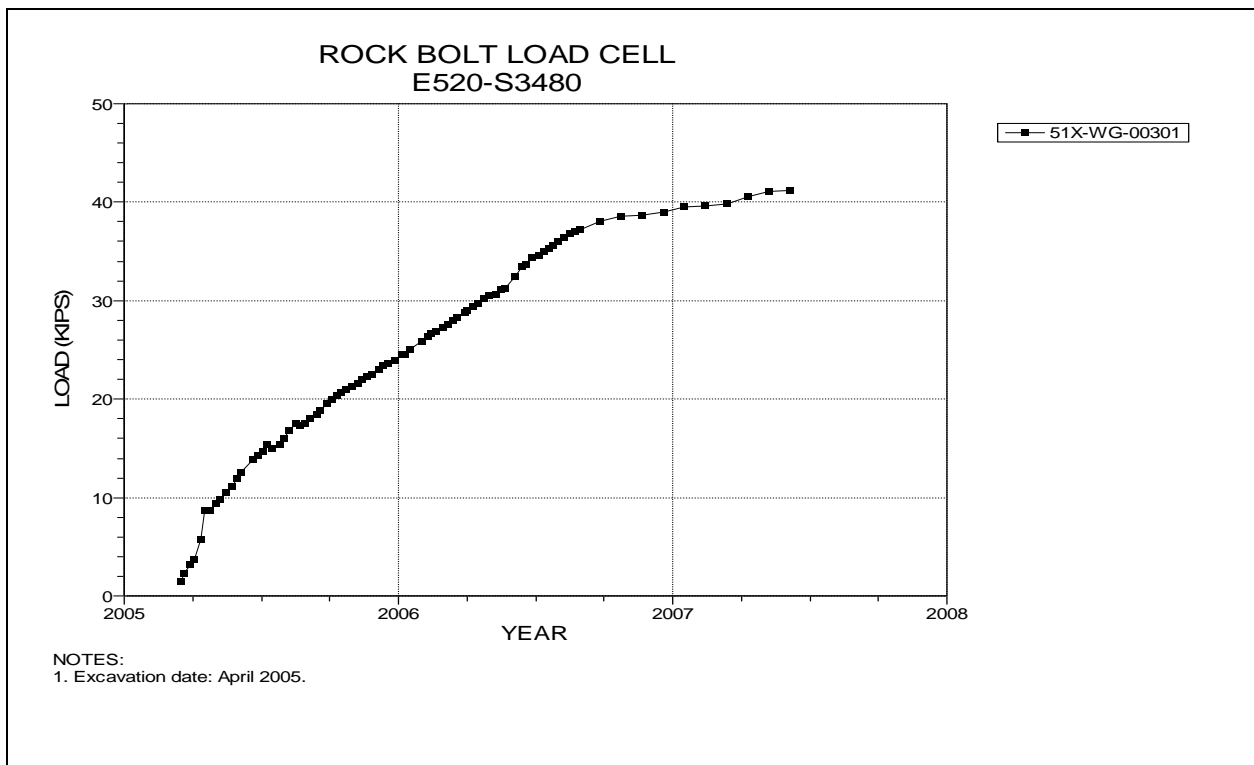


Figure 5-57 Rock Bolt Load Cell  
Room 1, Panel 4

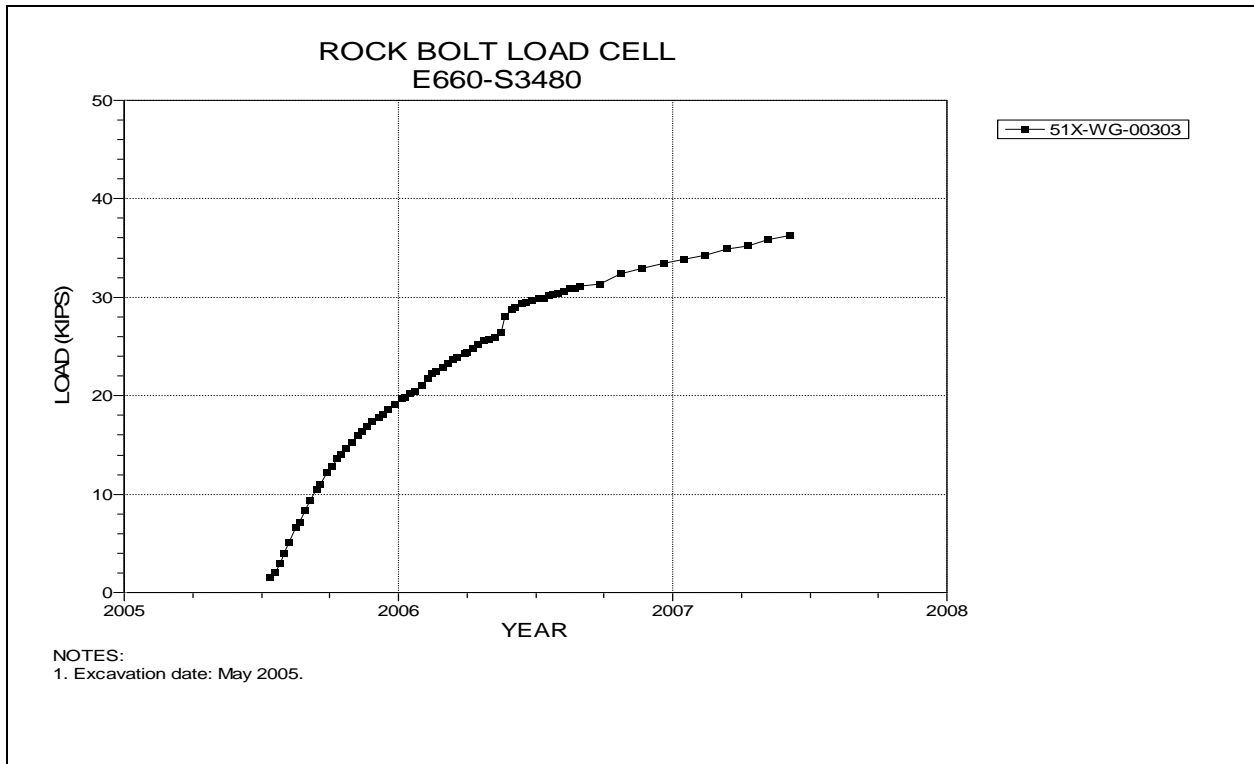


Figure 5-58 Rock Bolt Load Cell  
Room 2, Panel 4

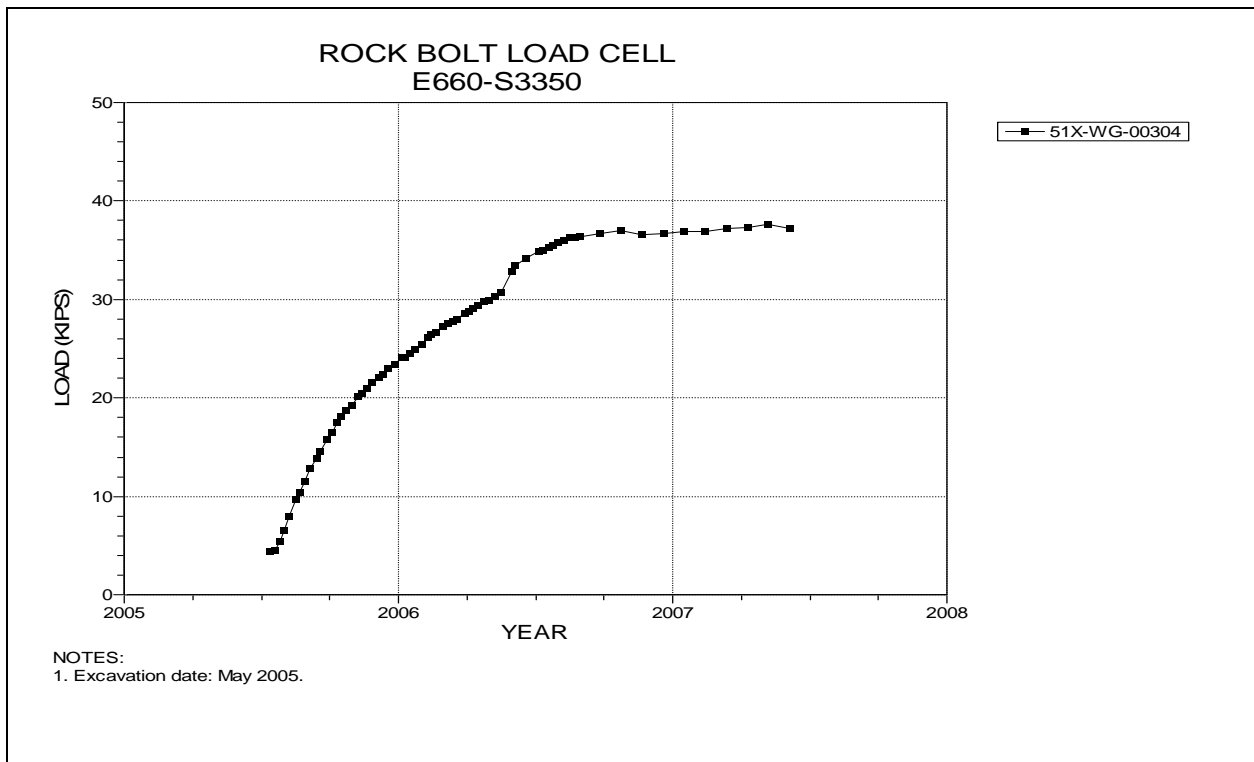


Figure 5-59 Rock Bolt Load Cell  
Room 2, Panel 4

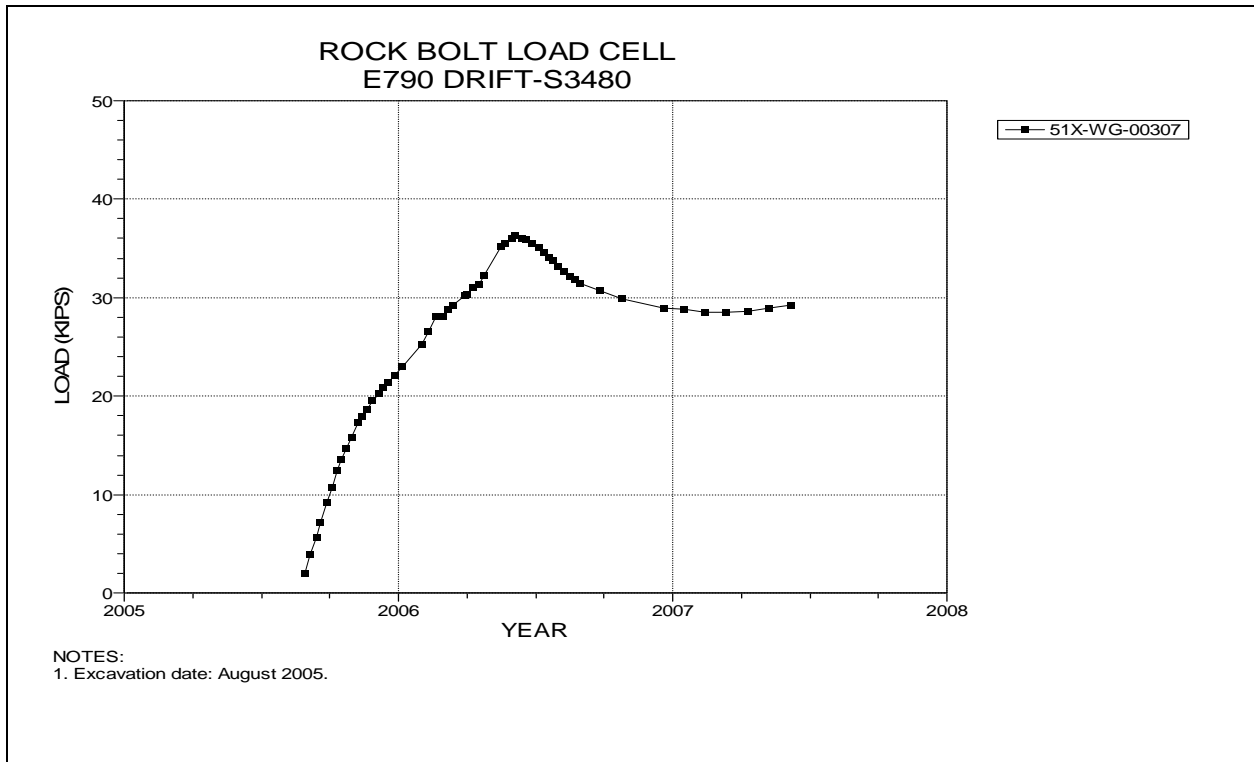


Figure 5-60 Rock Bolt Load Cell  
Room 3, Panel 4

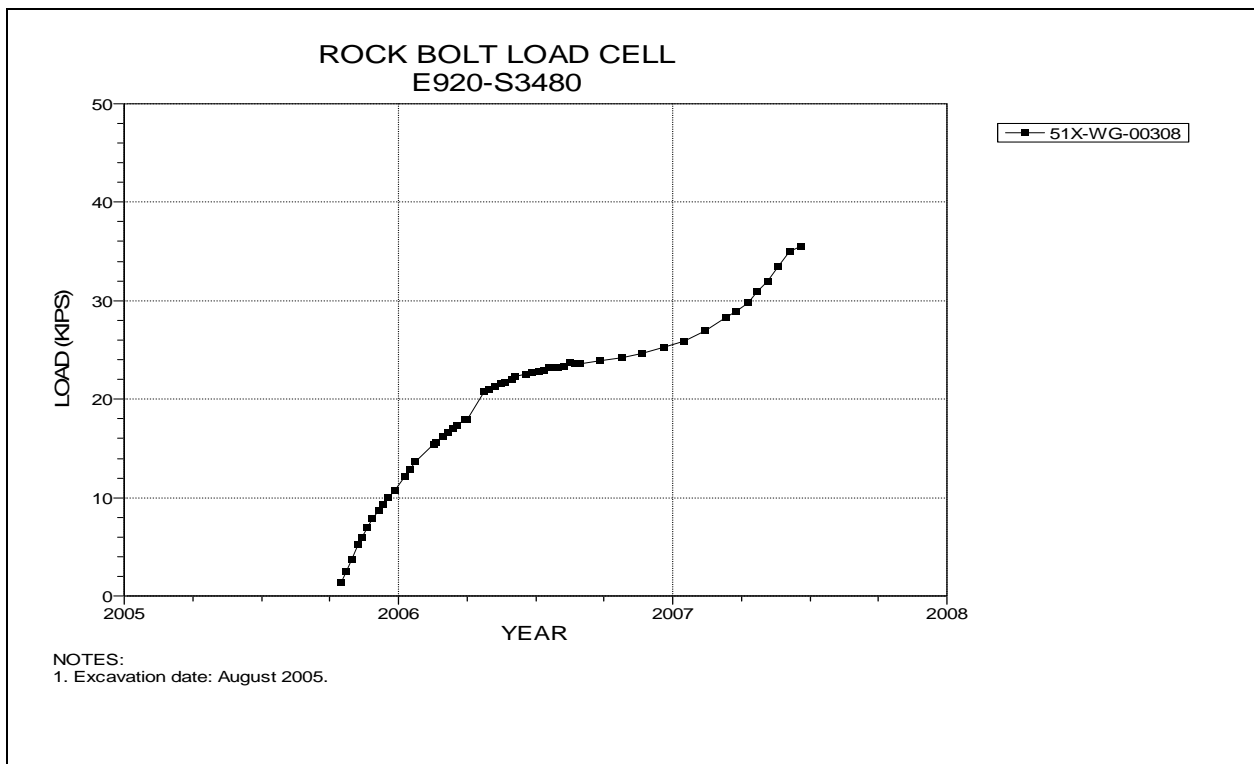


Figure 5-61 Rock Bolt Load Cell  
Room 4, Panel 4

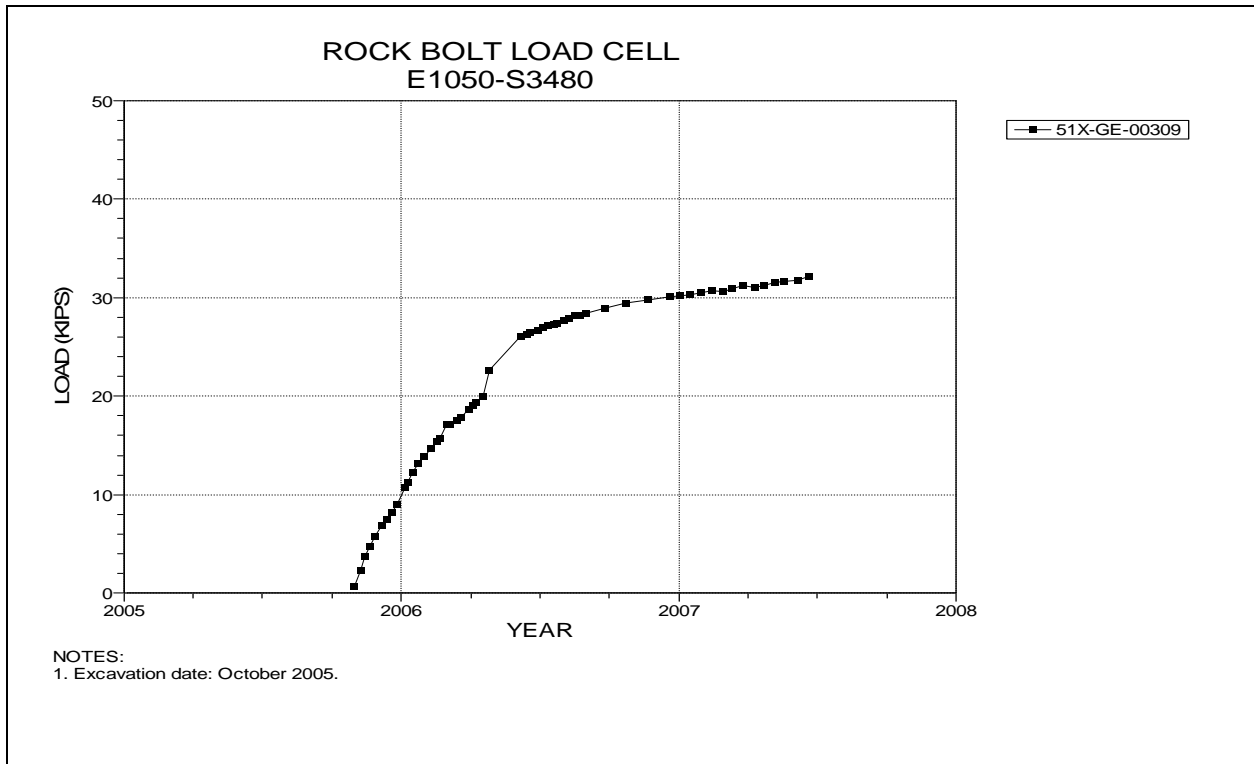


Figure 5-62 Rock Bolt Load Cell  
Room 5, Panel 4

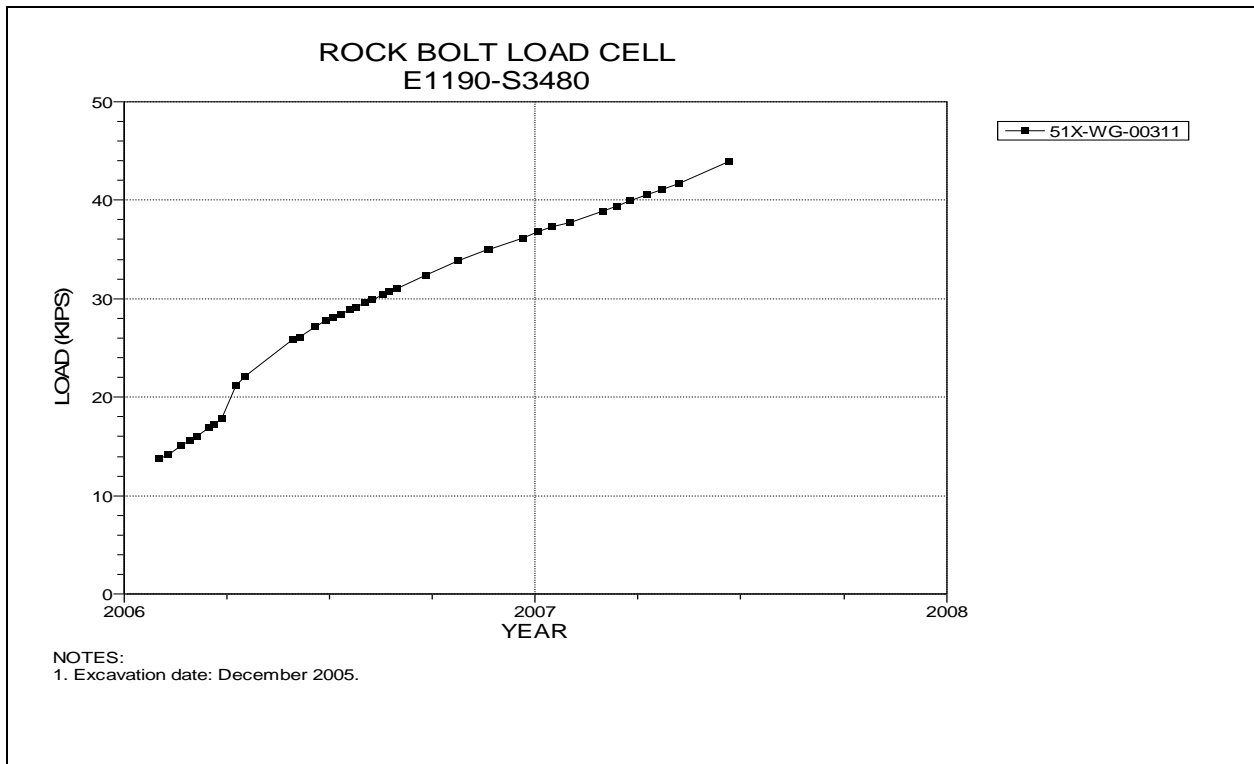


Figure 5-63 Rock Bolt Load Cell  
Room 6, Panel 4



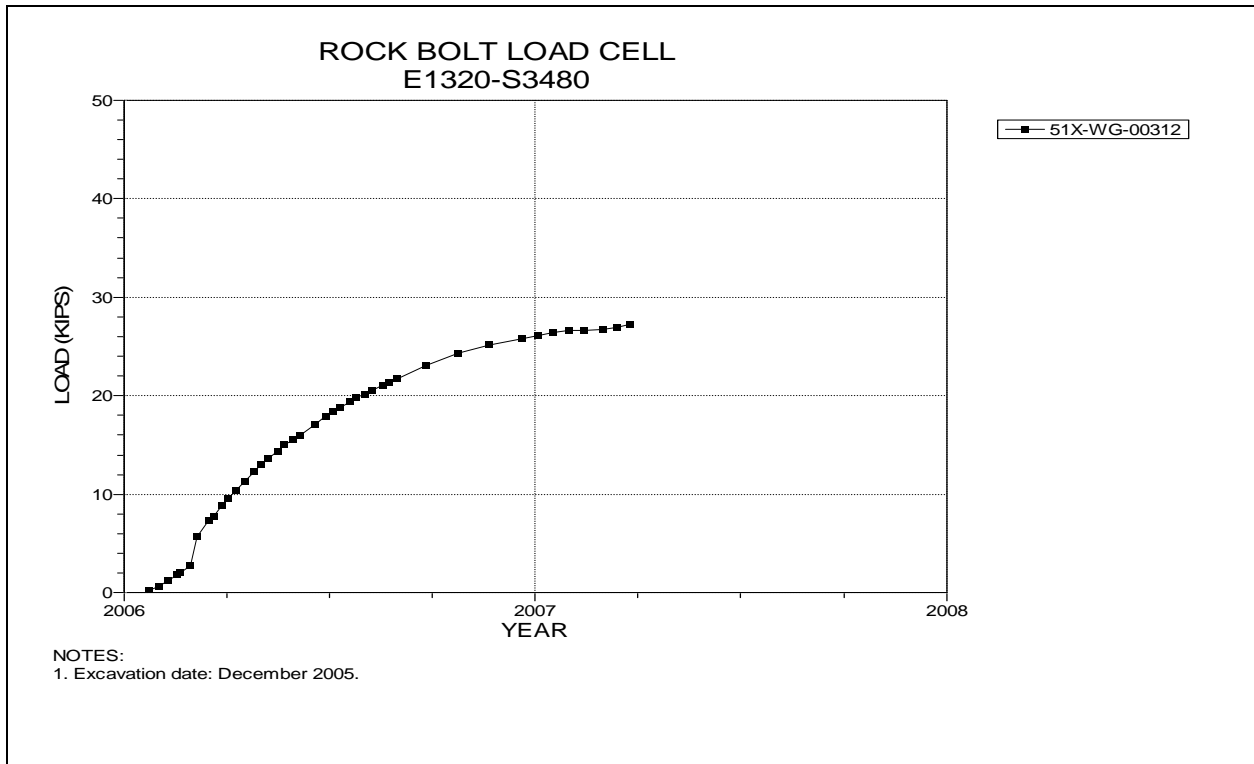


Figure 5-64 Rock Bolt Load Cell  
Room 7, Panel 4

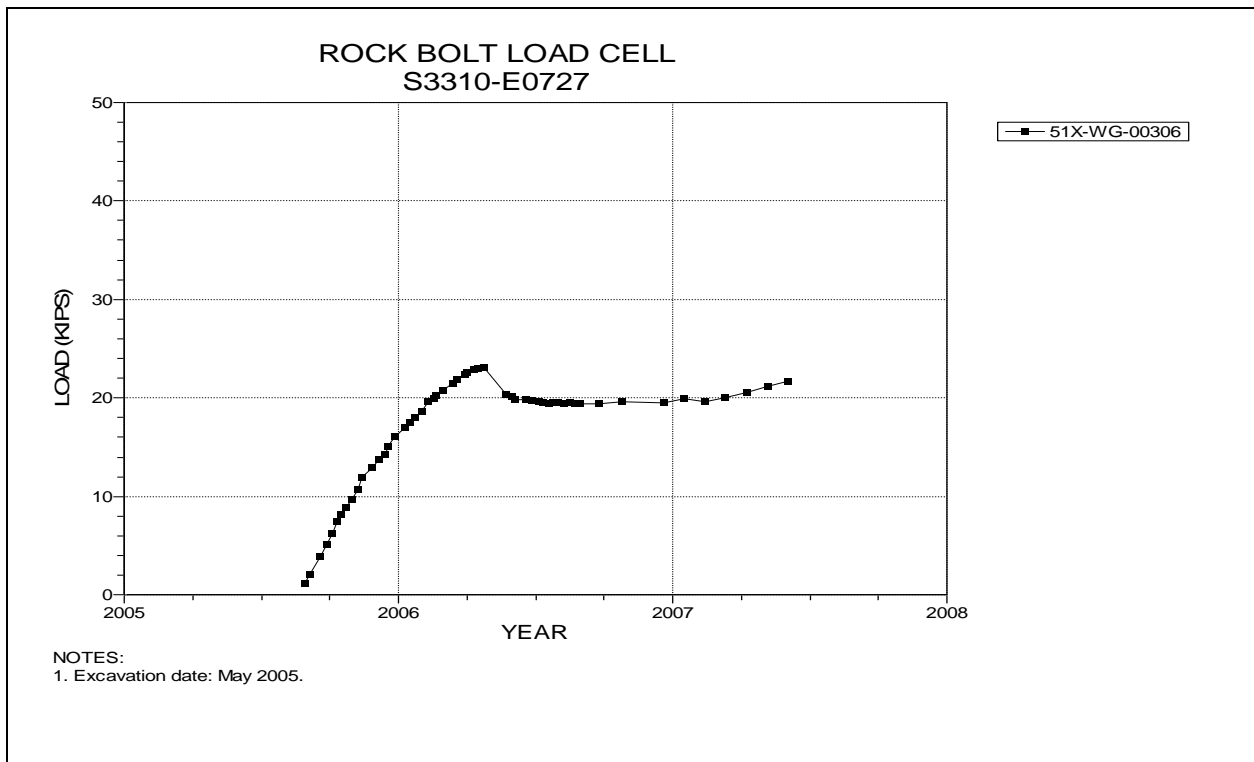


Figure 5-65 Rock Bolt Load Cell  
S3310 Drift-E727

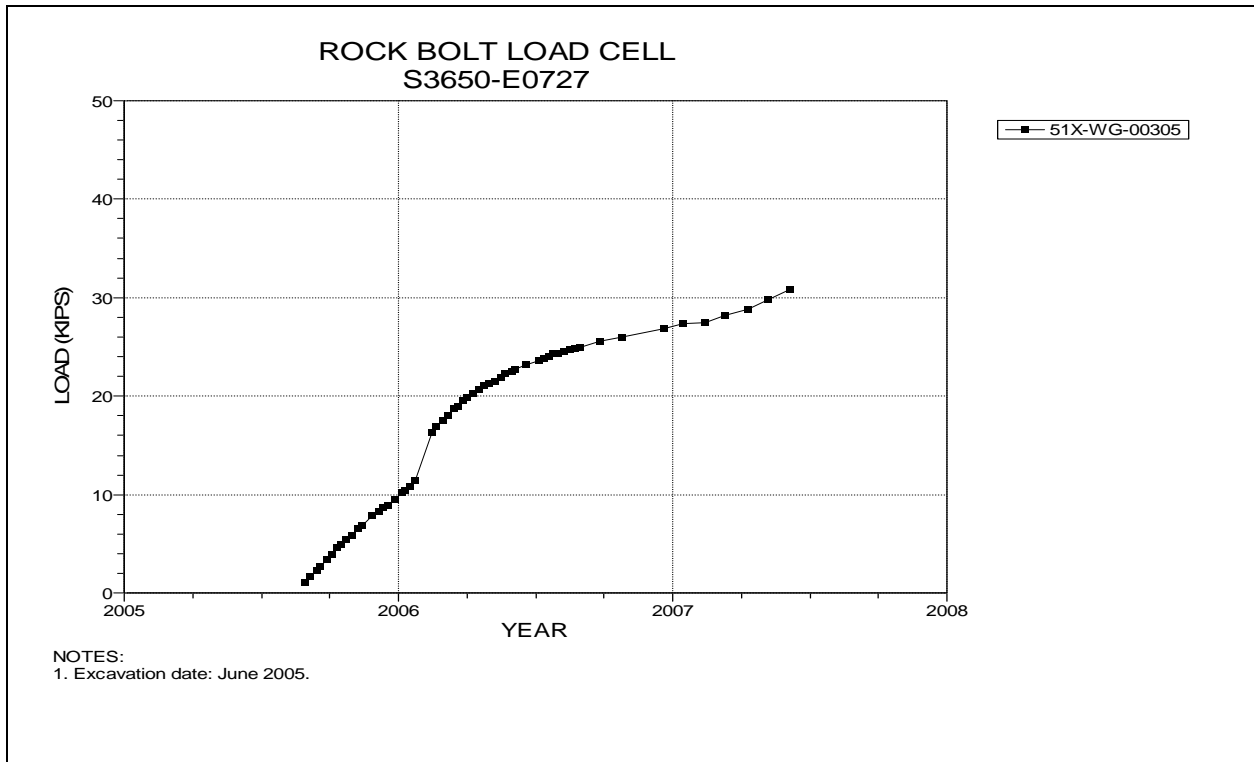


Figure 5-66 Rock Bolt Load Cell  
S3650 Drift-E727

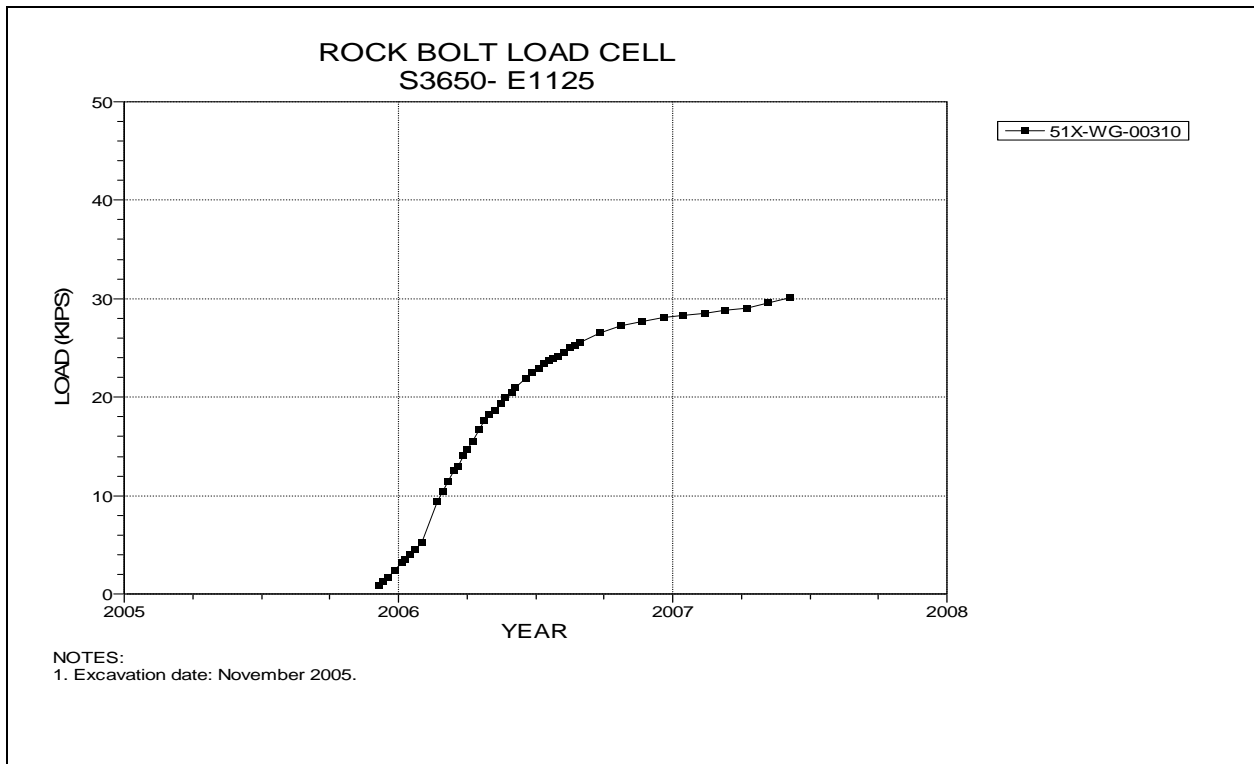


Figure 5-67 Rock Bolt Load Cell  
S3650 Drift-E1125

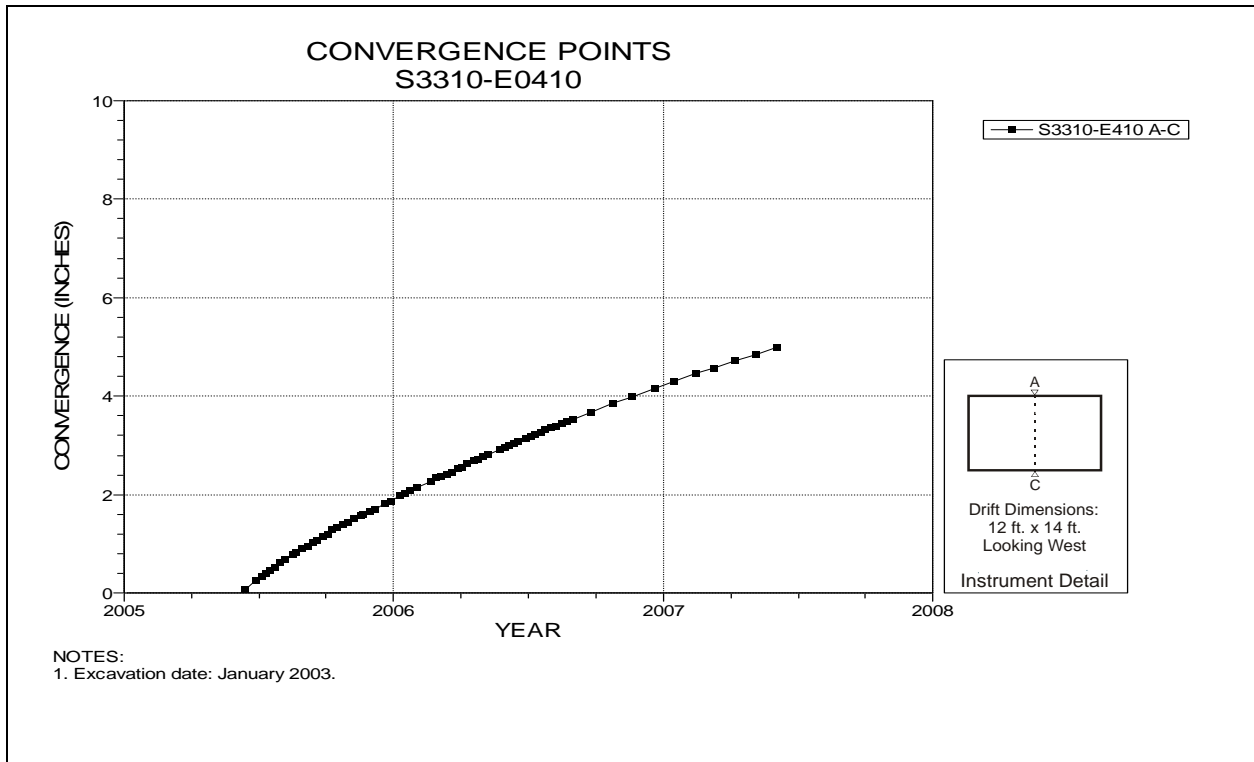


Figure 5-68 Convergence Point Array  
S3310 Drift at E410 – Roof to Floor

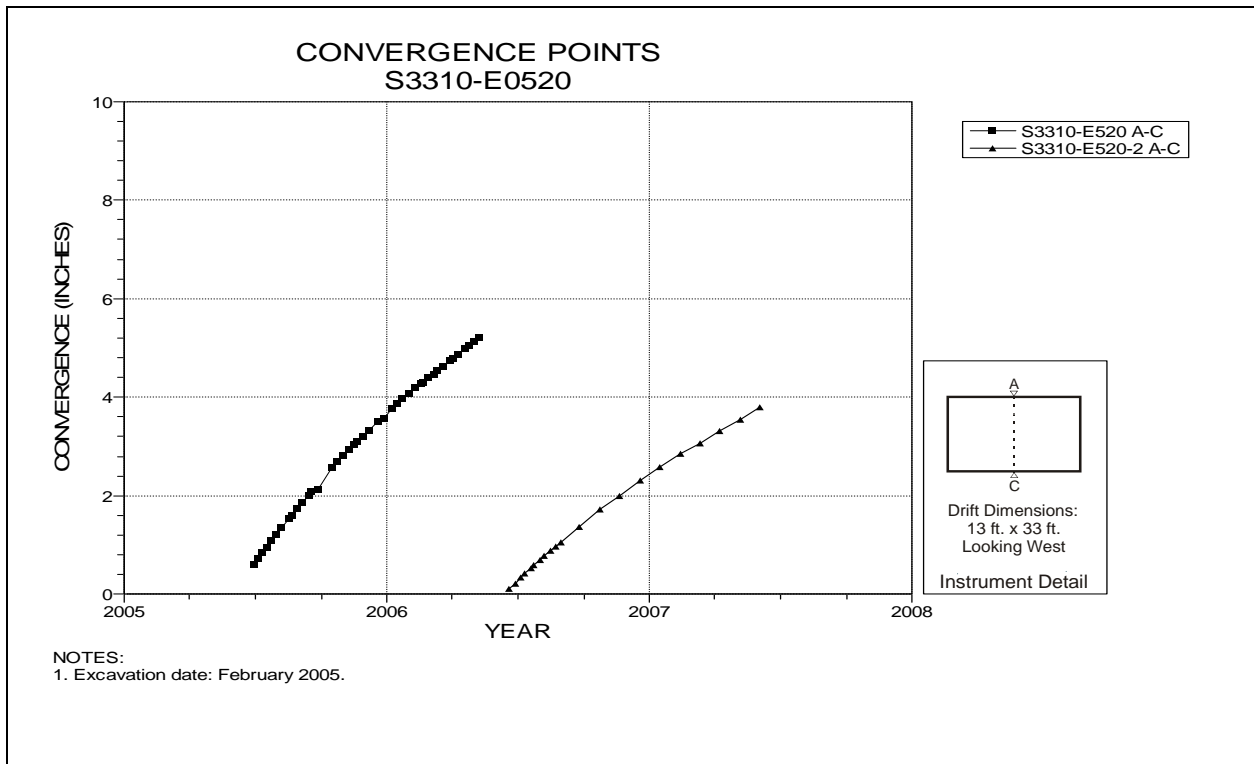


Figure 5-69 Convergence Point Array  
S3310 Drift at E520 Drift Intersection (Room 1, Panel 4) – Roof to Floor

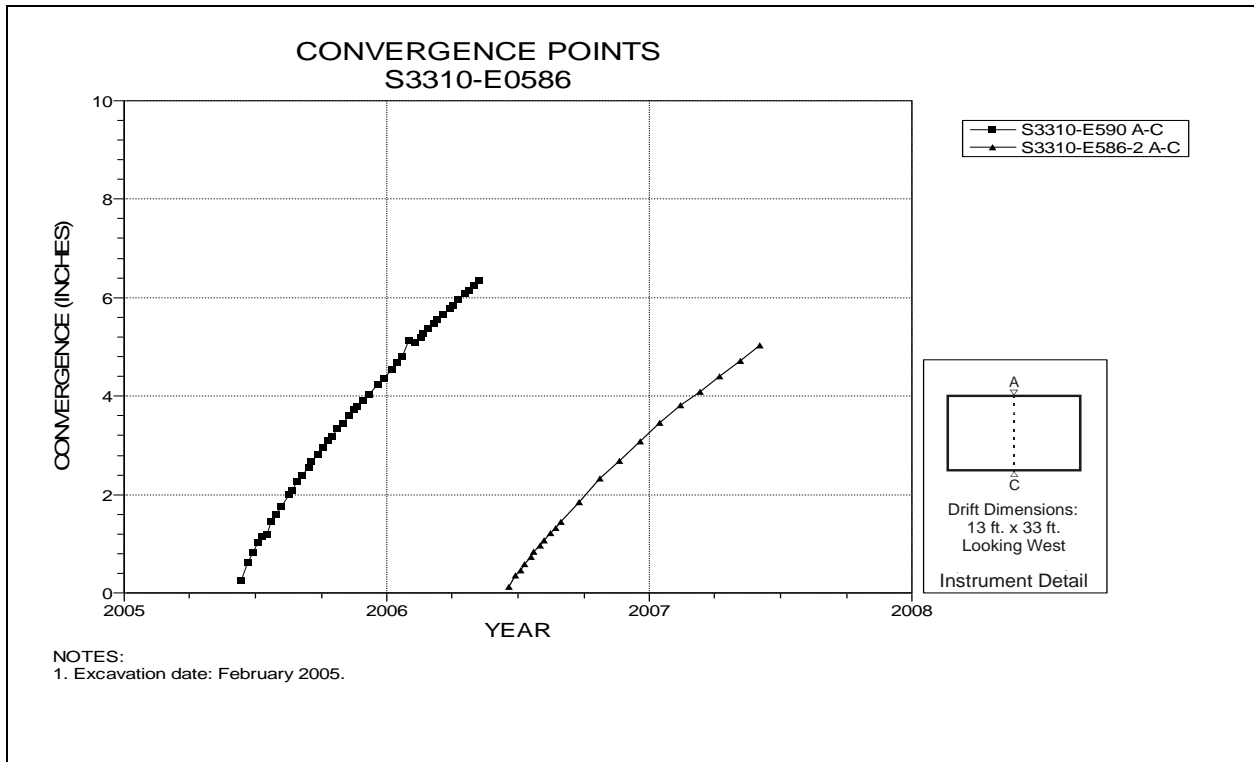


Figure 5-70 Convergence Point Array  
S3310 Drift at E586 – Roof to Floor

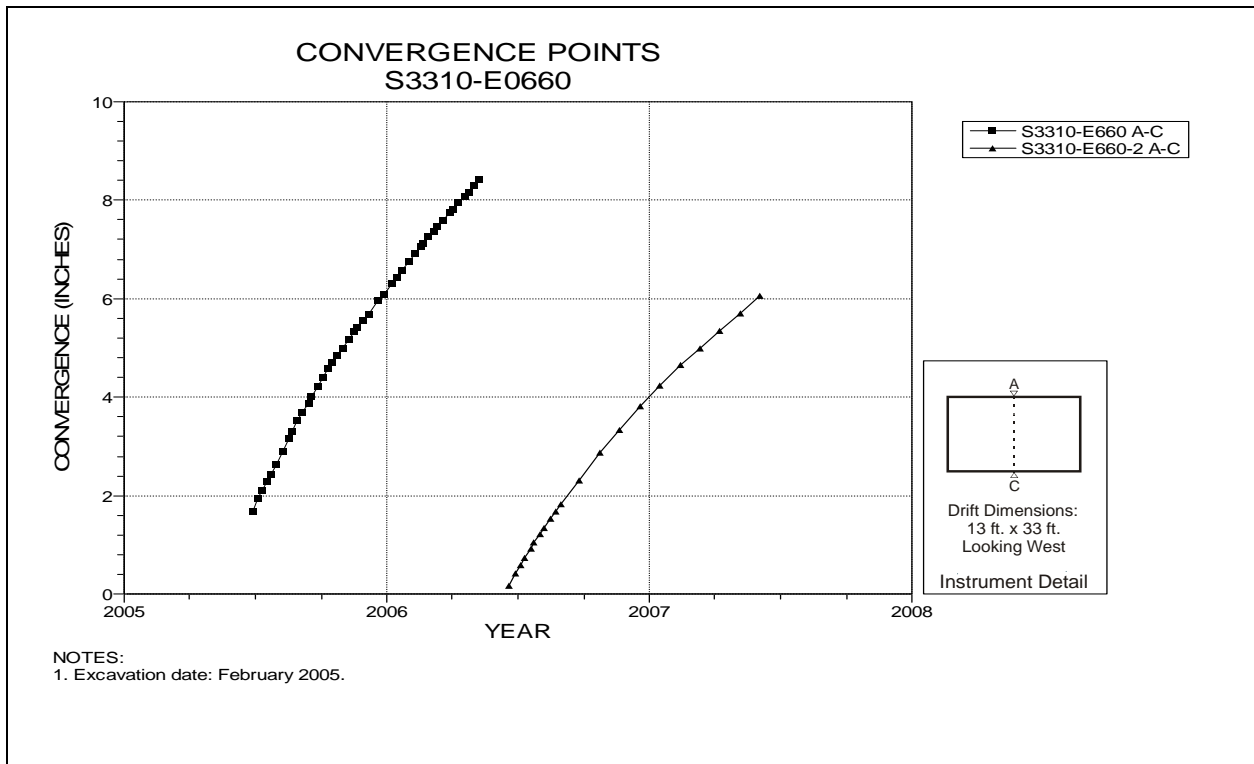


Figure 5-71 Convergence Point Array  
S3310 Drift at E660 Drift Intersection (Room 2, Panel 4) – Roof to Floor

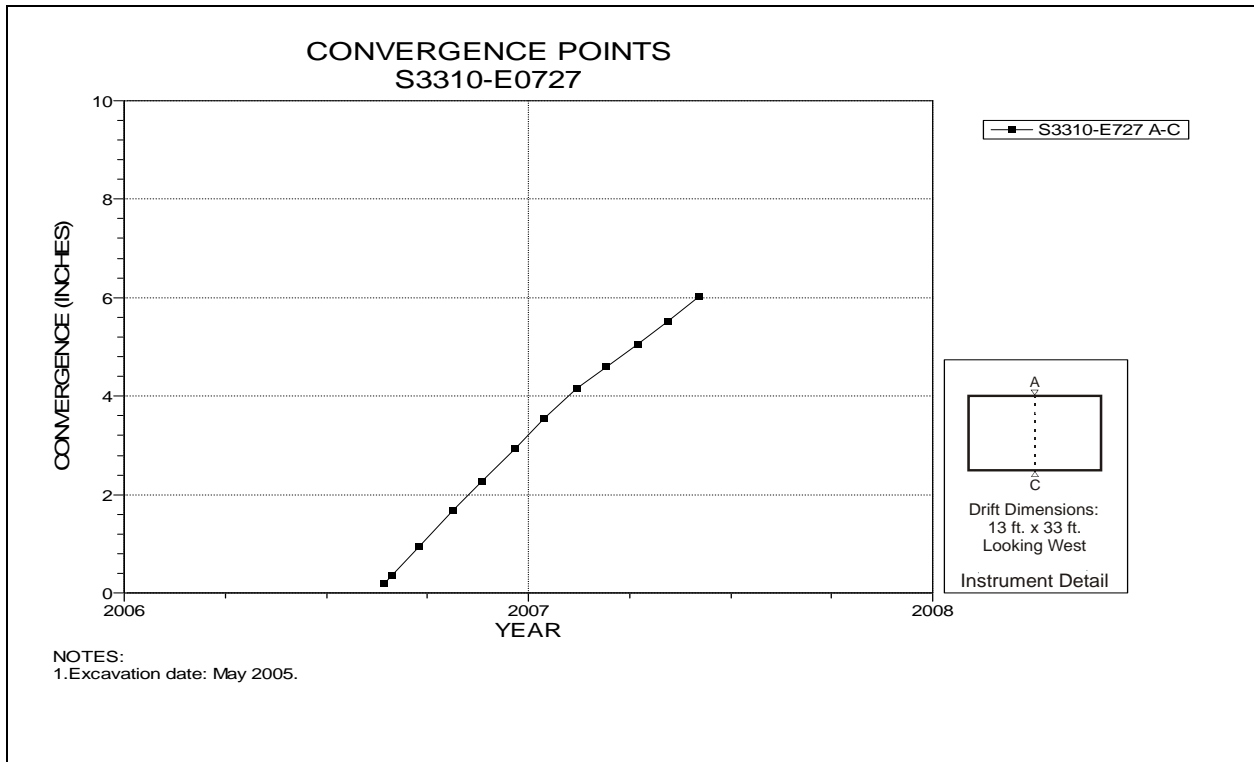


Figure 5-72 Convergence Point Array  
S3310 Drift at E727 – Roof to Floor

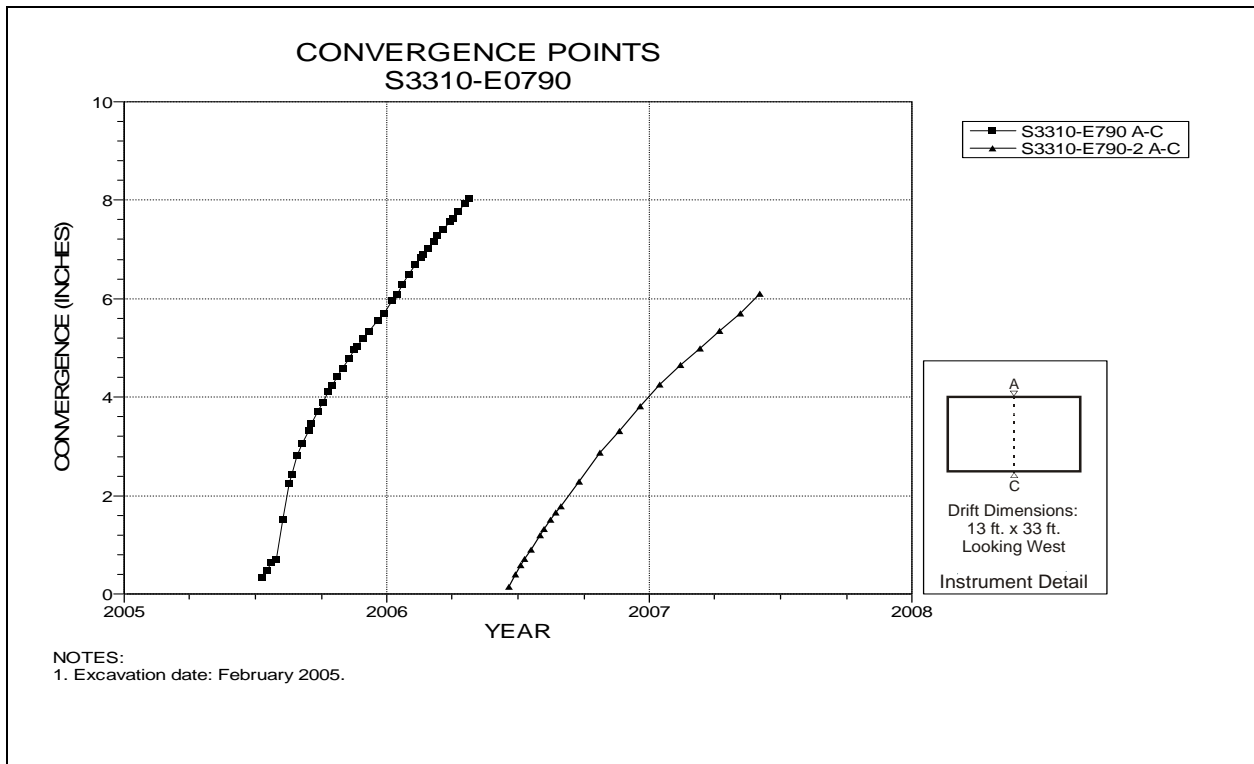


Figure 5-73 Convergence Point Array  
S3310 Drift at E790 Drift Intersection (Room 3, Panel 4) – Roof to Floor

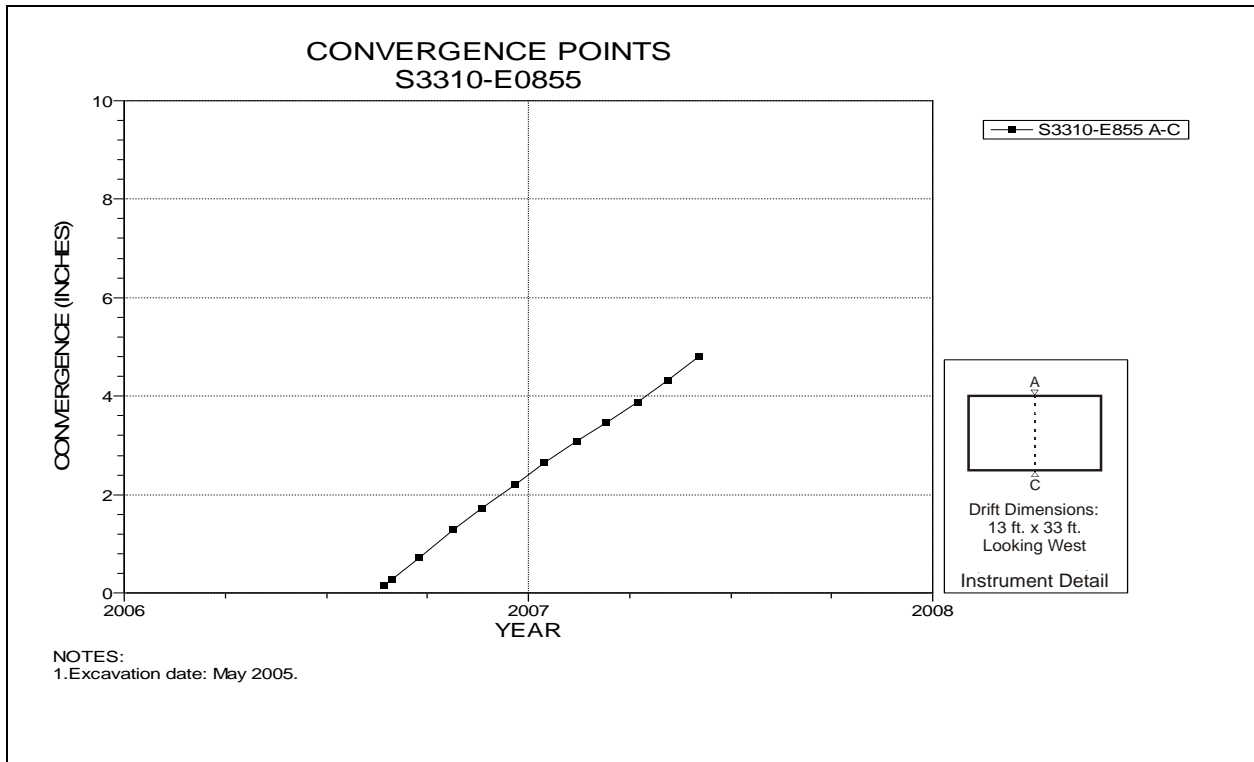


Figure 5-74 Convergence Point Array  
S3310 Drift at E855 – Roof to Floor

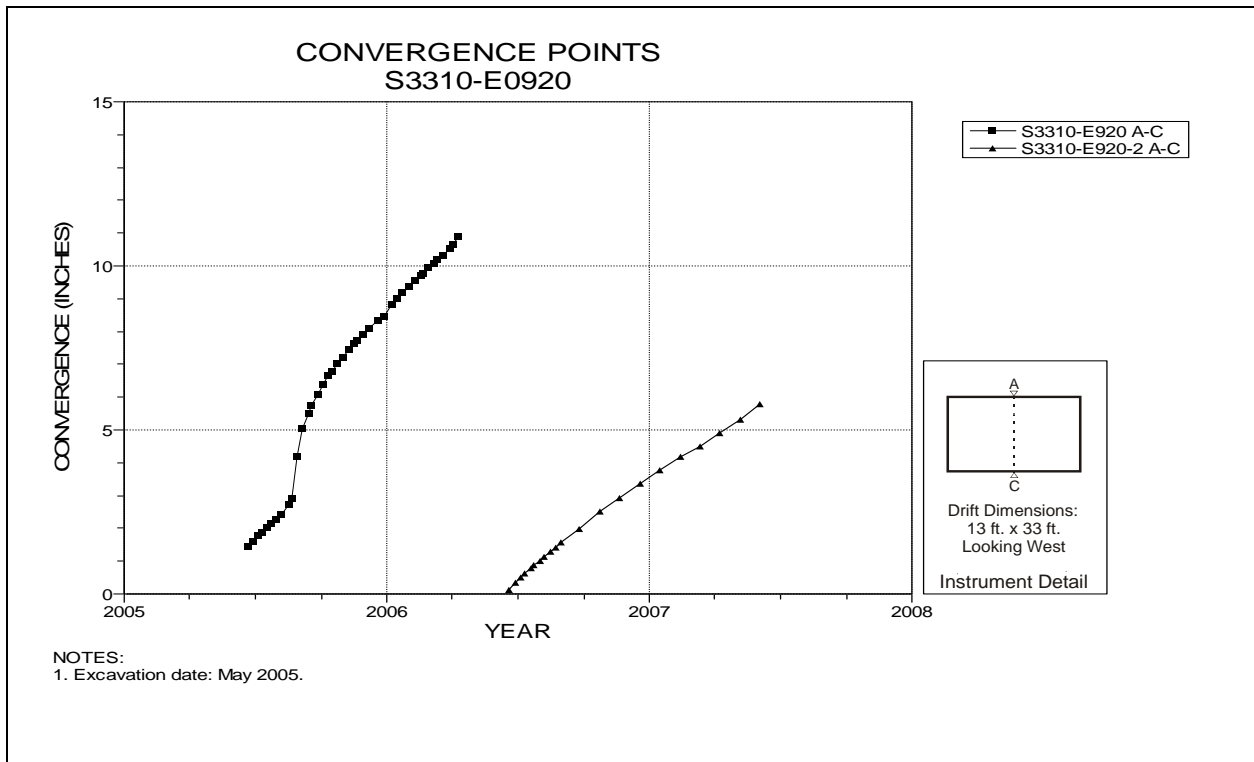


Figure 5-75 Convergence Point Array  
S3310 Drift at E920 Drift Intersection (Room 4, Panel 4) – Roof to Floor

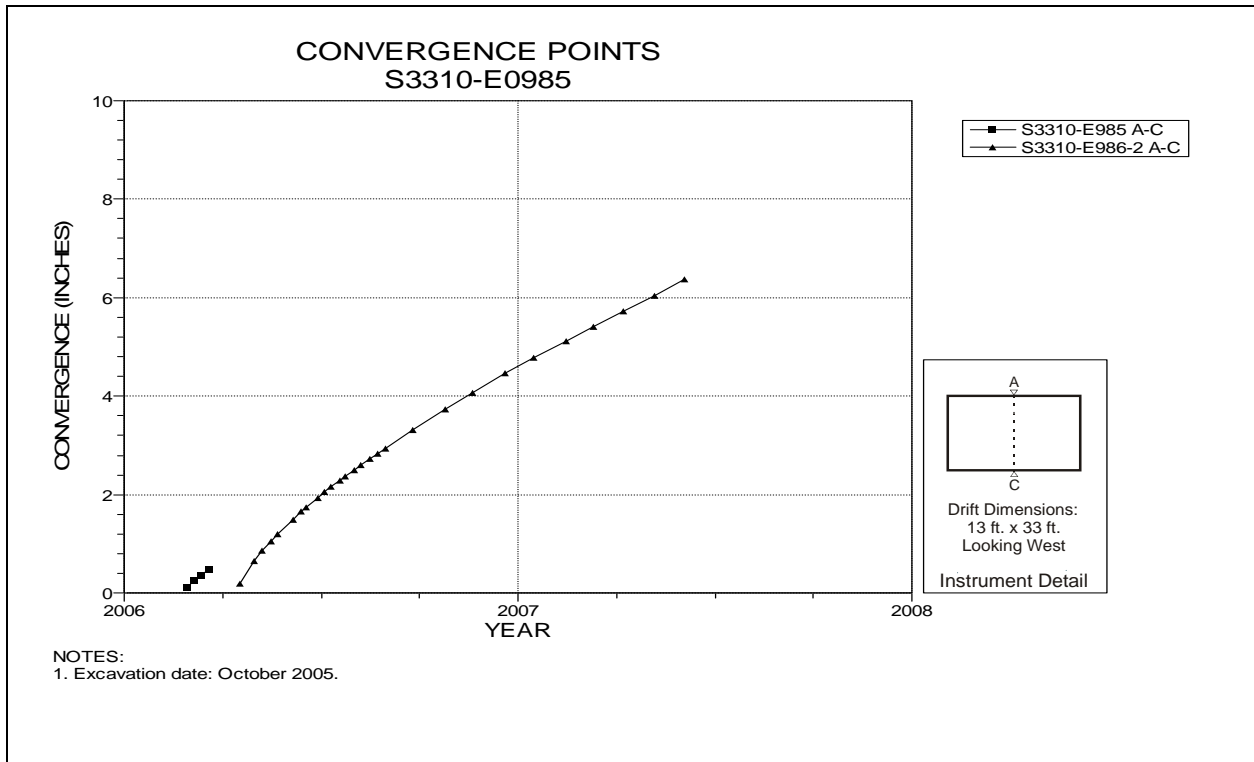


Figure 5-76 Convergence Point Array  
S3310 Drift at E986 – Roof to Floor

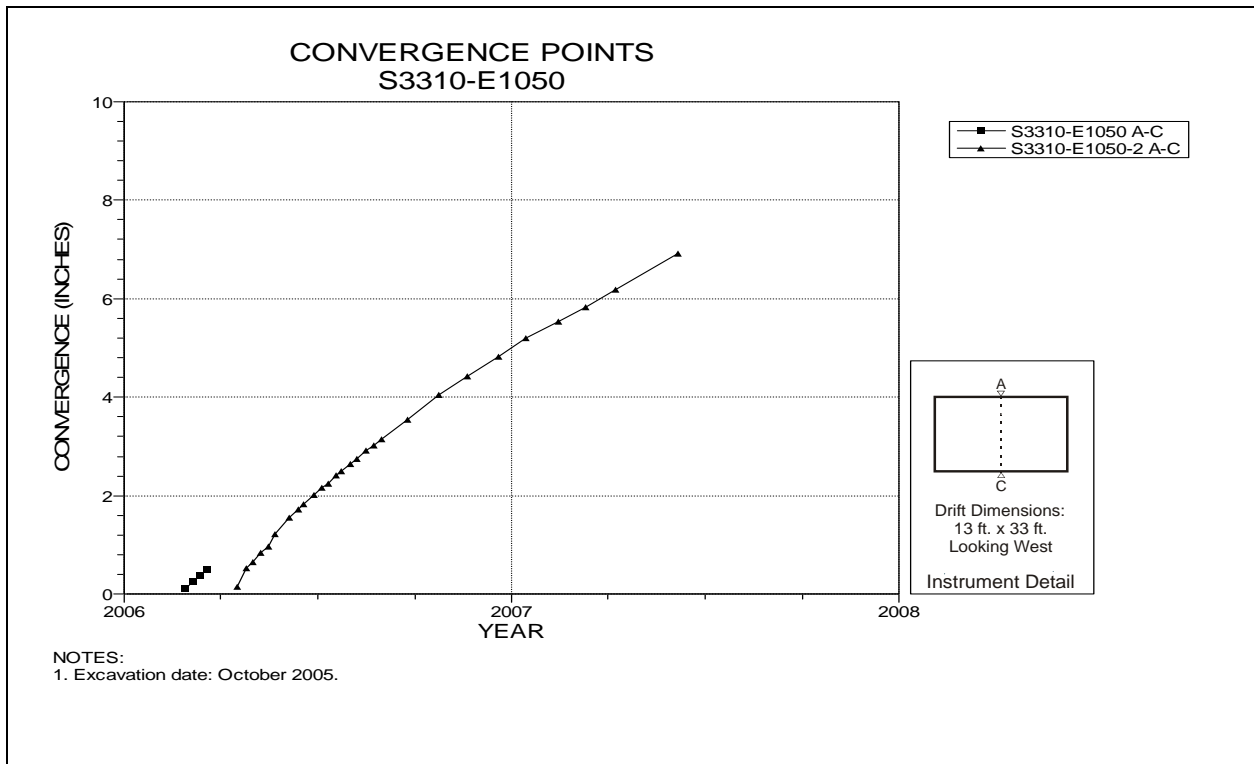


Figure 5-77 Convergence Point Array  
S3310 Drift at E1050 Drift Intersection (Room 5, Panel 4) – Roof to Floor

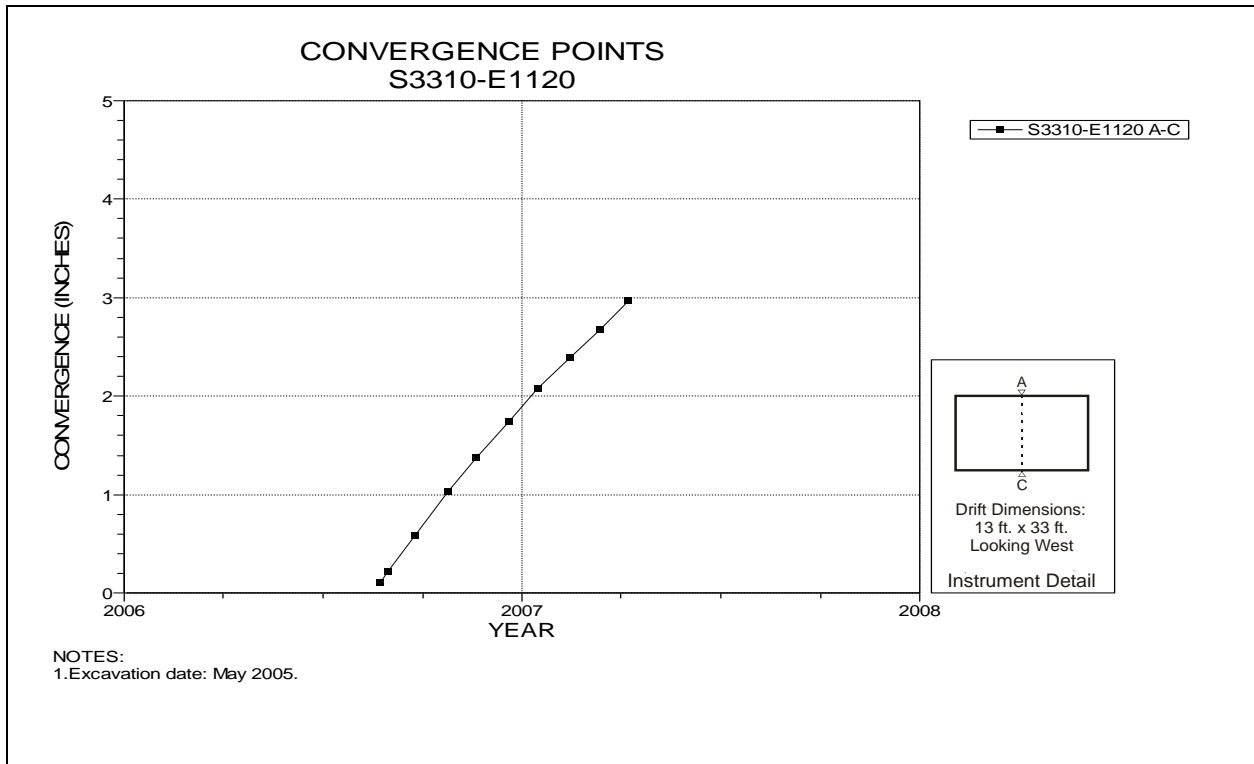


Figure 5-78 Convergence Point Array  
S3310 Drift at E1120 Drift – Roof to Floor

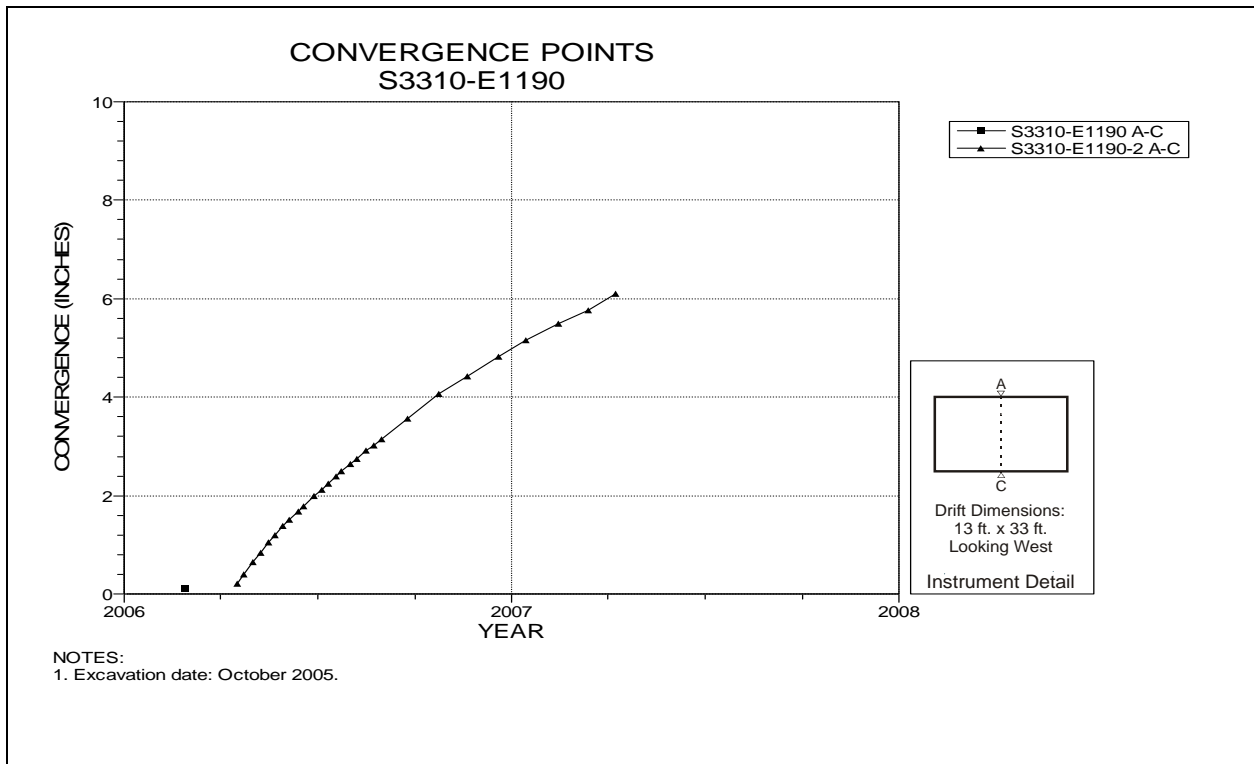


Figure 5-79 Convergence Point Array  
S3310 Drift at E1190 Drift Intersection (Room 6, Panel 4) – Roof to Floor



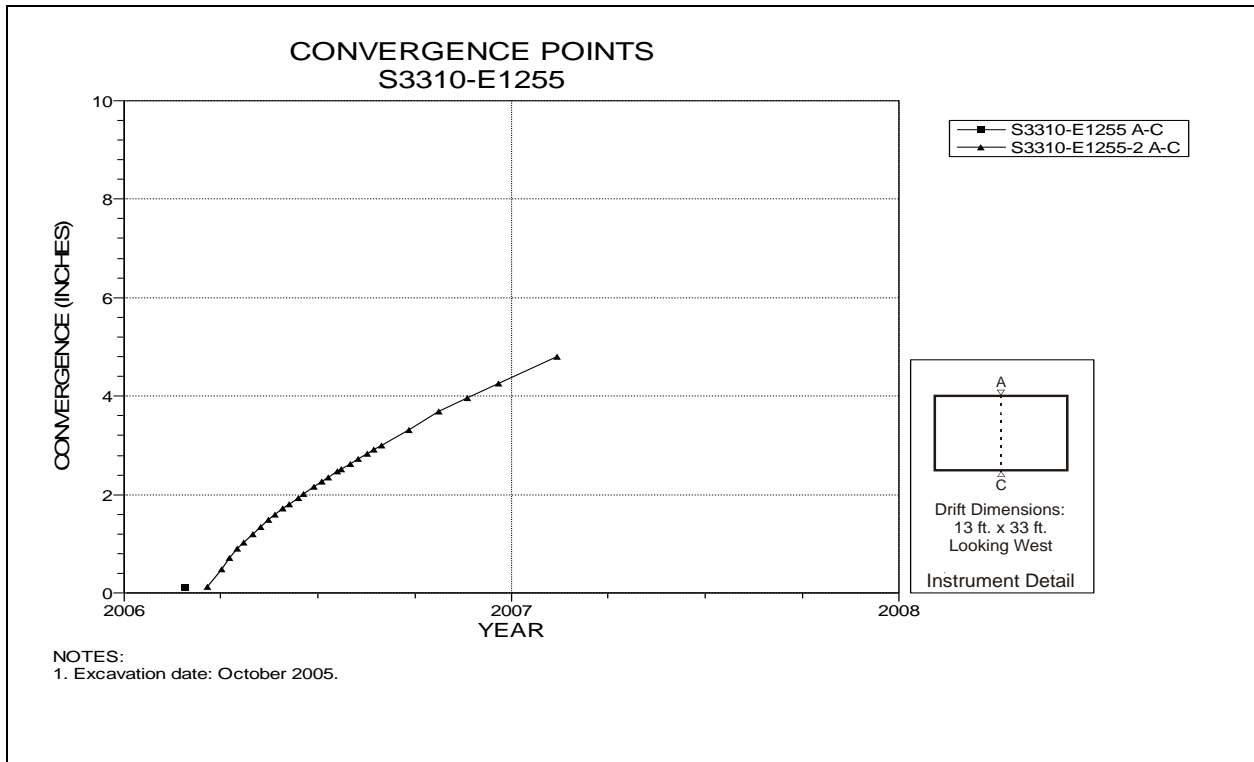


Figure 5-80 Convergence Point Array  
S3310 Drift at E1255 – Roof to Floor

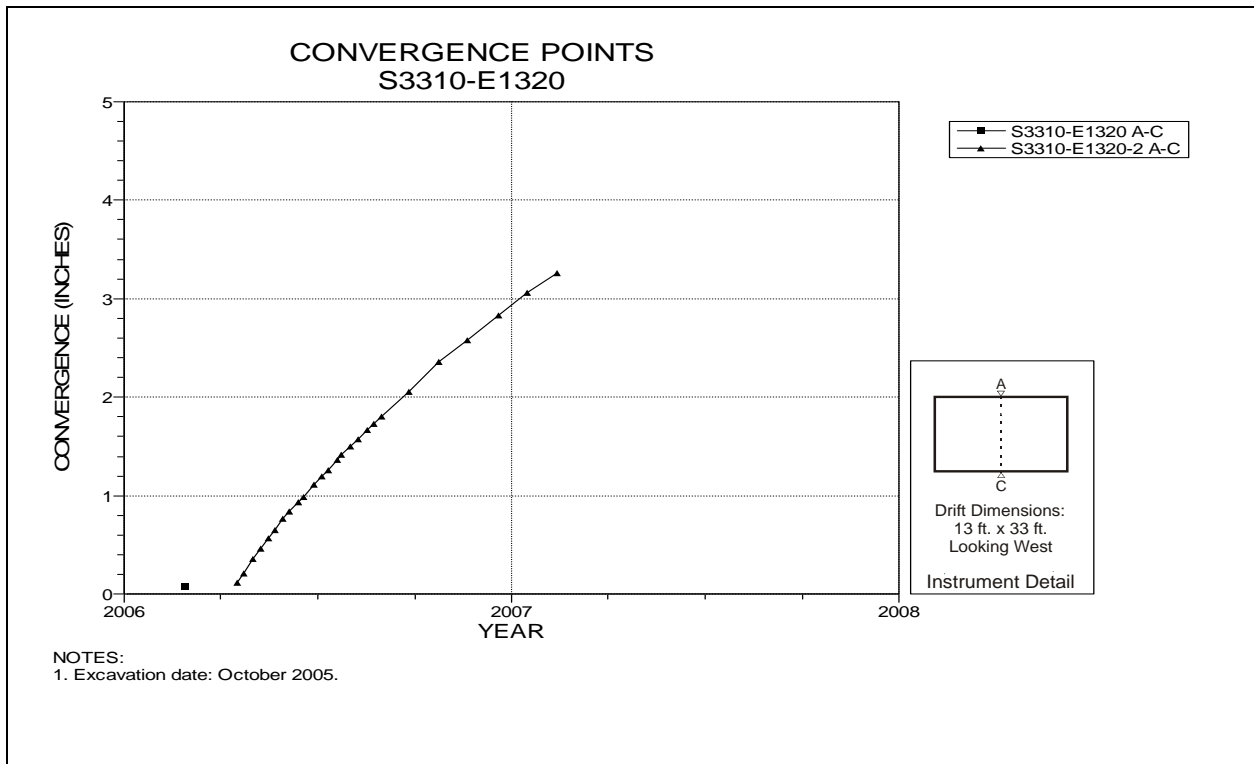


Figure 5-81 Convergence Point Array  
S3310 Drift at E1320 Drift Intersection (Room 7, Panel 4) – Roof to Floor

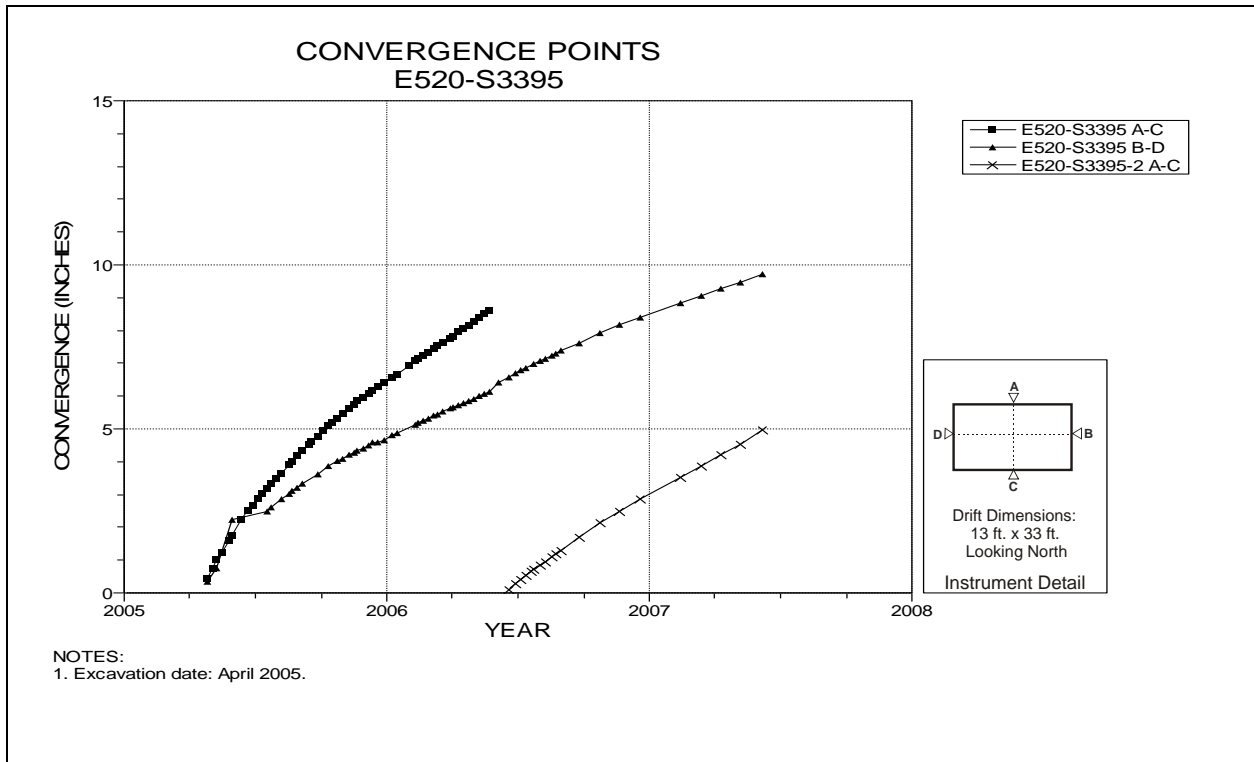


Figure 5-82 Convergence Point Array  
Room 1, Panel 4 at S3395 – All Chords

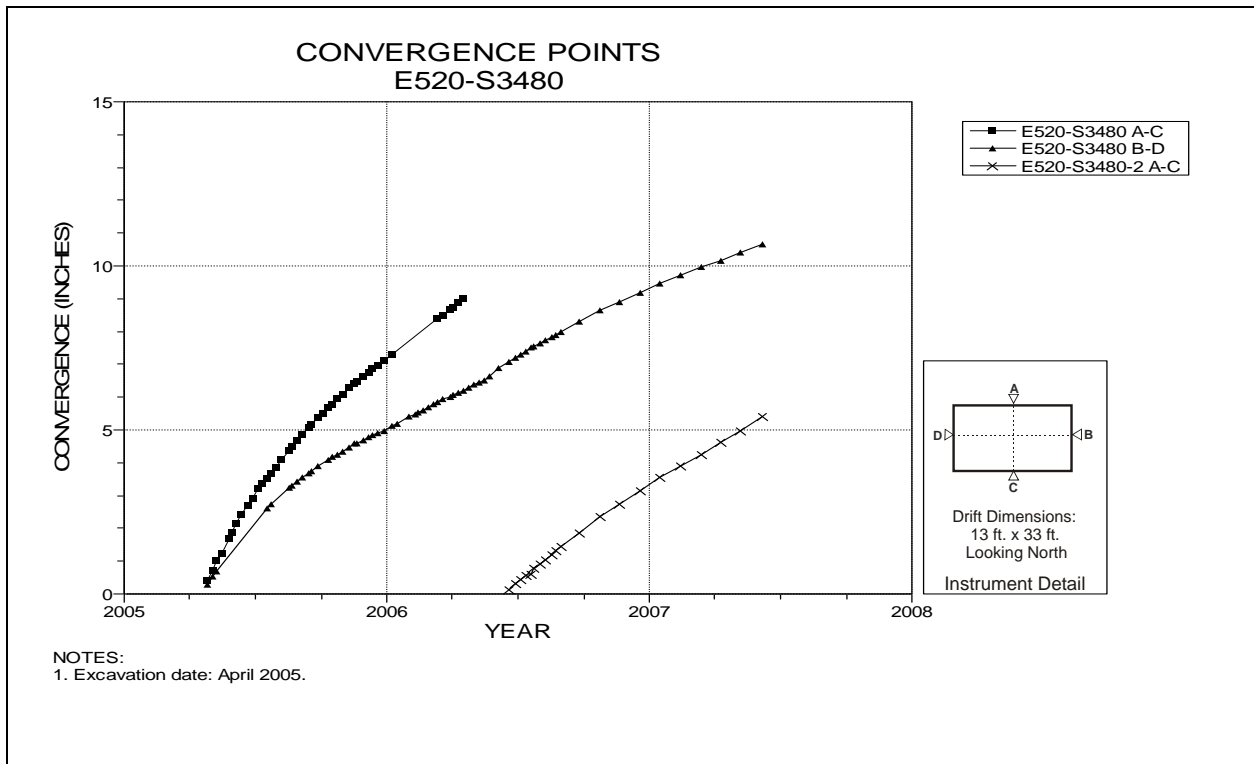


Figure 5-83 Convergence Point Array  
Room 1, Panel 4 at S3480 – Room Center – All Chords

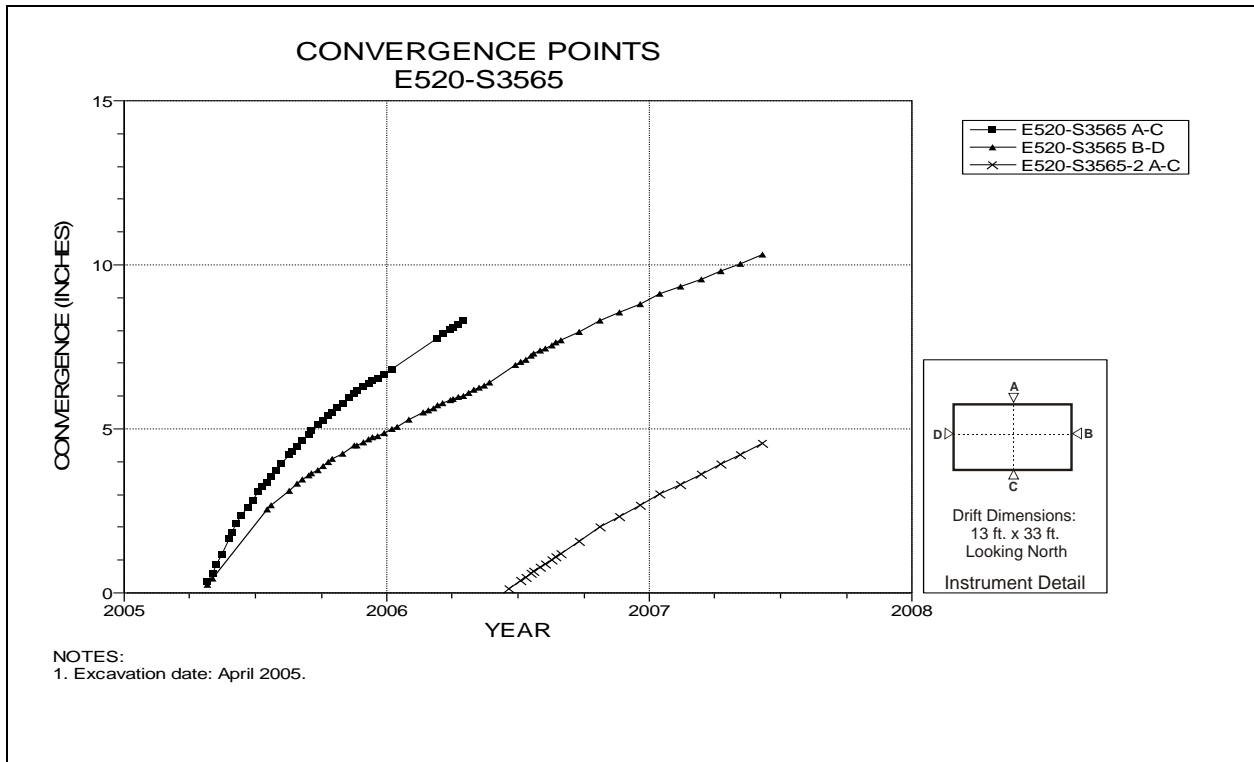


Figure 5-84 Convergence Point Array  
Room 1, Panel 4 at S3565 – All Chords

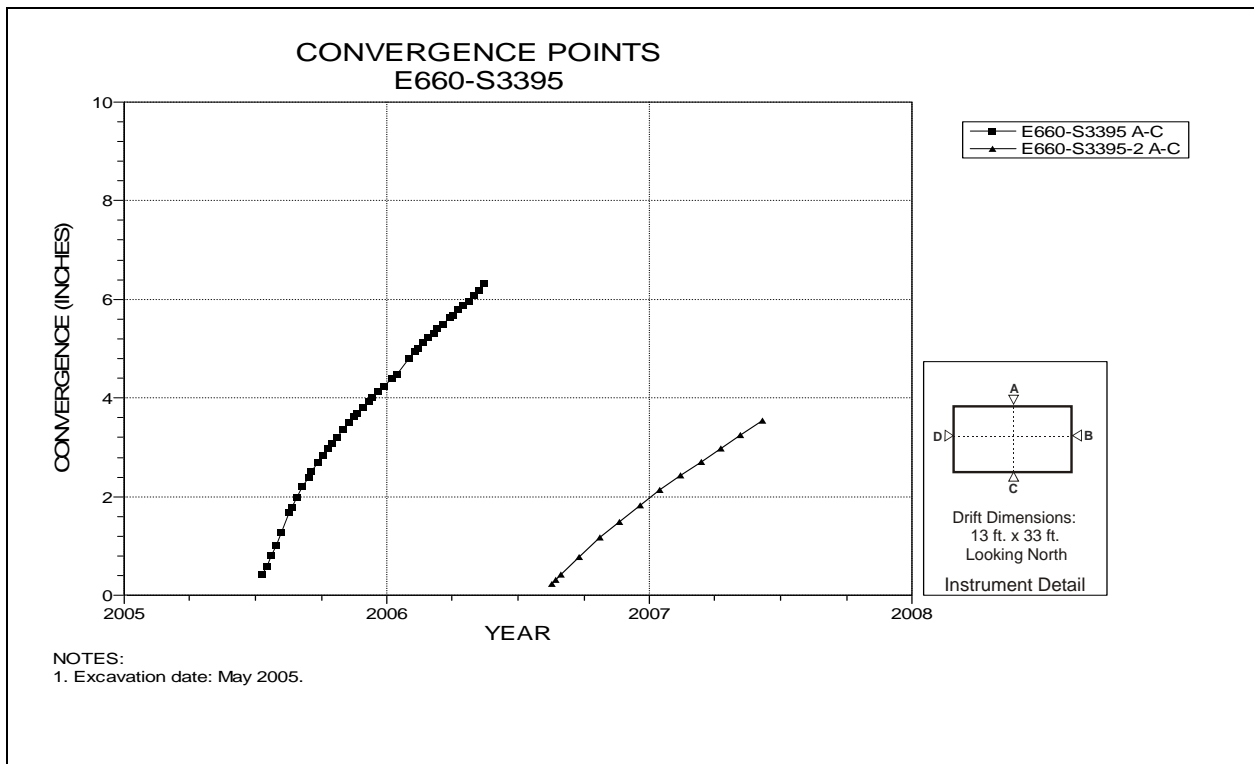


Figure 5-85 Convergence Point Array  
Room 2, Panel 4 at S3395 – All Chords

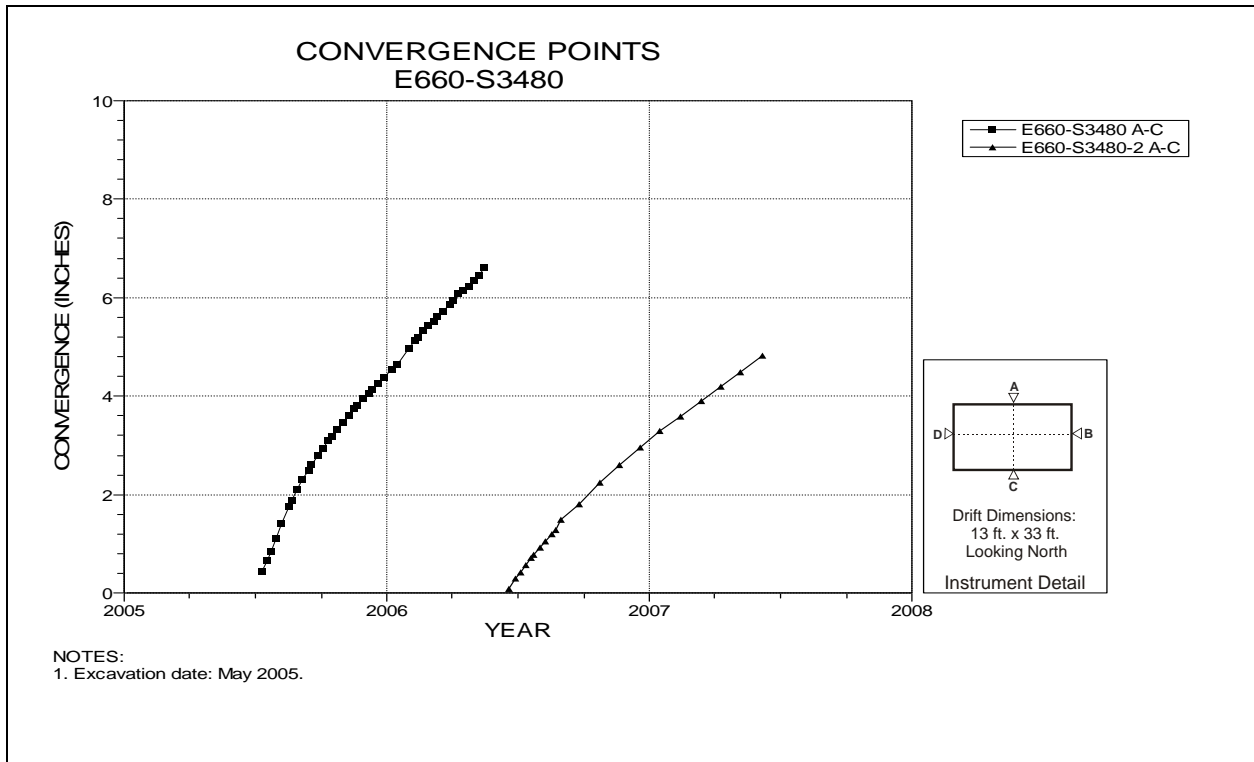


Figure 5-86 Convergence Point Array  
 Room 2, Panel 4 at S3480 – Room Center – All Chords

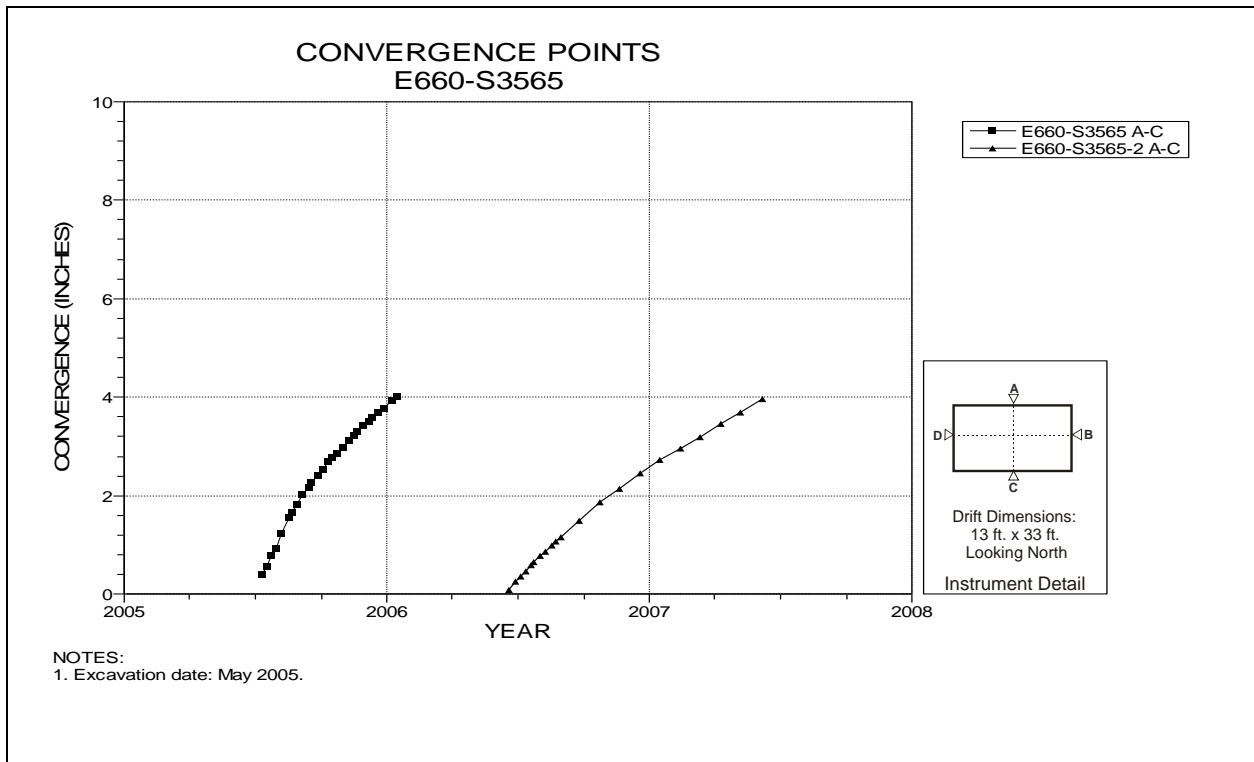


Figure 5-87 Convergence Point Array  
 Room 2, Panel 4 at S3565 – All Chords

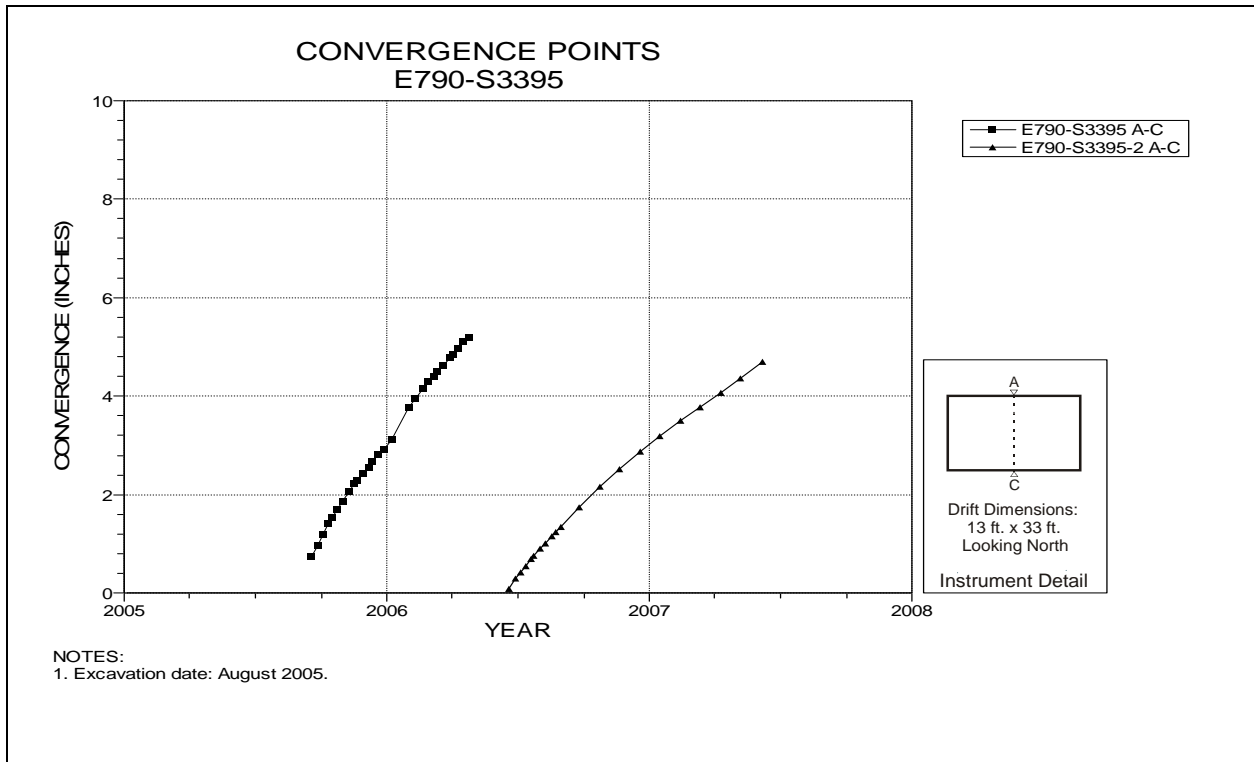


Figure 5-88 Convergence Point Array  
Room 3, Panel 4 at S3395 – All Chords

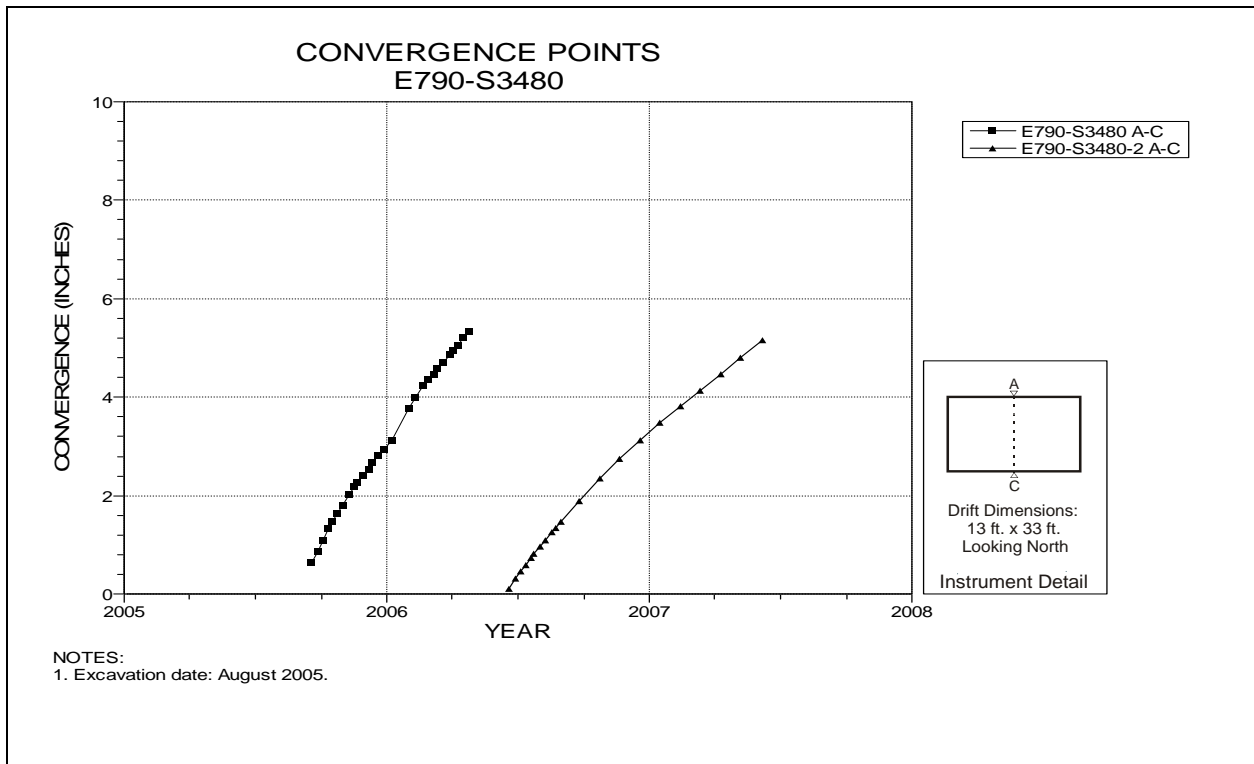


Figure 5-89 Convergence Point Array  
Room 3, Panel 4 at S3480 – Room Center – All Chords

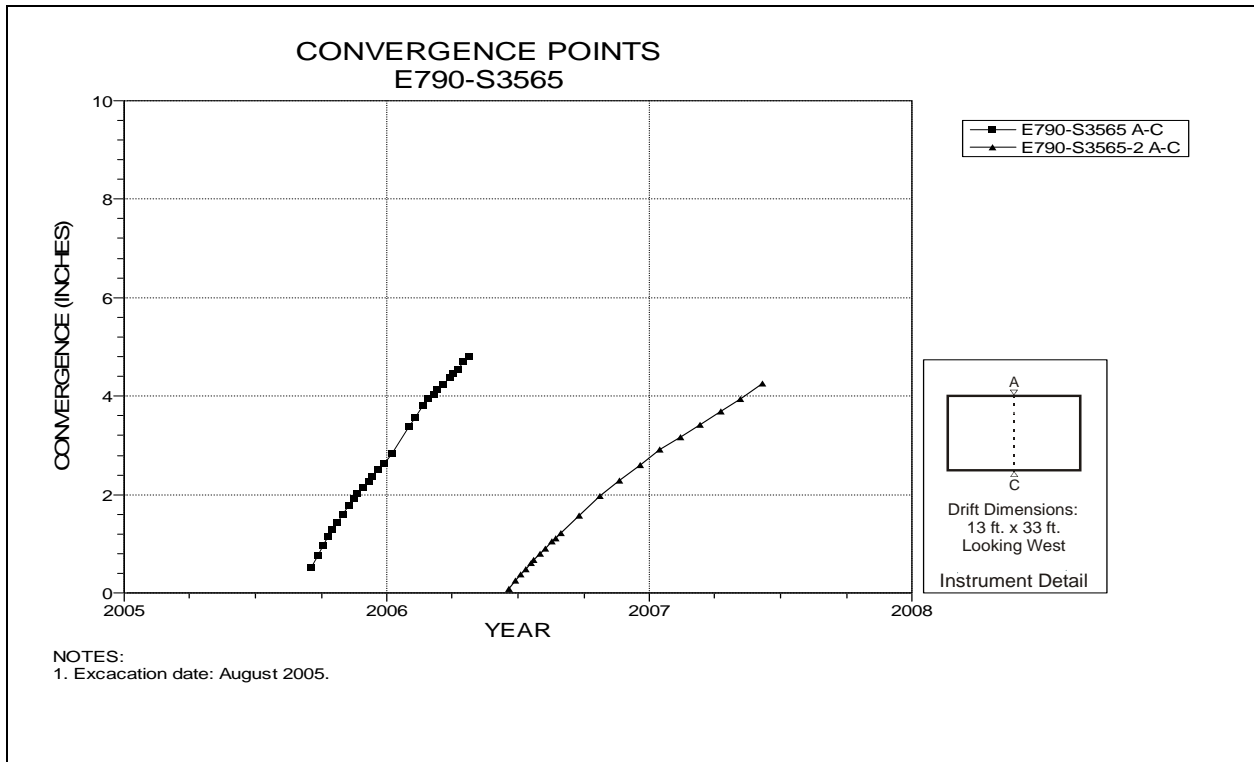


Figure 5-90 Convergence Point Array  
Room 3, Panel 4 at S3565 – All Chords

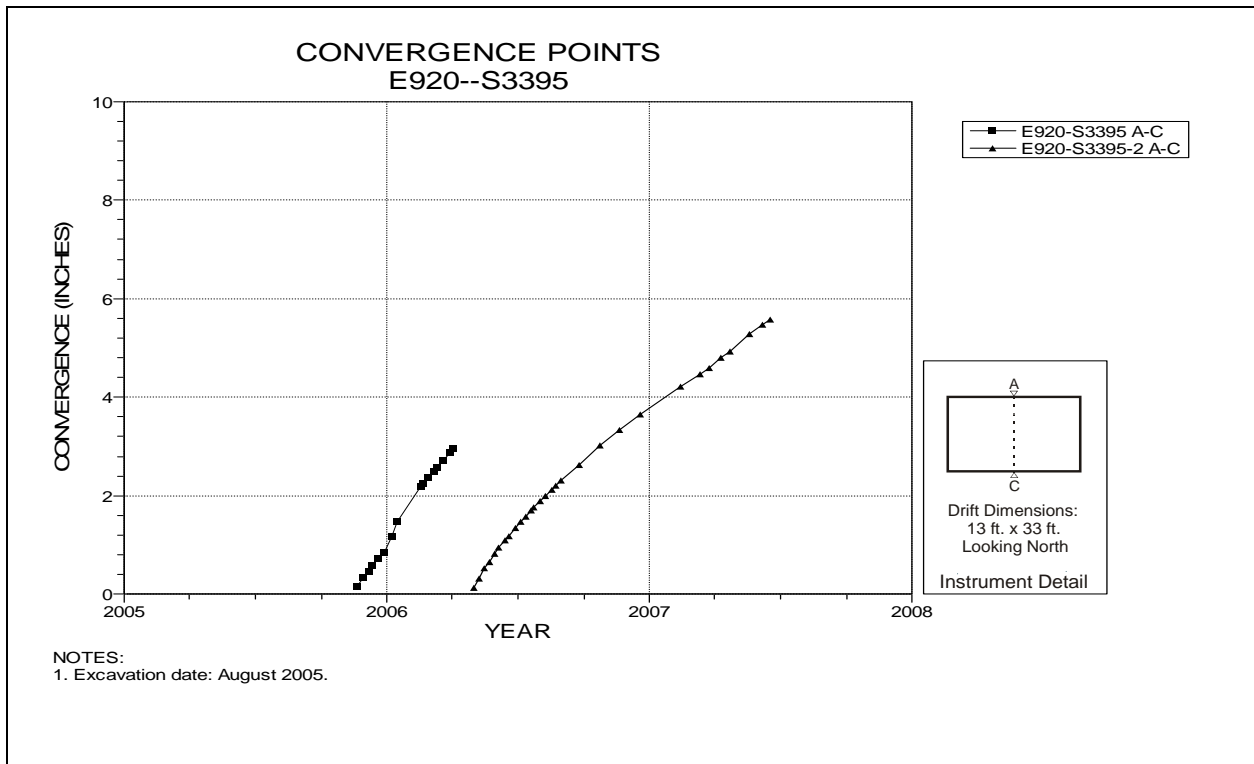


Figure 5-91 Convergence Point Array  
Room 4, Panel 4 at S3395 – All Chords

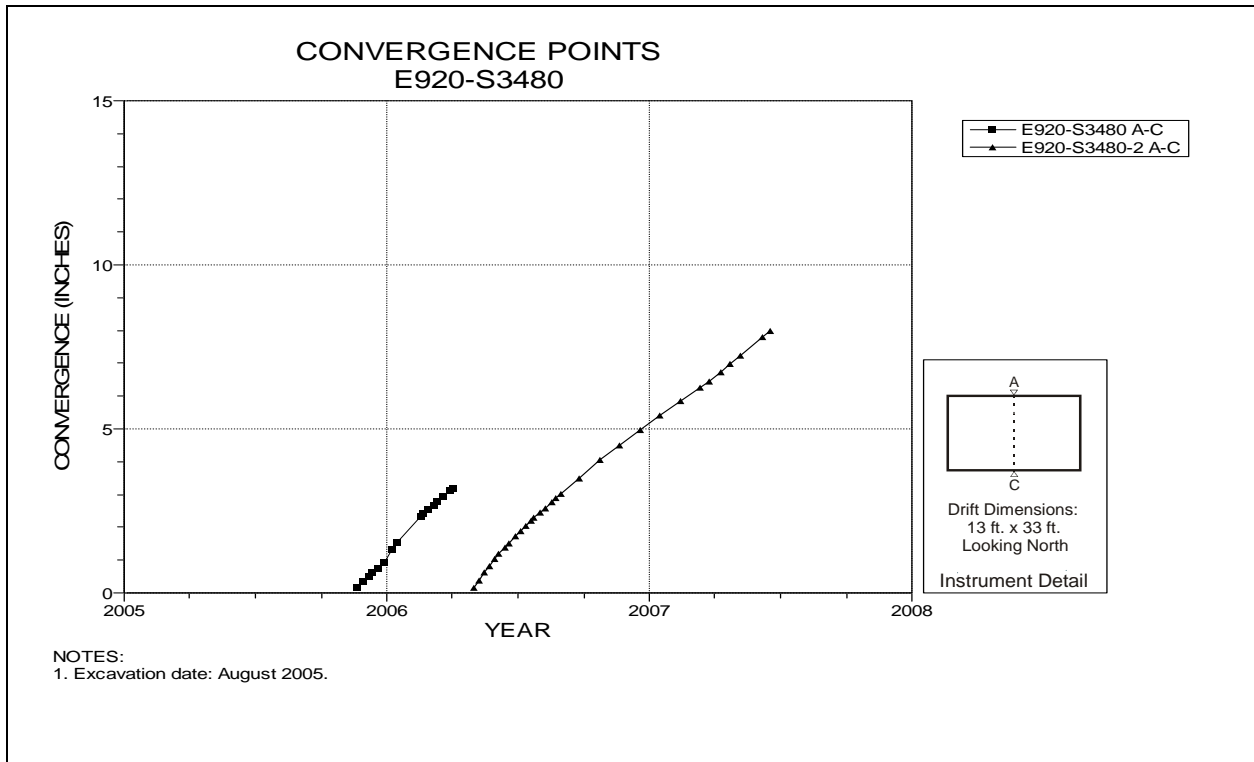


Figure 5-92 Convergence Point Array  
 Room 4, Panel 4 at S3480 – Room Center – All Chords

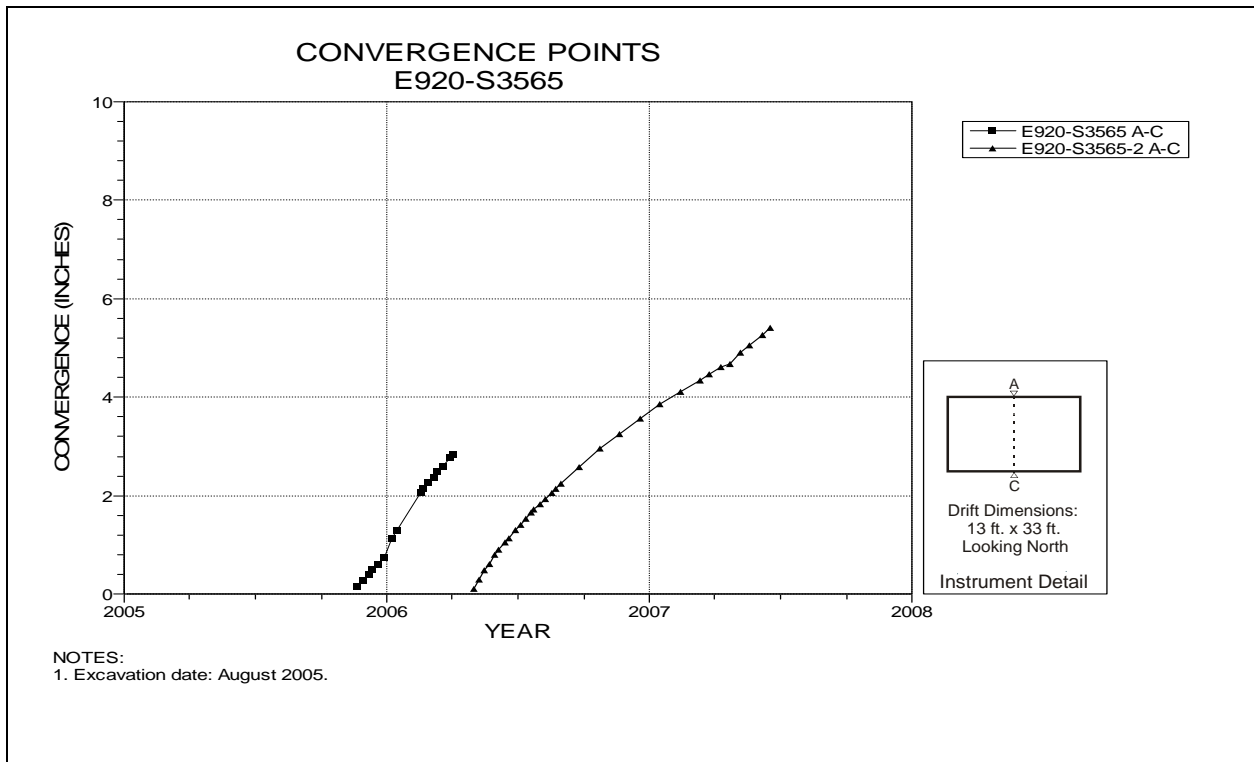


Figure 5-93 Convergence Point Array  
 Room 4, Panel 4 at S3565 – All Chords

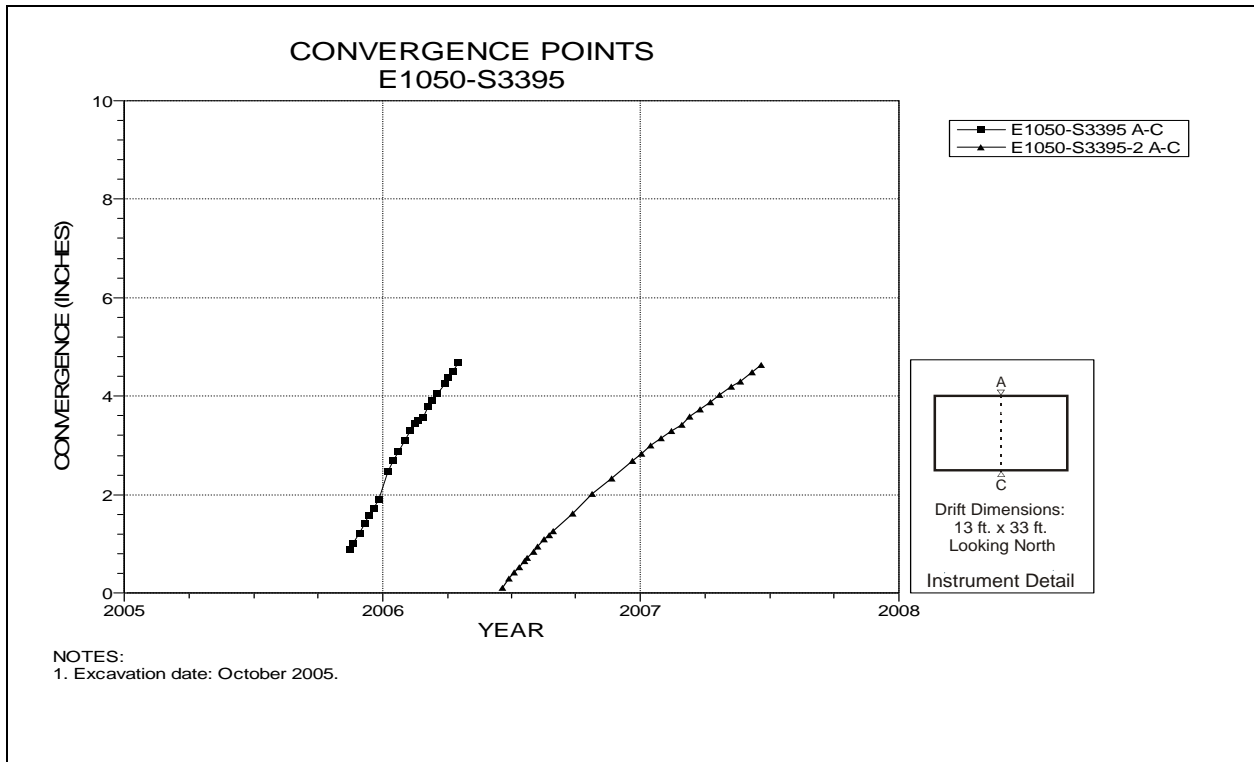


Figure 5-94 Convergence Point Array  
Room 5, Panel 4 at S3395 – All Chords

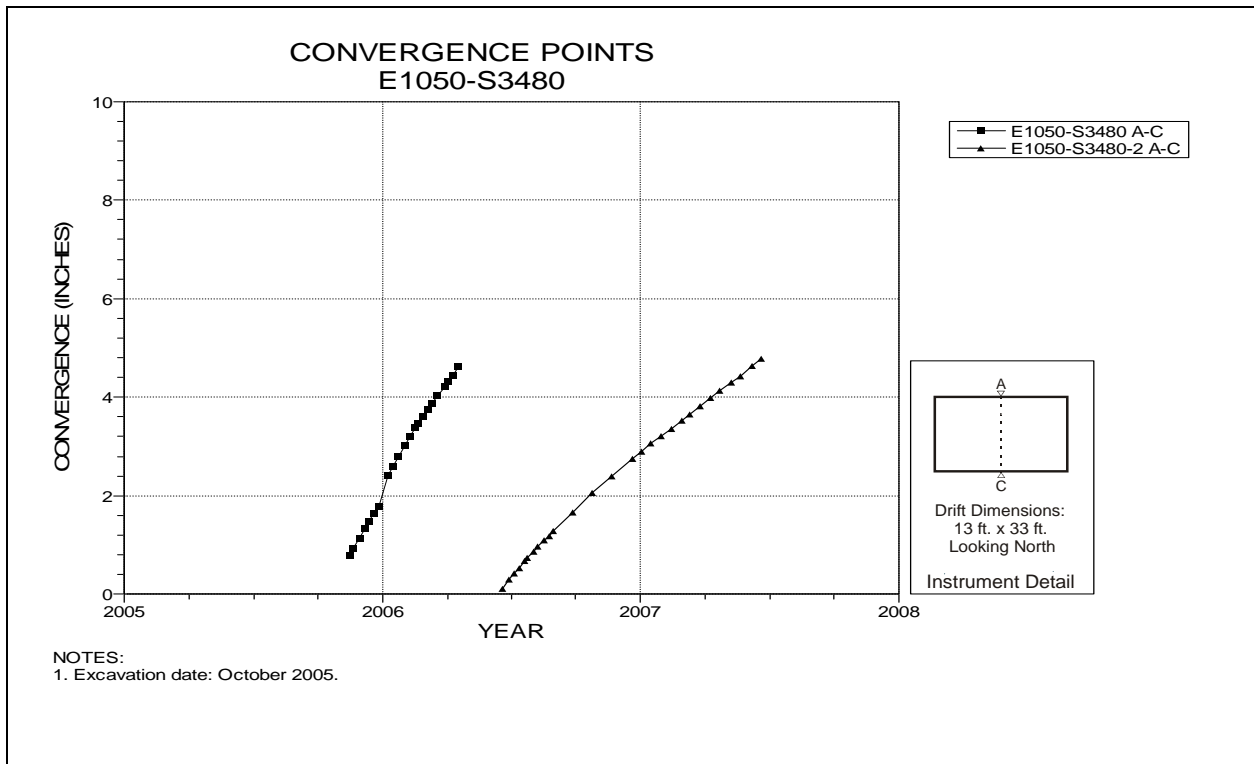


Figure 5-95 Convergence Point Array  
Room 5, Panel 4 at S3480 – Room Center – All Chords



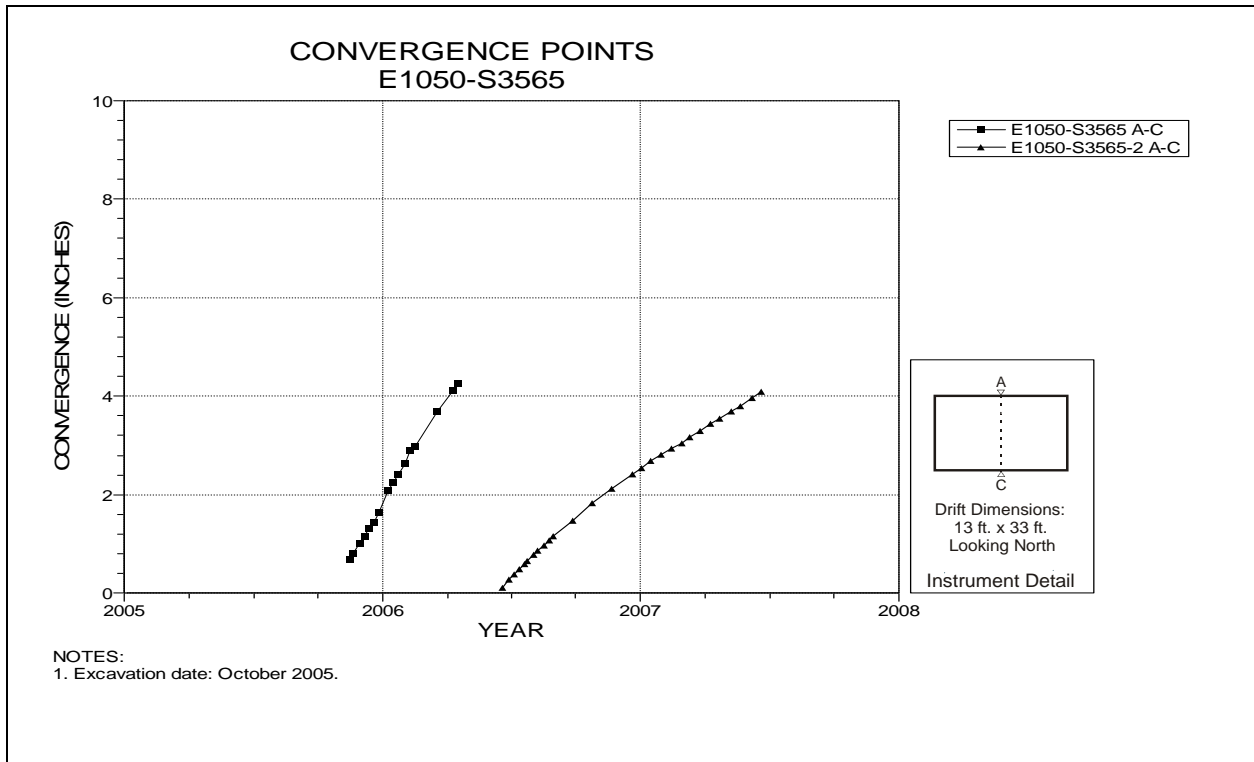


Figure 5-96 Convergence Point Array  
 Room 5, Panel 4 at S3565 – All Chords

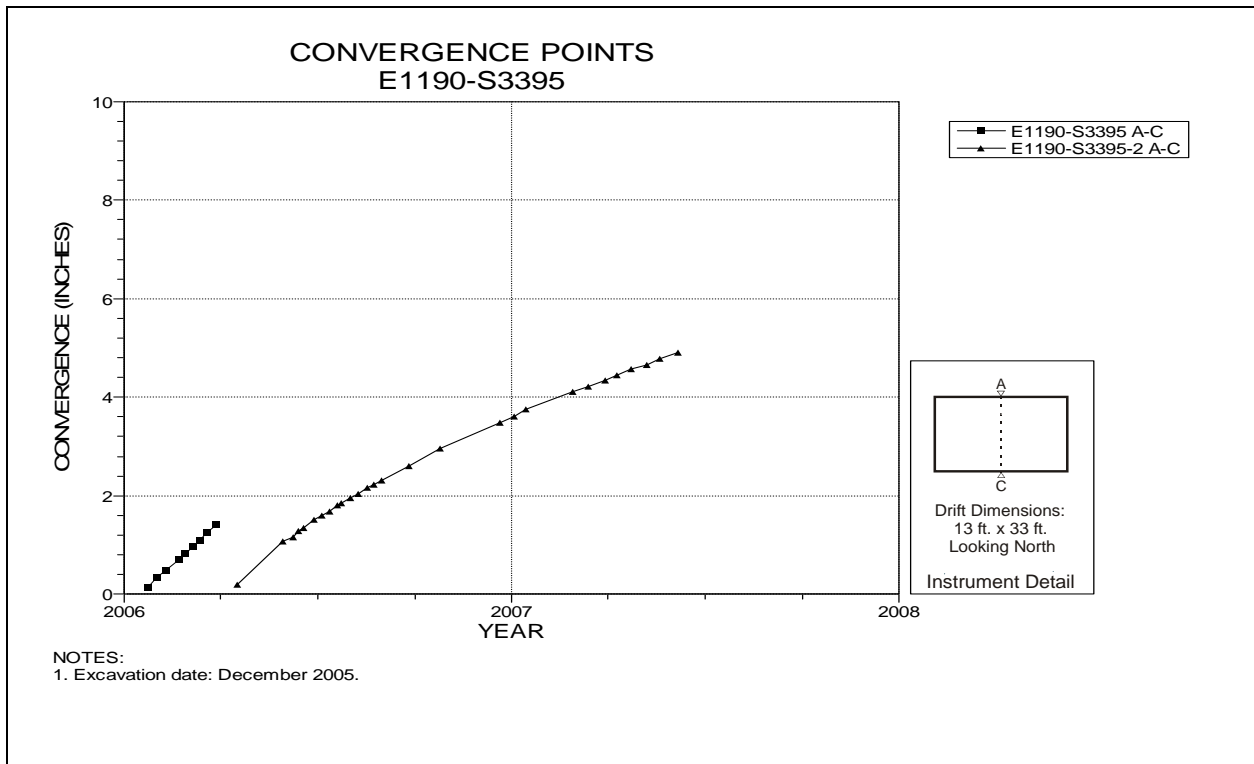


Figure 5-97 Convergence Point Array  
 Room 6, Panel 4 at S3395 – All Chords

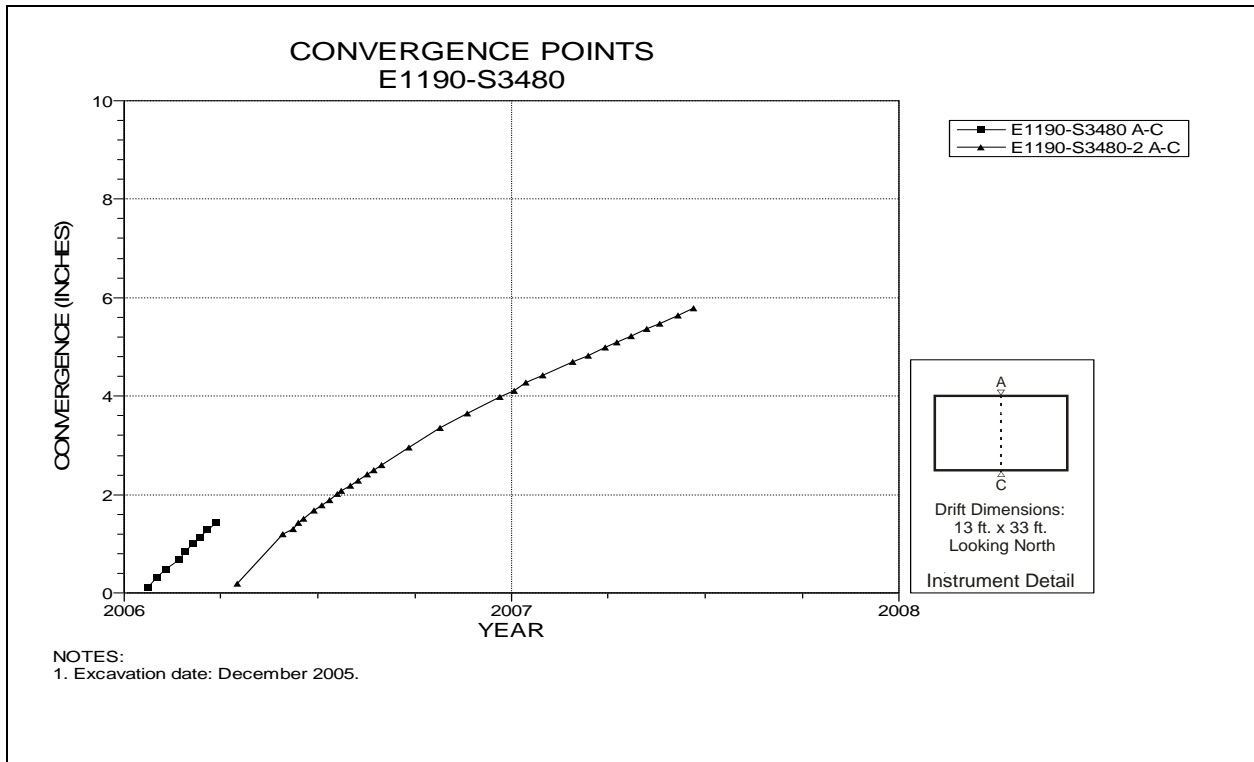


Figure 5-98 Convergence Point Array  
Room 6, Panel 4 at S3480 – Room Center – All Chords

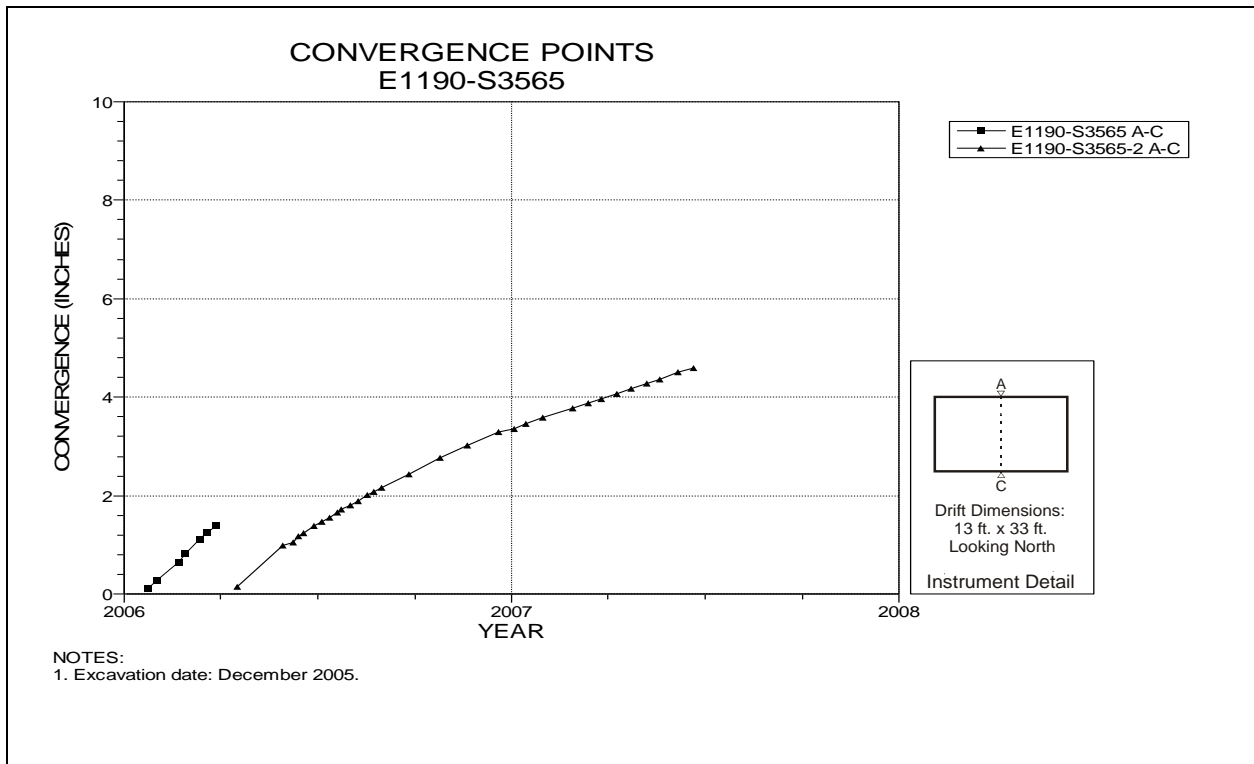


Figure 5-99 Convergence Point Array  
Room 6, Panel 4 at S3565 – All Chords

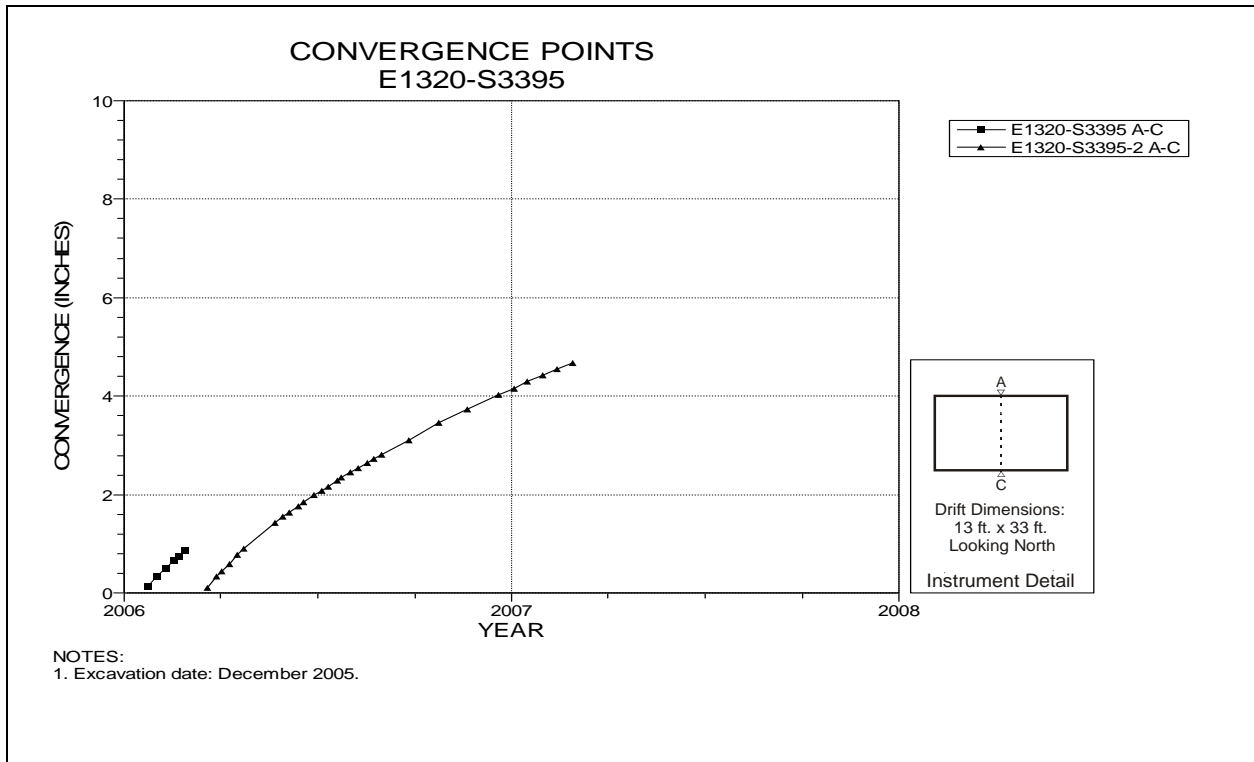


Figure 5-100 Convergence Point Array  
Room 7, Panel 4 at S3395 – All Chords

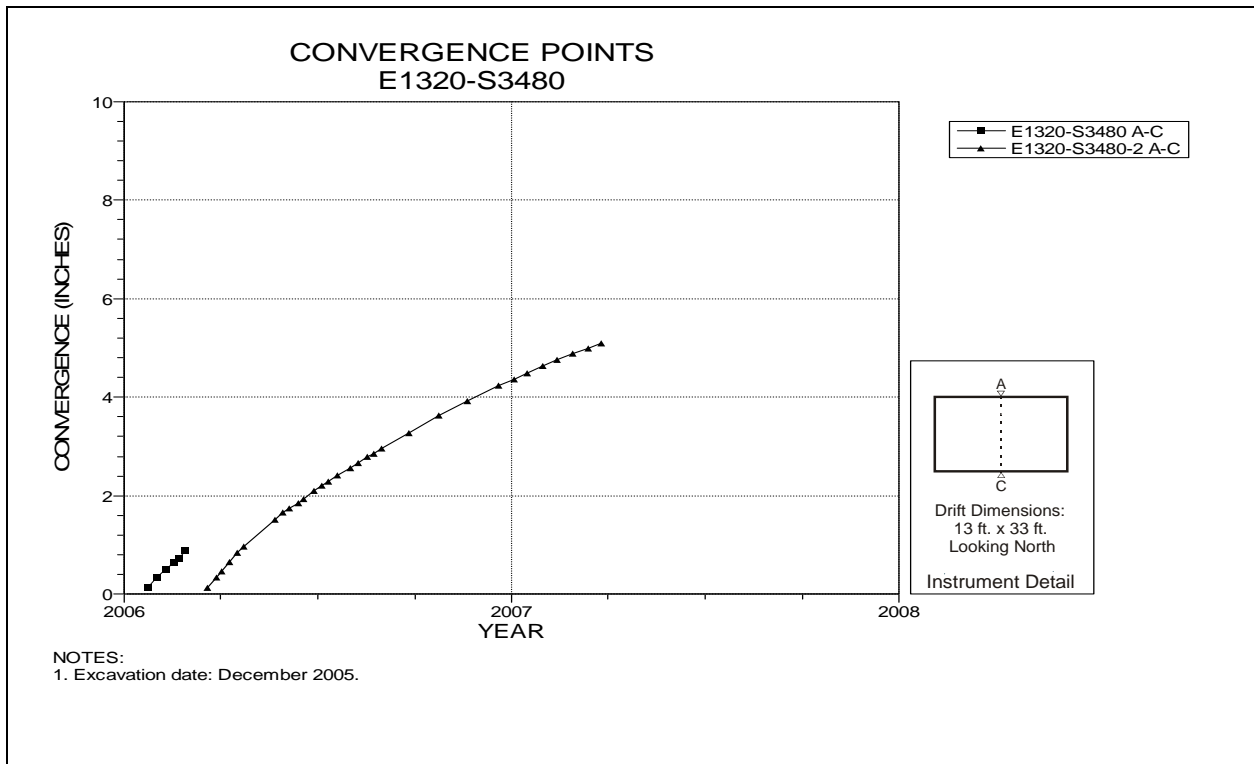


Figure 5-101 Convergence Point Array  
Room 7, Panel 4 at S3480 – Room Center – All Chords

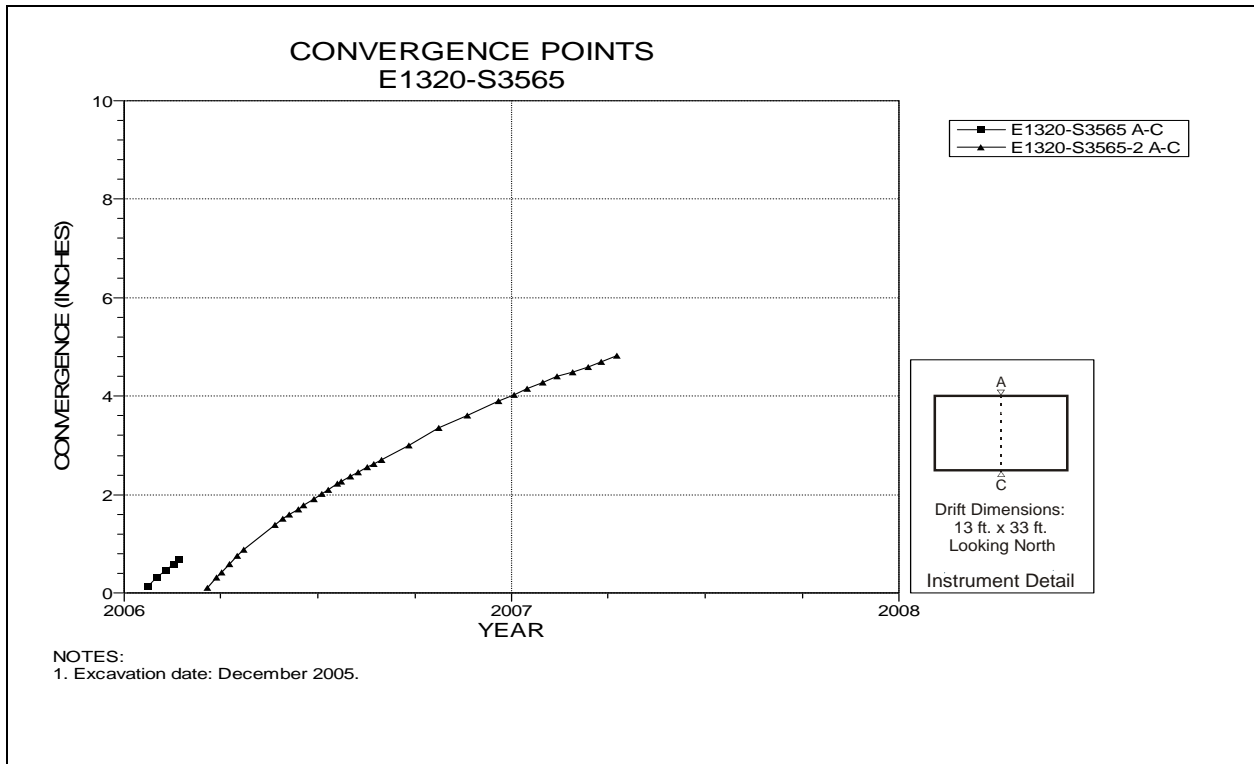


Figure 5-102 Convergence Point Array  
Room 7, Panel 4 at S3565 – All Chords

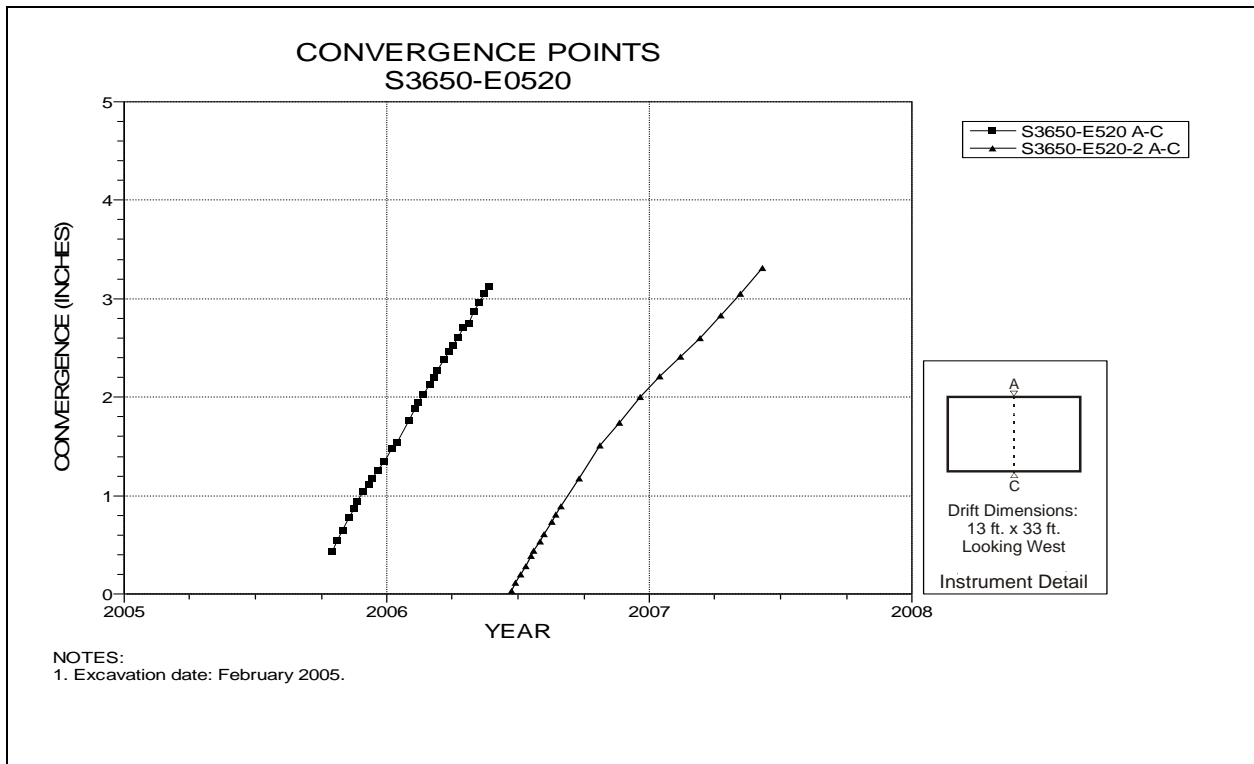


Figure 5-103 Convergence Point Array  
S3650 Drift at E520 Drift Intersection (Room 1, Panel 4) – Roof to Floor

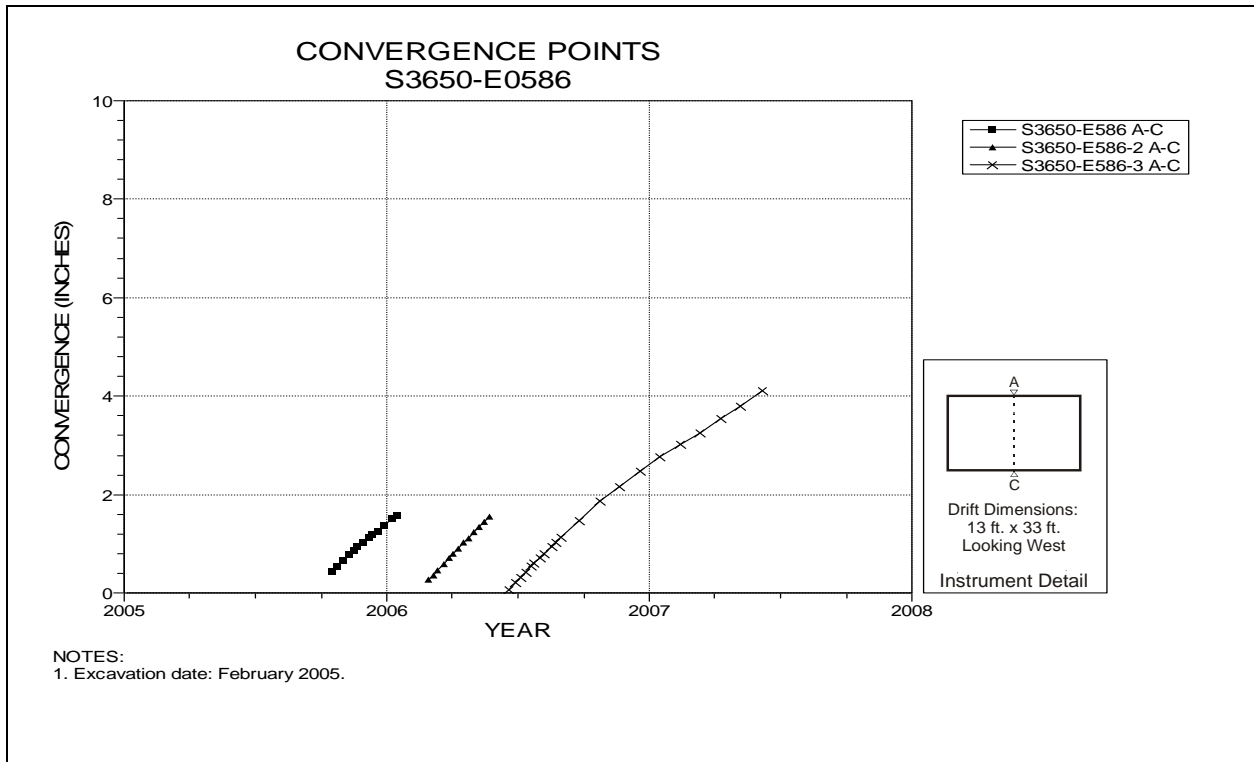


Figure 5-104 Convergence Point Array  
S3650 Drift at E586 – Roof to Floor

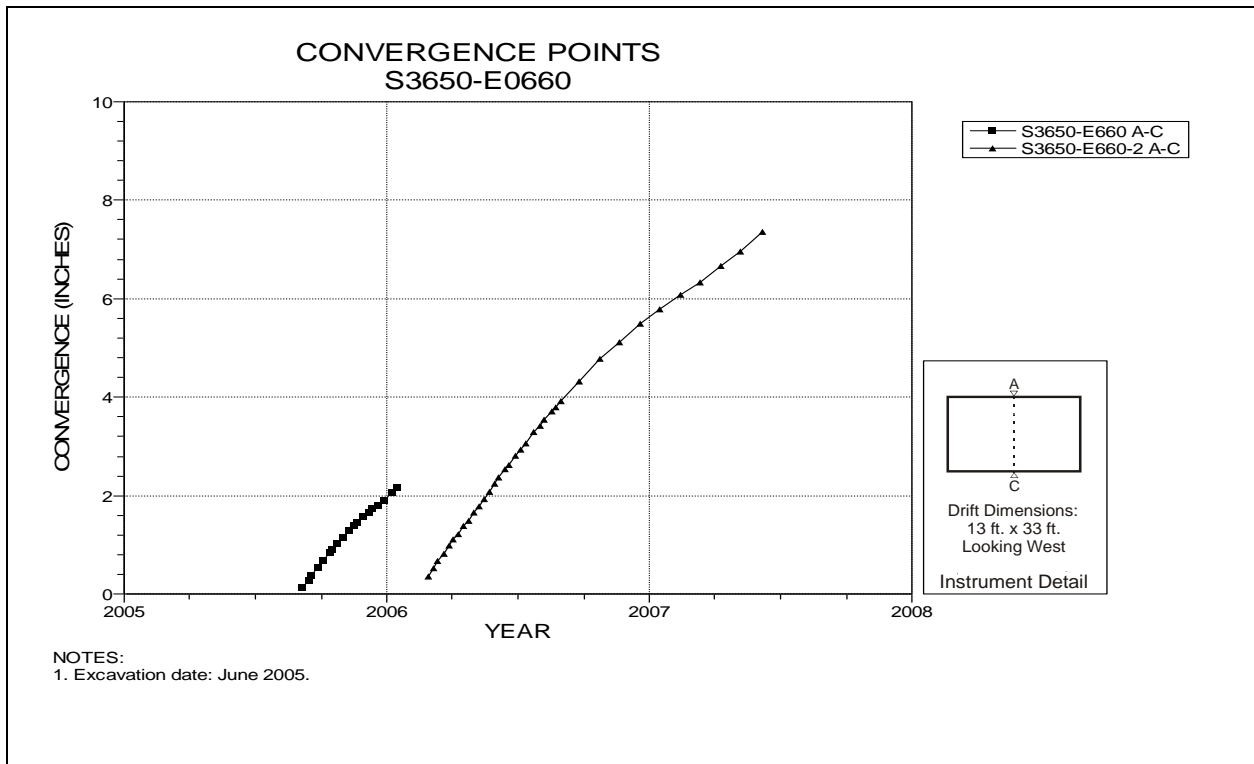


Figure 5-105 Convergence Point Array  
S3650 Drift at E660 Drift Intersection (Room 2, Panel 4) – Roof to Floor

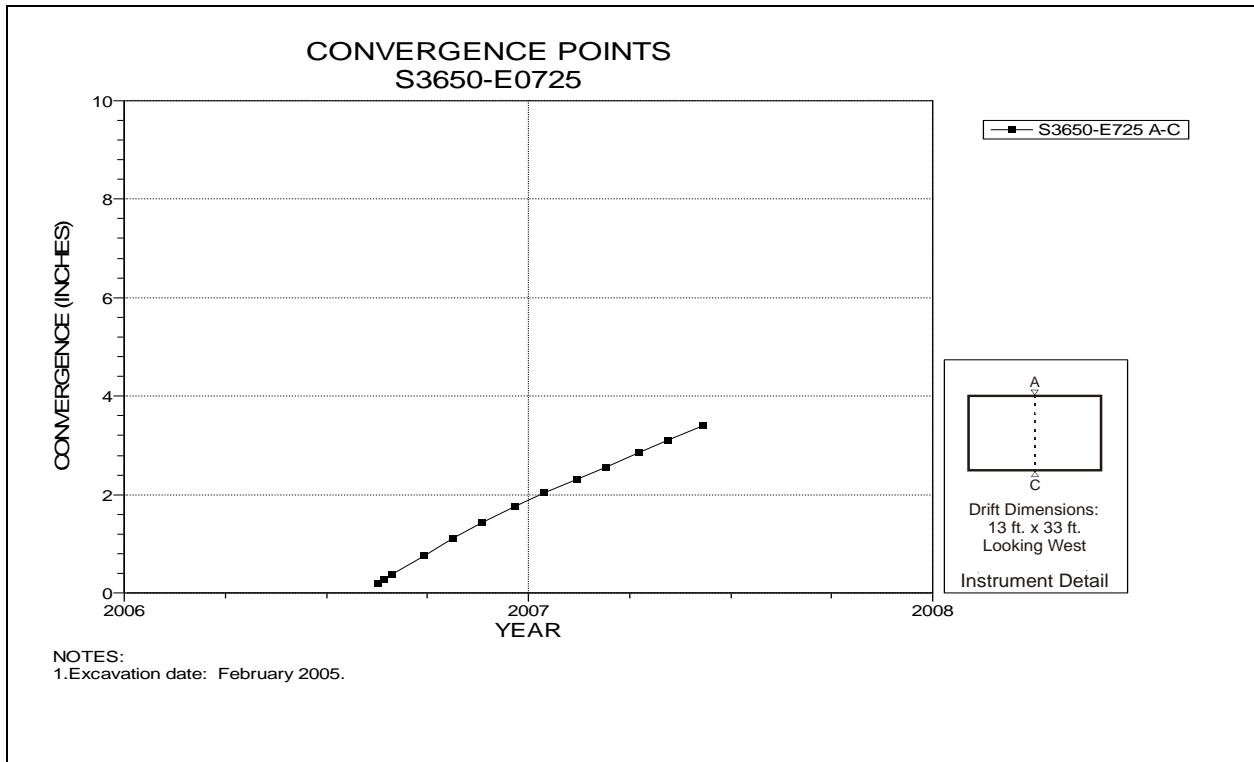


Figure 5-106 Convergence Point Array  
S3650 Drift at E725 – Roof to Floor

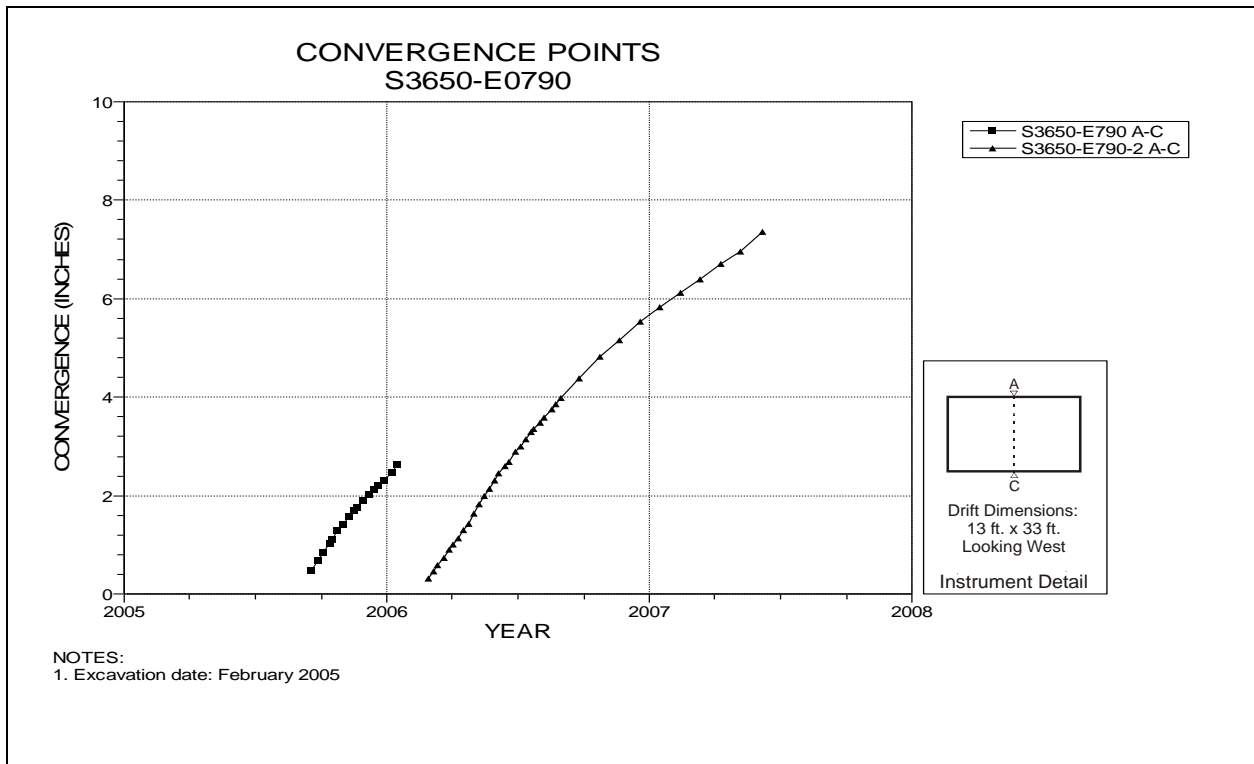


Figure 5-107 Convergence Point Array  
S3650 Drift at E790 Drift Intersection (Room 3, Panel 4) – Roof to Floor

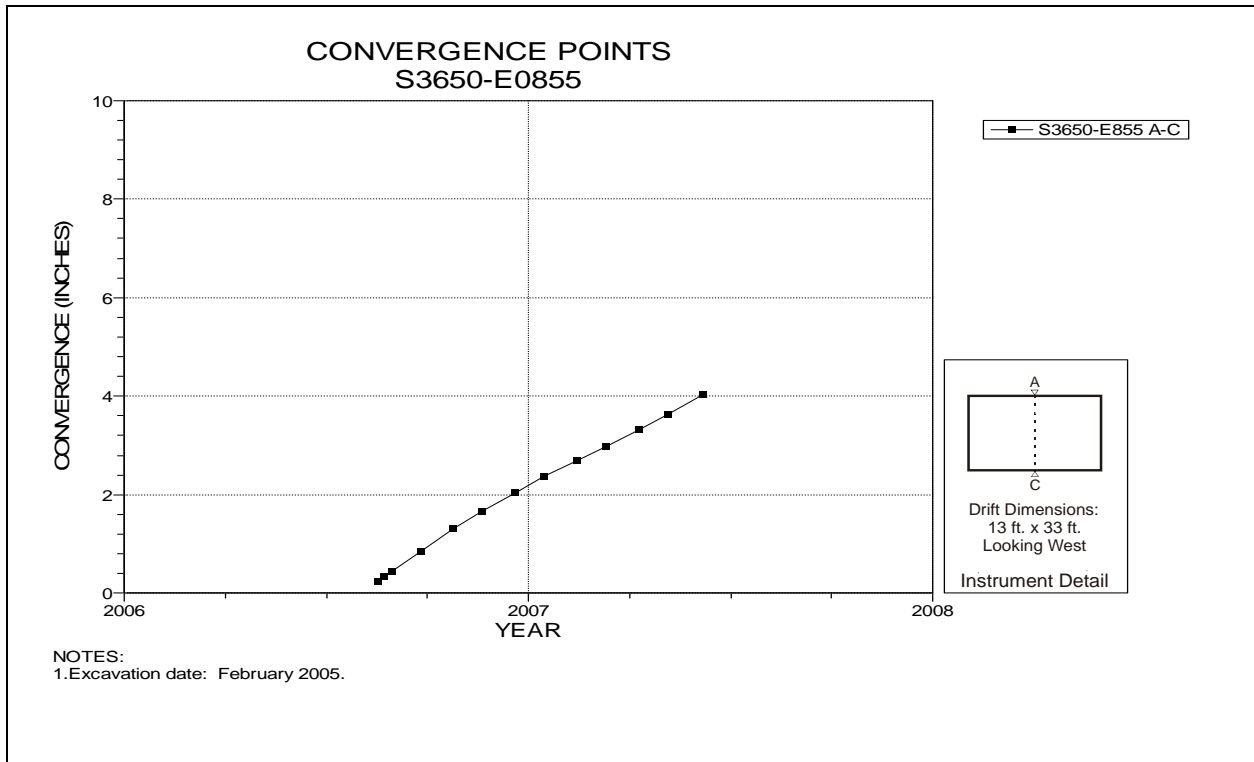


Figure 5-108 Convergence Point Array  
S3650 Drift at E855 – Roof to Floor

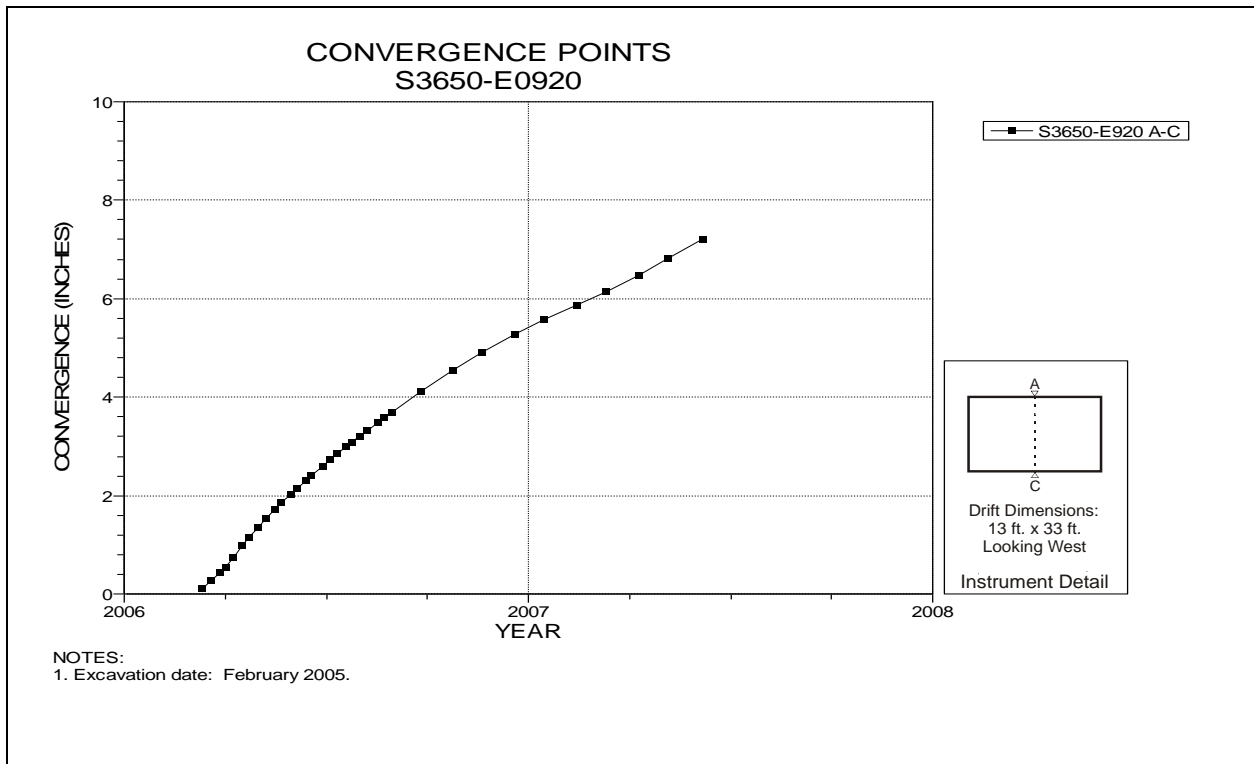


Figure 5-109 Convergence Point Array  
S3650 Drift at E920 Drift Intersection (Room 4, Panel 4) – Roof to Floor

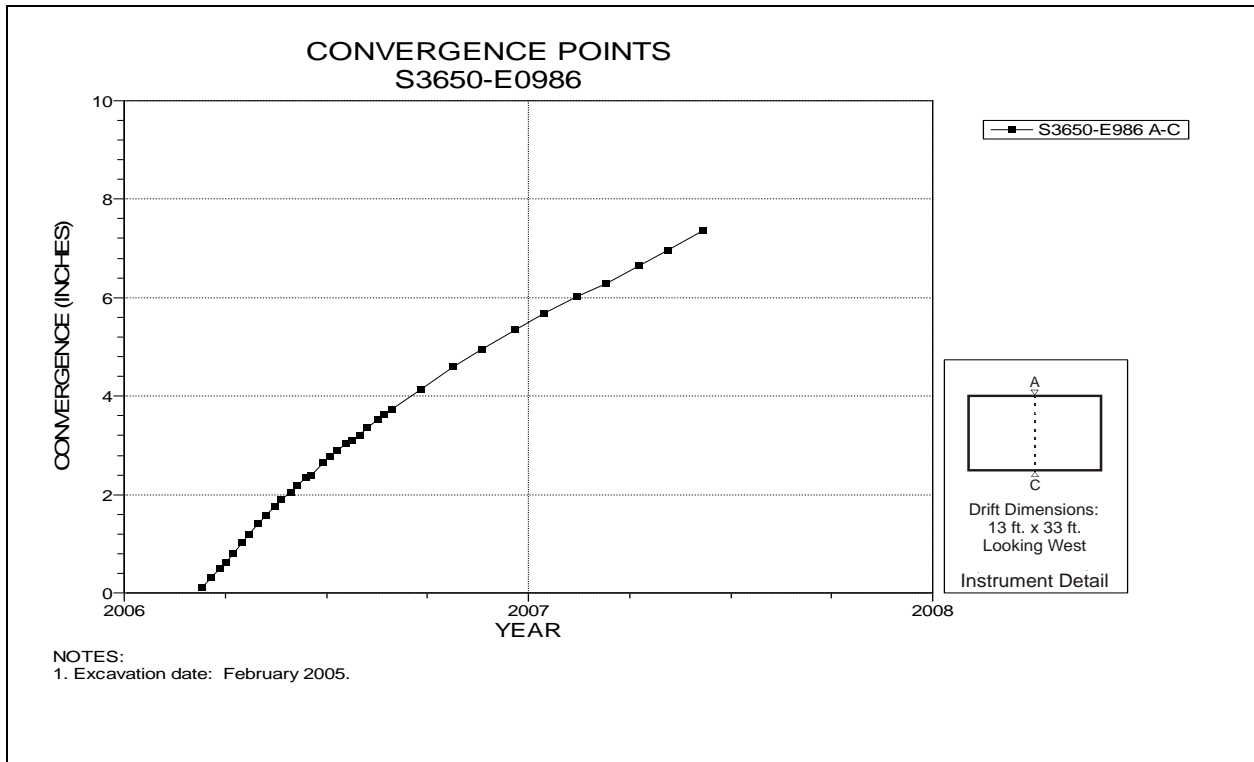


Figure 5-110 Convergence Point Array  
S3650 Drift at E 986 – Roof to Floor

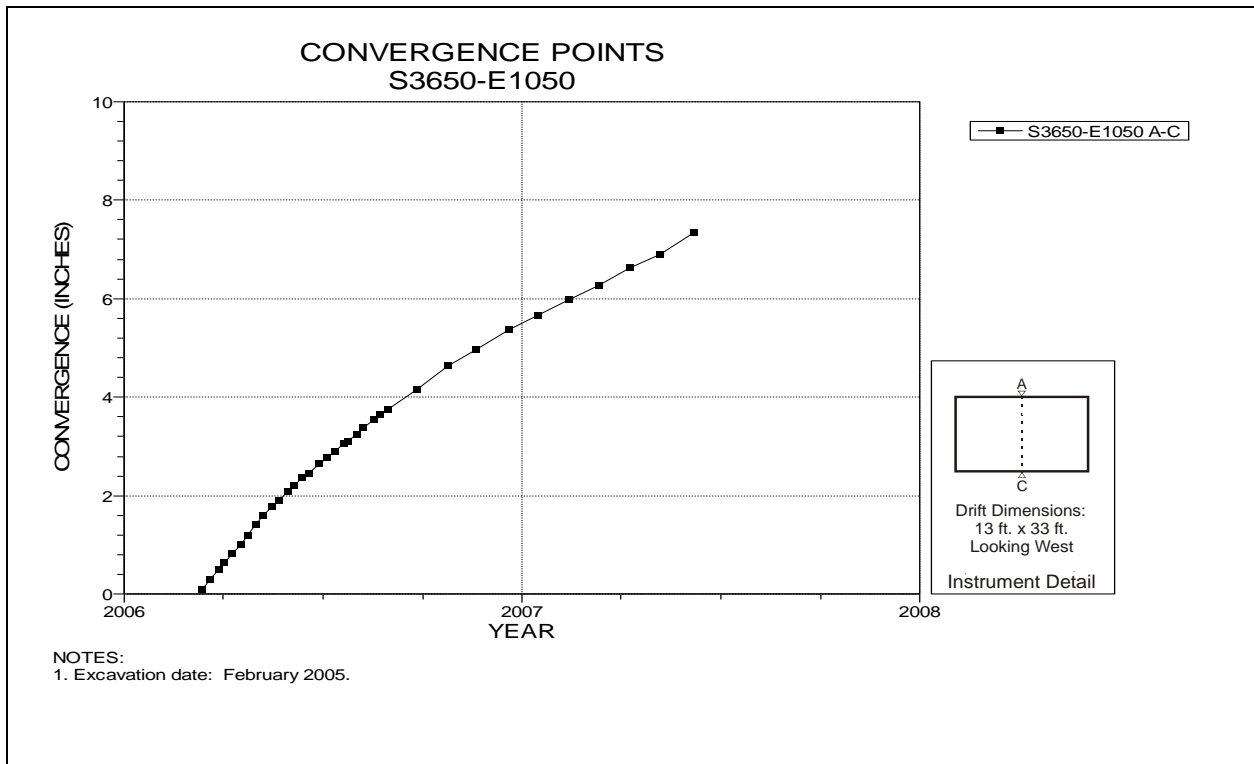


Figure 5-111 Convergence Point Array  
S3650 Drift at E1050 Drift Intersection (Room 5, Panel 4) – Roof to Floor



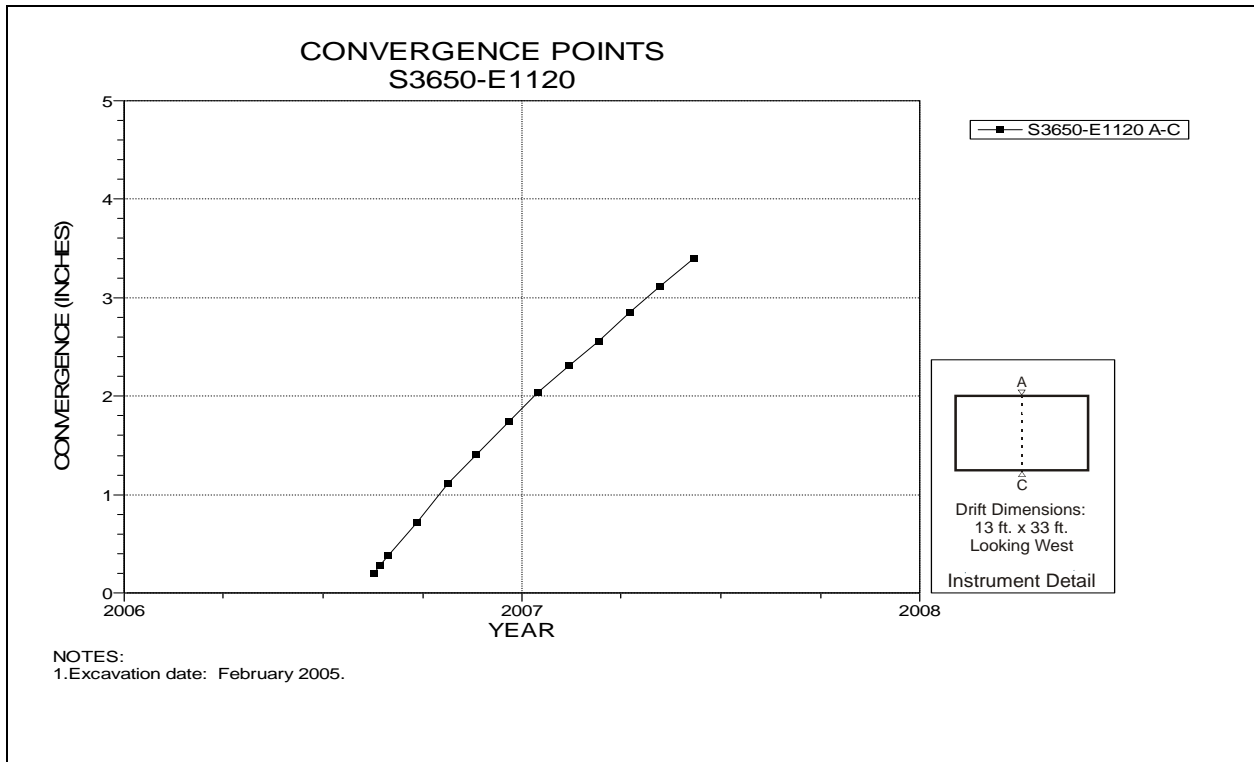


Figure 5-112 Convergence Point Array  
S3650 Drift at E1120 – Roof to Floor

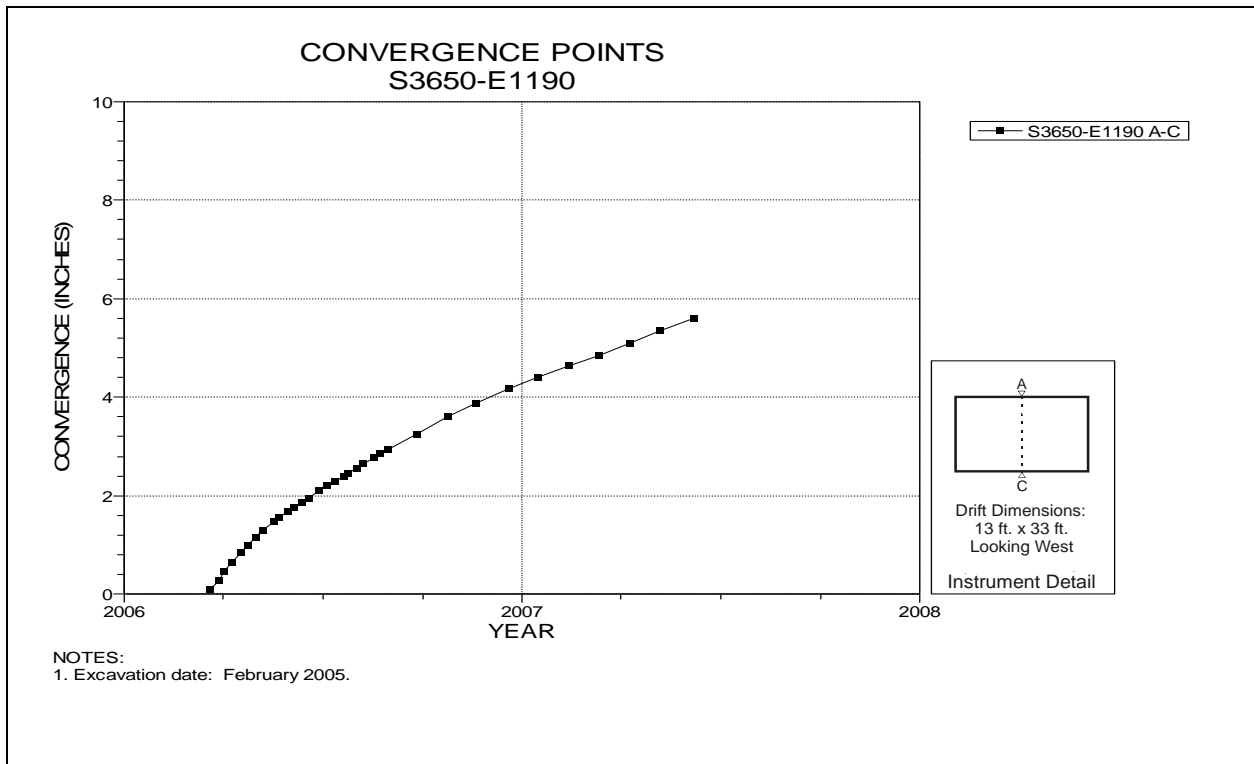


Figure 5-113 Convergence Point Array  
S3650 Drift at E1190 Drift Intersection (Room 6, Panel 4) – Roof to Floor

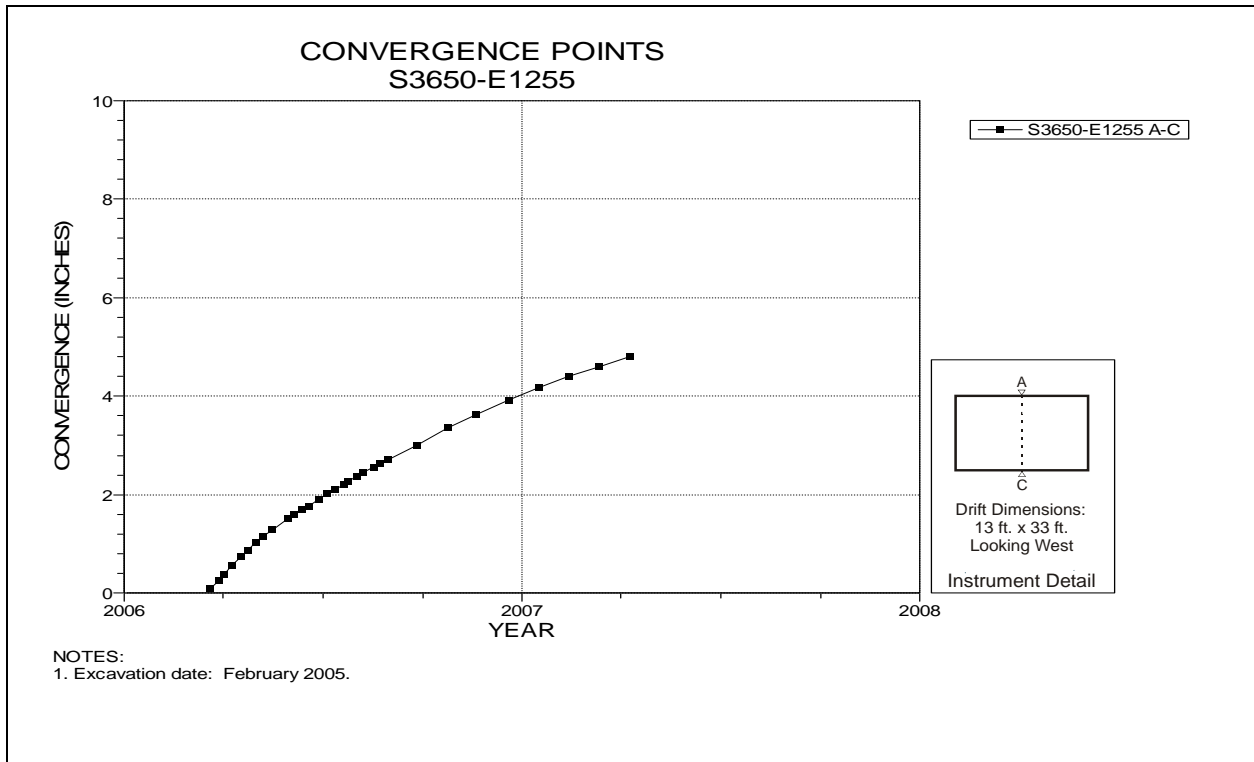


Figure 5-114 Convergence Point Array  
S3650 Drift at E1255 – Roof to Floor

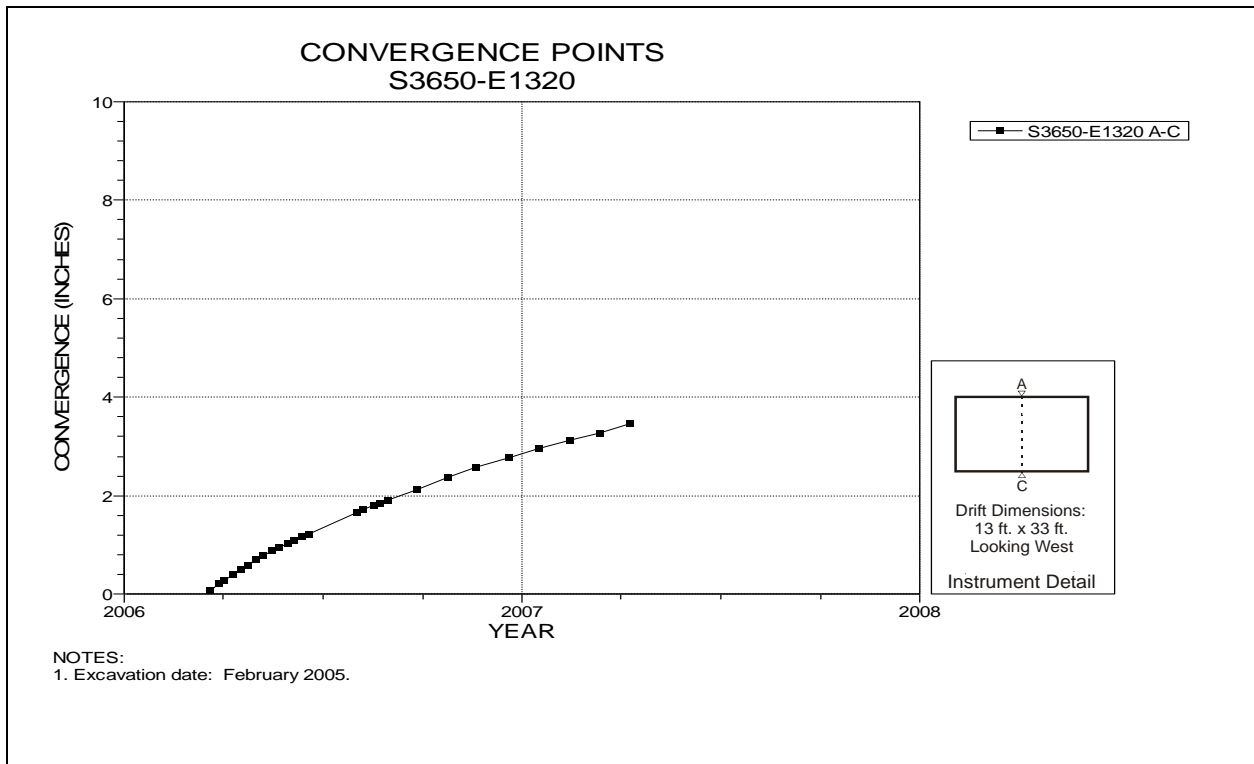


Figure 5-115 Convergence Point Array  
S3650 Drift at E1320 Drift Intersection (Room 7, Panel 4) – Roof to Floor

This page is intentionally blank.

**Table 5-5  
Panel 5 Data Analysis**

**EXTENSOMETERS**

Field Tag	Location	Figure Number	Date of Last Reading	Collar Displacement Relative to Deepest Anchor (inches)	Displacement Rate 2006 to 2007 (in/year)	Displacement Rate 2005 to 2006 <sup>1</sup> (in/year)	Rate Change Percent <sup>1</sup>	Comments
51X-GE-00389	W390-S3480	5-116	06/26/07	0.962	2.51	N/A	N/A	Not installed 2005-2006.
51X-GE-00390	W520-S3480	5-117	06/26/07	1.004	2.59	N/A	N/A	Not installed 2005-2006.

**CONVERGENCE POINTS**

Field Tag	Location	Figure Number	Last Reading 2006 to 2007		Cumulative Displacement (inches)	Closure Rate 2006 to 2007 (in/year)	Closure Rate 2005 to 2006 <sup>1</sup> (in/year)	Rate Change Percent <sup>1</sup>	Comments
			Date	Inches					
S3310-W285 A-C	S3310-W285	5-118	06/26/07	0.338	0.338	2.48	N/A	N/A	
S3310-W390 A-C	S3310-W390	5-119	06/26/07	1.607	1.607	4.41	N/A	N/A	
S3310-W520 A-C	S3310-W520	5-120	06/26/07	3.006	3.006	6.58	N/A	N/A	
S3310-W590 A-C	S3310-W590	5-121	06/26/07	1.610	1.610	5.80	N/A	N/A	
S3310-W660 A-C	S3310-W660	5-122	06/26/07	1.895	1.895	6.52	N/A	N/A	
S3310-W725 A-C	S3310-W725	5-123	06/26/07	2.121	2.121	7.49	N/A	N/A	
S3310-W790 A-C	S3310-W790	5-124	06/26/07	2.498	2.498	8.70	N/A	N/A	
S3310-W855 A-C	S3310-W855	5-125	06/26/07	2.909	2.909	10.50	N/A	N/A	
S3310-W920 A-C	S3310-W920	5-126	06/26/07	4.095	4.095	15.36	N/A	N/A	
S3310-W985 A-C	S3310-W985	5-127	06/26/07	3.488	3.488	13.06	N/A	N/A	
S3310-W1050 A-C	S3310-W1050	5-128	06/26/07	2.774	2.774	17.08	N/A	N/A	
S3310-W1120 A-C	S3310-W1120	5-129	06/26/07	2.127	2.127	15.97	N/A	N/A	
S3310-W1190 A-C	S3310-W1190	5-130	06/26/07	2.755	2.755	22.93	N/A	N/A	
S3650-W390-2 A-C	S3650 DRIFT-W390	5-131	06/26/07	3.495	5.092	5.46	N/A	N/A	
S3650-W456-2 A-C	S3650 DRIFT-W456	5-132	06/26/07	2.134	3.540	4.81	N/A	N/A	
S3650-W520 A-C	S3650 DRIFT-W520	5-133	06/26/07	6.413	6.413	7.65	N/A	N/A	

<sup>1</sup> NA indicates insufficient data to compare annualized rates. These instruments were not installed during the 2005-2006 reporting period.

**Table 5-5 (Continued)  
Panel 5 Data Analysis**

**CONVERGENCE POINTS (Continued)**

Field Tag	Location	Figure Number	Last Reading 2006 to 2007		Cumulative Displacement (inches)	Closure Rate 2006 to 2007 (in/year)	Closure Rate 2005 to 2006 <sup>1</sup> (in/year)	Rate Change Percent <sup>1</sup>	Comments
			Date	Inches					
S3650-W585 A-C	S3650-W585	5-134	06/26/07	6.320	6.320	8.38	N/A	N/A	
S3650-W660 A-C	S3650-W660	5-135	06/26/07	3.563	3.563	8.08	N/A	N/A	
S3650-W725 A-C	S3650-W725	5-136	06/26/07	3.230	3.230	8.43	N/A	N/A	
S3650-W790 A-C	S3650-W790	5-137	06/26/07	3.386	3.386	12.14	N/A	N/A	
S3650-W855 A-C	S3650-W855	5-138	06/26/07	3.402	3.402	12.24	N/A	N/A	
W390-S3395-2 A-C	W390-S3395	5-139	06/26/07	4.936	6.586	7.60	N/A	N/A	
W390-S3480-2 A-C	W390-S3480	5-140	06/26/07	4.905	6.121	7.65	N/A	N/A	
W390-S3565-2 A-C	W390-S3565	5-141	06/26/07	4.330	5.266	6.79	N/A	N/A	
W520-S3395 A-C	W520-S3395	5-142	06/26/07	3.159	3.159	7.09	N/A	N/A	
W520-S3480 A-C	W520-S3480	5-143	06/26/07	3.265	3.265	7.36	N/A	N/A	
W520-S3565 A-C	W520-S3565	5-144	06/26/07	3.121	3.121	7.03	N/A	N/A	
W660-S3395 A-C	W660-S3395	5-145	06/26/07	2.418	2.418	7.80	N/A	N/A	
W660-S3480 A-C	W660-S3480	5-146	06/26/07	2.622	2.622	8.49	N/A	N/A	
W660-S3565 A-C	W660-S3565	5-147	06/26/07	2.553	2.553	8.29	N/A	N/A	
W790-S3395 A-C	W790-S3395	5-148	06/26/07	1.053	1.053	7.96	N/A	N/A	
W790-S3480 A-C	W790-S3480	5-149	06/26/07	1.097	1.097	8.24	N/A	N/A	
W790-S3565 A-C	W790-S3565	5-150	06/26/07	1.111	1.111	8.29	N/A	N/A	

<sup>1</sup> NA indicates insufficient data to compare annualized rates. These instruments were not installed during the 2005-2006 reporting period.

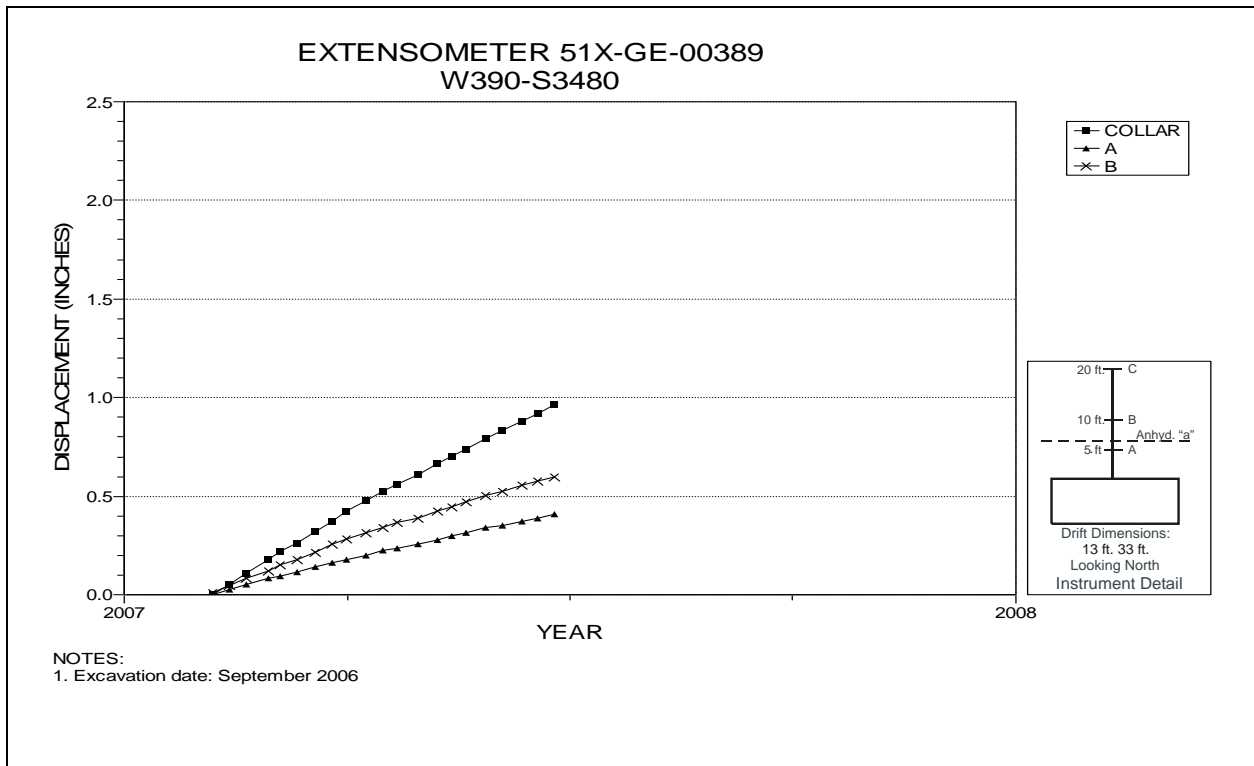


Figure 5-116 Extensometer 51X-GE-00389  
Room 1, Panel 5 – Room Center – Roof

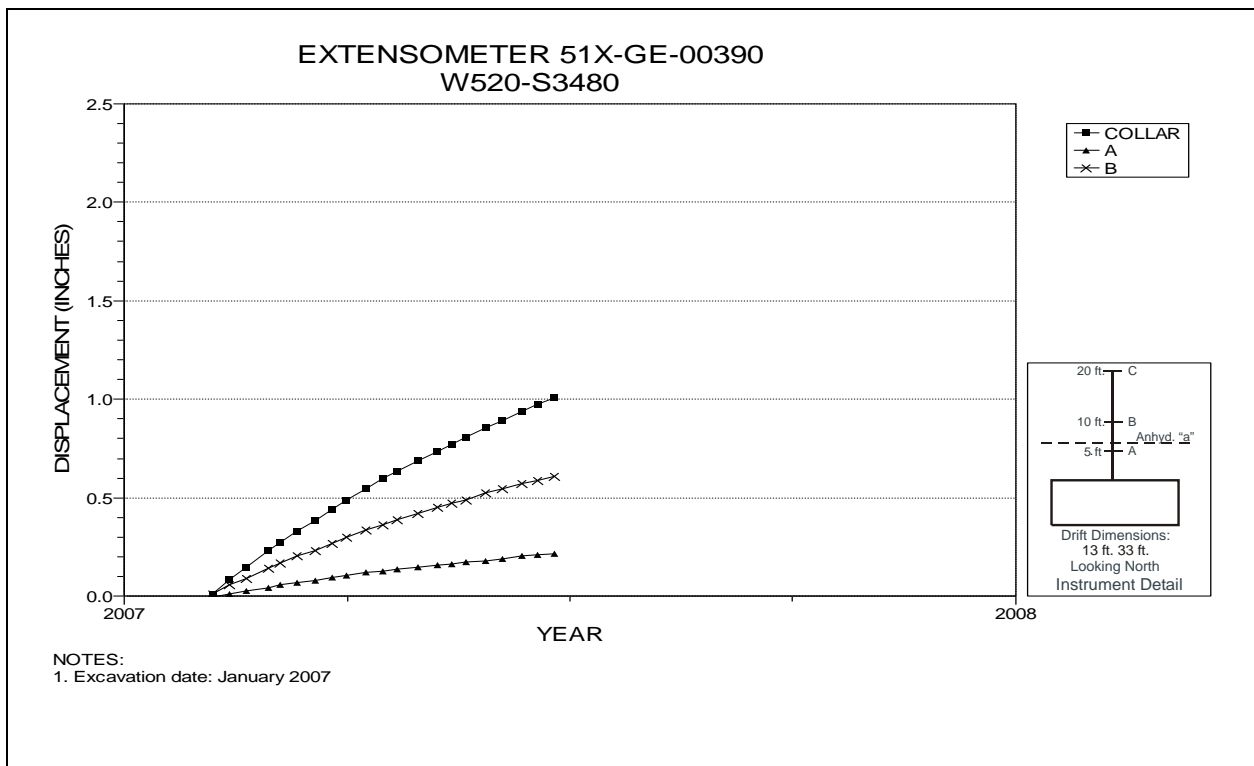


Figure 5-117 Extensometer 51X-GE-00390  
Room 2, Panel 5 – Room Center – Roof

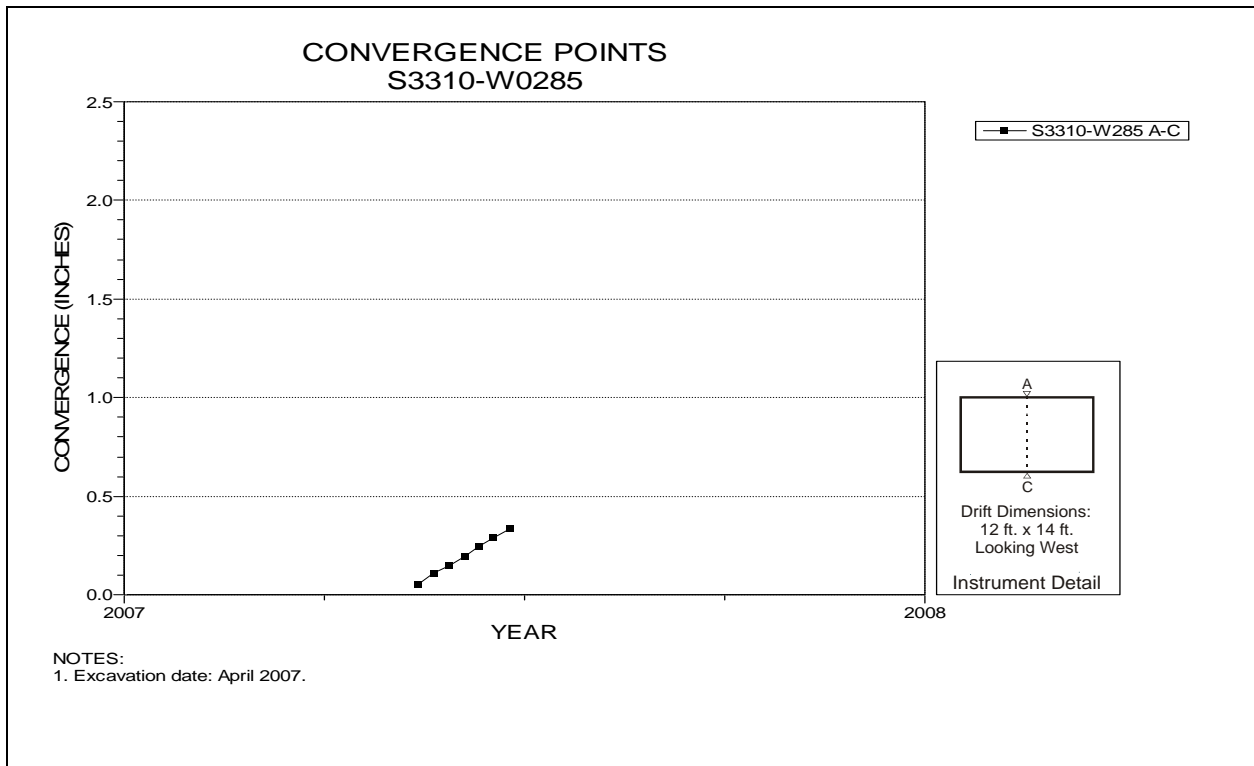


Figure 5-118 Convergence Point Array  
S3310 Drift at W285 – Roof to Floor

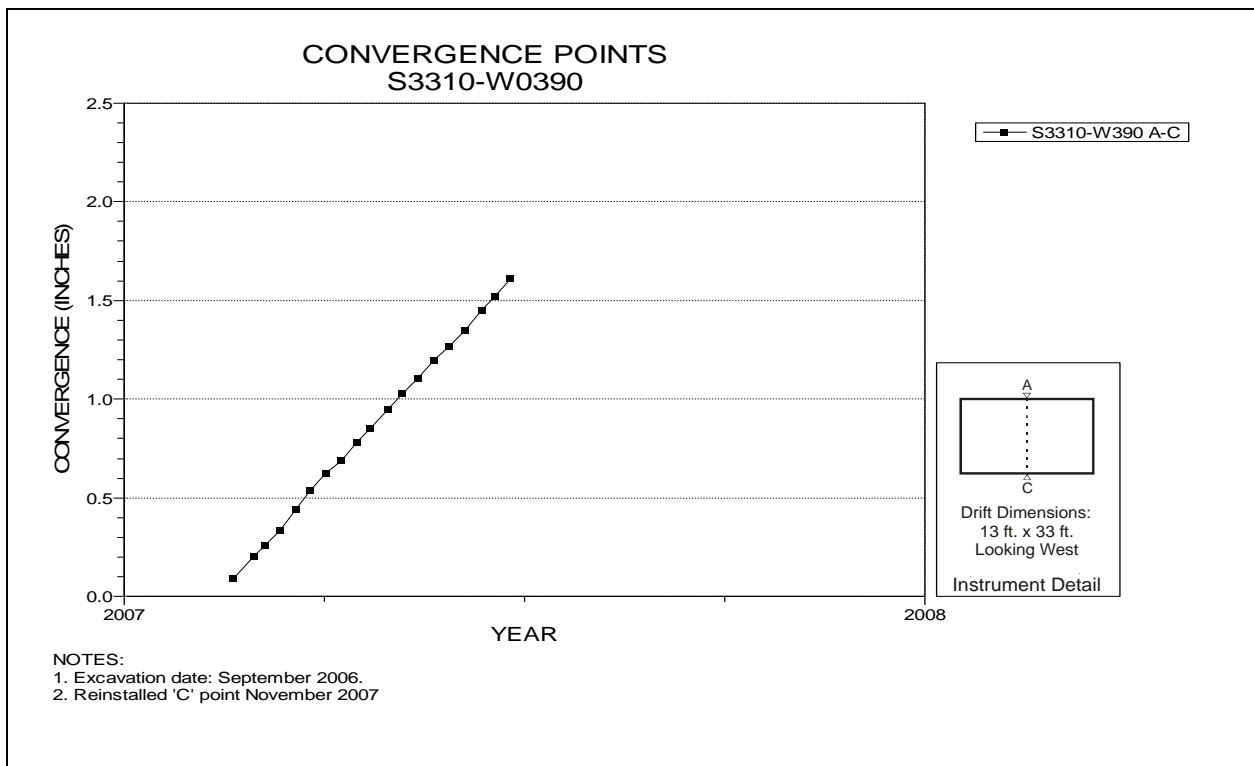


Figure 5-119 Convergence Point Array  
S3310 Drift at W390 Drift Intersection (Room 1, Panel 5) – Roof to Floor

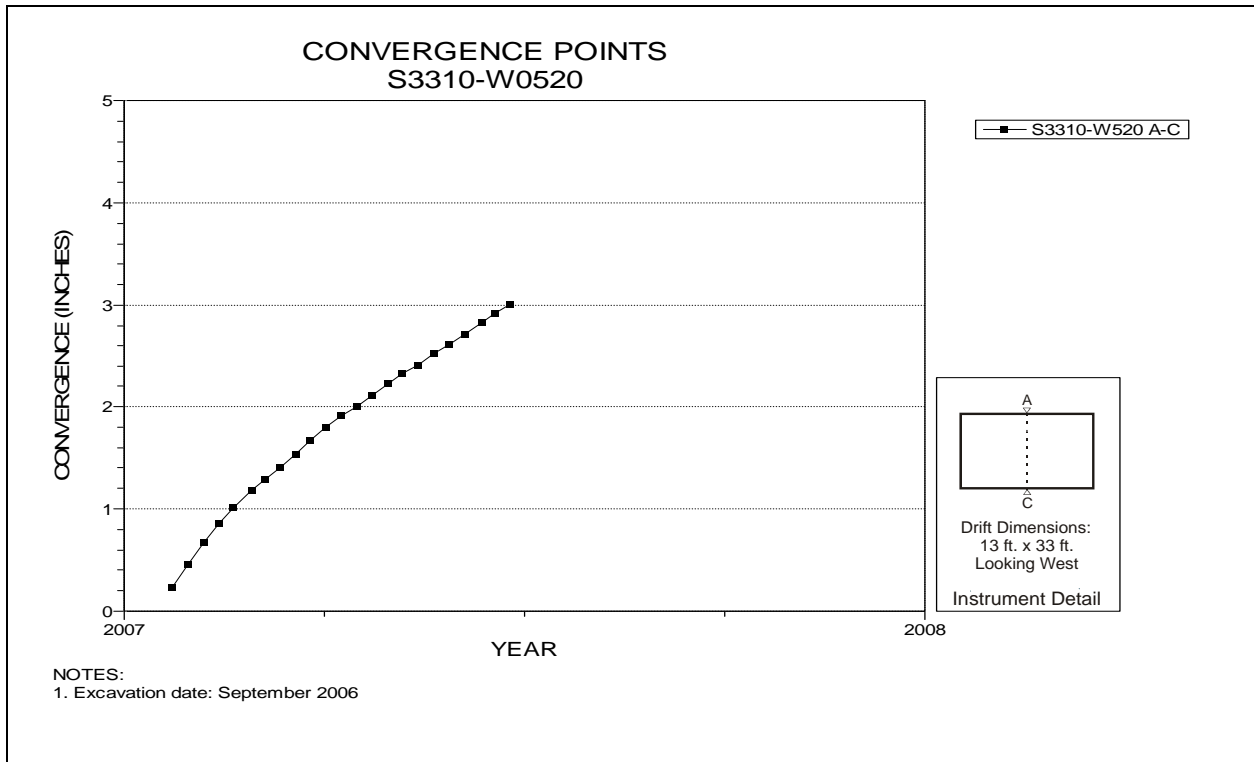


Figure 5-120 Convergence Point Array  
S3310 Drift at W520 Drift Intersection (Room 2, Panel 5) – Roof to Floor

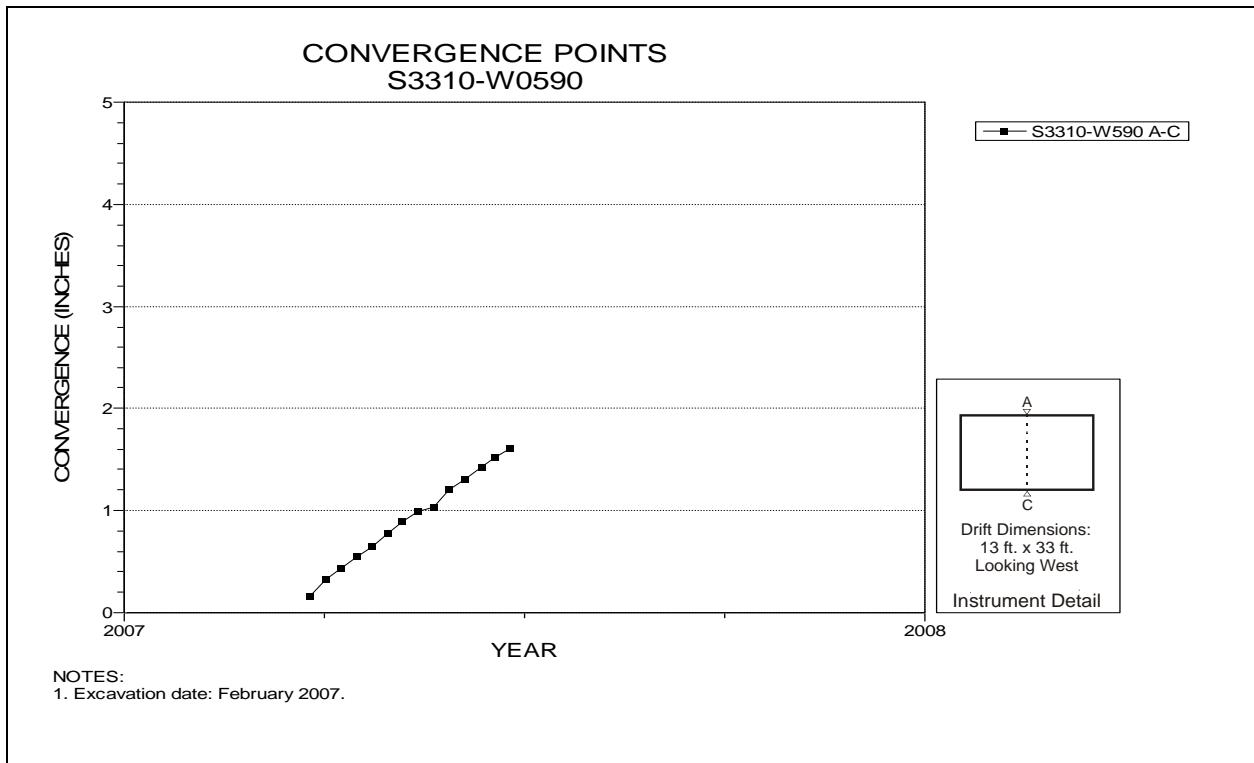


Figure 5-121 Convergence Point Array  
S3310 Drift at W590 – Roof to Floor



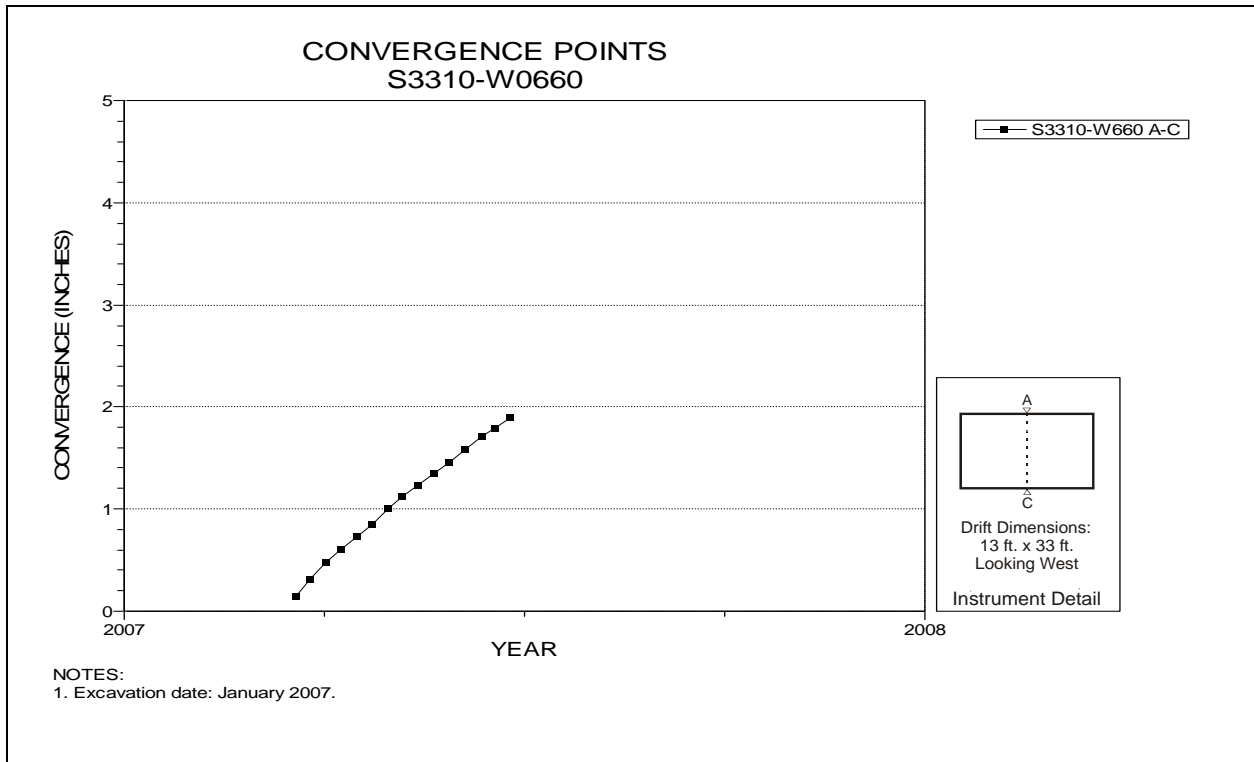


Figure 5-122 Convergence Point Array  
S3310 Drift at W660 Drift Intersection (Room 3, Panel 5) – Roof to Floor

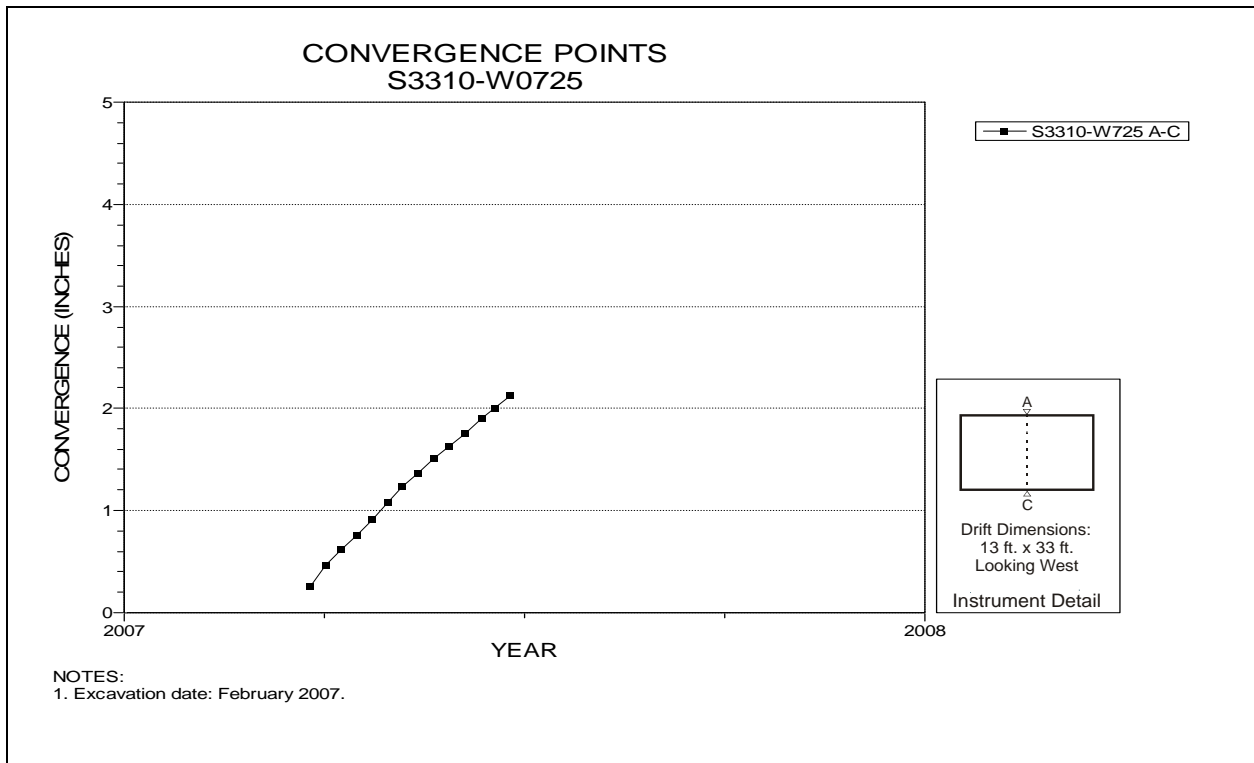


Figure 5-123 Convergence Point Array  
S3310 Drift at W725 – Roof to Floor

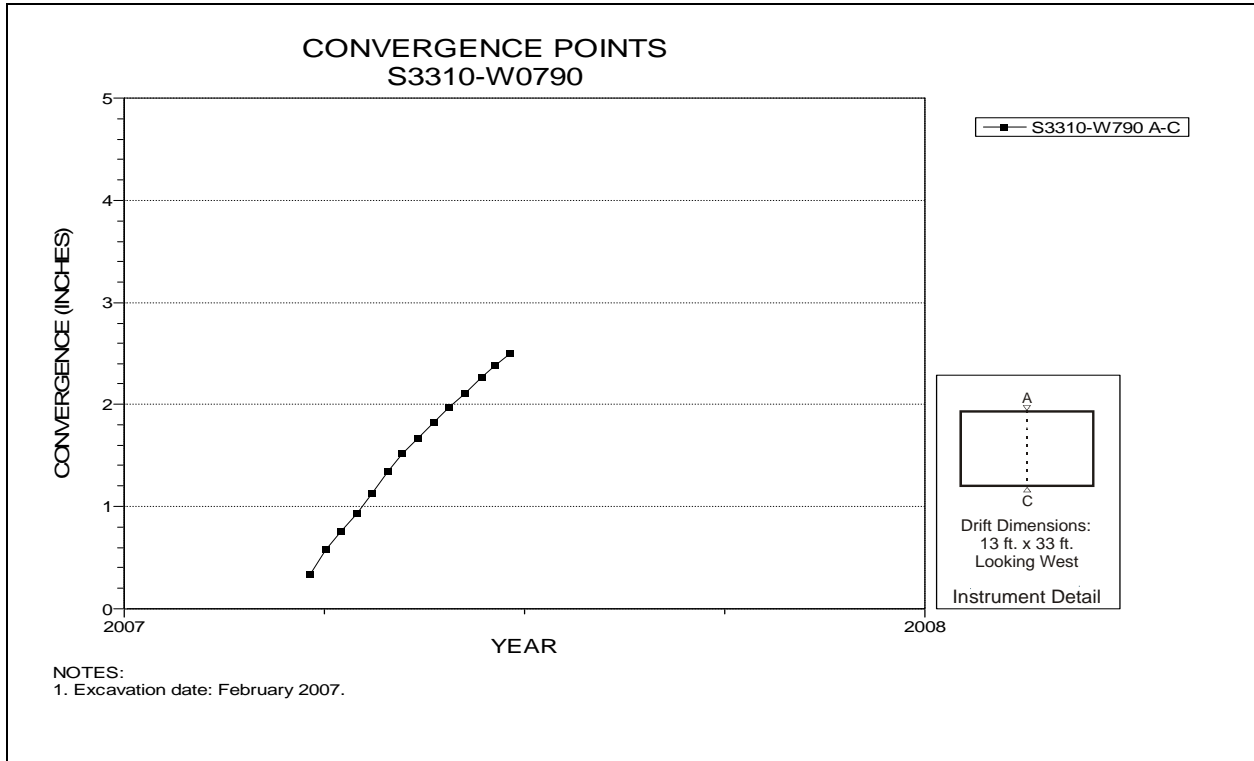


Figure 5-124 Convergence Point Array  
S3310 Drift at W790 Drift Intersection (Room 4, Panel 5) – Roof to Floor

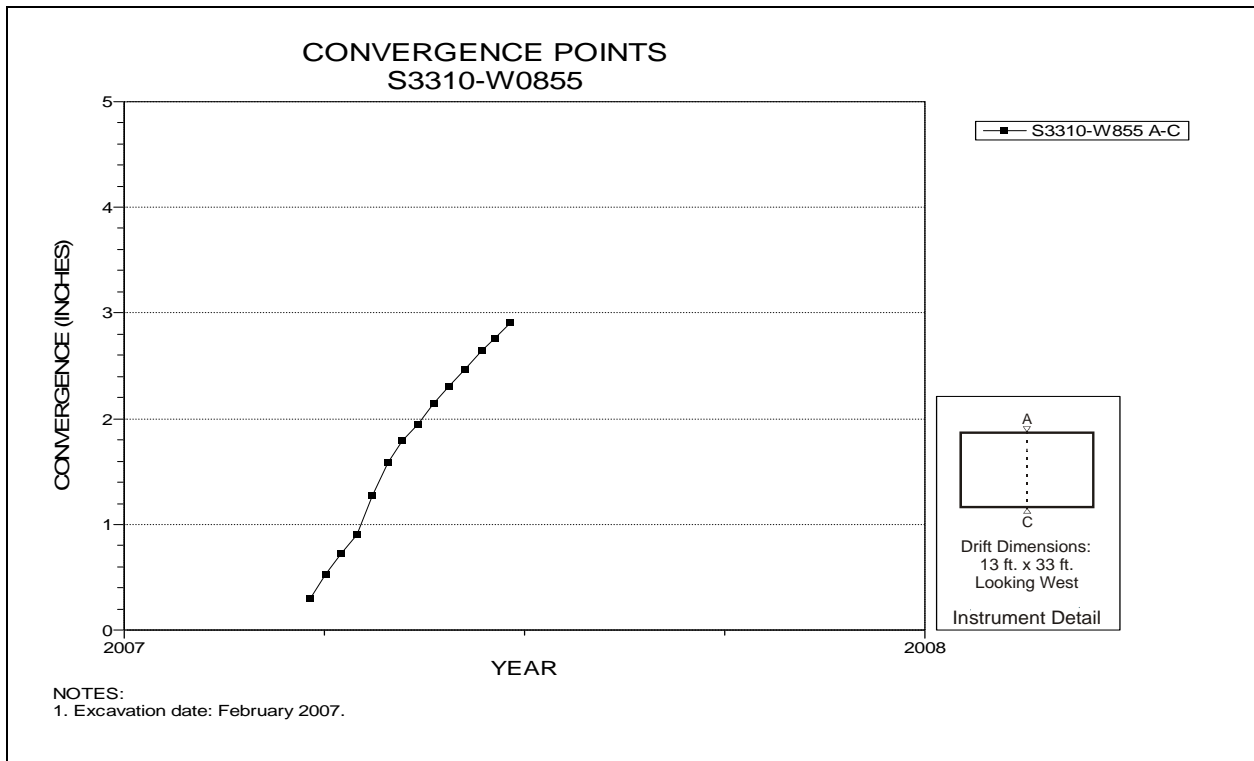


Figure 5-125 Convergence Point Array  
S3310 Drift at W855 – Roof to Floor

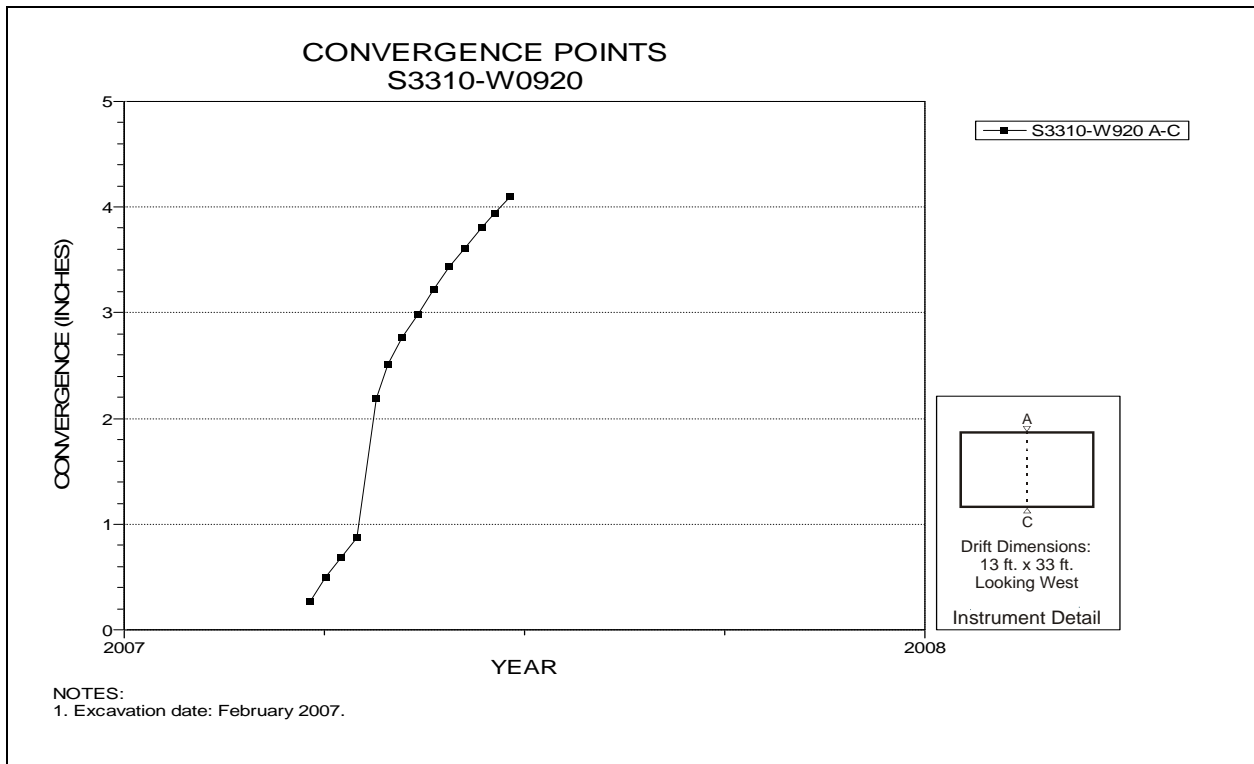


Figure 5-126 Convergence Point Array  
S3310 Drift at W920 Drift Intersection (Room 5, Panel 5) – Roof to Floor

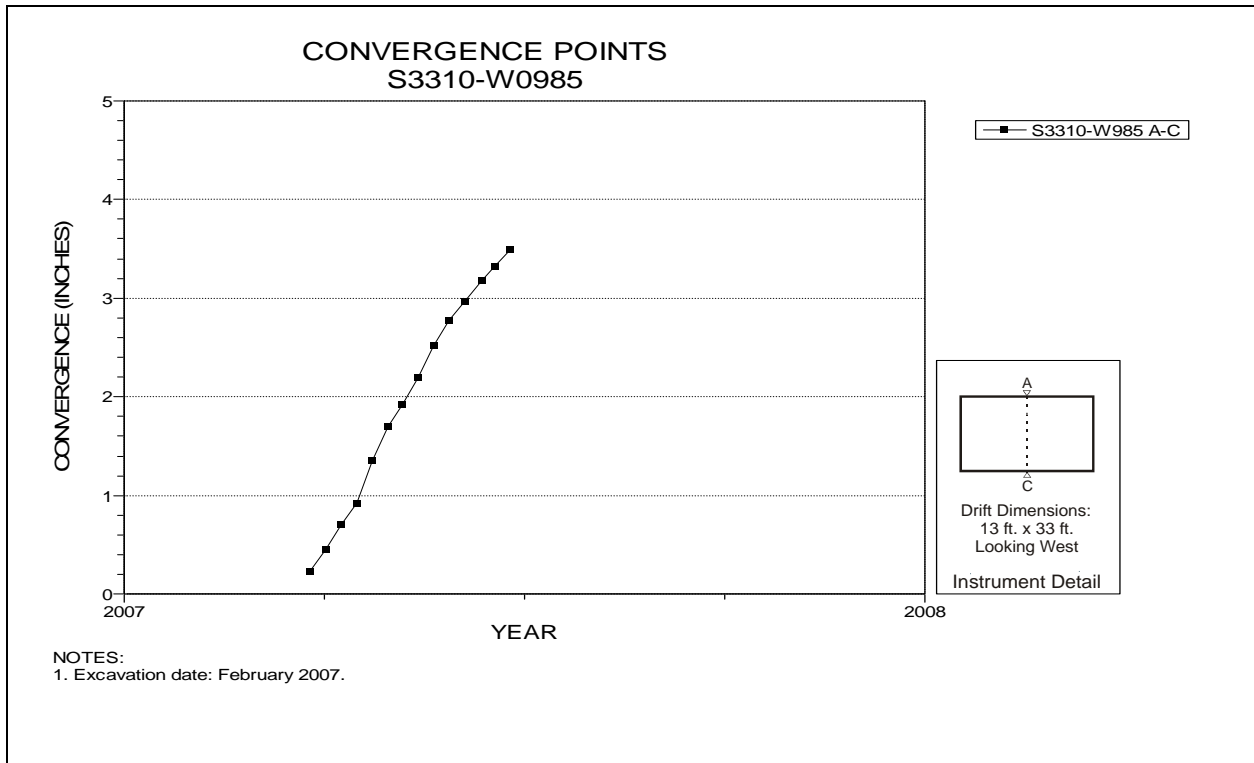


Figure 5-127 Convergence Point Array  
S3310 Drift at W985 – Roof to Floor

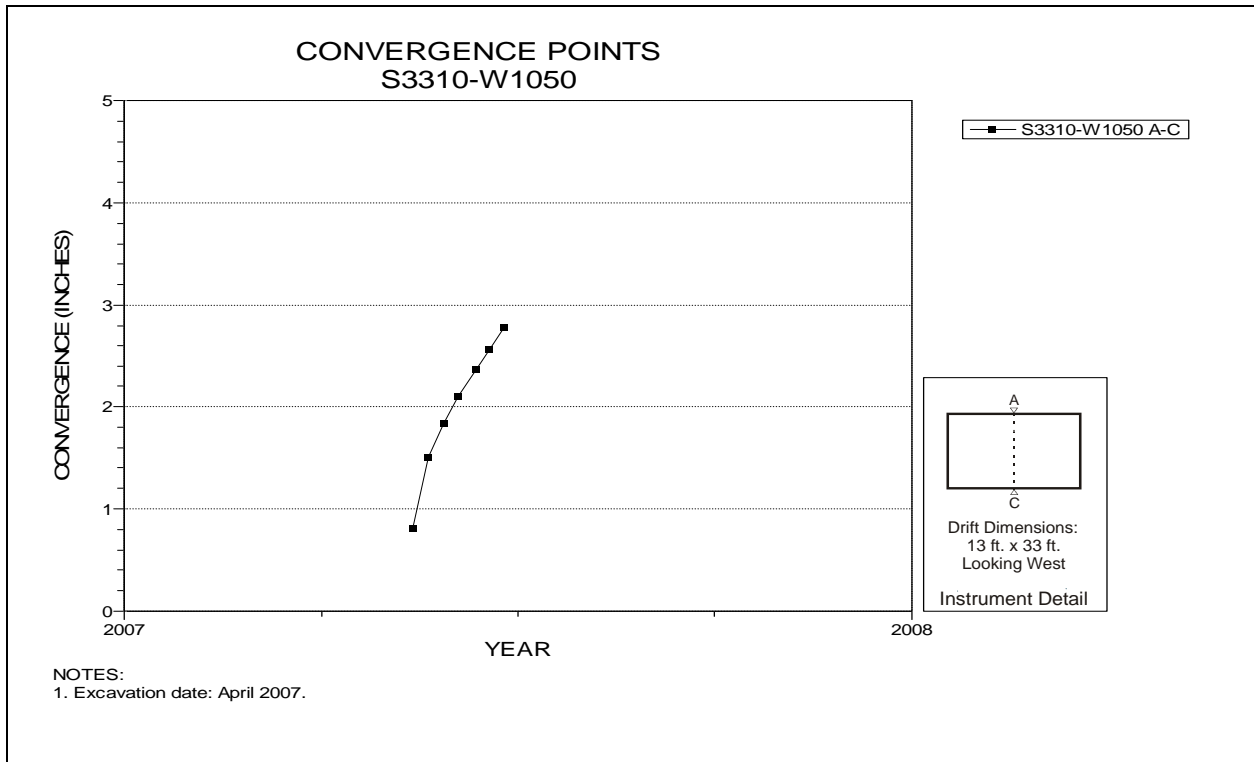


Figure 5-128 Convergence Point Array  
S3310 Drift at W1050 Drift Intersection (Room 6, Panel 5) – Roof to Floor

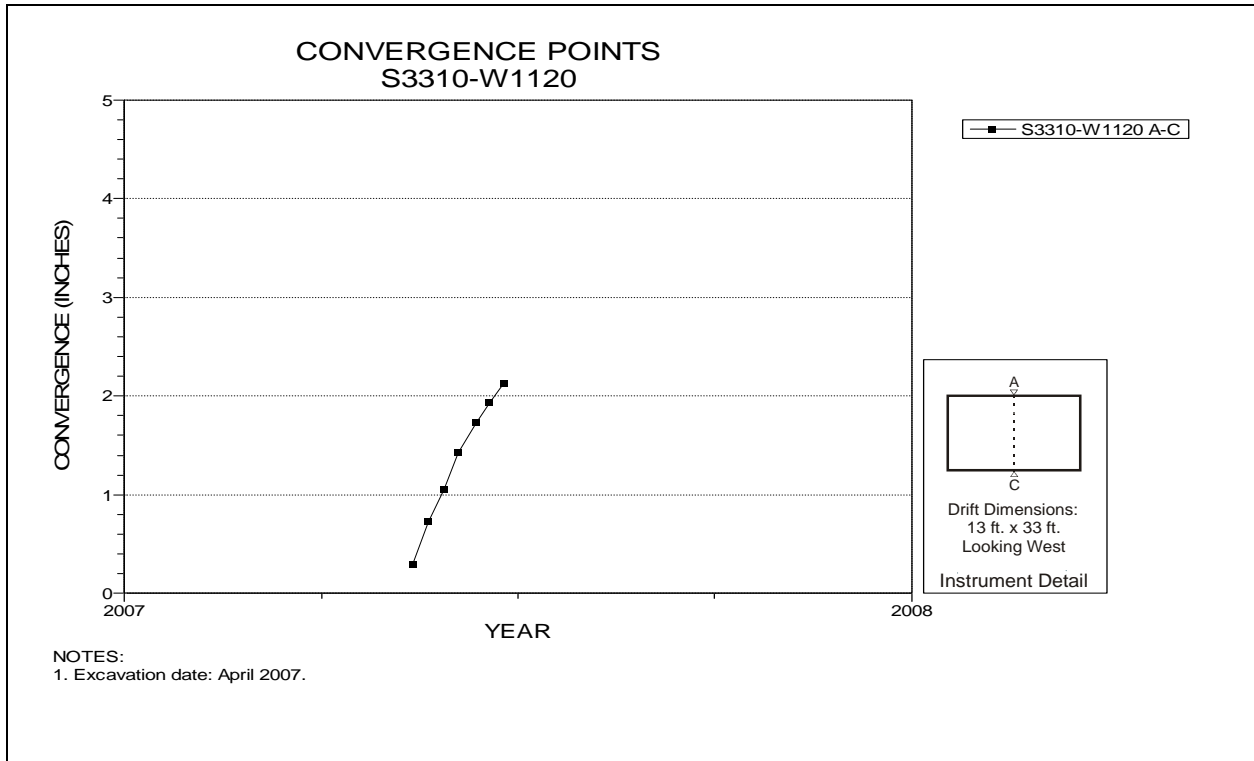


Figure 5-129 Convergence Point Array  
S3310 Drift at W1120 – Roof to Floor

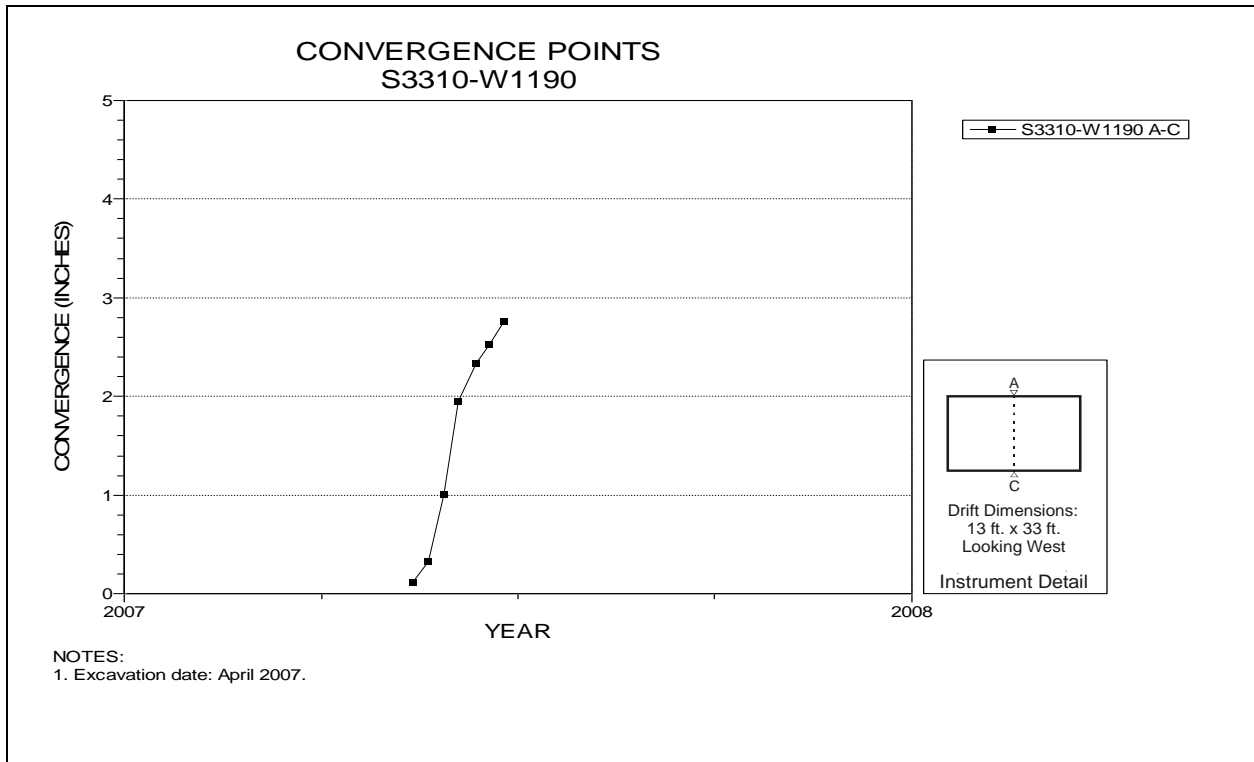


Figure 5-130 Convergence Point Array  
S3310 Drift at W1190 Drift Intersection (Room 7, Panel 5) – Roof to Floor

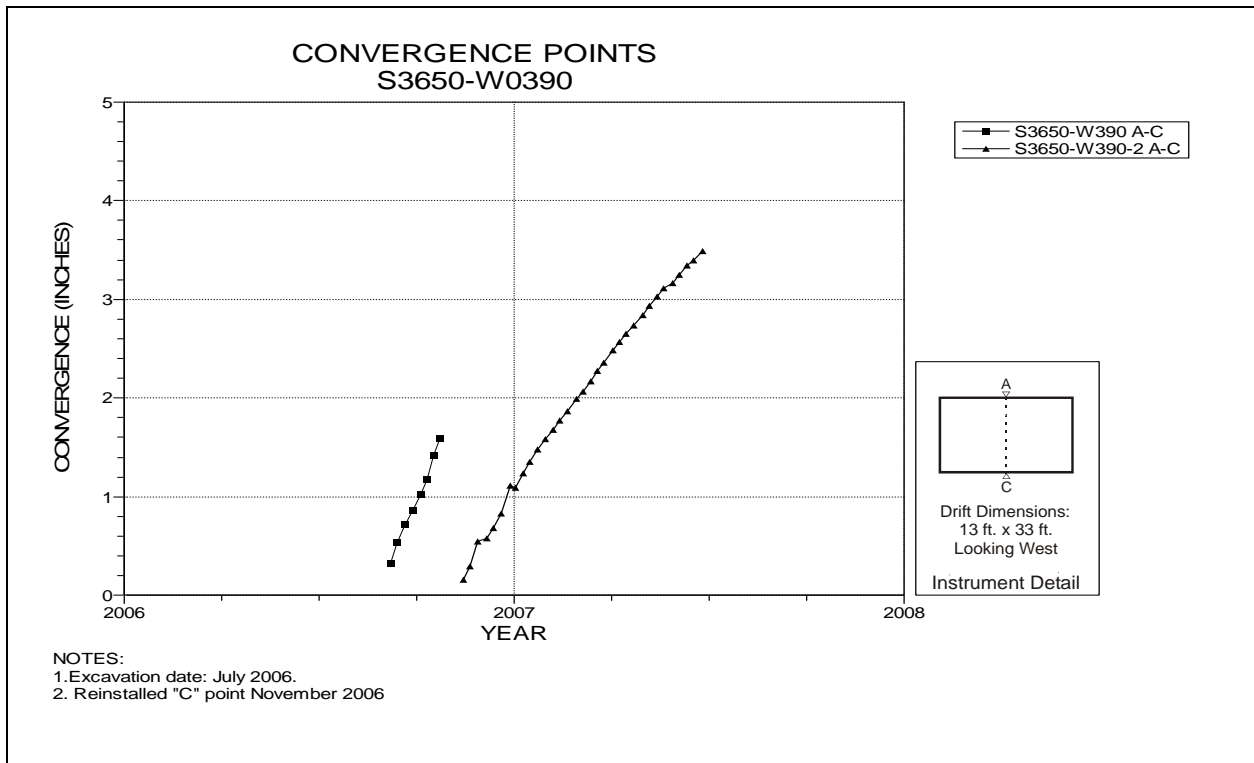


Figure 5-131 Convergence Point Array  
S3650 Drift at W390 Drift Intersection (Room 1, Panel 5) – Roof to Floor

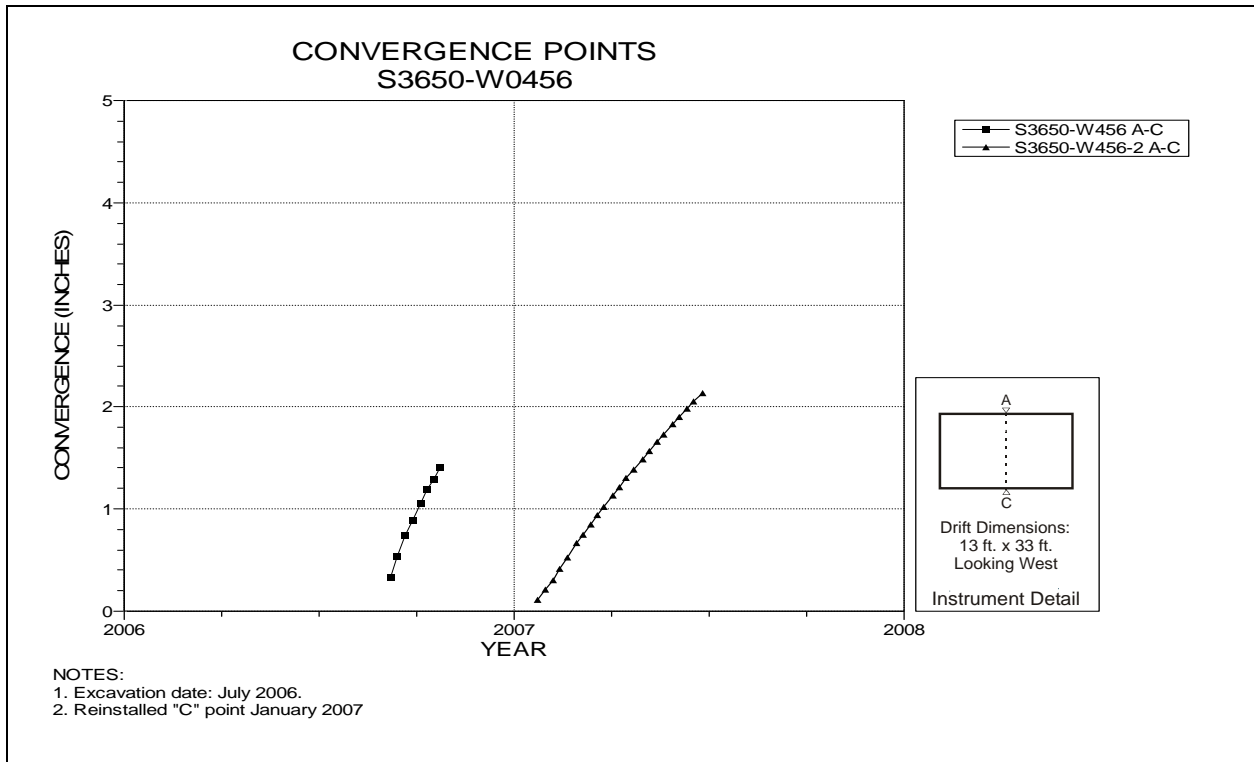


Figure 5-132 Convergence Point Array  
S3650 Drift at W456 – Roof to Floor

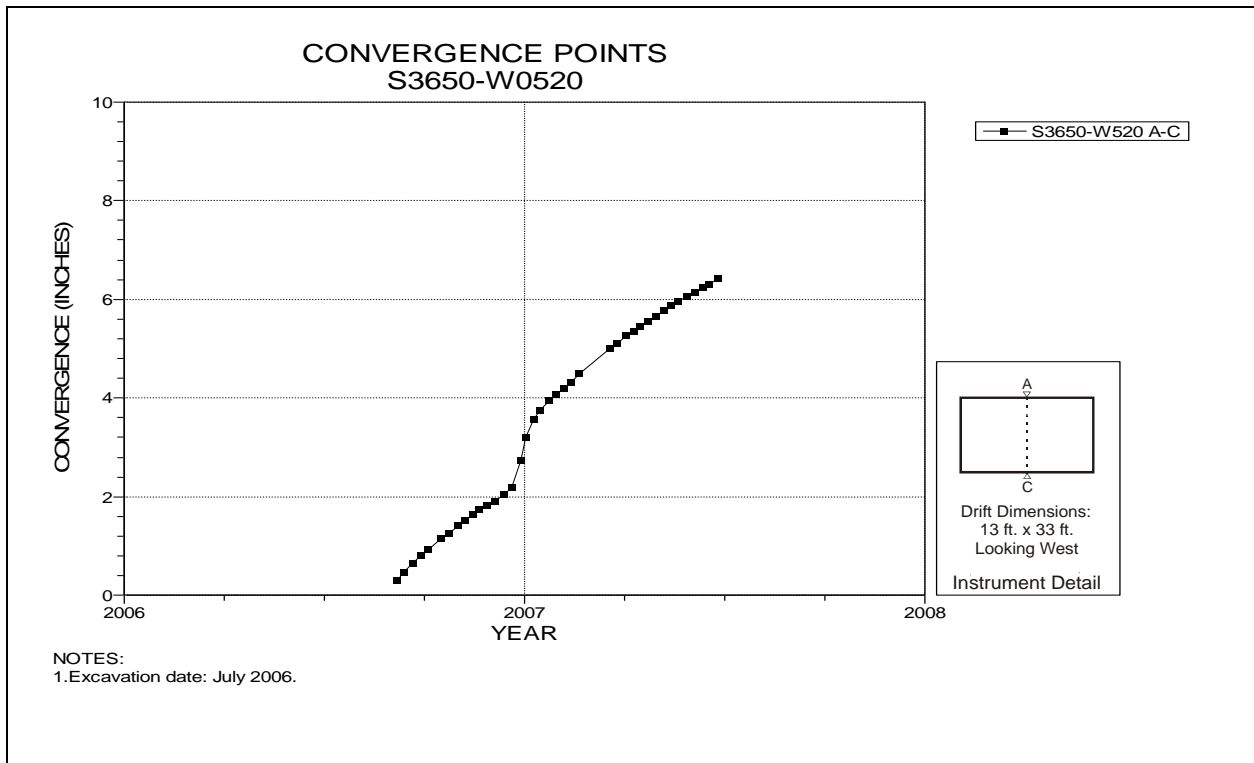


Figure 5-133 Convergence Point Array  
S3650 Drift at W520 Drift Intersection (Room 2, Panel 5) – Roof to Floor

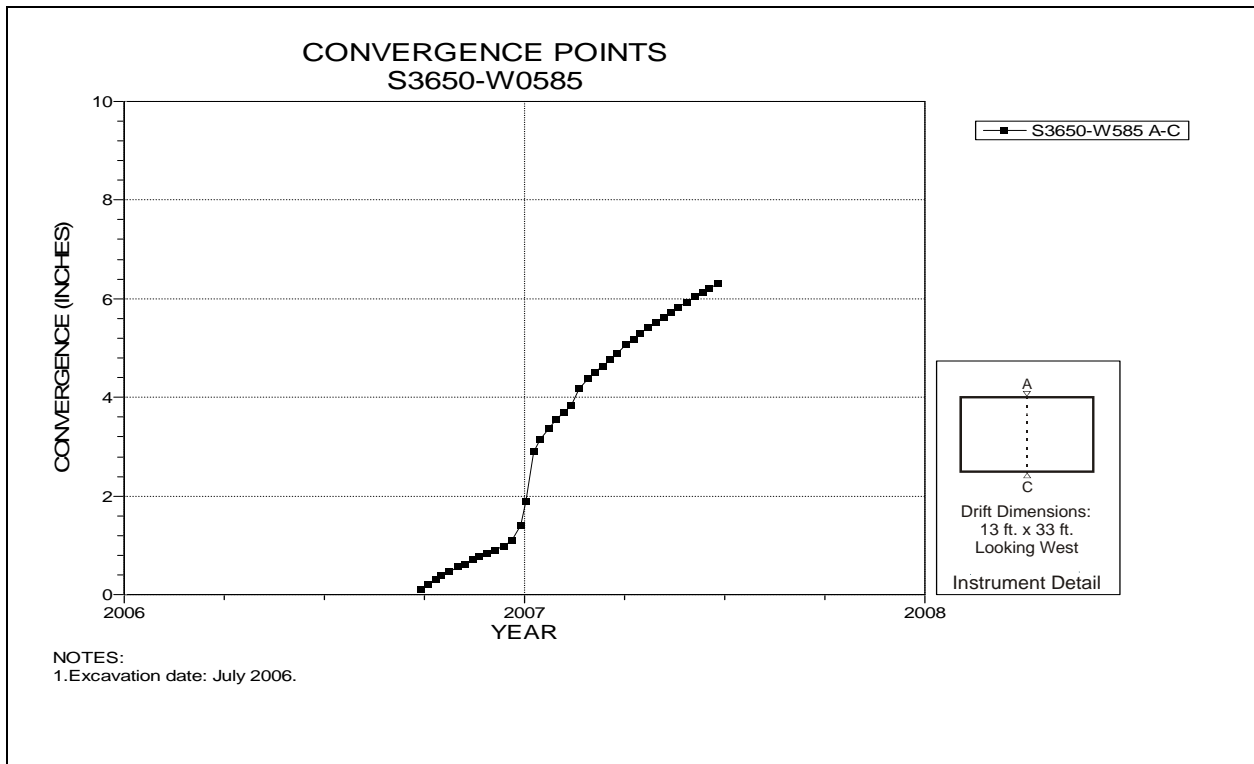


Figure 5-134 Convergence Point Array  
S3650 Drift at W585 – Roof to Floor

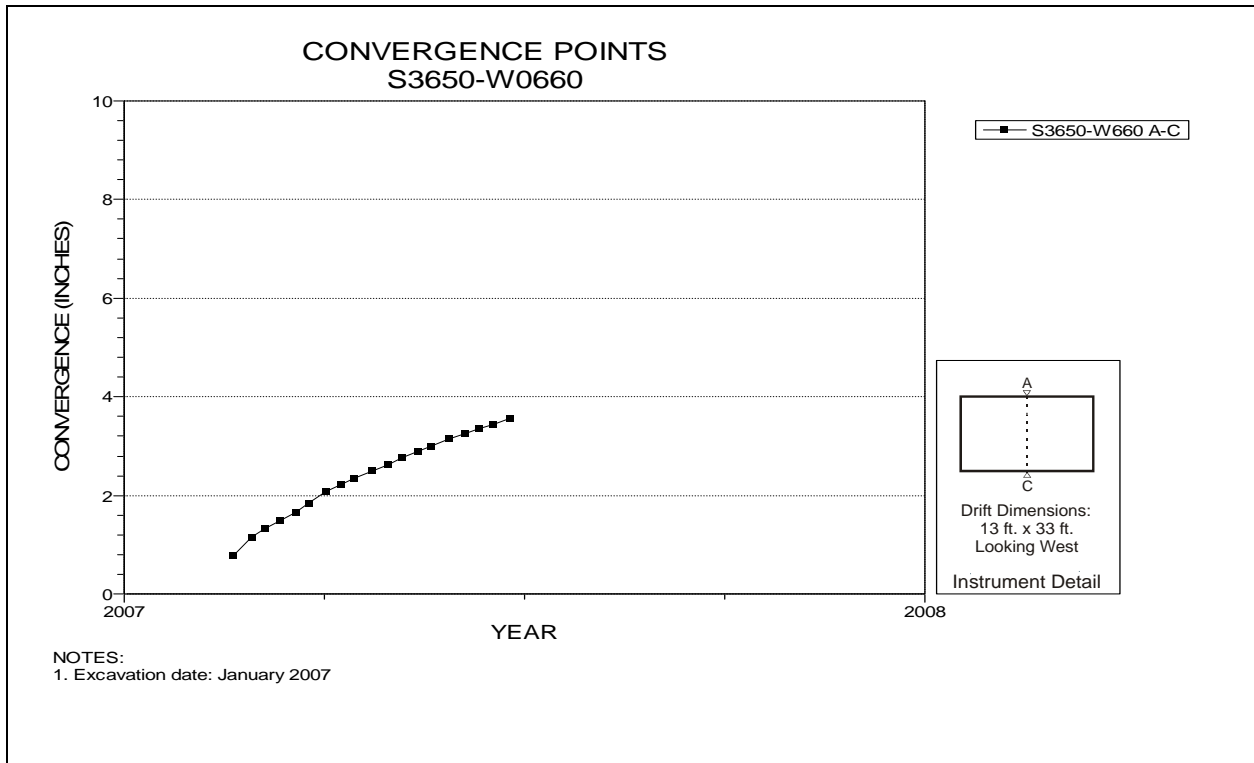


Figure 5-135 Convergence Point Array  
S3650 Drift at W660 Drift Intersection (Room 3, Panel 5) – Roof to Floor

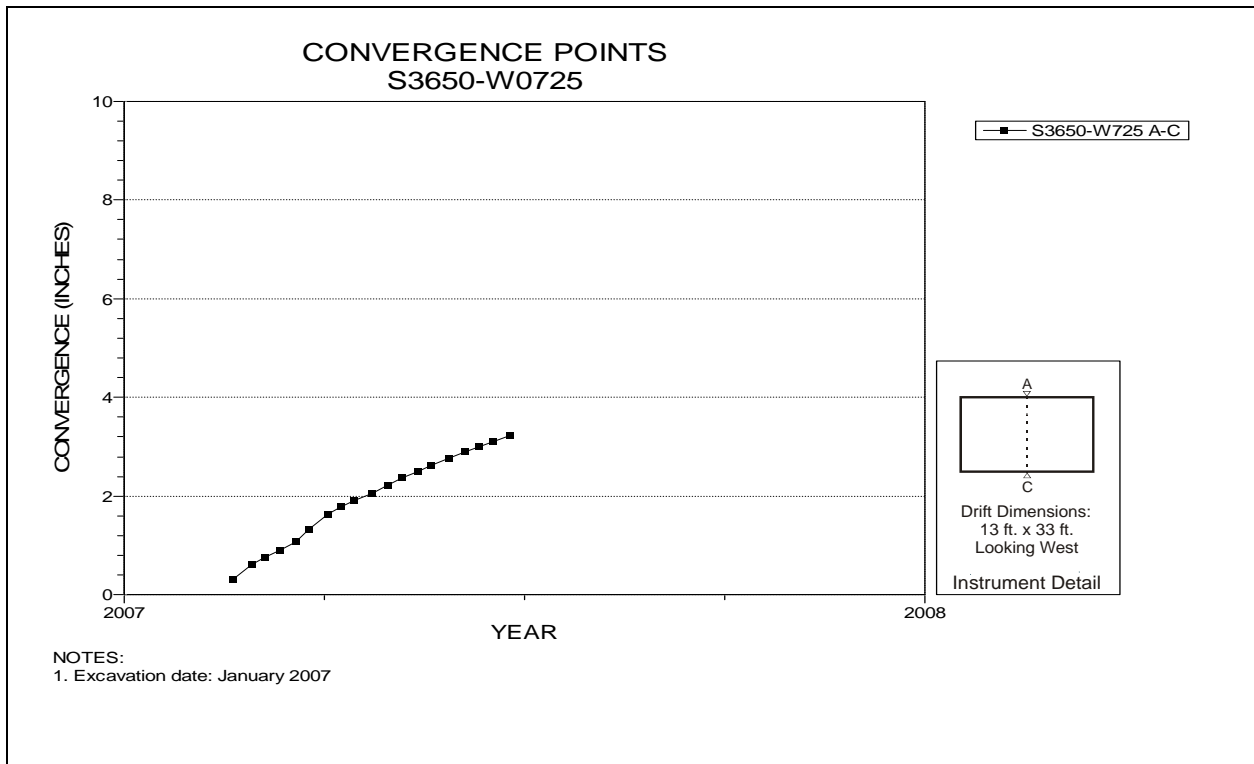


Figure 5-136 Convergence Point Array  
S3650 Drift at W725 – Roof to Floor

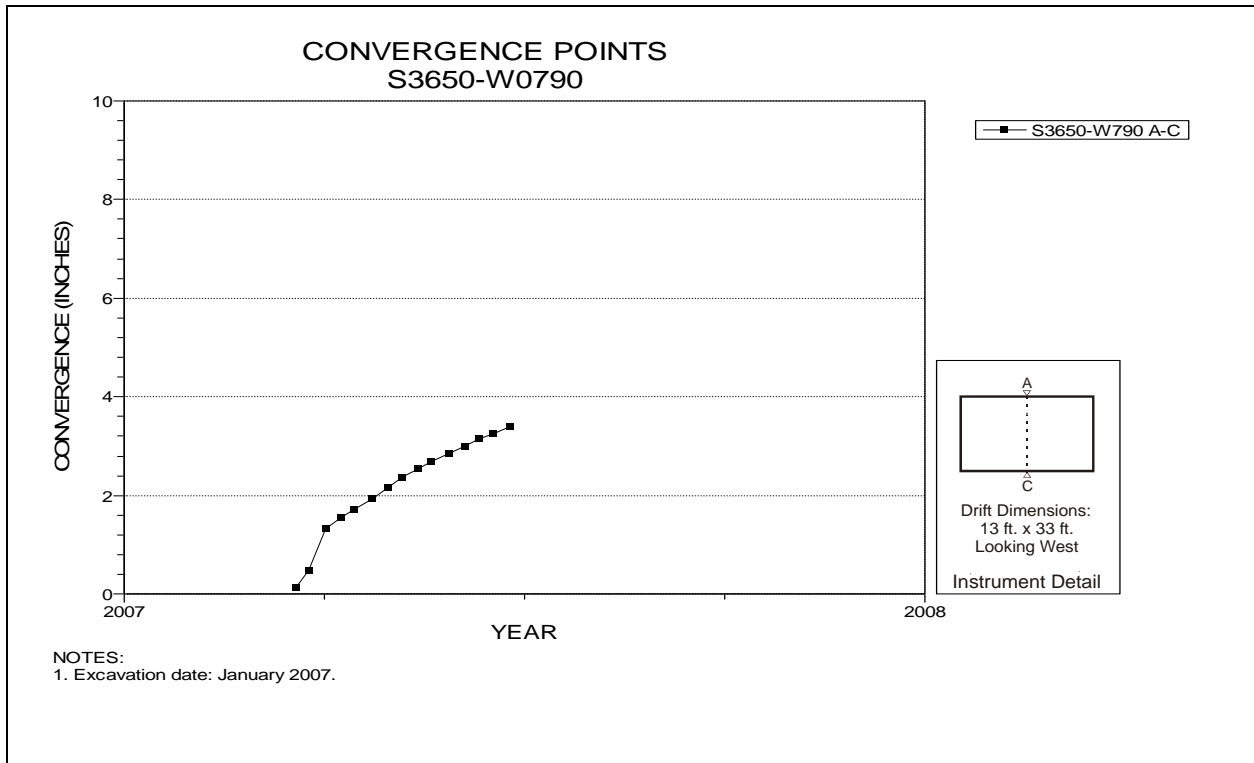


Figure 5-137 Convergence Point Array  
S3650 Drift at W790 Drift Intersection (Room 4, Panel 5) – Roof to Floor



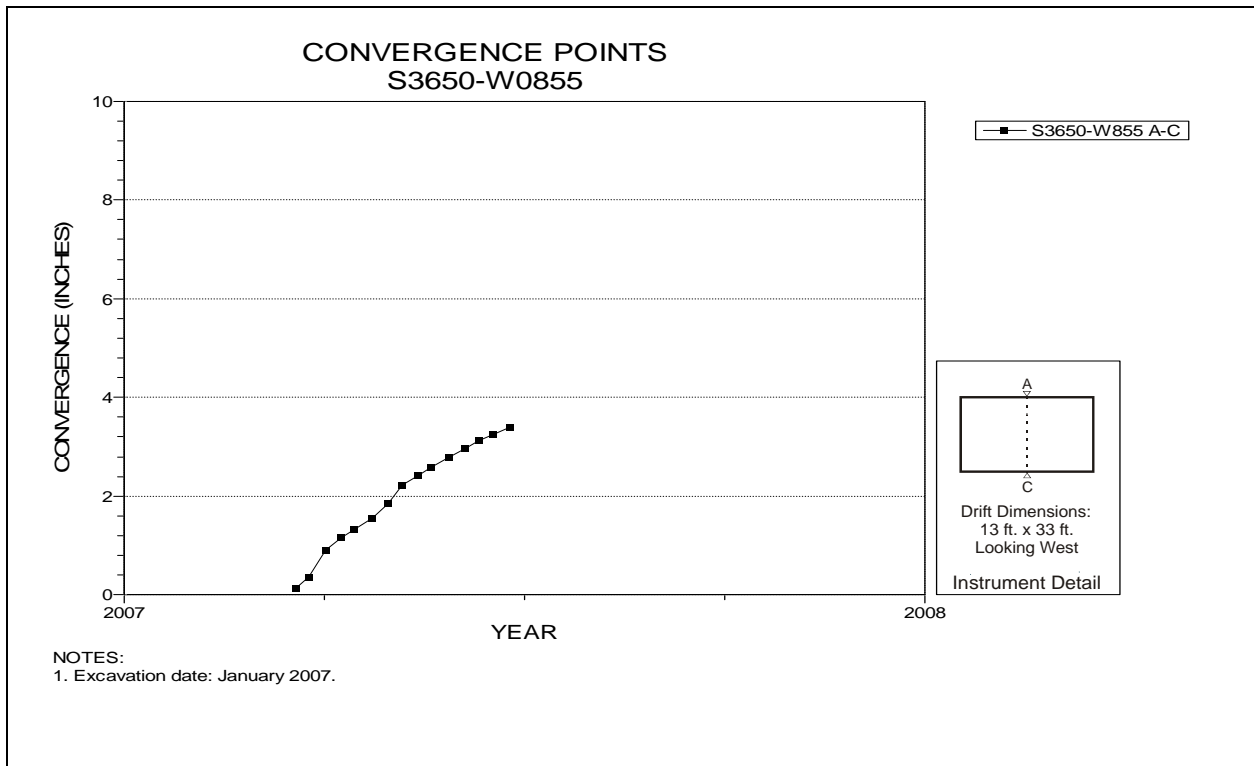


Figure 5-138 Convergence Point Array  
S3650 Drift at W855 – Roof to Floor

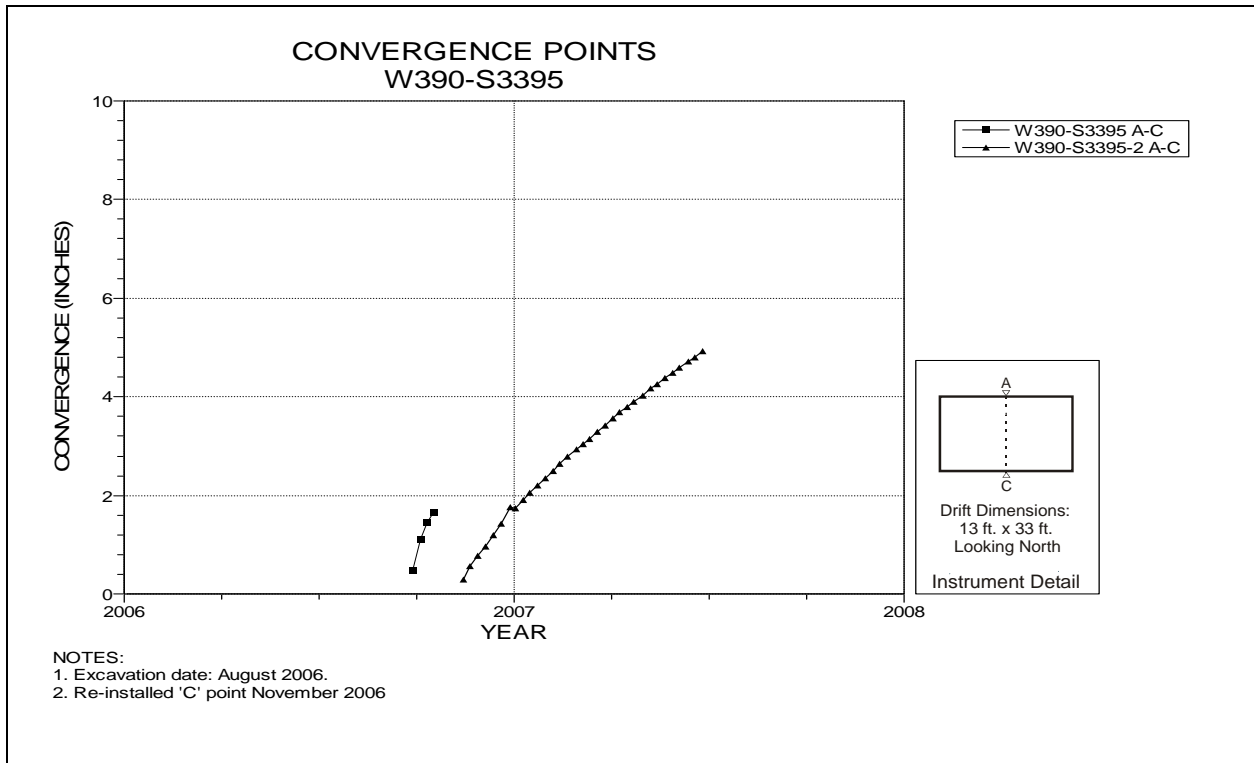


Figure 5-139 Convergence Point Array  
Room 1, Panel 5 at S3395 – Roof to Floor

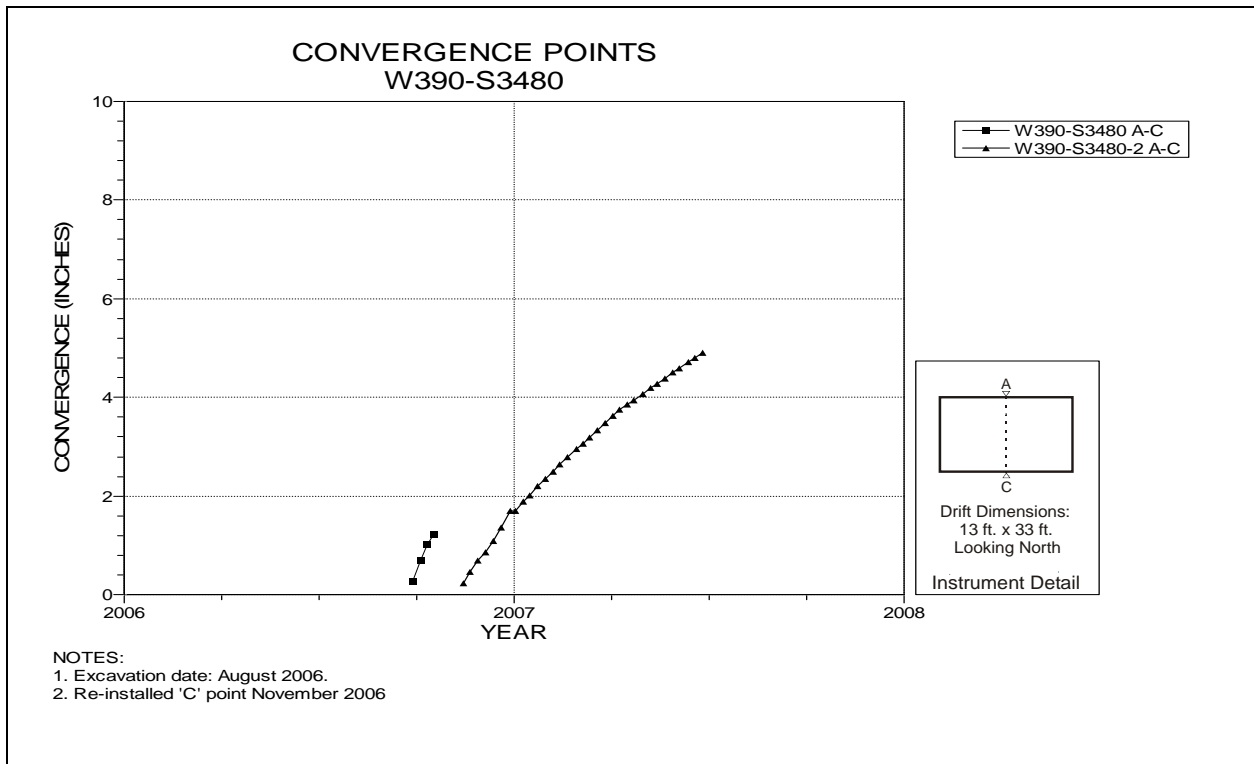


Figure 5-140 Convergence Point Array  
 Room 1, Panel 5 at S3480 – Room Center – Roof to Floor

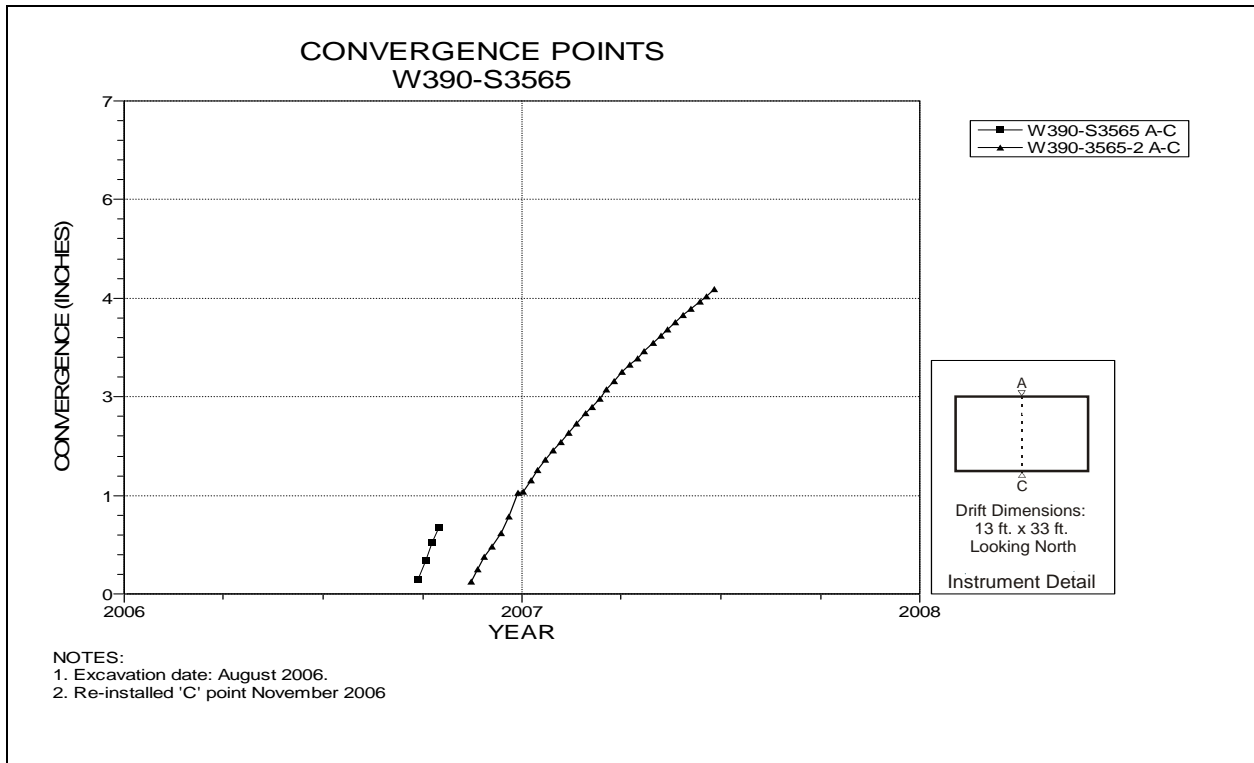


Figure 5-141 Convergence Point Array  
 Room 1, Panel 5 at S3565 – Room Center – Roof to Floor

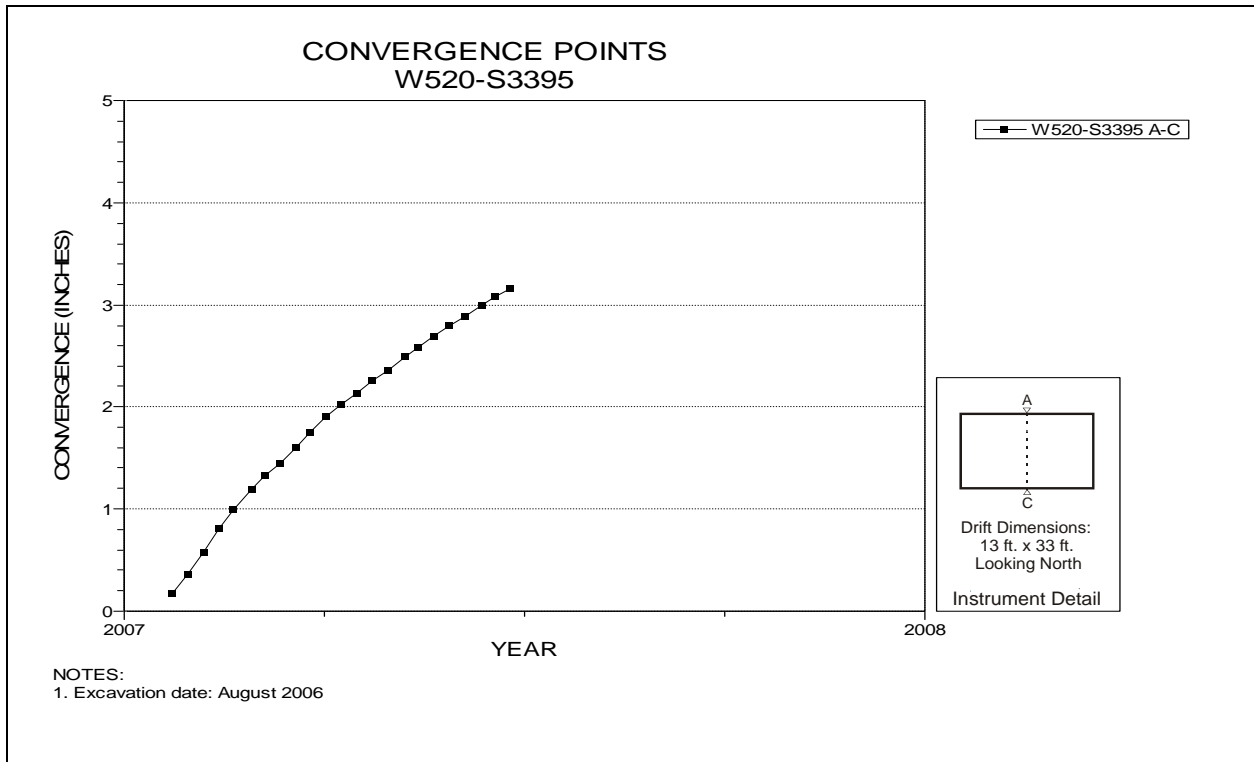


Figure 5-142 Convergence Point Array  
Room 2, Panel 5 at S3395 – Roof to Floor

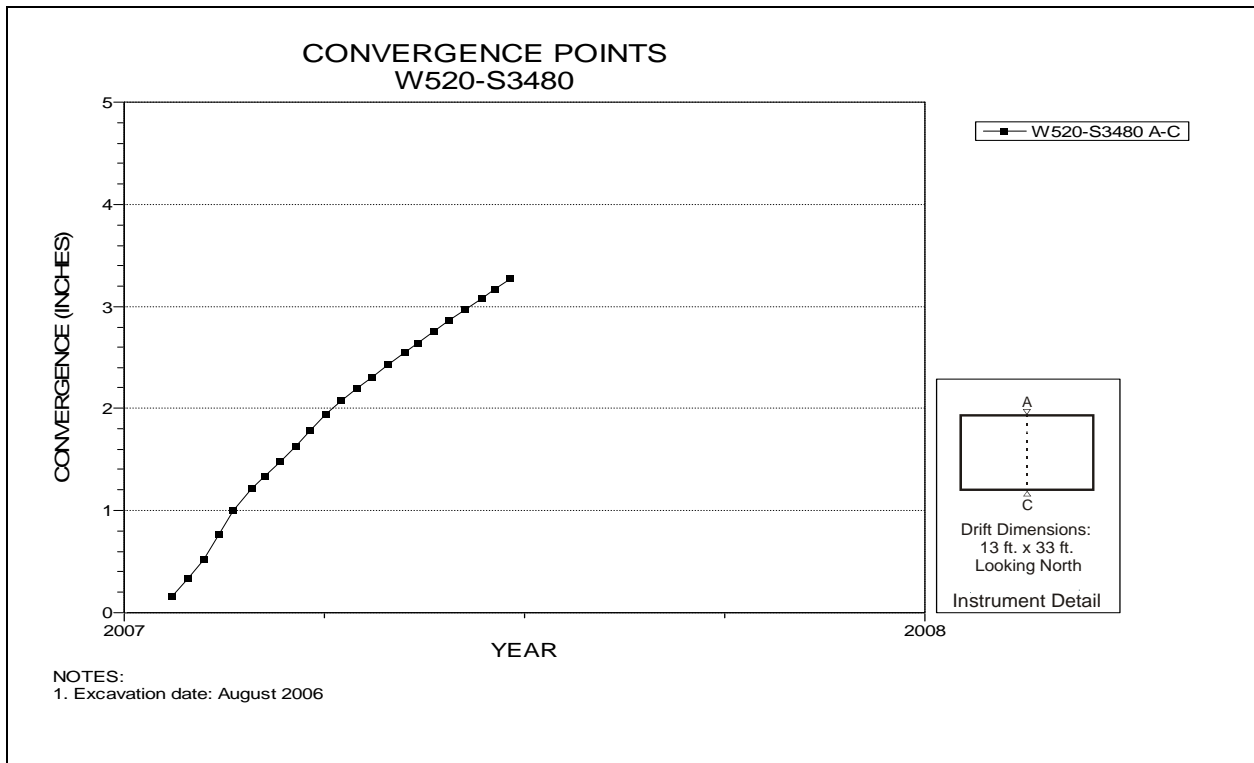


Figure 5-143 Convergence Point Array  
Room 2, Panel 5 at S3480 – Room Center – Roof to Floor

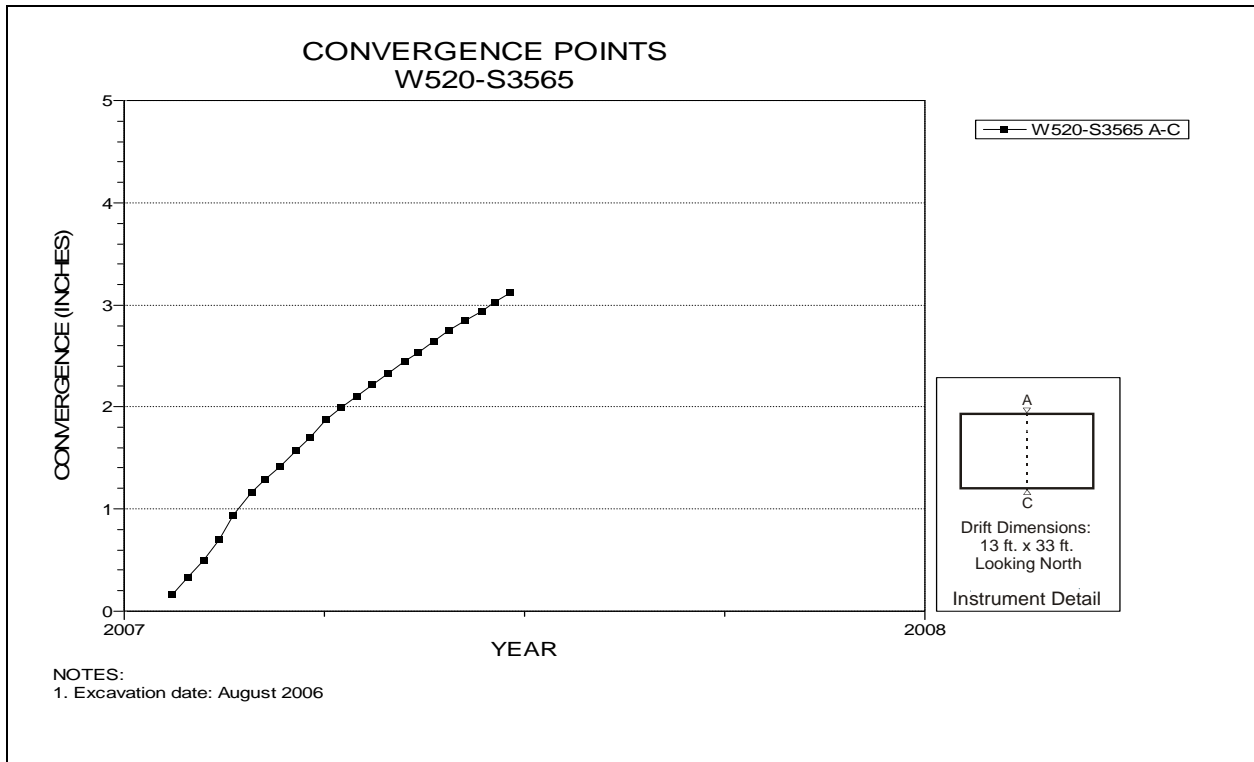


Figure 5-144 Convergence Point Array  
Room 2, Panel 5 at S3565 – Roof to Floor

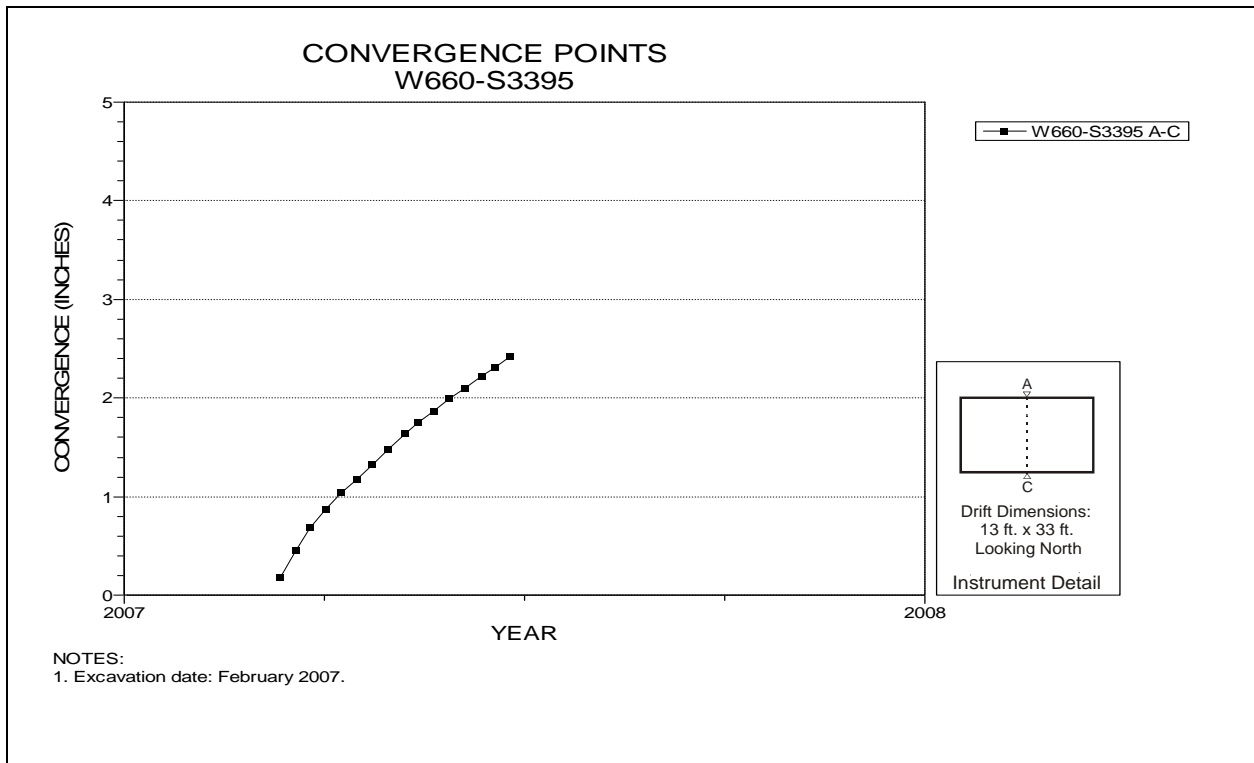


Figure 5-145 Convergence Point Array  
Room 3, Panel 5 at S3395 – Roof to Floor

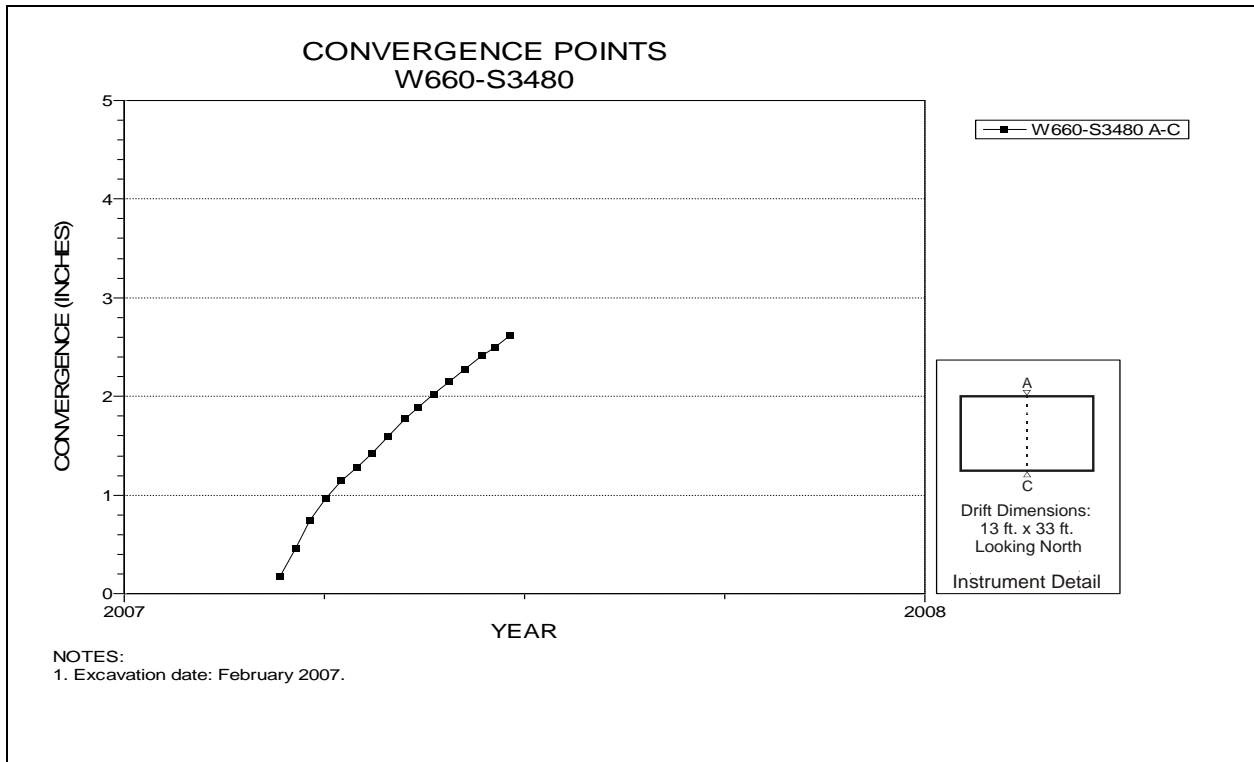


Figure 5-146 Convergence Point Array  
Room 3, Panel 5 at S3480 – Room Center – Roof to Floor

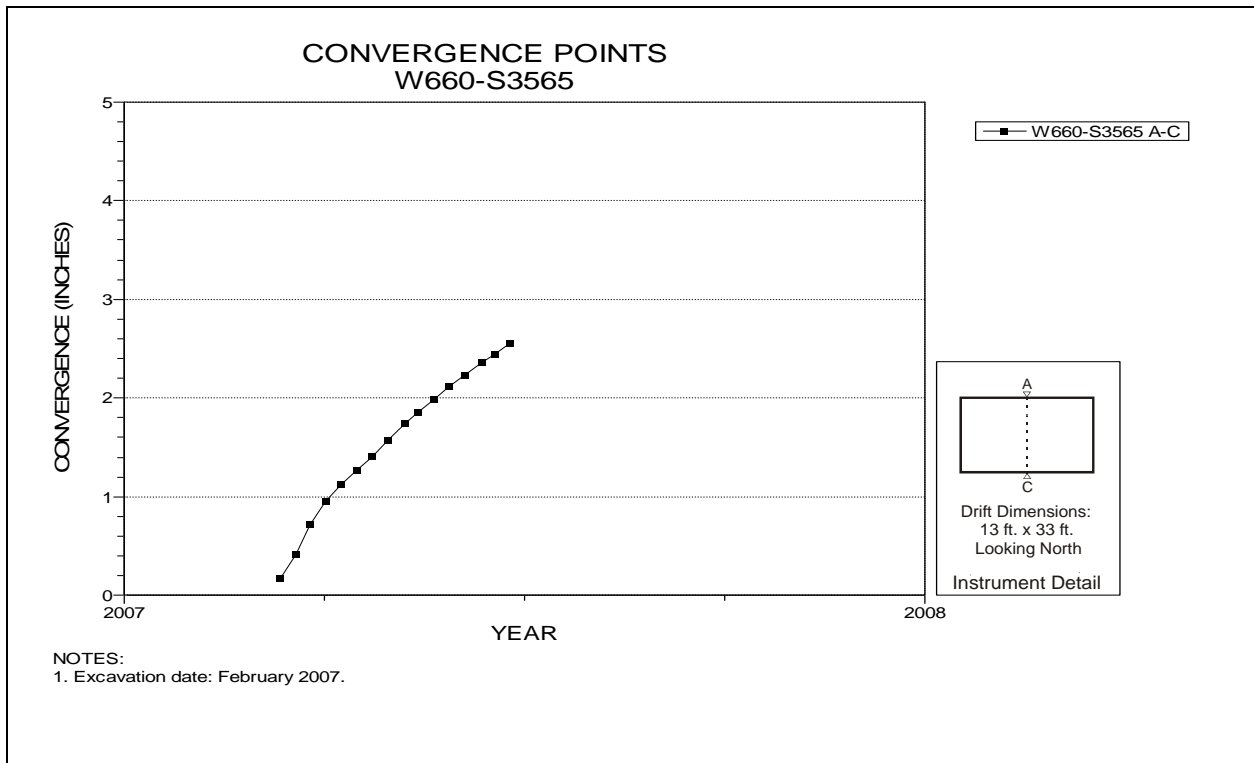


Figure 5-147 Convergence Point Array  
Room 3, Panel 5 at S3565 – Roof to Floor

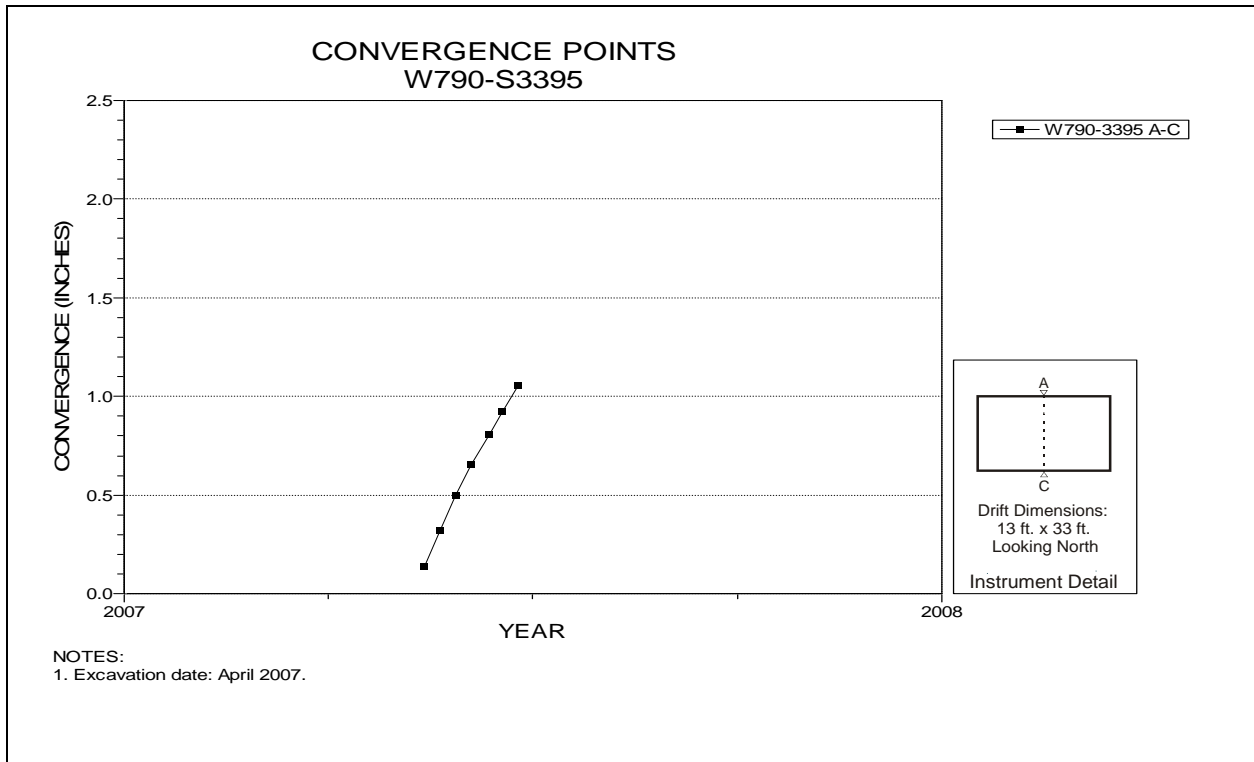


Figure 5-148 Convergence Point Array  
Room 4, Panel 5 at S3395 – Roof to Floor

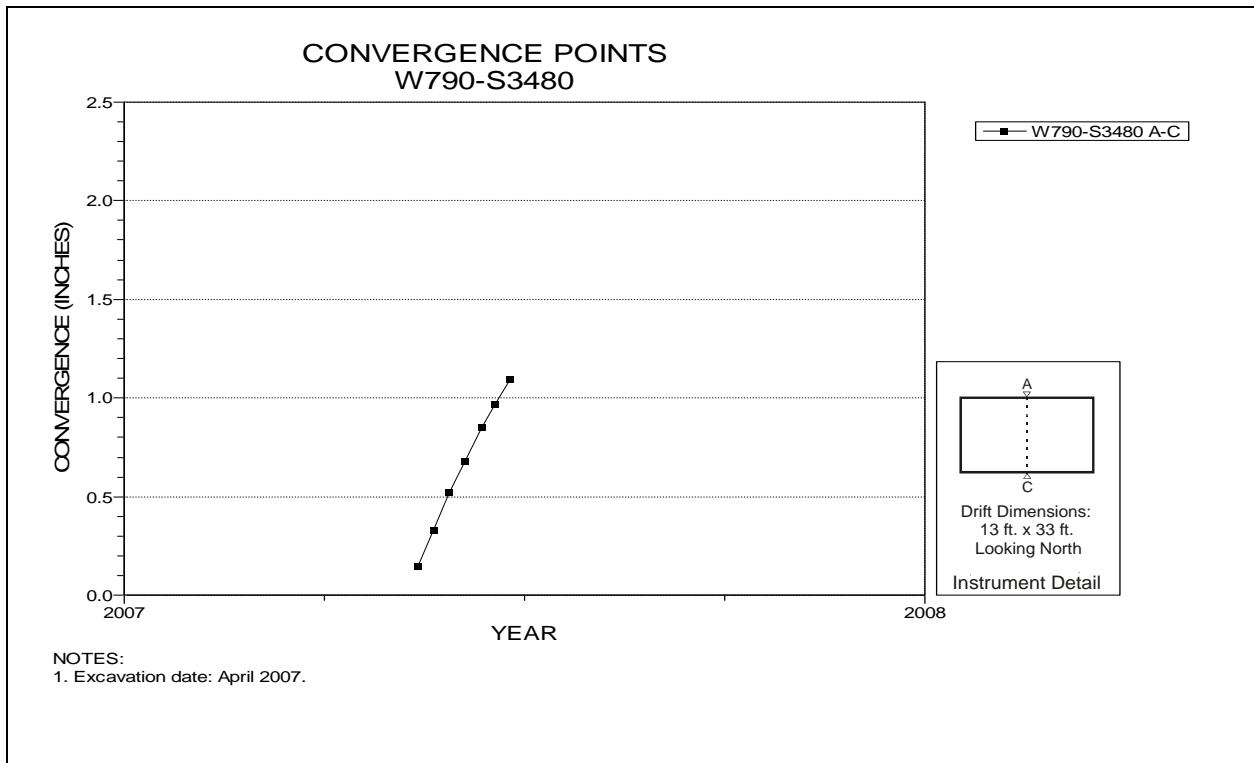


Figure 5-149 Convergence Point Array  
Room 4, Panel 5 at S3480 – Room Center – Roof to Floor

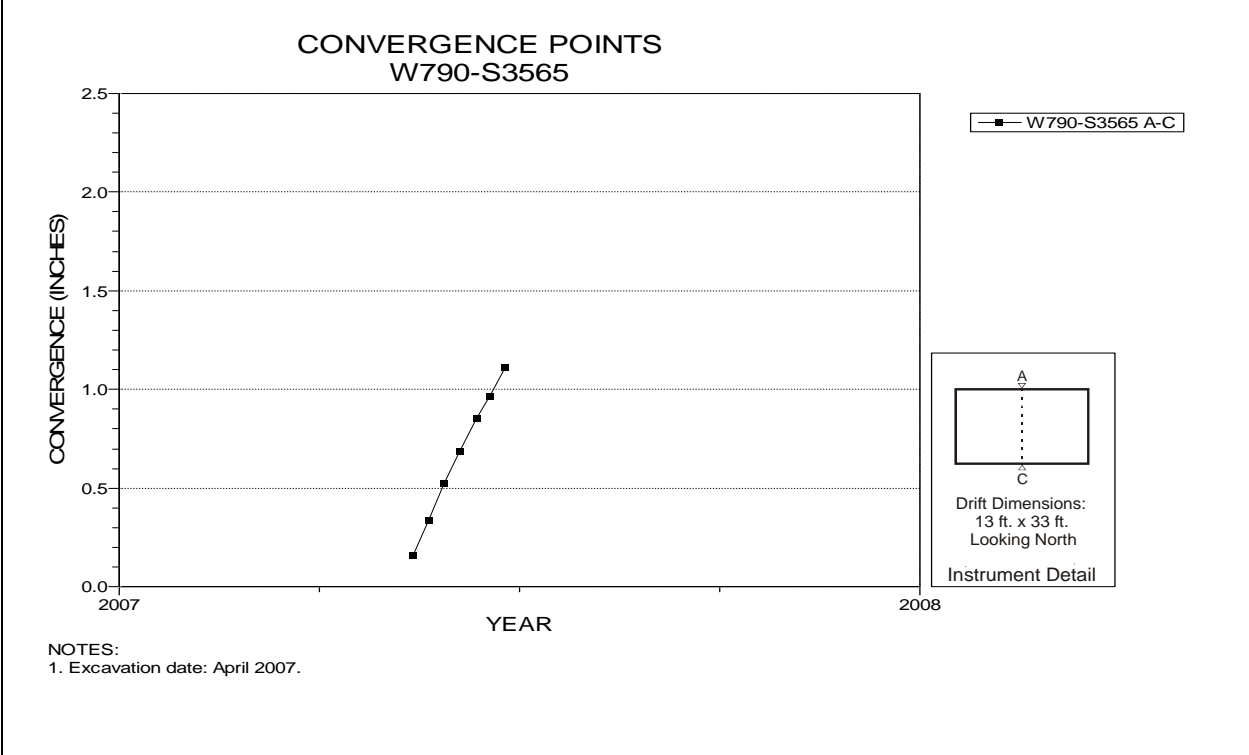


Figure 5-150 Convergence Point Array  
Room 4, Panel 5 at S3565 – Roof to Floor

## **6.0 Geoscience Program Supporting Data**

---

This chapter presents supporting data acquired as part of the Geoscience Program. It includes observations of clay seam displacements and other features in vertical observation holes, and fracture maps of excavation surfaces.

### **6.1 Borehole Inspections**

This section presents a summary of the clay seam displacements (offsets) and fracture densities measured in observation boreholes located through the WIPP underground facility. Relative lateral displacement of rock strata above and below a clay layer is measured as offset within a borehole. Fracture density is a calculated parameter based on the number of fractures (separations) and fracture zones observed in an observation borehole. Fracture density is calculated to be the number of fractures plus twice the number of fracture zones in a roof beam divided by the thickness of the beam (in feet). Table 6-1 presents the observed offset data for boreholes, the observed fractures and fracture zones, and the calculated fracture densities.

### **6.2 Fracture Mapping**

This section presents graphical results of the fracture mapping done in Panels 4 and 5 of the Waste Disposal Area. Figures 6-1 through 6-39 are plan view fracture maps for the roof in these panels.



**Table 6-1 (continued)**  
**Observation Borehole Fractures and Offset Data Summary**

Hole	Location	Initial Inspect. Date	Recent Inspect. Date	Fr <sup>1</sup>	FZ <sup>2</sup>	Beam Height (ft)	Feature	Fracture Density <sup>3</sup>	Feature Depth (ft)	Feature Magnitude (in)	Hole Dia. (in)	Hole Closure (%)	Offset Rate (in/yr)
<b>S1950, S1600</b>													
OH 391	S1951 - E456	07/22/03	06/18/07	1	0	6.0 <sup>4</sup>	Offset Separation Offset Separation	0.17	6.0 6.0 4.4 4.4	2.50 0.13 2.00 0.75	3.00	83 N/A 67 N/A	0.64 N/A 0.51 N/A
OH 392	S1953 - E448	07/22/03	06/18/07	1	0	6.0 <sup>4</sup>	Offset Separation	0.17	4.0 4.0	3.00 2.00	3.00	100 N/A	0.77 N/A
OH 393	S1614 - E451	07/22/03	06/18/07	0	0	6.0 <sup>4</sup>	No features	0.00	-	-	3.00	N/A	N/A
OH 394	S1613 - E434	07/22/03	06/18/07	0	0	6.0 <sup>4</sup>	No features	0.00	-	-	3.00	N/A	N/A
<b>East 300</b>													
OH 507	N1175 - E300	07/27/04	06/21/07	1	0	6.6	Clay H Separation	0.15	6.6 1.4	0.00 0.50	3.00	N/A N/A	N/A N/A
OH 508	N1250 - E300	07/27/04	06/21/07	0	0	6.4	Clay H	0.00	6.4	0.25	3.00	N/A	N/A
OH 509	N1350 - E300	07/27/04	06/21/07	0	0	5.5	Offset Clay H	0.00	5.5 5.5	0.06 0.13	3.00	2 N/A	0.02 N/A
OH 422	S2825 - E300	08/06/03	06/18/07	0	0	6.2	Clay H	0.00	6.2	0.13	3.00	N/A	N/A
OH 423	S2890 - E300	08/06/03	06/18/07	1	0	6.0	Clay H Separation	0.17	6.0 1.2	0.13 0.50	3.00	N/A N/A	N/A N/A

<sup>1</sup> Fr = Number of fractures in immediate roof beam  
<sup>2</sup> Number of fracture zones in immediate roof beam  
<sup>3</sup> Fracture Density = (Fr + 2 FZ) / Beam Height  
<sup>4</sup> Beam height estimated

**Table 6-1 (continued)**  
**Observation Borehole Fractures and Offset Data Summary**

Hole	Location	Initial Inspect. Date	Recent Inspect. Date	Fr <sup>1</sup>	FZ <sup>2</sup>	Beam Height (ft)	Feature	Fracture Density <sup>3</sup>	Feature Depth (ft)	Feature Magnitude (in)	Hole Dia. (in)	Hole Closure (%)	Offset Rate (in/yr)
<b>East 300 (continued)</b>													
OH 424	S2950 - E300	08/06/03	06/18/07	5	0	5.8	Offset Clay H Separation Separation Separation Separation Offset Separation	0.86	5.8 5.8 5.2 4.9 4.8 4.4 1.2 1.2	0.25 0.13 0.13 0.13 0.13 0.13 1.25 2.00	3.00	8 N/A N/A N/A N/A N/A 42 N/A	0.06 N/A N/A N/A N/A N/A 0.32 N/A
OH 425	S3020 - E300	08/06/03	06/18/07	2	0	6.0	Clay H Separation Separation	0.33	6.0 1.6 0.5	0.13 0.25 0.25	3.00	N/A N/A N/A	N/A N/A N/A
OH 459	S3140 - E300	08/28/03	06/18/07	0	0	5.8	Clay H	0.00	5.8	0.13	3.00	N/A	N/A
OH 458	S3200 - E300	08/28/03	06/18/07	0	0	5.8	Clay H	0.00	5.8	0.13	3.00	N/A	N/A
OH 457	S3260 - E300	08/28/03	06/18/07	1	0	6.0	Clay H Separation	0.17	6.0 1.3	0.13 0.13	3.00	N/A N/A	N/A N/A
OH 453	S3310 - E300	08/20/04	06/18/07	0	0	5.9	Separation Clay H	0.00	6.4 5.9	0.13 0.13	3.00	N/A N/A	N/A N/A
OH622	S3400 - E300	06/15/06	06/14/07	0	0	5.3	Clay H	0.00	5.3	0.13	3.00	N/A	N/A

<sup>1</sup> Fr = Number of fractures in immediate roof beam  
<sup>2</sup> Number of fracture zones in immediate roof beam  
<sup>3</sup> Fracture Density = (Fr + 2 FZ) / Beam Height

**Table 6-1 (continued)**  
**Observation Borehole Fractures and Offset Data Summary**

Hole	Location	Initial Inspect. Date	Recent Inspect. Date	Fr <sup>1</sup>	FZ <sup>2</sup>	Beam Height (ft)	Feature	Fracture Density <sup>3</sup>	Feature Depth (ft)	Feature Magnitude (in)	Hole Dia. (in)	Hole Closure (%)	Offset Rate (in/yr)
<b>East 300 (continued)</b>													
OH623	S3450 - E300	06/15/06	06/14/07	0	0	5.3	Offset Clay H	0.00	5.3	0.06 0.25	3.00	2 N/A	0.06 N/A
OH 604	S3480 - E300	07/18/05	06/14/07	1	0	5.4	Offset	0.19	5.6	0.25	3.00	8	0.13
							Separation		5.6	0.13		N/A	N/A
							Offset		5.4	0.13		4	0.07
							Clay H		5.4	0.13		N/A	N/A
							Offset		1.1	0.25		8	0.13
Separation	1.1	0.25	N/A	N/A									
OH624	S3550 - E300	06/15/06	06/14/07	1	0	5.8	Separation	0.17	6.1	0.13	3.00	N/A	N/A
							Clay H		5.8	0.13		N/A	N/A
							Separation		5.0	0.13		N/A	N/A
OH 569	S3650 - E300	04/20/05	06/04/07	0	0	5.8	Offset Clay H	0.00	5.8	0.25 0.06	3.00	8 N/A	0.12 N/A
<b>East 140</b>													
OH 521	N40 - E140	11/22/04	06/22/07	2	0	9.0 <sup>4</sup>	Separation	0.22	9.0	0.50	3.00	N/A	N/A
							Separation		8.2	0.25		N/A	N/A
							Separation		7.6	0.25		N/A	N/A
OH 524	S182 - E140	11/22/04	03/22/07	2	0	9.5 <sup>4</sup>	Separation	0.21	9.5	0.13	3.00	N/A	N/A
							Separation		8.5	0.13		N/A	N/A
							Separation		5.3	0.13		N/A	N/A

<sup>1</sup> Fr = Number of fractures in immediate roof beam  
<sup>2</sup> Number of fracture zones in immediate roof beam  
<sup>3</sup> Fracture Density = (Fr + 2 FZ) / Beam Height  
<sup>4</sup> Beam height estimated

**Table 6-1 (continued)**  
**Observation Borehole Fractures and Offset Data Summary**

Hole	Location	Initial Inspect. Date	Recent Inspect. Date	Fr <sup>1</sup>	FZ <sup>2</sup>	Beam Height (ft)	Feature	Fracture Density <sup>3</sup>	Feature Depth (ft)	Feature Magnitude (in)	Hole Dia. (in)	Hole Closure (%)	Offset Rate (in/yr)
<b>East 140 (continued)</b>													
OH 498	S415 - E140	02/17/04	06/22/07	2	0	6.0 <sup>4</sup>	Offset Separation Offset Separation	0.33	3.4 3.4 3.0 3.0	0.38 1.00 2.00 0.50	3.00	13 N/A 67 N/A	0.11 N/A 0.60 N/A
OH 620	S700 - E140		06/11/07	0	0	5.7	Clay H	0.00	5.7	0.25	3.00	N/A	N/A
OH 575	S1000 - E140	06/13/05	06/11/07				Separation Offset Separation		4.7 3.5 3.5	0.50 1.00 0.13	3.00	N/A 33 N/A	N/A 0.50 N/A
OH 577	S1160 - E140	06/16/05	06/11/07	1	0	5.5	Separation Clay H Separation	0.18	6.5 5.5 2.6	0.50 0.75 0.50	3.00	N/A N/A N/A	N/A N/A N/A
OH 578	S1300 - E140	06/16/05	06/11/07	0	0	6.5	Clay H	0.00	6.5	0.13	3.00	N/A	N/A
OH 579	S1463 - E140	06/16/05	06/11/07	4	0	6.4	Separation Offset Clay H Offset Separation Offset Separation Offset Separation Offset Separation	0.63	6.5 6.4 6.4 2.5 2.5 1.9 1.9 1.4 1.4 0.6 0.6	0.13 1.25 0.13 0.13 1.25 0.50 0.75 0.75 0.25 0.50 0.25	3.00	N/A 42 N/A 4 N/A 17 N/A 25 N/A 17 N/A	N/A 0.63 N/A 0.06 N/A 0.25 N/A 0.38 N/A 0.25 N/A

<sup>1</sup> Fr = Number of fractures in immediate roof beam  
<sup>2</sup> Number of fracture zones in immediate roof beam  
<sup>3</sup> Fracture Density = (Fr + 2 FZ) / Beam Height  
<sup>4</sup> Beam height estimated

**Table 6-1 (continued)**  
**Observation Borehole Fractures and Offset Data Summary**

Hole	Location	Initial Inspect. Date	Recent Inspect. Date	Fr <sup>1</sup>	FZ <sup>2</sup>	Beam Height (ft)	Feature	Fracture Density <sup>3</sup>	Feature Depth (ft)	Feature Magnitude (in)	Hole Dia. (in)	Hole Closure (%)	Offset Rate (in/yr)
<b>East 140 (continued)</b>													
OH 580	S1463 - E140	06/16/05	06/11/07	7	0	5.8	Offset	1.21	6.1	0.38	3.00	13	0.19
							Separation		6.1	0.13		N/A	N/A
							Offset		5.8	0.38		13	0.19
							Clay H		5.8	1.00		N/A	N/A
							Offset		4.6	0.25		8	0.13
							Separation		4.6	4.00		N/A	N/A
							Separation		4.3	0.13		N/A	N/A
							Separation		4.1	0.13		N/A	N/A
							Offset		2.4	0.38		13	0.19
							Separation		2.4	2.00		N/A	N/A
							Separation		1.6	0.13		N/A	N/A
							Offset		1.0	0.25		8	0.13
							Separation		1.0	0.25		N/A	N/A
							Offset		0.9	0.13		4	0.06
Separation	0.9	0.13	N/A	N/A									
OH 581	S1463 - E140	06/16/05	06/11/07	2	0	6.5	Offset	0.31	6.5	1.00	3.00	33	0.50
							Clay H		6.5	0.13		N/A	N/A
							Offset		1.6	0.13		4	0.06
							Separation		1.6	0.13		N/A	N/A
							Offset		1.1	0.50		17	0.25
							Separation		1.1	1.25		N/A	N/A
OH 582	S1600 - E140	06/16/05	06/11/07	0	0	6.0	Clay H	0.00	6.0	0.00	3.00	N/A	N/A

<sup>1</sup> Fr = Number of fractures in immediate roof beam  
<sup>2</sup> Number of fracture zones in immediate roof beam  
<sup>3</sup> Fracture Density = (Fr + 2 FZ) / Beam Height

**Table 6-1 (continued)**  
**Observation Borehole Fractures and Offset Data Summary**

Hole	Location	Initial Inspect. Date	Recent Inspect. Date	Fr <sup>1</sup>	FZ <sup>2</sup>	Beam Height (ft)	Feature	Fracture Density <sup>3</sup>	Feature Depth (ft)	Feature Magnitude (in)	Hole Dia. (in)	Hole Closure (%)	Offset Rate (in/yr)
<b>East 140 (continued)</b>													
OH 511	S1775 - E140	08/04/04	03/19/07	4	0	5.6	Offset	0.71	5.6	3.00	3.00	100	1.14
							Clay H		5.6	0.25		N/A	N/A
							Separation		4.6	0.75		N/A	N/A
							Offset		3.6	0.38		13	0.14
							Separation		3.6	2.00		N/A	N/A
							Separation		2.4	0.38		N/A	N/A
							Separation		0.6	1.00		N/A	N/A
OH 142-2	S1780 - E140	06/29/05	06/11/07	5	0	6.7	Offset	0.75	6.7	2.00	3.00	67	0.02
							Clay H		6.7	2.00		N/A	N/A
							Separation		5.8	0.13		N/A	N/A
							Separation		3.2	1.25		N/A	N/A
							Offset		2.7	0.38		13	0.19
							Separation		2.7	2.00		N/A	N/A
							Offset		1.6	0.75		25	0.38
							Separation		1.6	1.25		N/A	N/A
							Offset		1.0	1.00		33	0.51
							Separation		1.0	0.50		N/A	N/A

<sup>1</sup> Fr = Number of fractures in immediate roof beam  
<sup>2</sup> Number of fracture zones in immediate roof beam  
<sup>3</sup> Fracture Density = (Fr + 2 FZ) / Beam Height

**Table 6-1 (continued)**  
**Observation Borehole Fractures and Offset Data Summary**

Hole	Location	Initial Inspect. Date	Recent Inspect. Date	Fr <sup>1</sup>	FZ <sup>2</sup>	Beam Height (ft)	Feature	Fracture Density <sup>3</sup>	Feature Depth (ft)	Feature Magnitude (in)	Hole Dia. (in)	Hole Closure (%)	Offset Rate (in/yr)
<b>East 140 (continued)</b>													
OH 143-2	S1780 - E140	06/29/05	06/11/07	7	0	6.0	Offset	1.17	6.0	2.25	3.00	75	1.15
							Clay H		6.0	0.75		N/A	N/A
							Separation		5.8	0.13		N/A	N/A
							Separation		5.2	0.13		N/A	N/A
							Separation		5.0	0.13		N/A	N/A
							Separation		4.0	1.00		N/A	N/A
							Offset		2.5	0.38		13	0.19
							Separation		2.5	4.25		N/A	N/A
							Offset		1.5	0.75		25	0.38
							Separation		1.5	0.38		N/A	N/A
							Offset		1.0	0.06		2	0.03
							Separation		1.0	0.13		N/A	N/A
							OH 144-2		S1780 - E140	06/29/05		06/11/07	7
Offset	7.1	2.00	67	1.03									
Separation	7.1	2.00	N/A	N/A									
Offset	6.6	1.00	33	0.51									
Clay H	6.6	1.50	N/A	N/A									
Separation	6.5	0.25	N/A	N/A									
Separation	6.1	0.13	N/A	N/A									
Separation	4.2	2.00	N/A	N/A									
Separation	3.5	0.25	N/A	N/A									
Offset	2.8	0.50	17	0.26									
Separation	2.8	1.50	N/A	N/A									
Offset	1.8	0.50	17	0.26									
Separation	1.8	0.75	N/A	N/A									
Offset	1.3	0.50	17	0.26									
Separation	1.3	0.50	N/A	N/A									

<sup>1</sup> Fr = Number of fractures in immediate roof beam  
<sup>2</sup> Number of fracture zones in immediate roof beam  
<sup>3</sup> Fracture Density = (Fr + 2 FZ) / Beam Height

**Table 6-1 (continued)**  
**Observation Borehole Fractures and Offset Data Summary**

Hole	Location	Initial Inspect. Date	Recent Inspect. Date	Fr <sup>1</sup>	FZ <sup>2</sup>	Beam Height (ft)	Feature	Fracture Density <sup>3</sup>	Feature Depth (ft)	Feature Magnitude (in)	Hole Dia. (in)	Hole Closure (%)	Offset Rate (in/yr)
<b>East 140 (continued)</b>													
OH 145-2	S1832 - E140	03/15/06	03/19/07	6	0	6.5	Offset	0.92	6.5	2.00	3.00	67	1.98
							Clay H		6.5	1.00		N/A	N/A
							Separation		4.0	0.13		N/A	N/A
							Offset		3.7	0.13		4	0.12
							Separation		3.7	0.13		N/A	N/A
							Offset		3.0	0.38		13	0.37
							Separation		3.0	1.75		N/A	N/A
							Offset		2.5	0.38		13	0.37
							Separation		2.5	2.00		N/A	N/A
							Offset		1.5	0.13		4	0.12
							Separation		1.5	0.75		N/A	N/A
							Offset		0.8	0.75		25	0.74
							Separation		0.8	2.00		N/A	N/A
OH 146-2	S1832 - E140	06/15/04	06/11/07	7	0	6.3	Separation	1.11	8.2	0.25	3.00	N/A	N/A
							Separation		7.5	0.13		N/A	N/A
							Separation		7.2	0.13		N/A	N/A
							Separation		6.8	0.13		N/A	N/A
							Separation		6.5	0.13		N/A	N/A
							Clay H		6.3	0.25		N/A	N/A
							Separation		6.0	0.13		N/A	N/A
							Separation		5.7	0.25		N/A	N/A
							Offset		4.5	1.50		50	0.50
							Separation		4.5	7.00		N/A	N/A
							Offset		3.7	0.25		8	0.08
							Separation		3.7	1.00		N/A	N/A
							Offset		2.3	0.38		13	0.13
							Separation		2.3	2.00		N/A	N/A
							Offset		1.4	0.50		17	0.17
							Separation		1.4	0.38		N/A	N/A
							Offset		0.8	0.13		4	0.04
Separation	0.8	0.25	N/A	N/A									

<sup>1</sup> Fr = Number of fractures in immediate roof beam  
<sup>2</sup> Number of fracture zones in immediate roof beam  
<sup>3</sup> Fracture Density = (Fr + 2 FZ) / Beam Height



**Table 6-1 (continued)**  
**Observation Borehole Fractures and Offset Data Summary**

Hole	Location	Initial Inspect. Date	Recent Inspect. Date	Fr <sup>1</sup>	FZ <sup>2</sup>	Beam Height (ft)	Feature	Fracture Density <sup>3</sup>	Feature Depth (ft)	Feature Magnitude (in)	Hole Dia. (in)	Hole Closure (%)	Offset Rate (in/yr)
<b>East 140 (continued)</b>													
OH 147-2	S1832 - E140	06/15/04	06/11/07	4	0	6.9	Offset	0.58	6.9	2.00	3.00	67	0.67
							Clay H		6.9	0.13		N/A	N/A
							Separation		3.7	0.75		N/A	N/A
							Offset		3.1	0.75		25	0.25
							Separation		3.1	1.75		N/A	N/A
							Offset		2.5	1.00		33	0.33
							Separation		2.5	2.50		N/A	N/A
							Offset		1.4	1.50		50	0.50
Separation	1.4	1.00	N/A	N/A									
OH 583	S1950 - E140	06/16/05	06/11/07	1	0	6.0	Separation	0.17	6.6	0.13	3.00	N/A	N/A
							Offset		6.0	0.06		2	0.02
							Clay H		6.0	0.50		N/A	N/A
							Offset		1.0	0.06		2	0.03
							Separation		1.0	0.25		N/A	N/A
OH 474	S1999 - E140	01/21/05	06/11/07	2	0	5.6	Separation	0.36	7.1	0.13	3.00	N/A	N/A
							Separation		6.4	0.13		N/A	N/A
							Separation		6.0	0.13		N/A	N/A
							Offset		5.6	0.13		4	0.05
							Clay H		5.6	0.38		N/A	N/A
							Separation		5.4	0.13		N/A	N/A
							Offset		1.4	0.13		4	0.05
							Separation		1.4	0.13		N/A	N/A
OH 512	S2010 - E140	08/04/04	06/11/07	2	0	6.0	Separation	0.33	6.3	0.13	3.00	N/A	N/A
							Clay H		6.0	0.25		N/A	N/A
							Separation		5.2	0.13		N/A	N/A
							Offset		1.4	0.13		4	0.04
							Separation		1.4	1.00		N/A	N/A

<sup>1</sup> Fr = Number of fractures in immediate roof beam  
<sup>2</sup> Number of fracture zones in immediate roof beam  
<sup>3</sup> Fracture Density = (Fr + 2 FZ) / Beam Height

**Table 6-1 (continued)**  
**Observation Borehole Fractures and Offset Data Summary**

Hole	Location	Initial Inspect. Date	Recent Inspect. Date	Fr <sup>1</sup>	FZ <sup>2</sup>	Beam Height (ft)	Feature	Fracture Density <sup>3</sup>	Feature Depth (ft)	Feature Magnitude (in)	Hole Dia. (in)	Hole Closure (%)	Offset Rate (in/yr)
<b>East 140 (continued)</b>													
OH 473	S2092 - E140	01/21/05	06/11/07	4	0	5.4	Offset	0.74	6.0	1.00	3.00	33	0.42
							Separation		6.0	0.25		N/A	N/A
							Separation		5.6	0.13		N/A	N/A
							Separation		5.5	0.13		N/A	N/A
							Offset		5.4	1.00		33	0.42
							Clay H		5.4	0.75		N/A	N/A
							Separation		4.9	0.13		N/A	N/A
							Separation		4.0	0.13		N/A	N/A
							Separation		2.5	0.25		N/A	N/A
							Offset		1.2	0.13		4	0.05
Separation	1.2	0.13	N/A	N/A									
OH 472	S2167 - E140	01/21/05	06/11/07	0	0	5.9	Offset	0.00	5.9	0.38	3.00	13	0.16
							Clay H		5.9	0.13		N/A	N/A
OH 584	S2180 - E140	06/16/05	06/11/07	0	0	5.6	Clay H	0.00	5.6	0.13	3.00	N/A	N/A
OH 471	S2333 - E140	01/21/05	06/11/07	5	0	5.4	Separation	0.93	6.5	3.00	3.00	N/A	N/A
							Separation		5.6	0.13		N/A	N/A
							Offset		5.4	2.75		92	1.15
							Clay H		5.4	1.00		N/A	N/A
							Separation		5.3	0.13		N/A	N/A
							Separation		3.6	0.38		N/A	N/A
							Offset		2.4	1.00		33	0.42
							Separation		2.4	2.00		N/A	N/A
							Offset		1.4	0.75		25	0.31
							Separation		1.4	0.75		N/A	N/A

<sup>1</sup> Fr = Number of fractures in immediate roof beam  
<sup>2</sup> Number of fracture zones in immediate roof beam  
<sup>3</sup> Fracture Density = (Fr + 2 FZ) / Beam Height

**Table 6-1 (continued)**  
**Observation Borehole Fractures and Offset Data Summary**

Hole	Location	Initial Inspect. Date	Recent Inspect. Date	Fr <sup>1</sup>	FZ <sup>2</sup>	Beam Height (ft)	Feature	Fracture Density <sup>3</sup>	Feature Depth (ft)	Feature Magnitude (in)	Hole Dia. (in)	Hole Closure (%)	Offset Rate (in/yr)
<b>East 140 (continued)</b>													
OH 513	S2351 - E140	08/11/04	03/19/07	3	0	5.0	Offset	0.60	5.0	2.25	3.00	75	0.86
							Clay H		5.0	0.13		N/A	N/A
							Offset		2.5	0.25		8	0.10
							Separation		2.5	3.00		N/A	N/A
							Offset		1.3	0.25		8	0.10
							Separation		1.3	1.00		N/A	N/A
							Separation		0.8	0.13		N/A	N/A
OH 585	S2358 - E140	06/16/05	06/28/07	4	0	6.1	Separation	0.66	7.0	0.13	3.00	N/A	N/A
							Offset		6.6	3.00		100	1.48
							Separation		6.6	1.00		N/A	N/A
							Clay H		6.1	0.50		N/A	N/A
							Separation		4.0	0.25		N/A	N/A
							Offset		2.9	2.25		75	1.11
							Separation		2.9	0.38		N/A	N/A
							Offset		1.9	2.00		67	0.98
							Separation		1.9	0.38		N/A	N/A
							Offset		1.4	1.25		42	0.61
							Separation		1.4	0.13		N/A	N/A

<sup>1</sup> Fr = Number of fractures in immediate roof beam

<sup>2</sup> Number of fracture zones in immediate roof beam

<sup>3</sup> Fracture Density = (Fr + 2 FZ) / Beam Height

**Table 6-1 (continued)**  
**Observation Borehole Fractures and Offset Data Summary**

Hole	Location	Initial Inspect. Date	Recent Inspect. Date	Fr <sup>1</sup>	FZ <sup>2</sup>	Beam Height (ft)	Feature	Fracture Density <sup>3</sup>	Feature Depth (ft)	Feature Magnitude (in)	Hole Dia. (in)	Hole Closure (%)	Offset Rate (in/yr)
<b>East 140 (continued)</b>													
OH 586	S2358 - E140	06/16/05	06/11/07	6	0	6.4	Offset	0.94	6.4	1.00	3.00	33	0.50
							Clay H		6.4	1.00		N/A	N/A
							Offset		5.7	0.38		13	0.19
							Separation		5.7	0.13		N/A	N/A
							Separation		5.6	0.13		N/A	N/A
							Offset		5.4	0.38		13	0.19
							Separation		5.4	0.13		N/A	N/A
							Offset		5.2	1.00		33	0.50
							Separation		5.2	0.13		N/A	N/A
							Offset		2.4	0.25		8	0.13
							Separation		2.4	3.00		N/A	N/A
							Offset		1.4	0.38		13	0.19
							Separation		1.4	0.75		N/A	N/A
OH 587	S2358 - E140	06/16/05	06/11/07	3	0	6.1	Separation	0.49	6.9	0.13	3.00	N/A	N/A
							Offset		6.1	3.00		100	1.51
							Clay H		6.1	0.13		N/A	N/A
							Offset		4.0	3.00		100	1.51
							Separation		4.0	0.13		N/A	N/A
							Offset		2.6	2.00		67	1.01
							Separation		2.6	1.25		N/A	N/A
							Offset		1.6	1.00		33	0.50
							Separation		1.6	0.75		N/A	N/A
OH 588	S2520 - E140	06/16/05	06/11/07	1	0	5.3	Separation	0.19	5.9	0.13	3.00	N/A	N/A
							Offset		5.3	0.25		8	0.13
							Clay H		5.3	1.00		N/A	N/A
							Separation		1.6	0.25		N/A	N/A

<sup>1</sup> Fr = Number of fractures in immediate roof beam  
<sup>2</sup> Number of fracture zones in immediate roof beam  
<sup>3</sup> Fracture Density = (Fr + 2 FZ) / Beam Height

**Table 6-1 (continued)**  
**Observation Borehole Fractures and Offset Data Summary**

Hole	Location	Initial Inspect. Date	Recent Inspect. Date	Fr <sup>1</sup>	FZ <sup>2</sup>	Beam Height (ft)	Feature	Fracture Density <sup>3</sup>	Feature Depth (ft)	Feature Magnitude (in)	Hole Dia. (in)	Hole Closure (%)	Offset Rate (in/yr)
<b>East 140 (continued)</b>													
OH 468	S2640 - E140	03/29/04	06/11/07				Offset		2.0	3.00	3.00	100	0.94
							Separation		2.0	0.25		N/A	N/A
							Offset		1.0	2.75		92	0.86
							Separation		1.0	4.00		N/A	N/A
OH 589	S2750 - E140	06/16/05	06/04/07	0	0	6.0	Separation	0.00	6.5	0.13	3.00	N/A	N/A
							Separation		6.3	0.13		N/A	N/A
							Clay H		6.0	0.13		N/A	N/A
OH 500	S2920 - E140	02/20/04	06/04/07	4	0	5.5	Offset	0.73	7.8	0.13	3.00	4	0.04
							Separation		6.5	0.25		N/A	N/A
							Separation		6.0	2.00		N/A	N/A
							Offset		5.5	2.00		67	0.61
							Clay H		5.5	0.75		N/A	N/A
							Separation		5.2	0.13		N/A	N/A
							Separation		4.8	0.13		N/A	N/A
							Offset		2.0	1.50		50	0.46
							Separation		2.0	2.00		N/A	N/A
							Offset		1.1	1.50		50	0.46
Separation	1.1	1.00	N/A	N/A									

<sup>1</sup> Fr = Number of fractures in immediate roof beam  
<sup>2</sup> Number of fracture zones in immediate roof beam  
<sup>3</sup> Fracture Density = (Fr + 2 FZ) / Beam Height

**Table 6-1 (continued)**  
**Observation Borehole Fractures and Offset Data Summary**

Hole	Location	Initial Inspect. Date	Recent Inspect. Date	Fr <sup>1</sup>	FZ <sup>2</sup>	Beam Height (ft)	Feature	Fracture Density <sup>3</sup>	Feature Depth (ft)	Feature Magnitude (in)	Hole Dia. (in)	Hole Closure (%)	Offset Rate (in/yr)
<b>East 140 (continued)</b>													
OH 501	S2986 - E140	02/20/04	06/04/07	2	0	5.4	Separation	0.37	8.0	1.50	3.00	N/A	N/A
							Separation		7.2	0.38		N/A	N/A
							Separation		6.8	0.13		N/A	N/A
							Separation		6.6	0.25		N/A	N/A
							Offset		5.4	1.50		50	0.46
							Clay H		5.4	4.50		N/A	N/A
							Offset		1.8	1.50		50	0.46
							Separation		1.8	5.00		N/A	N/A
							Offset		0.9	1.50		50	0.46
Separation	0.9	1.50	N/A	N/A									
OH 590	S3080 - E140	06/16/05	06/04/07	2	0	5.7	Offset	0.35	5.7	0.13	3.00	4	0.06
							Clay H		5.7	1.50		N/A	N/A
							Offset		1.3	0.13		4	0.06
							Separation		1.3	0.25		N/A	N/A
							Offset		0.4	0.13		4	0.06
							Separation		0.4	0.13		N/A	N/A
OH 493	S3180 - E140	01/13/04	06/04/07	2	0	5.5	Separation	0.36	7.0	0.13	3.00	N/A	N/A
							Separation		6.1	0.13		N/A	N/A
							Offset		5.5	0.38		13	0.11
							Clay H		5.5	1.00		N/A	N/A
							Separation		5.1	0.13		N/A	N/A
							Offset		0.6	0.75		25	0.22
							Separation		0.6	6.00		N/A	N/A

<sup>1</sup> Fr = Number of fractures in immediate roof beam

<sup>2</sup> Number of fracture zones in immediate roof beam

<sup>3</sup> Fracture Density = (Fr + 2 FZ) / Beam Height

**Table 6-1 (continued)**  
**Observation Borehole Fractures and Offset Data Summary**

Hole	Location	Initial Inspect. Date	Recent Inspect. Date	Fr <sup>1</sup>	FZ <sup>2</sup>	Beam Height (ft)	Feature	Fracture Density <sup>3</sup>	Feature Depth (ft)	Feature Magnitude (in)	Hole Dia. (in)	Hole Closure (%)	Offset Rate (in/yr)
<b>East 140 (continued)</b>													
OH 605	S3380 - E140	08/09/05	06/04/07	5	0	6.0	Offset	0.83	6.0	0.38	3.00	13	0.21
							Clay H		6.0	3.00		N/A	N/A
							Offset		5.9	0.38		13	0.21
							Separation		5.9	0.75		N/A	N/A
							Separation		5.4	0.13		N/A	N/A
							Separation		5.3	0.13		N/A	N/A
							Offset		2.0	1.50		50	0.82
							Separation		2.0	3.50		N/A	N/A
							Offset		1.2	1.25		42	0.69
OH 571	S3480 - E140	02/28/05	06/04/07	2	0	5.2	Clay H	0.38	5.2	0.38	3.00	N/A	N/A
							Separation		4.4	0.13		N/A	N/A
							Separation		0.8	0.06		N/A	N/A
OH 606	S3486 - E140	09/01/05	06/04/07	4	0	5.2	Separation	0.77	6.5	0.13	3.00	N/A	N/A
							Offset		5.2	0.38		13	0.21
							Clay H		5.2	0.38		N/A	N/A
							Separation		4.5	0.13		N/A	N/A
							Separation		4.2	0.13		N/A	N/A
							Separation		1.7	0.06		N/A	N/A
							Separation		0.5	0.25		N/A	N/A
OH 607	S3580 - E140	09/01/05	06/04/07	1	0	5.3	Separation	0.19	6.9	0.13	3.00	N/A	N/A
							Clay H		5.3	0.38		N/A	N/A
							Separation		0.8	0.13		N/A	N/A
OH 567	S3650 - E140	06/21/05	06/04/07	0	0	5.1	Offset	0.00	6.5	0.25	3.00	8	0.13
							Separation		6.5	0.13		N/A	N/A
							Offset		5.1	1.00		33	0.51
							Clay H		5.1	0.06		N/A	N/A

<sup>1</sup> Fr = Number of fractures in immediate roof beam  
<sup>2</sup> Number of fracture zones in immediate roof beam  
<sup>3</sup> Fracture Density = (Fr + 2 FZ) / Beam Height

**Table 6-1 (continued)**  
**Observation Borehole Fractures and Offset Data Summary**

Hole	Location	Initial Inspect. Date	Recent Inspect. Date	Fr <sup>1</sup>	FZ <sup>2</sup>	Beam Height (ft)	Feature	Fracture Density <sup>3</sup>	Feature Depth (ft)	Feature Magnitude (in)	Hole Dia. (in)	Hole Closure (%)	Offset Rate (in/yr)
<b>Panel 4 Room 1</b>													
OH 529	S3380 - E520	03/14/05	06/14/07	2	0	5.6	Separation Offset Clay H Separation Offset Separation	0.36	6.2 5.6 5.6 5.5 5.2 5.2	0.38 0.38 2.00 0.13 0.38 0.13	3.00	N/A 13 N/A N/A 13 N/A	N/A 0.17 N/A N/A 0.17 N/A
OH 530	S3480 - E520	03/14/05	06/14/07	3	0	5.2	Offset Clay H Separation Separation Separation	0.58	5.2 5.2 4.8 4.7 1.4	3.00 1.50 0.25 0.13 0.13	3.00	100 N/A N/A N/A N/A	1.33 N/A N/A N/A N/A
OH 531	S3580 - E520	03/14/05	06/14/07	1	0	5.4	Separation Separation Separation Offset Clay H Separation	0.19	6.4 6.1 5.8 5.4 5.4 5.3	0.13 0.38 0.38 1.25 1.00 0.13	3.00	N/A N/A N/A 42 N/A N/A	N/A N/A N/A 0.56 N/A N/A
<b>Panel 4 Room 2</b>													
OH 534	S3380 - E660	08/22/05	06/14/07	0	0	5.1	Clay H	0.00	5.1	2.25	3.00	N/A	N/A
OH 535	S3480 - E660	07/13/05	06/14/07	0	0	5.7	Separation Offset Clay H	0.00	6.4 5.7 5.7	0.25 0.75 0.75	3.00	N/A 25 N/A	N/A 0.39 N/A
OH 536	S3580 - E660	07/13/05	06/14/07	1	0	5.9	Clay H Separation	0.17	5.9 5.0	0.75 0.13	3.00	N/A N/A	N/A N/A

<sup>1</sup> Fr = Number of fractures in immediate roof beam  
<sup>2</sup> Number of fracture zones in immediate roof beam  
<sup>3</sup> Fracture Density = (Fr + 2 FZ) / Beam Height



**Table 6-1 (continued)**  
**Observation Borehole Fractures and Offset Data Summary**

Hole	Location	Initial Inspect. Date	Recent Inspect. Date	Fr <sup>1</sup>	FZ <sup>2</sup>	Beam Height (ft)	Feature	Fracture Density <sup>3</sup>	Feature Depth (ft)	Feature Magnitude (in)	Hole Dia. (in)	Hole Closure (%)	Offset Rate (in/yr)
<b>Panel 4 Room 3</b>													
OH 539	S3380 - E790	08/22/05	06/14/07	1	0	5.6	Offset Separation Offset Clay H Separation	0.18	6.1 6.1 5.6 5.6 5.2	0.75 0.25 0.25 0.13 0.13	3.00	25 N/A 8 N/A N/A	0.41 N/A 0.14 N/A N/A
OH 540	S3480 - E790	08/22/05	06/14/07	0	0	5.8	Separation Offset Clay H	0.00	6.5 5.8 5.8	0.50 1.00 1.00	3.00	N/A 17 N/A	N/A 0.28 N/A
OH 541	S3580 - E790	08/22/05	06/14/07	2	0	5.8	Offset Clay H Offset Separation Offset Separation	0.34	5.8 5.8 5.7 5.7 5.4 5.4	0.38 2.00 0.50 0.13 0.38 0.13	3.00	13 N/A 17 N/A 13 N/A	0.21 N/A 0.28 N/A 0.21 N/A
<b>Panel 4 Room 4</b>													
OH 544	S3380 - E920	09/01/05	06/14/07	0	0	5.7	Separation Offset Separation Separation Offset Clay H	0.00	6.5 6.1 6.1 5.8 5.7 5.7	0.13 0.50 0.25 0.25 0.38 0.25	3.00	N/A 17 N/A N/A 13 N/A	N/A 0.28 N/A N/A 0.21 N/A
OH 545	S3480 - E920	09/01/05	06/14/07	1	0	5.3	Separation Separation Offset Clay H Separation	0.19	7.4 6.5 5.3 5.3 4.5	0.13 1.00 1.75 2.00 0.38	3.00	N/A N/A 58 N/A N/A	N/A N/A 0.98 N/A N/A
OH 546	S3580 - E920	08/22/05	06/14/07	1	0	5.9	Offset Clay H Separation	0.17	5.9 5.9 5.5	0.38 0.50 0.13	3.00	13 N/A N/A	0.21 N/A N/A

<sup>1</sup> Fr = Number of fractures in immediate roof beam  
<sup>2</sup> Number of fracture zones in immediate roof beam  
<sup>3</sup> Fracture Density = (Fr + 2 FZ) / Beam Height

**Table 6-1 (continued)**  
**Observation Borehole Fractures and Offset Data Summary**

Hole	Location	Initial Inspect. Date	Recent Inspect. Date	Fr <sup>1</sup>	FZ <sup>2</sup>	Beam Height (ft)	Feature	Fracture Density <sup>3</sup>	Feature Depth (ft)	Feature Magnitude (in)	Hole Dia. (in)	Hole Closure (%)	Offset Rate (in/yr)
<b>Panel 4 Room 5</b>													
OH 549	S3380 - E1050	03/17/06	02/07/07	1	0	5.9	Clay H Separation	0.17	5.9 4.9	0.38 0.13	3.00	N/A N/A	N/A N/A
OH 550	S3480 - E1050	03/17/06	02/07/07	0	0	5.8	Separation Separation Clay H	0.00	6.5 6.3 5.8	0.13 0.13 0.25	3.00	N/A N/A N/A	N/A N/A N/A
OH551	S3580 - E1050	03/17/06	02/07/07	0	0	5.9	Separation Separation Clay H	0.00	7.1 6.5 5.9	0.13 0.13 0.38	3.00	N/A N/A N/A	N/A N/A N/A
<b>Panel 4 Room 6</b>													
OH 554	S3380 - E1180	12/20/05	12/07/06	0	0	6.0	Clay H	0.00	6.0	0.13	3.00	N/A	N/A
OH 555	S3480 - E1180	09/01/05	11/28/06	0	0	5.7	Separation Offset Clay H	0.00	6.1 5.7 5.7	0.13 0.25 0.38	3.00	N/A 8 N/A	N/A 0.20 N/A
OH 556	S3580 - E1180	08/22/05	08/28/06	0	0	6.1	Separation Separation Clay H	0.00	6.5 6.4 6.1	0.13 0.13 0.13	3.00	N/A N/A N/A	N/A N/A N/A
<b>Panel 4 Room 7</b>													
OH 559	S3380 - E1320	12/19/05	02/06/07	0	0	6.0	Clay H	0.00	6.0	0.50	3.00	N/A	N/A
OH 560	S3480 - E1320	12/19/05	02/06/07	0	0	5.8	Offset Separation Offset Clay H	0.00	6.3 6.3 5.8 5.8	0.06 0.25 0.25 0.25	3.00	2 N/A 8 N/A	0.06 N/A 0.22 N/A
OH 561	S3580 - E1320	12/19/05	02/06/07	0	0	6.0	Separation Offset Clay H	0.00	6.4 6.0 6.0	0.13 0.06 0.13	3.00	N/A 2 N/A	N/A 0.06 N/A

<sup>1</sup> Fr = Number of fractures in immediate roof beam

<sup>2</sup> Number of fracture zones in immediate roof beam

<sup>3</sup> Fracture Density = (Fr + 2 FZ) / Beam Height

**Table 6-1 (continued)**  
**Observation Borehole Fractures and Offset Data Summary**

Hole	Location	Initial Inspect. Date	Recent Inspect. Date	Fr <sup>1</sup>	FZ <sup>2</sup>	Beam Height (ft)	Feature	Fracture Density <sup>3</sup>	Feature Depth (ft)	Feature Magnitude (in)	Hole Dia. (in)	Hole Closure (%)	Offset Rate (in/yr)
<b>South 3310 (continued)</b>													
OH 528	S3310 - E520	02/23/05	06/18/07	1	0	5.1	Offset	0.20	5.6	2.50	3.00	83	1.08
							Separation		5.6	0.13		N/A	N/A
							Offset		5.1	1.00		33	0.43
							Clay H		5.1	0.13		N/A	N/A
							Separation		0.4	0.25		N/A	N/A
OH 592	S3310 - E592	07/13/05	06/18/07	1	0	5.8	Separation	0.17	6.5	0.38	3.00	N/A	N/A
							Offset		5.8	1.50		50	0.78
							Clay H		5.8	0.38		N/A	N/A
							Separation		5.6	0.25		N/A	N/A
OH 533	S3310 - E660	07/13/05	06/18/07	1	0	5.4	Offset	0.19	16.2	0.25	3.00	8	0.13
							Offset		7.5	1.25		42	0.65
							Separation		6.5	0.38		N/A	N/A
							Offset		6.3	1.50		50	0.78
							Separation		6.3	0.13		N/A	N/A
							Offset		5.9	1.50		50	0.78
							Separation		5.9	0.38		N/A	N/A
							Offset		5.4	0.38		13	0.19
							Clay H		5.4	0.50		N/A	N/A
							Separation		1.4	0.13		N/A	N/A
OH 593	S3310 - E723	07/13/05	06/18/07	5	0	5.7	Offset	0.88	5.7	3.00	3.00	100	1.55
							Clay H		5.7	0.13		N/A	N/A
							Separation		5.6	0.25		N/A	N/A
							Separation		5.4	1.00		N/A	N/A
							Separation		4.9	0.13		N/A	N/A
							Separation		4.5	0.13		N/A	N/A
							Separation		1.2	0.13		N/A	N/A

<sup>1</sup> Fr = Number of fractures in immediate roof beam  
<sup>2</sup> Number of fracture zones in immediate roof beam  
<sup>3</sup> Fracture Density = (Fr + 2 FZ) / Beam Height

**Table 6-1 (continued)**  
**Observation Borehole Fractures and Offset Data Summary**

Hole	Location	Initial Inspect. Date	Recent Inspect. Date	Fr <sup>1</sup>	FZ <sup>2</sup>	Beam Height (ft)	Feature	Fracture Density <sup>3</sup>	Feature Depth (ft)	Feature Magnitude (in)	Hole Dia. (in)	Hole Closure (%)	Offset Rate (in/yr)
<b>South 3310 (continued)</b>													
OH 538	S3310 - E790	07/13/05	06/18/07	3	0	5.9	Offset	0.51	16.4	0.25	3.00	8	0.13
							Offset		6.4	1.75		58	0.91
							Separation		6.4	0.13		N/A	N/A
							Offset		5.9	1.50		50	0.78
							Clay H		5.9	0.25		N/A	N/A
							Separation		5.0	0.13		N/A	N/A
							Separation		2.4	0.13		N/A	N/A
Separation	1.5	0.13	N/A	N/A									
OH 594	S3310 - E855	07/13/05	06/18/07	2	0	5.4	Separation	0.37	7.7	1.25	3.00	N/A	N/A
							Separation		6.6	0.13		N/A	N/A
							Separation		6.2	0.13		N/A	N/A
							Separation		5.5	0.50		N/A	N/A
							Offset		5.4	0.75		25	0.39
							Clay H		5.4	0.50		N/A	N/A
							Separation		5.2	0.38		N/A	N/A
Separation	1.6	0.13	N/A	N/A									
OH 543	S3310 - E920	07/13/05	06/18/07	1	0	5.7	Offset	0.18	5.7	2.50	3.00	83	1.29
							Clay H		5.7	0.75		N/A	N/A
							Separation		1.3	0.13		N/A	N/A
OH 616	S3310 - E990	10/11/05	06/18/07	1	0	5.7	Offset	0.18	5.7	1.50	3.00	50	0.89
							Clay H		5.7	1.00		N/A	N/A
							Separation		5.2	0.13		N/A	N/A
OH 548	S3310 - E1060	10/11/05	02/08/07	1	0	5.7	Separation	0.18	7.2	0.13	3.00	N/A	N/A
							Offset		5.7	1.50		50	1.13
							Clay H		5.7	0.25		N/A	N/A
							Separation		5.3	0.25		N/A	N/A

<sup>1</sup> Fr = Number of fractures in immediate roof beam  
<sup>2</sup> Number of fracture zones in immediate roof beam  
<sup>3</sup> Fracture Density = (Fr + 2 FZ) / Beam Height

**Table 6-1 (continued)**  
**Observation Borehole Fractures and Offset Data Summary**

Hole	Location	Initial Inspect. Date	Recent Inspect. Date	Fr <sup>1</sup>	FZ <sup>2</sup>	Beam Height (ft)	Feature	Fracture Density <sup>3</sup>	Feature Depth (ft)	Feature Magnitude (in)	Hole Dia. (in)	Hole Closure (%)	Offset Rate (in/yr)
<b>South 3310 (continued)</b>													
OH 618	S3310 - E1120	10/11/05	02/08/07	1	0	6.0	Offset Clay H Separation	0.17	6.0 6.0 5.2	2.25 0.13 0.13	3.00	75 N/A N/A	1.69 N/A N/A
OH 553	S3310 - E1181	10/11/05	02/08/07	2	0	5.9	Separation Separation Offset Clay H Separation Offset Separation	0.34	7.6 6.4 5.9 5.9 5.3 1.0 1.0	0.50 0.38 2.00 0.38 0.13 0.25 0.25	3.00	N/A N/A 13 N/A N/A 8 N/A	N/A N/A 0.28 N/A N/A 0.19 N/A
OH 619	S3310 - E1250	10/17/05	02/06/07	2	0	5.8	Offset Clay H Separation Separation	0.34	5.8 5.8 5.7 5.4	0.50 0.25 0.13 0.13	3.00	17 N/A N/A N/A	0.38 N/A N/A N/A
OH558	S3310 - E1316	12/19/05	02/06/07	0	0	5.6	Offset Separation Offset Clay H	0.00	6.2 6.2 5.6 5.6	1.50 0.25 0.50 0.50	3.00	50 N/A 17 N/A	1.32 N/A 0.44 N/A
<b>South 3650</b>													
OH 532	S3650 - E520	02/23/05	06/04/07	0	0	5.7	Offset Offset Separation Offset Clay H	0.00	16.0 6.4 6.4 5.7 5.7	0.13 2.00 0.38 1.50 0.13	3.00	4 67 N/A 50 N/A	0.05 0.88 N/A 0.66 N/A

<sup>1</sup> Fr = Number of fractures in immediate roof beam

<sup>2</sup> Number of fracture zones in immediate roof beam

<sup>3</sup> Fracture Density = (Fr + 2 FZ) / Beam Height

**Table 6-1 (continued)**  
**Observation Borehole Fractures and Offset Data Summary**

Hole	Location	Initial Inspect. Date	Recent Inspect. Date	Fr <sup>1</sup>	FZ <sup>2</sup>	Beam Height (ft)	Feature	Fracture Density <sup>3</sup>	Feature Depth (ft)	Feature Magnitude (in)	Hole Dia. (in)	Hole Closure (%)	Offset Rate (in/yr)
<b>South 3650 (continued)</b>													
OH 595	S3650 - E592	08/22/05	06/04/07	1	0	5.7	Separation	0.18	7.2	0.13	3.00	N/A	N/A
							Separation		6.0	0.38		N/A	N/A
							Separation		5.9	0.13		N/A	N/A
							Offset		5.7	0.38		13	0.21
							Clay H		5.7	0.13		N/A	N/A
Separation	5.3	0.13	N/A	N/A									
OH 537	S3650 - E660	07/18/05	06/04/07	0	0	5.2	Offset	0.00	6.6	0.50	3.00	17	0.27
							Separation		6.6	2.00		N/A	N/A
							Offset		5.2	0.50		17	0.27
							Clay H		5.2	0.13		N/A	N/A
OH 630	S3650 - E725	06/12/06	06/04/07	1	0	5.8	Separation	0.17	6.4	0.25	3.00	N/A	N/A
							Offset		5.8	0.13		4	0.13
							Clay H		5.8	0.75		N/A	N/A
							Separation		5.3	0.13		N/A	N/A
OH 596	S3650 - E758	08/22/05	06/04/07	0	0	5.4	Offset	0.00	6.1	0.75	3.00	25	0.42
							Separation		6.1	0.50		N/A	N/A
							Offset		5.4	0.75		25	0.42
							Clay H		5.4	0.13		N/A	N/A
OH 542	S3650 - E790	08/22/05	06/04/07	1	0	5.5	Offset	0.18	6.1	0.13	3.00	4	0.07
							Separation		6.1	0.50		N/A	N/A
							Offset		5.5	0.25		8	0.14
							Clay H		5.5	0.75		N/A	N/A
							Separation		4.8	0.06		N/A	N/A

<sup>1</sup> Fr = Number of fractures in immediate roof beam  
<sup>2</sup> Number of fracture zones in immediate roof beam  
<sup>3</sup> Fracture Density = (Fr + 2 FZ) / Beam Height

**Table 6-1 (continued)**  
**Observation Borehole Fractures and Offset Data Summary**

Hole	Location	Initial Inspect. Date	Recent Inspect. Date	Fr <sup>1</sup>	FZ <sup>2</sup>	Beam Height (ft)	Feature	Fracture Density <sup>3</sup>	Feature Depth (ft)	Feature Magnitude (in)	Hole Dia. (in)	Hole Closure (%)	Offset Rate (in/yr)
<b>South 3650 (continued)</b>													
OH 611	S3650 - E855	08/22/05	06/04/07	0	0	5.8	Clay H	0.00	5.8	1.00	3.00	N/A	N/A
OH 547	S3650 - E920	08/22/05	06/04/07	0	0	5.6	Separation Offset Clay H	0.00	6.0 5.6 5.6	1.50 2.00 0.50	3.00	N/A 67 N/A	N/A 1.12 N/A
OH 617	S3650 - E990	10/11/05	06/04/07	4	0	5.6	Separation Separation Offset Clay H Separation Separation Offset Separation Offset Separation	0.71	7.2 6.1 5.6 5.6 4.9 2.0 1.1 1.1 0.6 0.6	0.25 0.50 1.50 1.50 0.13 0.13 0.06 0.13 0.38 0.06	3.00	N/A N/A 50 N/A N/A N/A 2 N/A 13 N/A	N/A N/A 0.91 N/A N/A N/A 0.04 N/A 0.23 N/A
OH 552	S3650 - E1060	10/11/05	02/07/07	0	0	5.7	Separation Offset Clay H	0.00	7.3 5.7 5.7	1.00 1.50 2.00	3.00	N/A 50 N/A	N/A 1.13 N/A
OH 626	S3650 - E1120	06/12/06	02/06/07	1	0	5.3	Separation Offset Clay H Separation	0.19	7.0 5.3 5.3 4.7	0.25 0.13 1.00 0.13	3.00	N/A 4 N/A N/A	N/A 0.19 N/A N/A
OH 557	S3650 - E1180	06/12/06	02/06/07	0	0	5.9	Separation Offset Clay H	0.00	7.5 5.9 5.9	0.75 0.13 0.25	3.00	N/A 4 N/A	N/A 0.19 N/A
OH 625	S3650 - E1255	06/12/06	02/06/07	0	0	6.4	Clay H	0.00	6.4	0.13	3.00	N/A	N/A

<sup>1</sup> Fr = Number of fractures in immediate roof beam  
<sup>2</sup> Number of fracture zones in immediate roof beam  
<sup>3</sup> Fracture Density = (Fr + 2 FZ) / Beam Height

**Table 6-1 (continued)**  
**Observation Borehole Fractures and Offset Data Summary**

Hole	Location	Initial Inspect. Date	Recent Inspect. Date	Fr <sup>1</sup>	FZ <sup>2</sup>	Beam Height (ft)	Feature	Fracture Density <sup>3</sup>	Feature Depth (ft)	Feature Magnitude (in)	Hole Dia. (in)	Hole Closure (%)	Offset Rate (in/yr)
<b>South 3650 (continued)</b>													
OH 562	S3650 - E1320	01/03/06	02/06/07	0	0	5.8	Separation Offset Clay H	0.00	6.5 5.8 5.8	0.13 0.25 0.13	3.00	N/A 8 N/A	N/A 0.23 N/A
OH 564	S3650 - W90	04/20/05	06/18/07	0	0	5.7	Offset Clay H	0.00	5.7 5.7	0.13 0.13	3.00	4 N/A	0.06 N/A
OH 566	S3650 - E90	06/21/05	06/18/07	0	0	6.1	Offset Clay H	0.00	6.1 6.1	0.13 0.38	3.00	4 N/A	0.06 N/A
OH 568	S3650 - E235	06/21/05	06/04/07	0	0	5.8	Clay H	0.00	5.8	0.06	3.00	N/A	N/A
OH 569	S3650 - E300	04/20/05	06/04/07	0	0	5.8	Offset Clay H	0.00	5.8 5.8	0.25 0.06	3.00	8 N/A	0.12 N/A
<b>West 30</b>													
OH 455	S2913 - W17	08/28/03	06/14/07	0	0	6.3	Clay H	0.00	6.3	0.13	3.00	N/A	N/A
OH 456	S2950 - W30	08/28/03	06/14/07	2	0	5.9	Separation Clay H Separation Offset Separation	0.34	6.2 5.9 1.5 1.5 0.9	0.13 0.38 0.25 2.00 0.13	3.00	N/A N/A N/A 67 N/A	N/A N/A N/A 0.53 N/A
OH 463	S3079 - W17	09/03/03	06/14/07	1	0	5.8	Separation Separation Separation Offset Clay H Offset Separation	0.17	7.4 6.4 6.1 5.8 5.8 1.5 1.5	0.13 0.13 0.13 1.00 0.38 1.00 2.00	3.00	N/A N/A N/A 33 N/A 33 N/A	N/A N/A N/A 0.26 N/A 0.03 N/A

<sup>1</sup> Fr = Number of fractures in immediate roof beam

<sup>2</sup> Number of fracture zones in immediate roof beam

<sup>3</sup> Fracture Density = (Fr + 2 FZ) / Beam Height



**Table 6-1 (continued)**  
**Observation Borehole Fractures and Offset Data Summary**

Hole	Location	Initial Inspect. Date	Recent Inspect. Date	Fr <sup>1</sup>	FZ <sup>2</sup>	Beam Height (ft)	Feature	Fracture Density <sup>3</sup>	Feature Depth (ft)	Feature Magnitude (in)	Hole Dia. (in)	Hole Closure (%)	Offset Rate (in/yr)
<b>West 30 (continued)</b>													
OH 465	S3200 - W17	02/28/05	06/18/07	2	0	5.7	Clay H Separation Separation	0.35	5.7 1.5 1.0	0.13 0.13 0.13	3.00	N/A N/A N/A	N/A N/A N/A
OH 449	S3314 - W18	08/28/03	06/18/07	1	0	6.0	Offset Clay H Separation	0.17	6.0 6.0 5.2	0.25 0.13 0.13	3.00	8 N/A N/A	0.07 N/A N/A
OH 514	S3400 - W30	12/08/04	06/18/07	-	-	6.0 <sup>4</sup>	No Separations		-	-	3.00	N/A	N/A
OH 515	S3490 - W30	12/08/04	06/18/07	0	0	5.6	Offset Clay H	0.00	5.6 5.6	0.13 1.00	3.00	4 N/A	0.05 N/A
OH 526	S3590 - W30	12/08/04	06/18/07	0	0	6.0	Offset Clay H	0.00	6.0 6.0	0.13 0.13	3.00	4 N/A	0.05 N/A
OH 565	S3650 - W17	02/28/05	06/18/07	0	0	5.9	Offset Clay H	0.00	5.9 5.9	0.25 0.13	3.00	8 N/A	0.11 N/A
<b>West 170</b>													
OH 441	S2750 - W170	08/18/03	06/18/07	2	0	5.6	Separation Offset Clay H Separation Offset Separation	0.36	6.0 5.6 5.6 3.7 1.4 1.4	0.13 0.25 1.00 0.13 0.13 0.50	3.00	N/A 8 N/A N/A 4 N/A	N/A 0.10 N/A N/A 0.03 N/A
OH 442	S2820 - W170	08/18/03	06/18/07	0	0	5.7	Clay H	0.00	5.7	0.13	3.00	N/A	N/A
OH 444	S3000 - W170	08/13/03	06/18/07	1	0	5.8	Separation Offset Clay H Offset Separation	0.17	6.0 5.8 5.8 1.5 1.5	0.13 0.25 0.13 0.13 3.00	3.00	N/A 8 N/A 4 N/A	N/A 0.03 N/A 0.13 N/A

<sup>1</sup> Fr = Number of fractures in immediate roof beam  
<sup>2</sup> Number of fracture zones in immediate roof beam  
<sup>3</sup> Fracture Density = (Fr + 2 FZ) / Beam Height  
<sup>4</sup> Beam height estimated

**Table 6-1 (continued)**  
**Observation Borehole Fractures and Offset Data Summary**

Hole	Location	Initial Inspect. Date	Recent Inspect. Date	Fr <sup>1</sup>	FZ <sup>2</sup>	Beam Height (ft)	Feature	Fracture Density <sup>3</sup>	Feature Depth (ft)	Feature Magnitude (in)	Hole Dia. (in)	Hole Closure (%)	Offset Rate (in/yr)
<b>West 170 (continued)</b>													
OH 445	S3079 - W170	08/18/03	06/18/07				Offset		5.6	0.75	3.00	25	0.20
							Separation		5.6	0.13		N/A	N/A
							Offset		5.5	0.25		8	0.07
							Separation		5.5	0.13		N/A	N/A
							Offset		5.2	0.75		25	0.20
				2	0	5.2	Clay H	0.38	5.2	0.13		N/A	N/A
							Offset		1.0	0.75		25	0.20
							Separation		1.0	0.13		N/A	N/A
							Offset		0.3	0.75		25	0.20
							Separation		0.3	0.13		N/A	N/A
OH 446	S3198 - W170	08/28/03	04/18/07	1	0	5.9	Clay H	0.17	5.9	0.13	3.00	N/A	N/A
							Separation		1.5	0.13		N/A	N/A
OH 447	S3314 - W170	08/28/03	06/18/07				Offset		5.9	1.00	3.00	33	0.26
				0	0	5.9	Clay H	0.00	5.9	0.13		N/A	N/A
OH 608	S3380 - W170	09/01/05	06/18/07	1	0	5.8	Clay H	0.17	5.8	0.13	3.00	N/A	N/A
							Separation		5.4	0.13		N/A	N/A
OH 609	S3480 - W170	09/01/05	06/18/07				Separation		6.0	0.13	3.00	N/A	N/A
				0	0	5.5	Clay H	0.00	5.5	2.00		N/A	N/A
<b>South 2750</b>													
OH 460	S2750 - W100	09/03/03	06/14/07				Offset		6.2	1.25	3.00	42	0.33
				1	0	6.2	Clay H	0.16	6.2	0.38		N/A	N/A
							Offset		1.2	0.19		6	0.05
							Separation		1.2	1.00		N/A	N/A

<sup>1</sup> Fr = Number of fractures in immediate roof beam

<sup>2</sup> Number of fracture zones in immediate roof beam

<sup>3</sup> Fracture Density = (Fr + 2 FZ) / Beam Height

**Table 6-1 (continued)**  
**Observation Borehole Fractures and Offset Data Summary**

Hole	Location	Initial Inspect. Date	Recent Inspect. Date	Fr <sup>1</sup>	FZ <sup>2</sup>	Beam Height (ft)	Feature	Fracture Density <sup>3</sup>	Feature Depth (ft)	Feature Magnitude (in)	Hole Dia. (in)	Hole Closure (%)	Offset Rate (in/yr)
<b>South 3080</b>													
OH 462	S3082 - W91	09/03/03	06/14/07	2	0	5.7	Separation Clay H Separation Separation	0.35	6.2 5.7 5.3 1.3	0.13 0.13 0.25 0.25	3.00	N/A N/A N/A N/A	N/A N/A N/A N/A
OH 464	S3080 - E65	09/03/03	06/14/07	1	0	5.4	Offset Separation Offset Clay H Separation	0.19	6.1 6.1 5.4 5.4 0.9	0.06 0.13 0.25 0.13 0.13	3.00	2 N/A 8 N/A N/A	0.02 N/A 0.07 N/A N/A
OH 503	S3080 - E230	04/12/04	06/22/07	1	0	5.8	Offset Clay H Offset Separation	0.17	5.8 5.8 5.0 5.0	0.25 0.13 0.13 0.25	3.00	8 N/A 4 N/A	0.08 N/A 0.04 N/A
<b>South 3310</b>													
OH 450	S3310 - E65	08/28/03	06/18/07	1	0	5.2	Offset Clay H Separation	0.19	5.2 5.2 0.9	0.25 0.13 0.25	3.00	8 N/A N/A	0.07 N/A N/A
OH 452	S3310 - E230	08/28/03	06/26/07	2	0	6.0	Offset Clay H Separation Separation	0.33	6.0 6.0 5.4 1.1	0.25 0.13 0.13 0.13	3.00	8 N/A N/A N/A	0.07 N/A N/A N/A

<sup>1</sup> Fr = Number of fractures in immediate roof beam

<sup>2</sup> Number of fracture zones in immediate roof beam

<sup>3</sup> Fracture Density = (Fr + 2 FZ) / Beam Height

**Table 6-1 (continued)**  
**Observation Borehole Fractures and Offset Data Summary**

Hole	Location	Initial Inspect. Date	Recent Inspect. Date	Fr <sup>1</sup>	FZ <sup>2</sup>	Beam Height (ft)	Feature	Fracture Density <sup>3</sup>	Feature Depth (ft)	Feature Magnitude (in)	Hole Dia. (in)	Hole Closure (%)	Offset Rate (in/yr)
<b>North End</b>													
OH492	N780 - E140	01/09/04	06/21/07	0	0	7.8	Offset Clay H	0.00	7.8 7.8	0.06 0.13	3.00	2 N/A	0.02 N/A
OH483	N940 - E140	01/07/04	06/21/07	1	0	6.6	Offset Clay H Offset Separation	0.15	6.6 6.6 1.5 1.5	0.38 0.25 0.25 0.50	3.00	13 N/A 8 N/A	0.11 N/A 0.07 N/A
OH484	N1265 - E140	01/07/04	06/11/07	0	0	5.6	Clay H	0.00	5.6	0.13	3.00	N/A	N/A
OH485	N1400 - E140	01/07/04	06/21/07	0	0	6.6	Offset Clay H	0.00	6.6 6.6	0.75 0.25	3.00	25 N/A	0.22 N/A
OH491	N620 - E0	01/09/04	06/21/07	0	0	6.2	Offset Clay H	0.00	6.2 6.2	1.00 0.13	3.00	33 N/A	0.29 N/A
OH490	N780 - E0	01/09/04	06/21/07	0	0	6.0	Offset Separation Offset Clay H	0.00	6.7 6.7 6.0 6.0	0.38 0.13 0.25 0.13	3.00	13 N/A 8 N/A	0.11 N/A 0.07 N/A
OH488	N1100 - E0	01/07/04	06/21/07	0	0	6.0	Separation Clay H	0.00	6.4 6.0	0.13 0.13	3.00	N/A N/A	N/A N/A
OH487	N1268 - E0	01/07/04	06/21/07	1	0	5.2	Separation Clay H Separation	0.19	6.9 5.2 1.6	0.13 0.13 1.25	3.00	N/A N/A N/A	N/A N/A N/A
OH486	N1400 - E0	01/07/04	06/21/07	1	0	6.4	Offset Separation Offset Clay H Separation	0.16	6.8 6.8 6.4 6.4 1.4	0.38 0.13 0.25 0.13 0.13	3.00	13 N/A 8 N/A N/A	0.11 N/A 0.07 N/A N/A

<sup>1</sup> Fr = Number of fractures in immediate roof beam  
<sup>2</sup> Number of fracture zones in immediate roof beam  
<sup>3</sup> Fracture Density = (Fr + 2 FZ) / Beam Height

**Table 6-1 (continued)**  
**Observation Borehole Fractures and Offset Data Summary**

Hole	Location	Initial Inspect. Date	Recent Inspect. Date	Fr <sup>1</sup>	FZ <sup>2</sup>	Beam Height (ft)	Feature	Fracture Density <sup>3</sup>	Feature Depth (ft)	Feature Magnitude (in)	Hole Dia. (in)	Hole Closure (%)	Offset Rate (in/yr)
<b>Panel 5 Room 1</b>													
OH701	S3370 - W390	10/12/06	06/05/07	0	0	5.5	Separation	0.00	5.8	0.25	3.00	N/A	N/A
							Offset		5.5	0.13			
							Clay H		5.5	0.25			
OH702	S3470 - W390	10/12/06	06/05/07	0	0	5.3	Clay H	0.00	5.3	0.25	3.00	N/A	N/A
OH703	S3570 - W390	10/12/06	06/05/07	1	0	5.5	Clay H	0.18	5.5	0.13	3.00	N/A	N/A
							Separation		5.0	0.38			
<b>Panel 5 Room 2</b>													
OH704	S3370 - W530	02/06/07	06/05/07	1	0	5.8	Clay H	0.17	5.8	0.13	3.00	N/A	N/A
							Separation		1.0	0.13			
OH705	S3470 - W530	02/06/07	06/05/07	0	0	5.3	Clay H	0.00	5.3	0.38	3.00	N/A	N/A
OH706	S3570 - W530	02/06/07	06/05/07	0	0	5.2	Clay H	0.00	5.2	0.25	3.00	N/A	N/A
<b>Panel 5 Room 3</b>													
OH707	S3370 - W660	04/04/07	06/05/07	0	0	5.6	Clay H	0.00	5.6	0.13	3.00	N/A	N/A
OH708	S3470 - W660	04/04/07	06/05/07	0	0	5.8	Clay H	0.00	5.8	0.13	3.00	N/A	N/A
OH709	S3570 - W660	04/04/07	06/05/07	0	0	5.4	Clay H	0.00	5.4	0.00	3.00	N/A	N/A
<b>Panel 5 Room 4</b>													
OH710	S3370 - W790	06/05/07	06/05/07	0	0	5.7	Clay H	0.00	5.7	0.13	3.00	N/A	N/A
OH711	S3470 - W790	06/05/07	06/05/07	0	0	6.0	Clay H	0.00	6.0	0.13	3.00	N/A	N/A
OH712	S3570 - W790	06/05/07	06/05/07	0	0	5.7	Clay H	0.00	5.7	0.00	3.00	N/A	N/A
<b>Panel 5 Room 5</b>													
OH713	S3370 - W920	06/05/07	06/05/07	0	0	5.4	Clay H	0.00	5.4	0.00	3.00	N/A	N/A
OH714	S3470 - W920	06/05/07	06/05/07	0	0	5.6	Clay H	0.00	5.6	0.00	3.00	N/A	N/A
OH715	S3570 - W920	06/05/07	06/05/07	0	0	5.2	Clay H	0.00	5.2	0.00	3.00	N/A	N/A

<sup>1</sup> Fr = Number of fractures in immediate roof beam

<sup>2</sup> Number of fracture zones in immediate roof beam

<sup>3</sup> Fracture Density = (Fr + 2 FZ) / Beam Height

**Table 6-1 (continued)**  
**Observation Borehole Fractures and Offset Data Summary**

Hole	Location	Initial Inspect. Date	Recent Inspect. Date	Fr <sup>1</sup>	FZ <sup>2</sup>	Beam Height (ft)	Feature	Fracture Density <sup>3</sup>	Feature Depth (ft)	Feature Magnitude (in)	Hole Dia. (in)	Hole Closure (%)	Offset Rate (in/yr)
<b>Panel 5 South 3310</b>													
OH722	S3310 - W390	10/12/06	06/05/07	0	0	5.2	Separation Clay H	0.00	5.5 5.2	0.13 0.13	3.00	N/A N/A	N/A N/A
OH723	S3310 - W450	02/06/07	06/05/07	0	0	5.4	Clay H	0.00	5.4	0.00	3.00	N/A	N/A
OH724	S3310 - W530	02/06/07	06/05/07	2	0	5.8	Offset Clay H Separation Separation	0.34	5.8 5.8 1.6 0.6	0.25 0.25 0.13 0.13	3.00	8 N/A N/A N/A	0.77 N/A N/A N/A
OH725	S3310 - W590	04/04/07	06/05/07	0	0	5.7	Clay H	0.00	5.7	0.13	3.00	N/A	N/A
OH726	S3310 - W660	04/04/07	06/05/07	0	0	5.8	Clay H	0.00	5.8	0.13	3.00	N/A	N/A
OH727	S3310 - W725	04/04/07	06/05/07	1	0	5.5	Clay H Separation	0.18	5.5 0.4	0.13 0.13	3.00	N/A N/A	N/A N/A
OH728	S3310 - W790	04/04/07	06/05/07	0	0	5.5	Clay H	0.00	5.5	0.13	3.00	N/A	N/A
OH729	S3310 - W860	04/04/07	06/05/07	0	0	5.6	Clay H	0.00	5.6	0.13	3.00	N/A	N/A
OH730	S3310 - W925	04/04/07	06/05/07	0	0	5.4	Clay H	0.00	5.4	0.13	3.00	N/A	N/A
OH731	S3310 - W985	04/04/07	06/05/07	0	0	5.8	Separation Clay H	0.00	5.9 5.8	0.13 0.13	3.00	N/A N/A	N/A N/A
OH732	S3310 - W1060	04/04/07	04/04/07	0	0	5.6	Clay H	0.00	5.6	0.00	3.00	N/A	N/A
<b>Panel 5 South 3650</b>													
OH735	S3650 - W390	10/12/06	06/18/07	1	0	5.8	Separation Offset Clay H Separation	0.17	7.0 5.8 5.8 5.5	0.13 0.38 0.38 0.25	3.00	N/A 13 N/A N/A	N/A 0.55 N/A N/A
OH736	S3650 - W450	10/12/06	06/18/07	0	0	5.4	Separation Clay H	0.00	6.9 5.4	0.13 0.13	3.00	N/A N/A	N/A N/A

<sup>1</sup> Fr = Number of fractures in immediate roof beam

<sup>2</sup> Number of fracture zones in immediate roof beam

<sup>3</sup> Fracture Density = (Fr + 2 FZ) / Beam Height

**Table 6-1 (continued)**  
**Observation Borehole Fractures and Offset Data Summary**

Hole	Location	Initial Inspect. Date	Recent Inspect. Date	Fr <sup>1</sup>	FZ <sup>2</sup>	Beam Height (ft)	Feature	Fracture Density <sup>3</sup>	Feature Depth (ft)	Feature Magnitude (in)	Hole Dia. (in)	Hole Closure (%)	Offset Rate (in/yr)
<b>Panel 5 South 3650 (continued)</b>													
OH737	S3650 - W520	10/12/06	06/05/07	0	0	5.6	Separation Offset Clay H	0.00	6.0 5.6 5.6	0.13 0.25 0.13	3.00	N/A 8 N/A	N/A 0.39 N/A
OH738	S3650 - W590	10/12/07	06/05/07	0	0	5.8	Clay H	0.00	5.8	0.13	3.00	N/A	N/A
OH739	S3650 - W660	02/06/07	06/05/07	0	0	5.5	Separation Clay H	0.00	5.9 5.5	0.13 0.13	3.00	N/A N/A	N/A N/A
OH740	S3650 - W725	02/06/07	06/05/07	0	0	5.5	Clay H	0.00	5.5	0.13	3.00	N/A	N/A
OH741	S3650 - W790	04/04/07	06/05/07	0	0	5.3	Clay H	0.00	5.3	0.13	3.00	N/A	N/A
OH742	S3650 - W860	04/04/07	06/05/07	0	0	5.2	Clay H	0.00	5.2	0.13	3.00	N/A	N/A
OH743	S3650 - W920	06/05/07	06/05/07	0	0	5.8	Clay H	0.00	5.8	0.13	3.00	N/A	N/A
OH744	S3650 - W990	06/05/07	06/05/07	0	0	5.4	Clay H	0.00	5.4	0.00	3.00	N/A	N/A
OH745	S3650 - W1060	06/05/07	06/05/07	0	0	5.9	Clay H	0.00	5.9	0.13	3.00	N/A	N/A
OH746	S3650 - W1120	06/05/07	06/05/07	0	0	5.7	Clay H	0.00	5.7	0.13	3.00	N/A	N/A
OH747	S3650 - W1185	06/05/07	06/05/07	0	0	5.6	Separation Clay H	0.00	7.5 5.6	0.13 0.00	3.00	N/A N/A	N/A N/A

<sup>1</sup> Fr = Number of fractures in immediate roof beam

<sup>2</sup> Number of fracture zones in immediate roof beam

<sup>3</sup> Fracture Density = (Fr + 2 FZ) / Beam Height

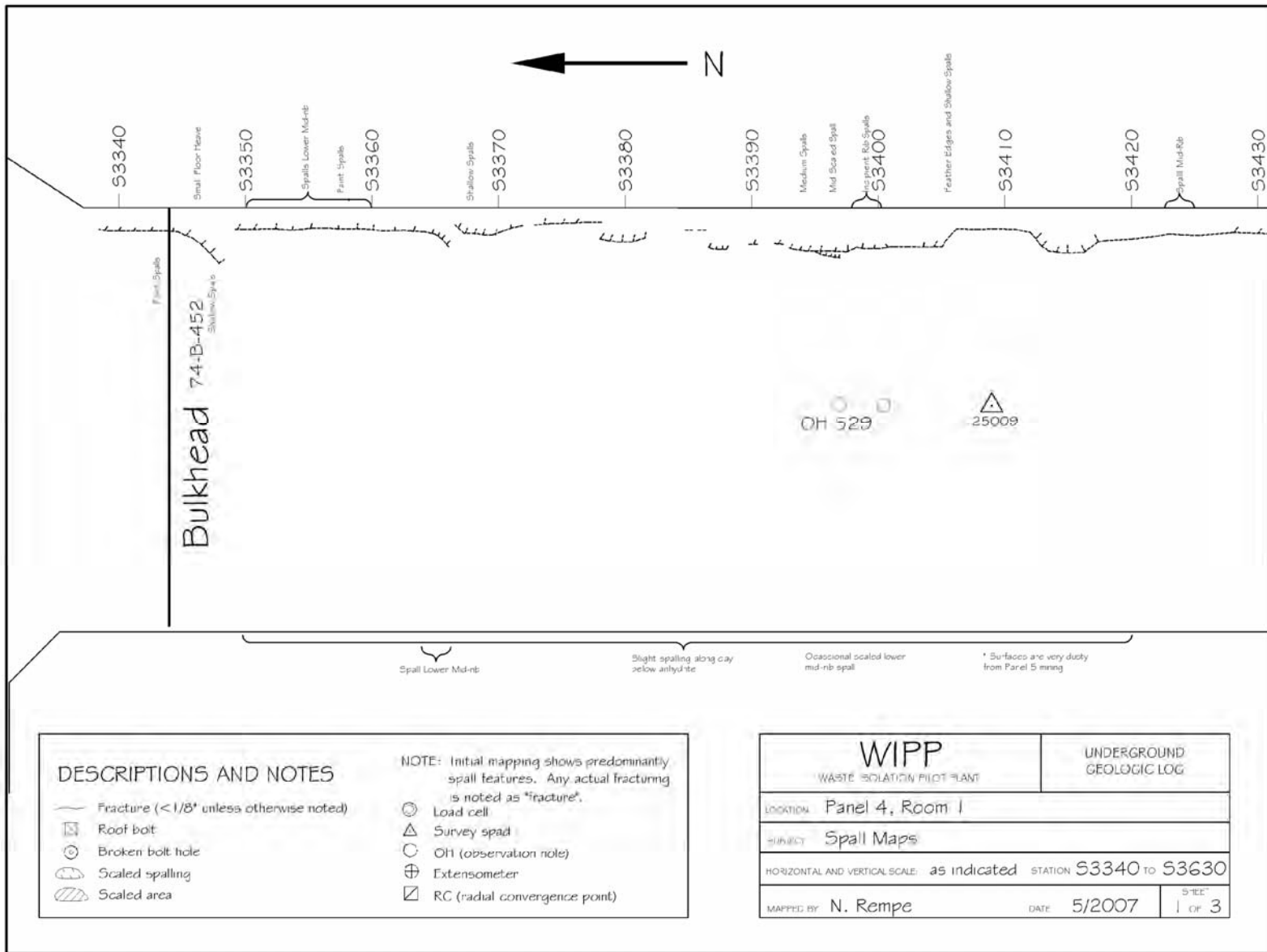


Figure 6-1  
Panel 4 Room 1, S3340 – S3630 Roof Fractures (Sheet 1 of 3)



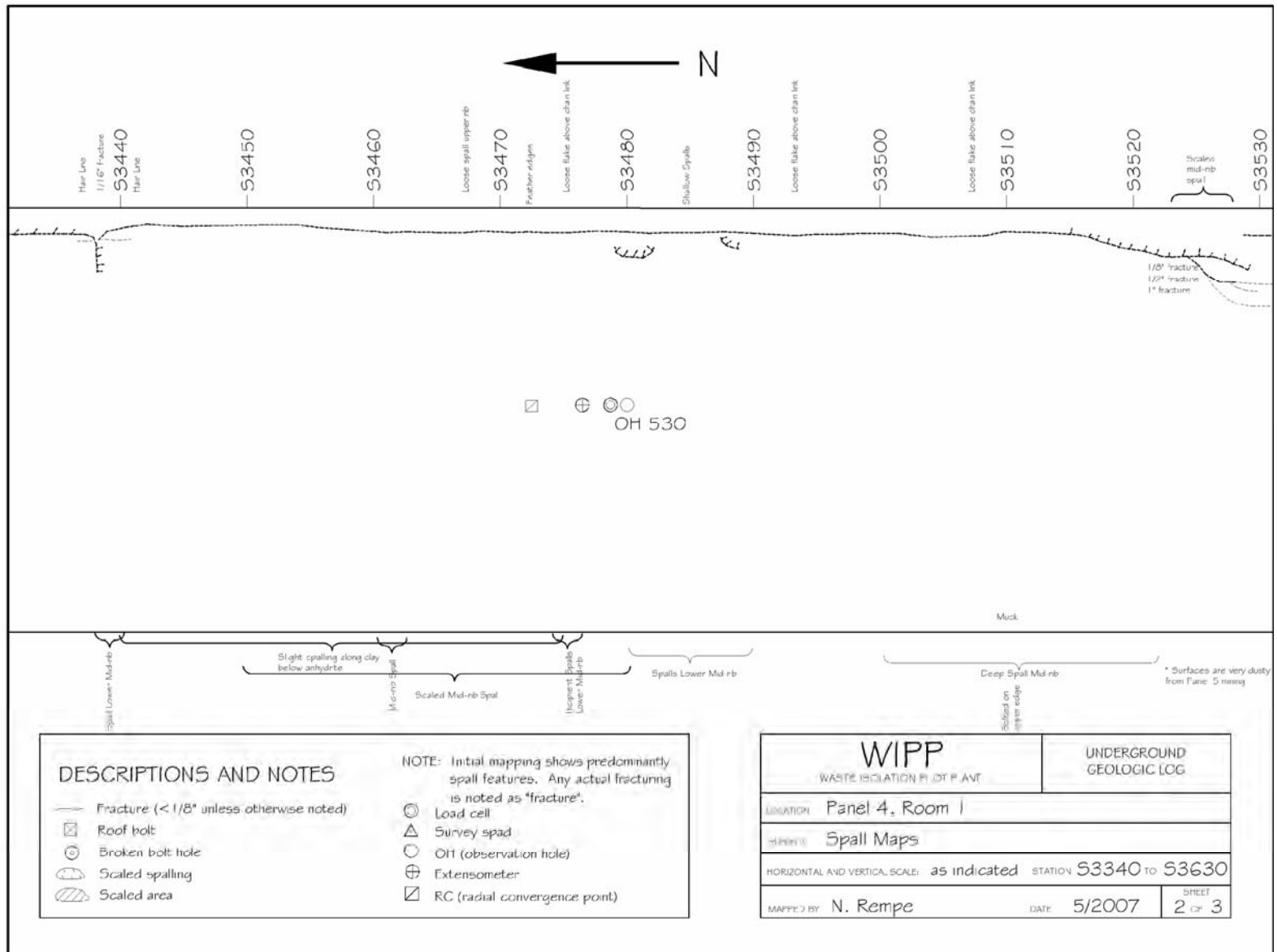


Figure 6-2  
Panel 4 Room 1, S3340 – S3530 Roof Fractures (Sheet 2 of 3)

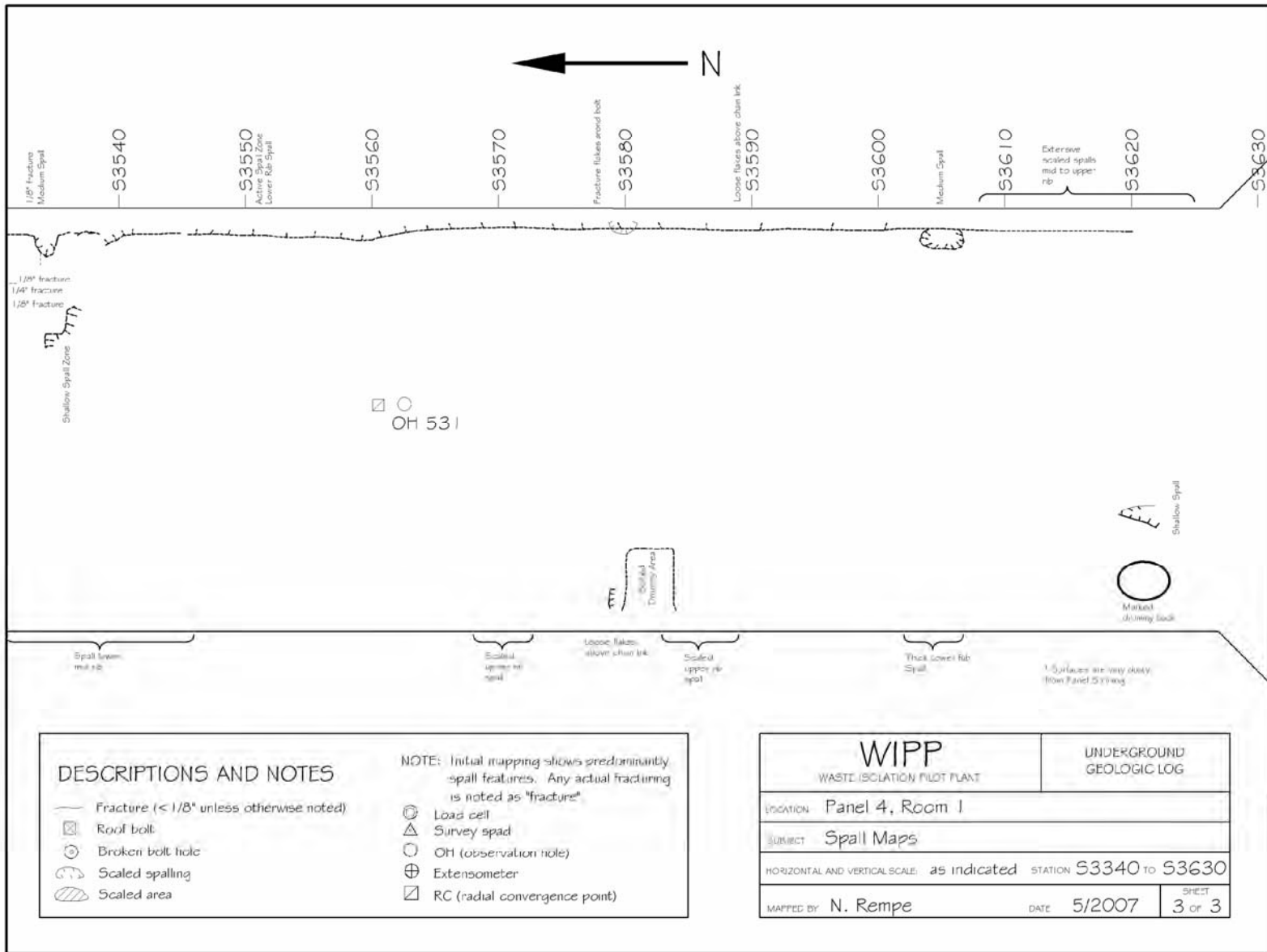


Figure 6-3  
Panel 4 Room 1, S3340 – S3630 Roof Fractures (Sheet 3 of 3)

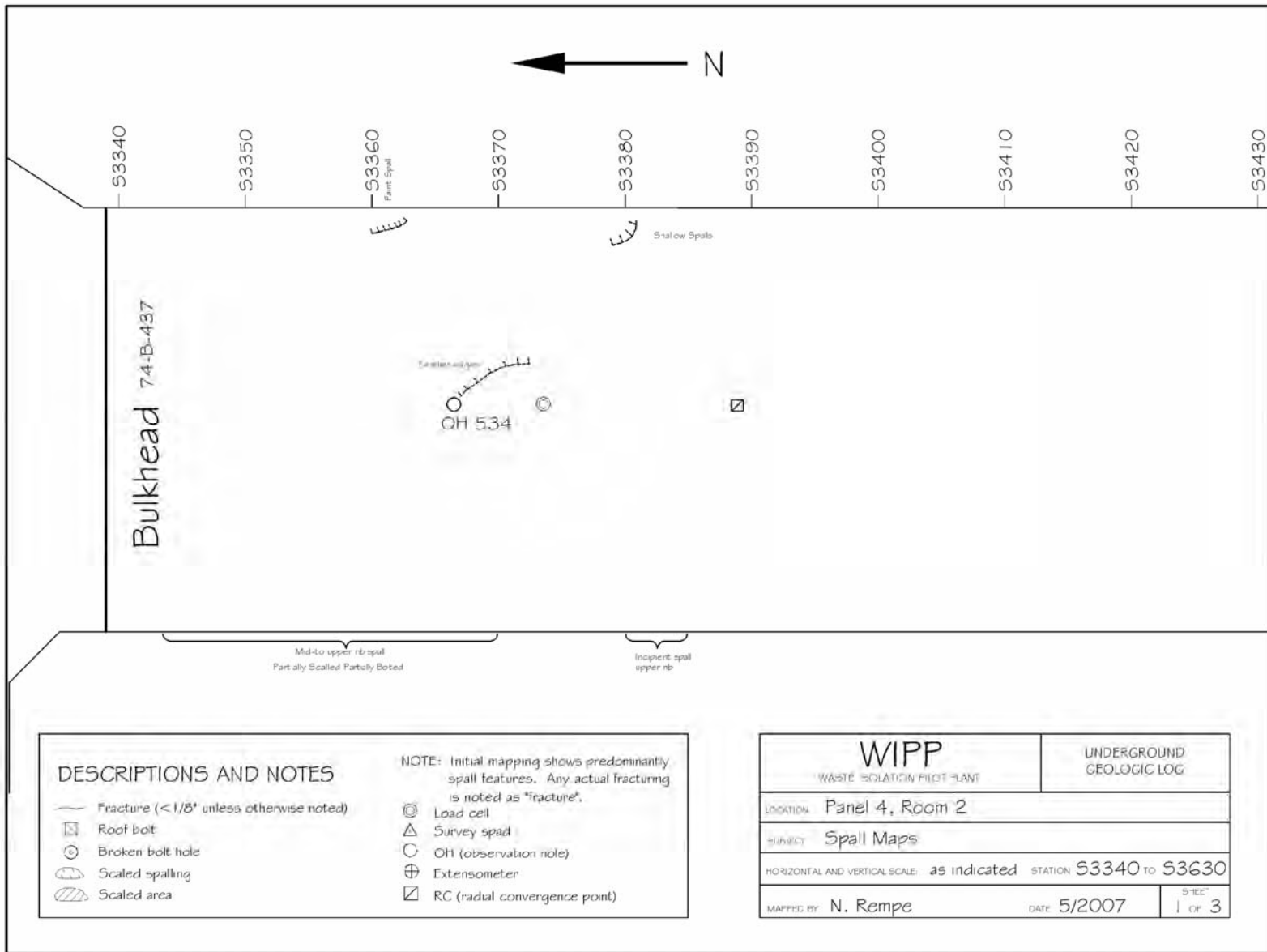


Figure 6-4  
Panel 4 Room 2, S3340 – S3630 Roof Fractures (Sheet 1 of 3)

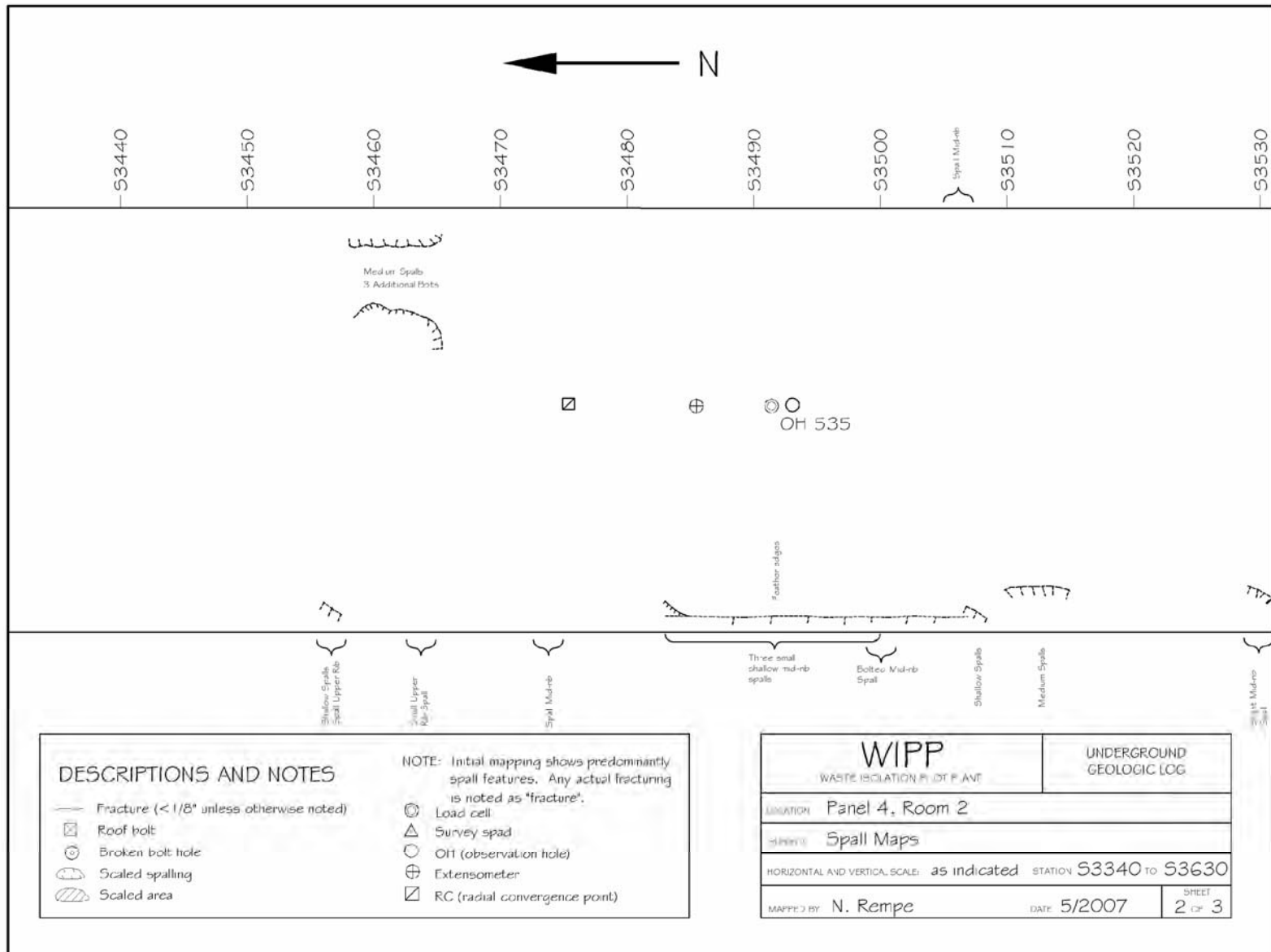


Figure 6-5  
Panel 4 Room 2, S3340 – S3630 Roof Fractures (Sheet 2 of 3)

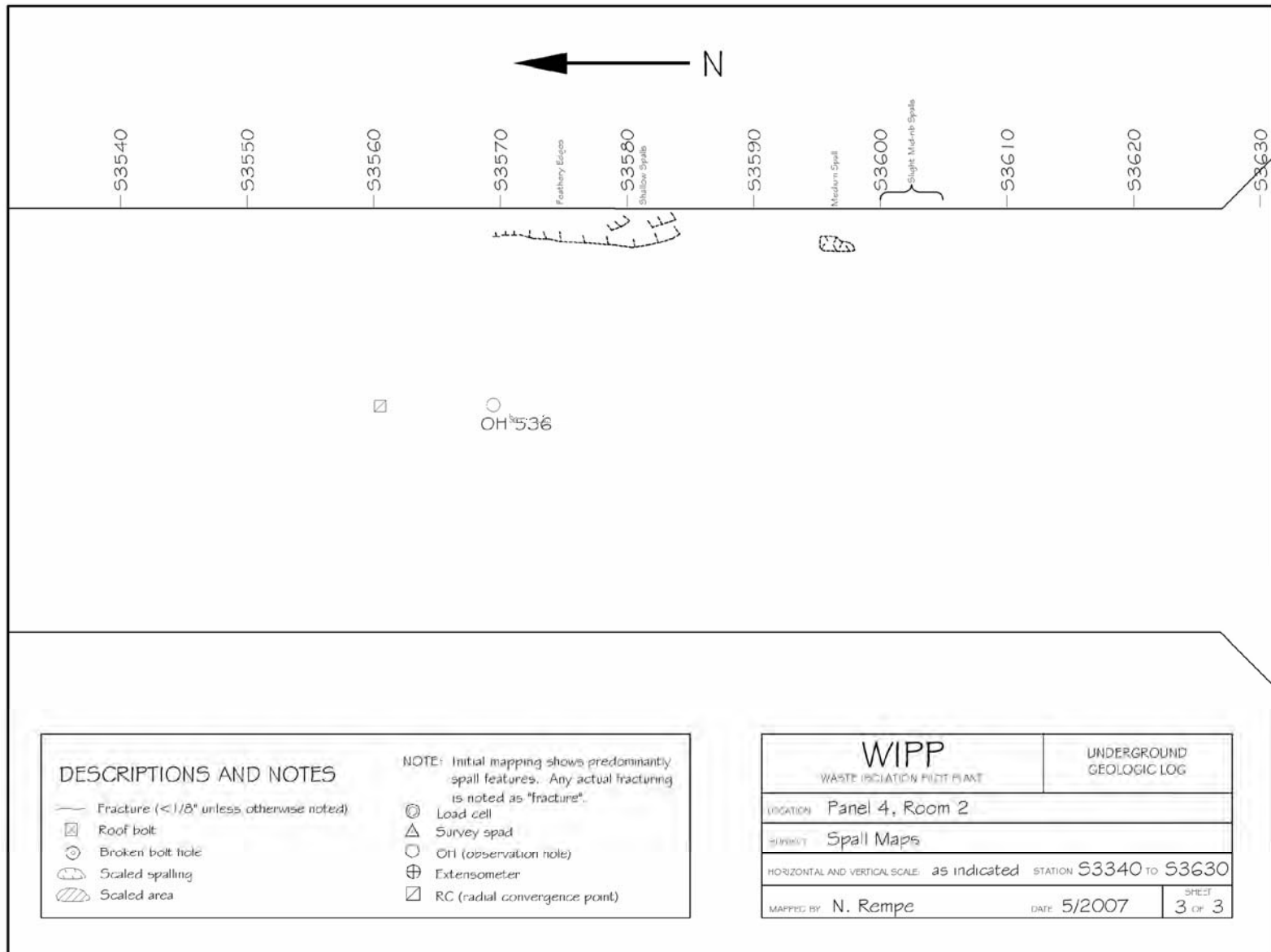


Figure 6-6  
Panel 4 Room 2, S3340 – S3630 Roof Fractures (Sheet 3 of 3)

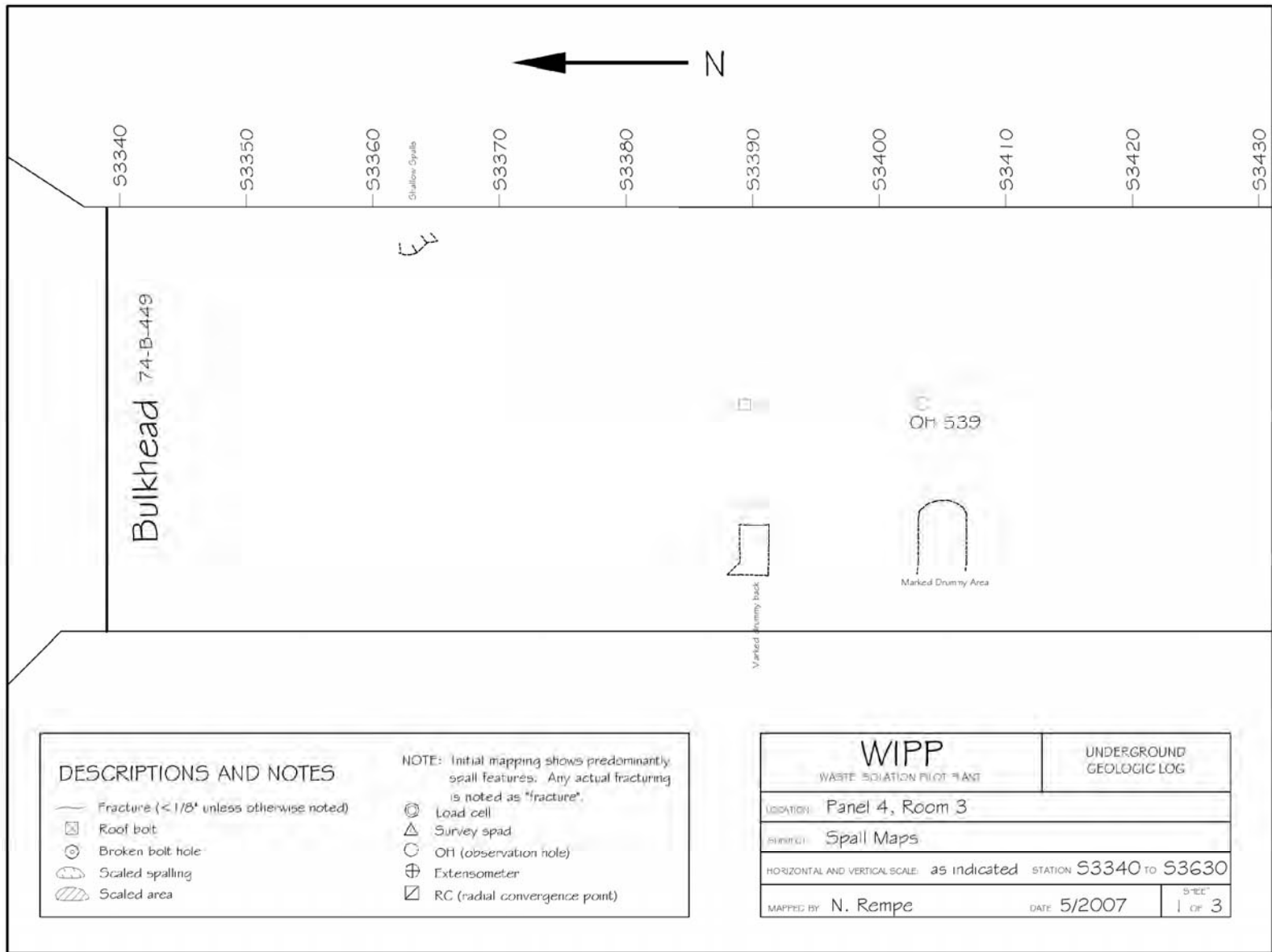


Figure 6-7  
Panel 4 Room 3, S3340 – S3630 Roof Fractures (Sheet 1 of 3)

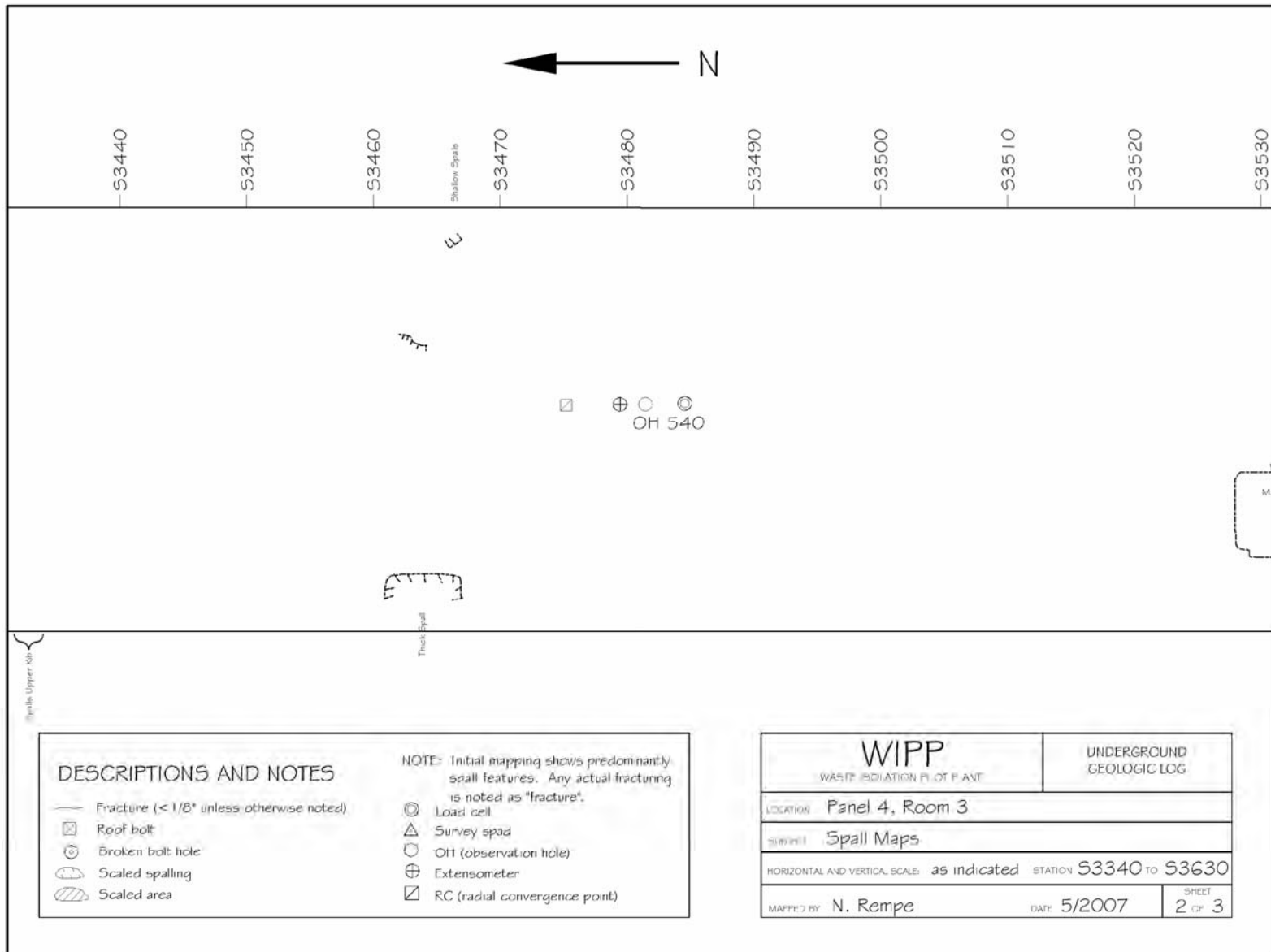


Figure 6-8  
Panel 4 Room 3, S3340 – S3630 Roof Fractures (Sheet 2 of 3)

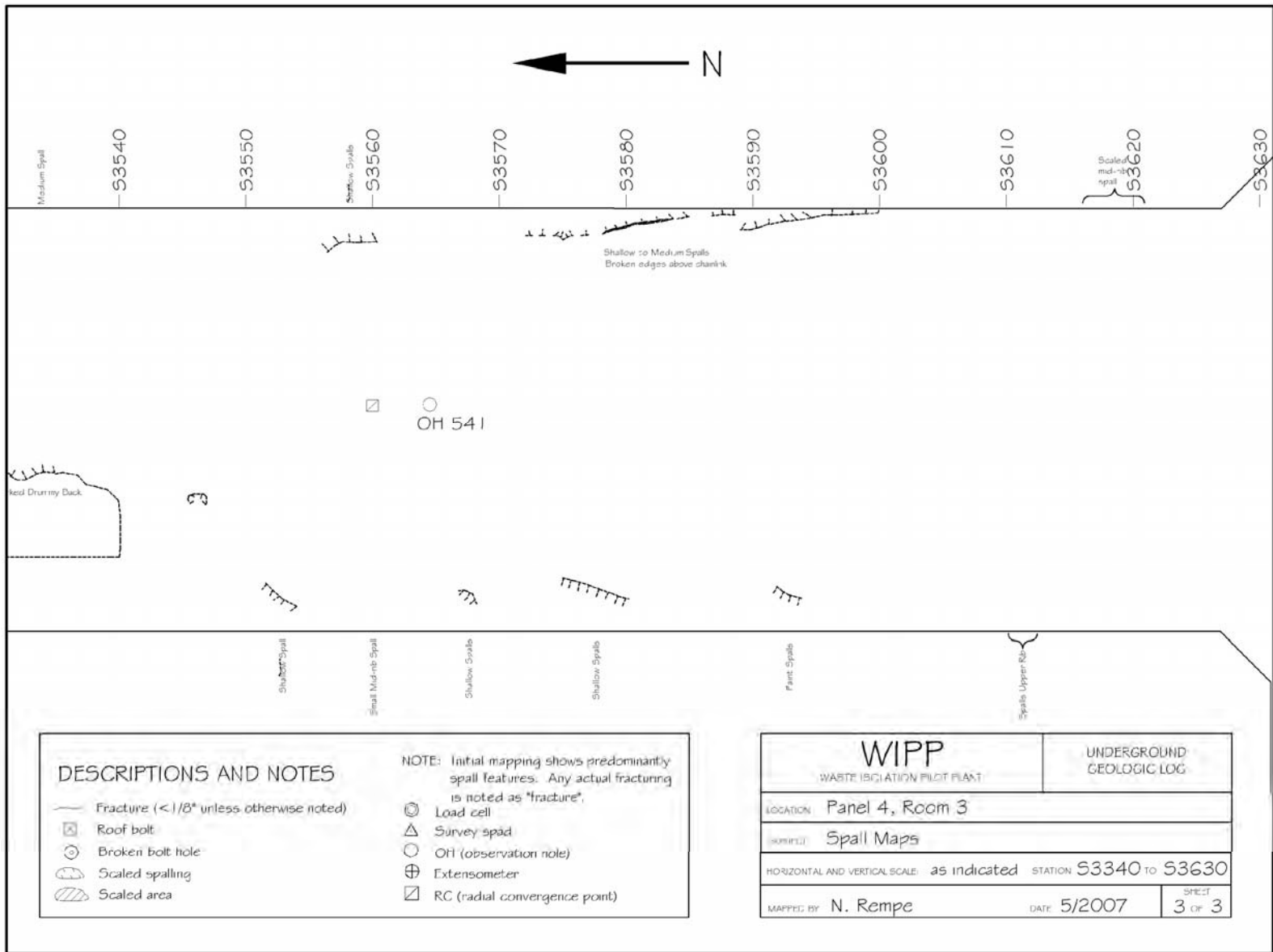


Figure 6-9  
Panel 4 Room 3, S3340 – S3630 Roof Fractures (Sheet 3 of 3)



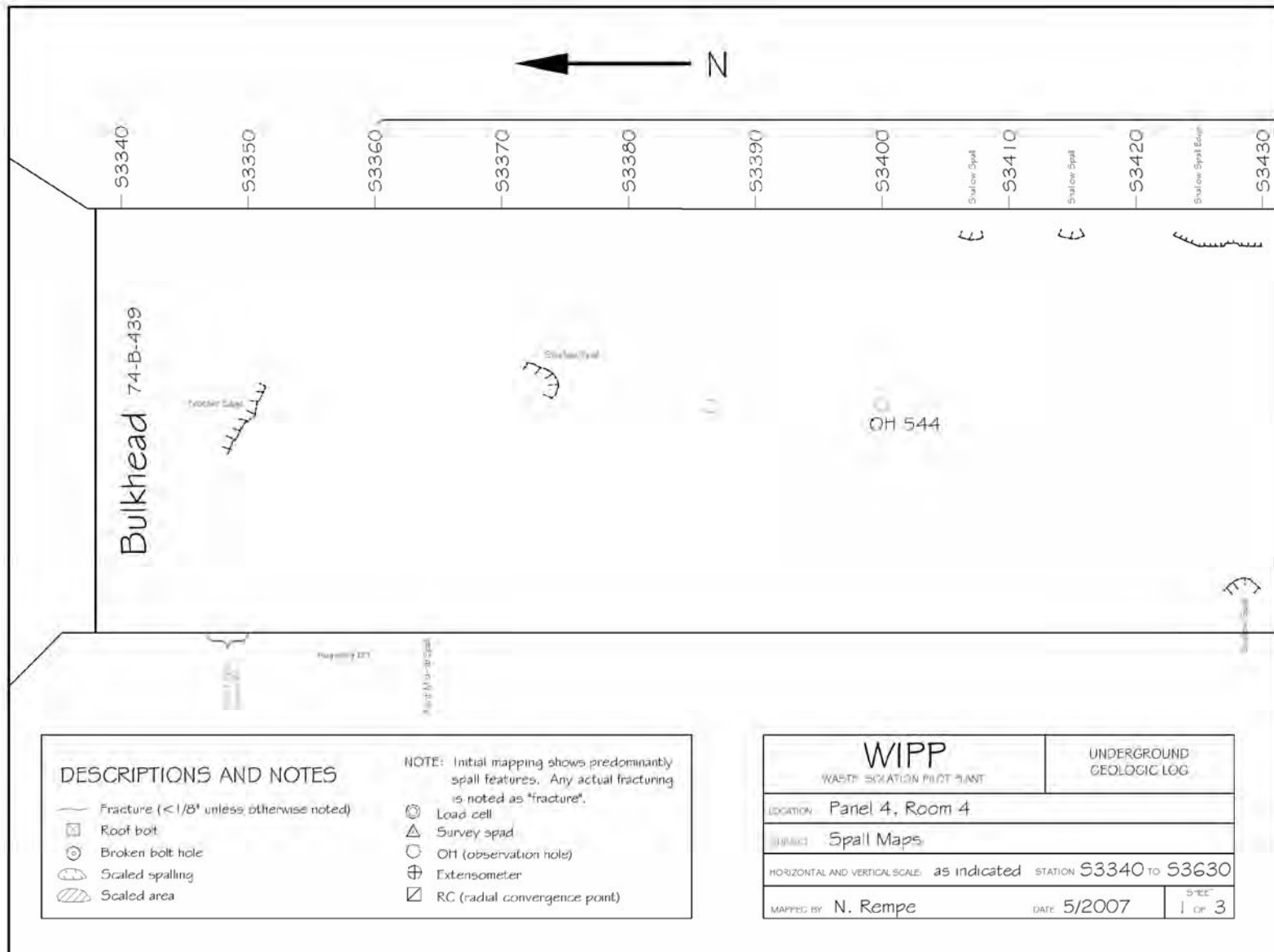


Figure 6-10  
Panel 4 Room 4, S3340 – S3630 Roof Fractures (Sheet 1 of 3)

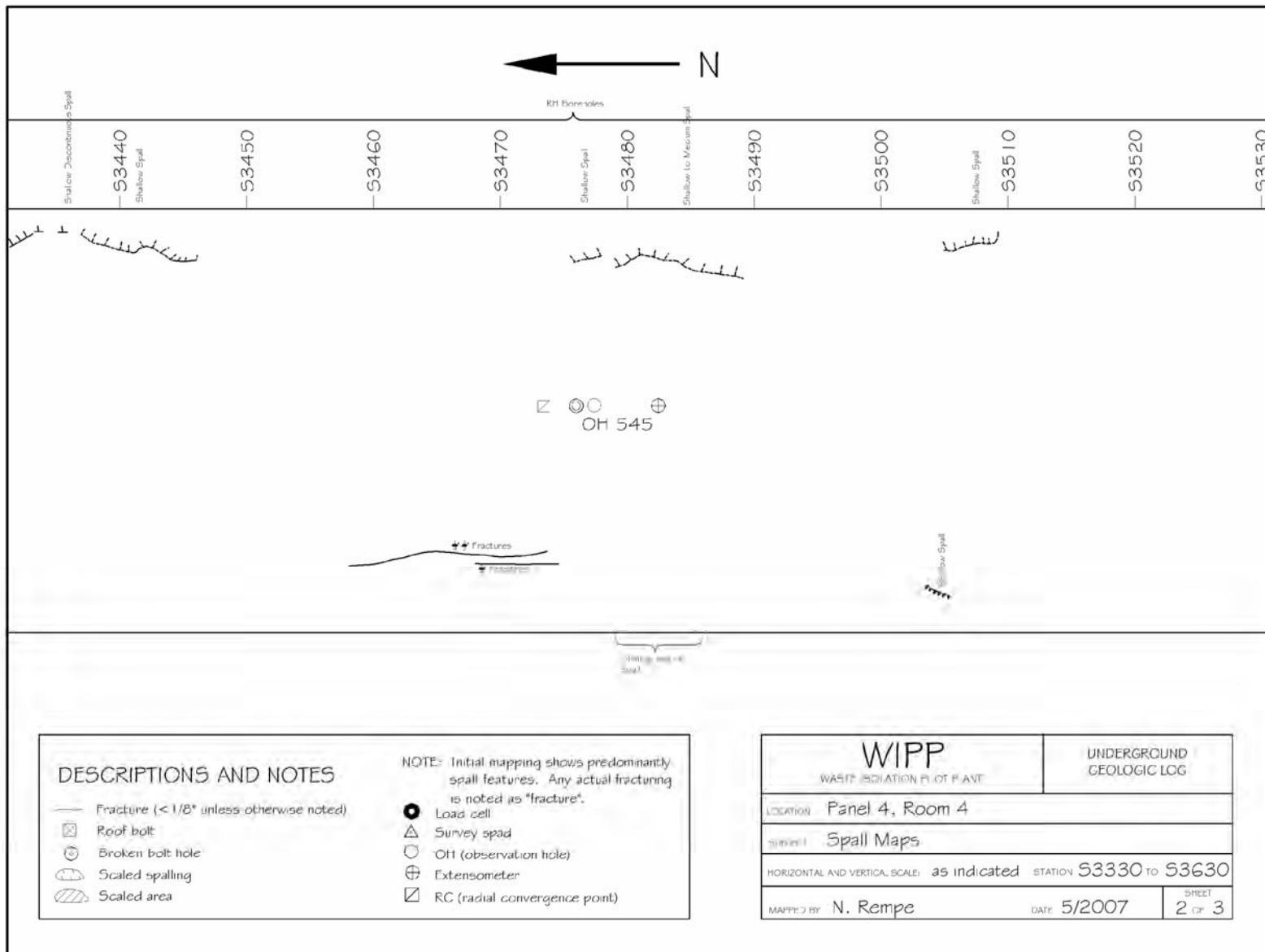
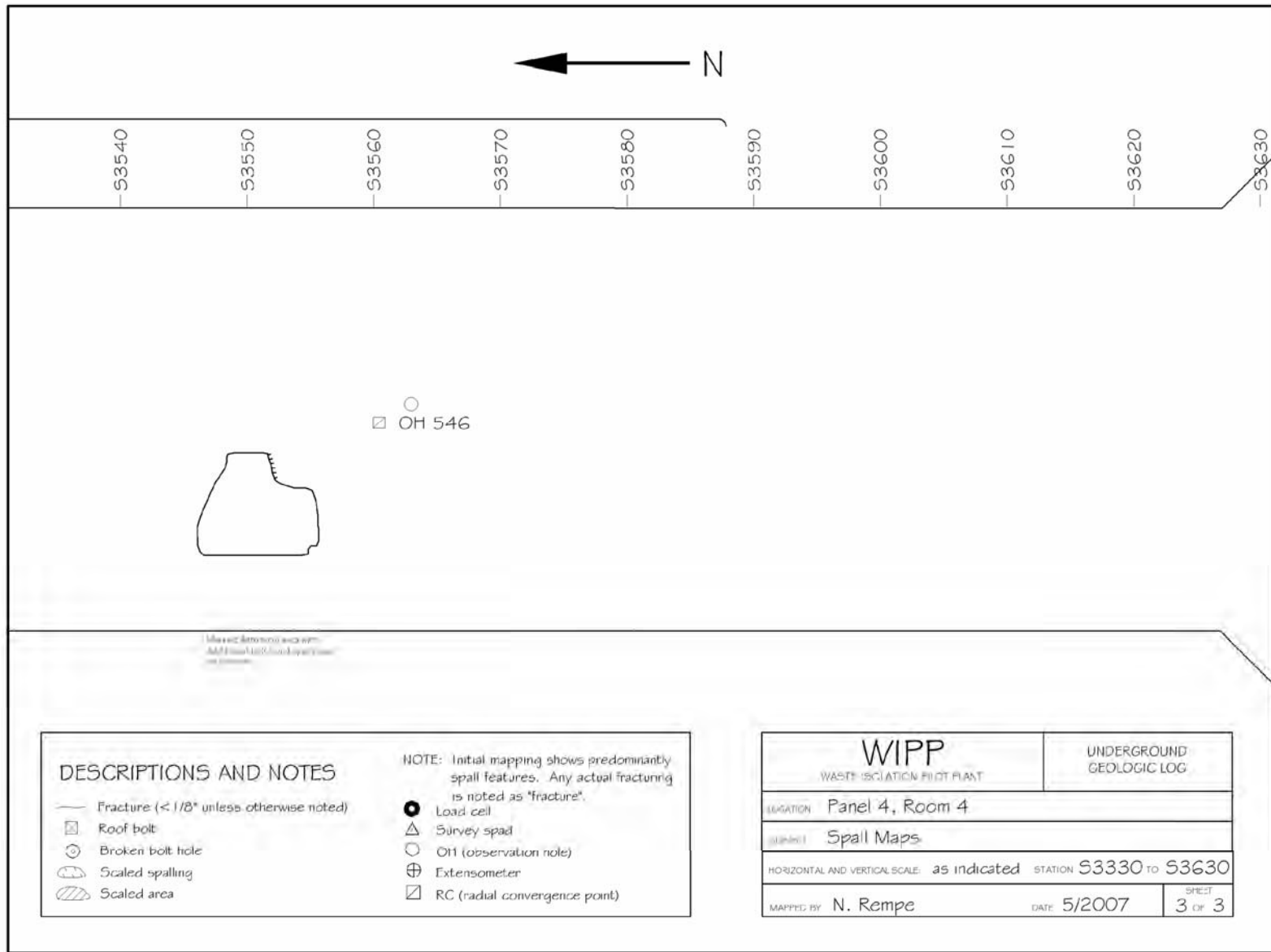


Figure 6-11  
Panel 4 Room 3, S3340 – S3630 Roof Fractures (Sheet 2 of 3)



**Figure 6-12**  
Panel 4 Room 4, S3340 – S3630 Roof Fractures (Sheet 3 of 3)

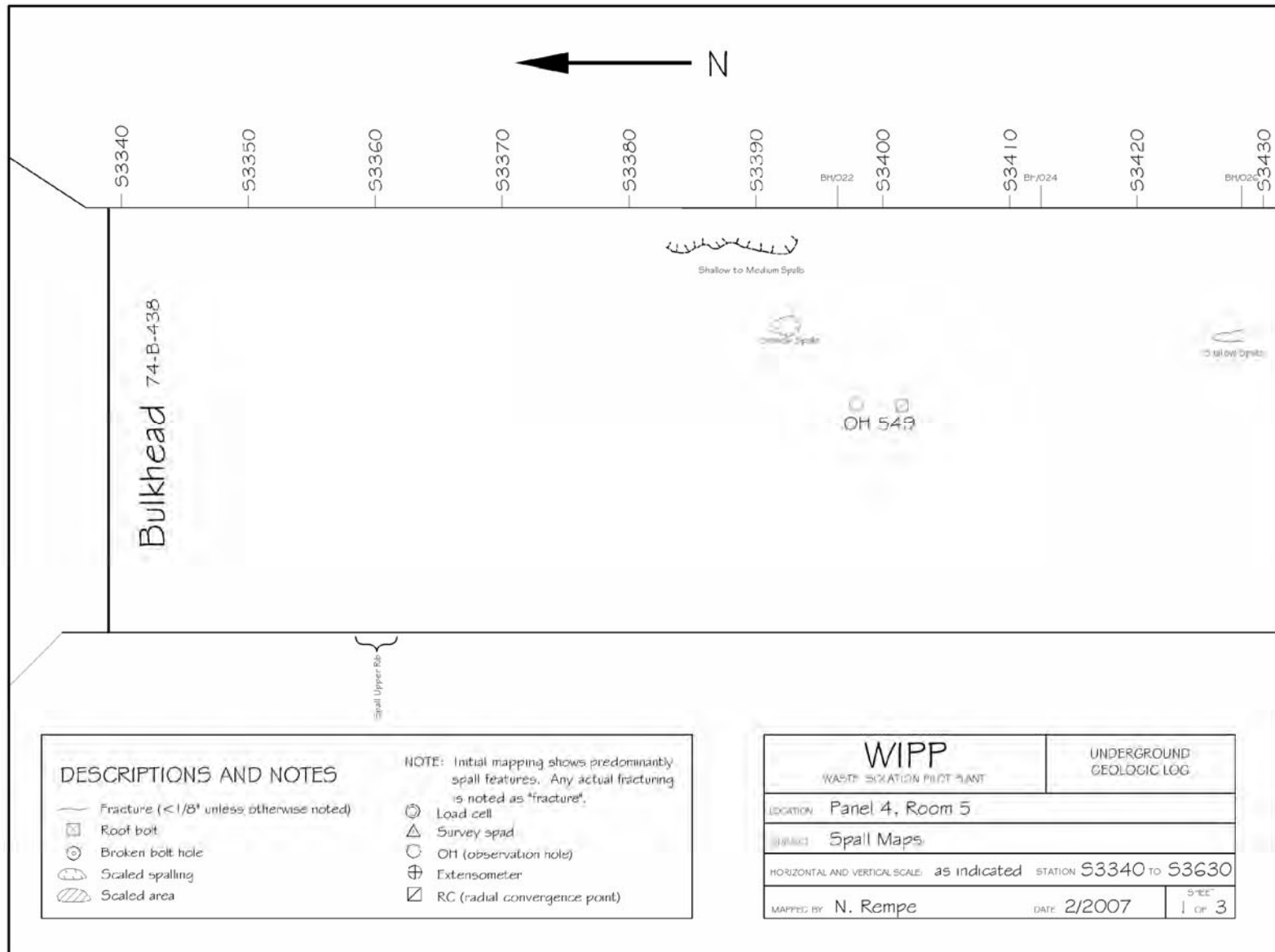


Figure 6-13  
Panel 4 Room 5, S3340 – S3630 Roof Fractures (Sheet 1 of 3)

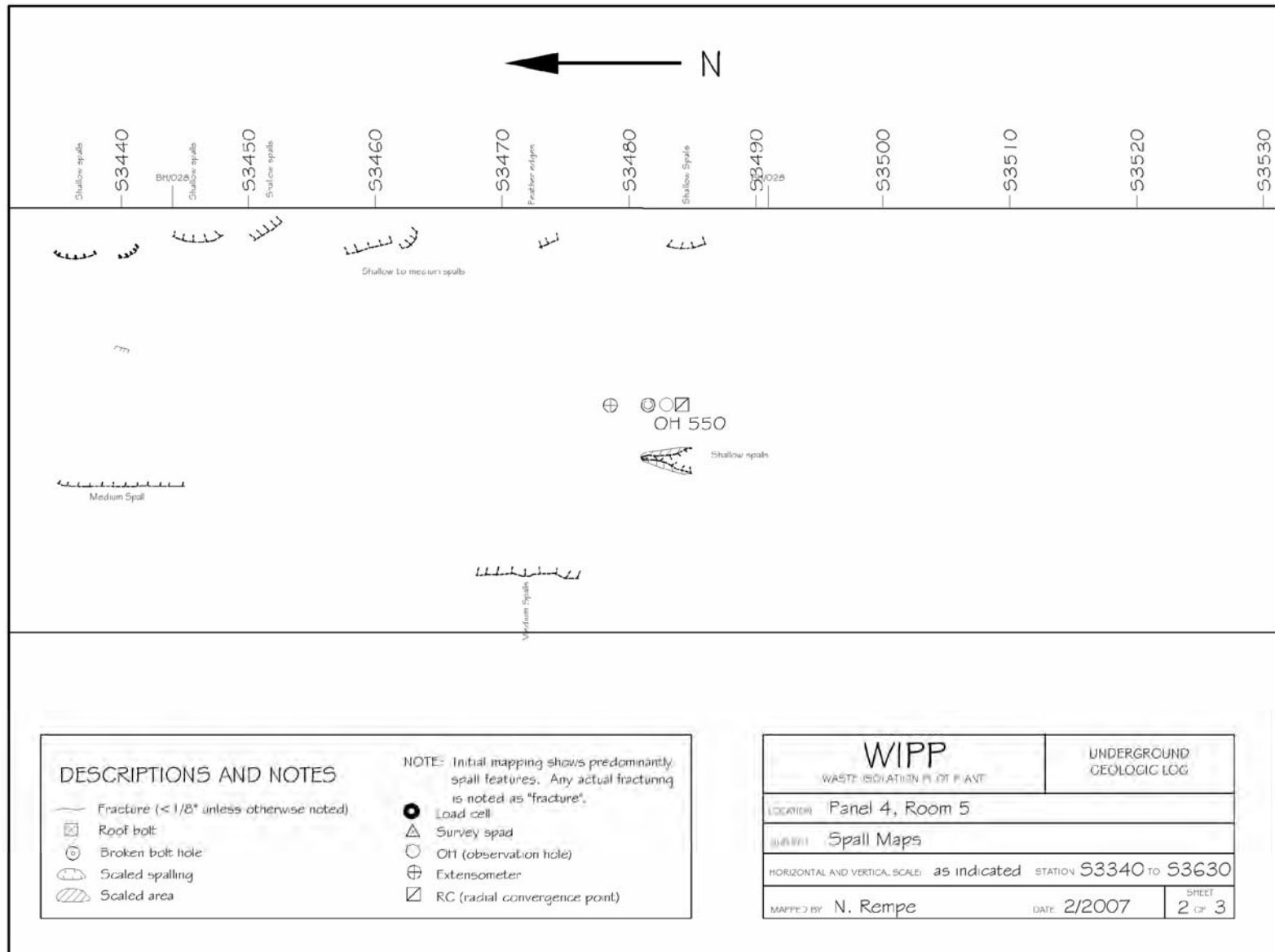
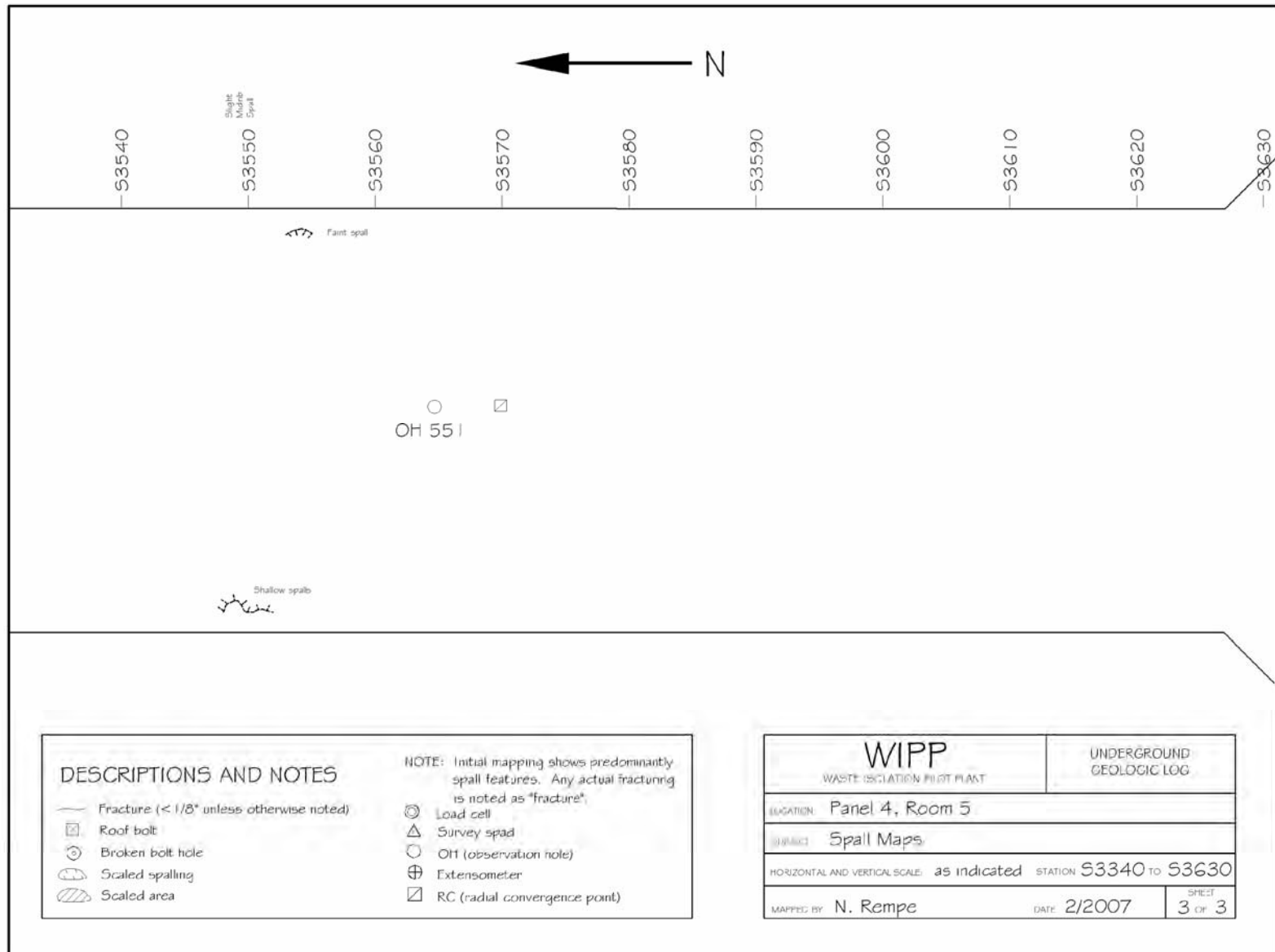
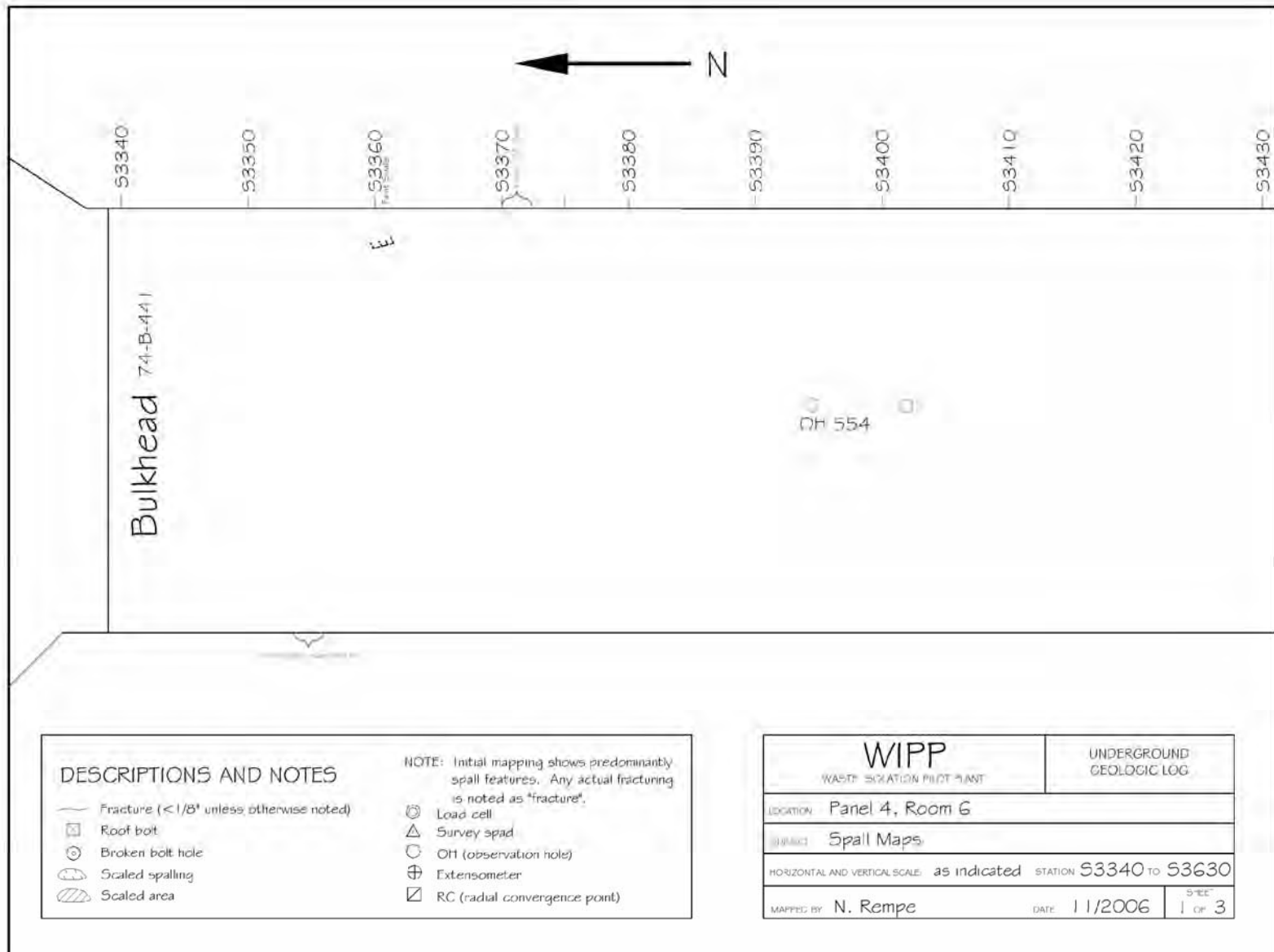


Figure 6-14  
Panel 4 Room 5, S3340 – S3630 Roof Fractures (Sheet 2 of 3)



**Figure 6-15**  
Panel 4 Room 5, S3340 – S3630 Roof Fractures (Sheet 3 of 3)



**Figure 6-16**  
Panel 4 Room 6, S3340 – S3630 Roof Fractures (Sheet 1 of 3)

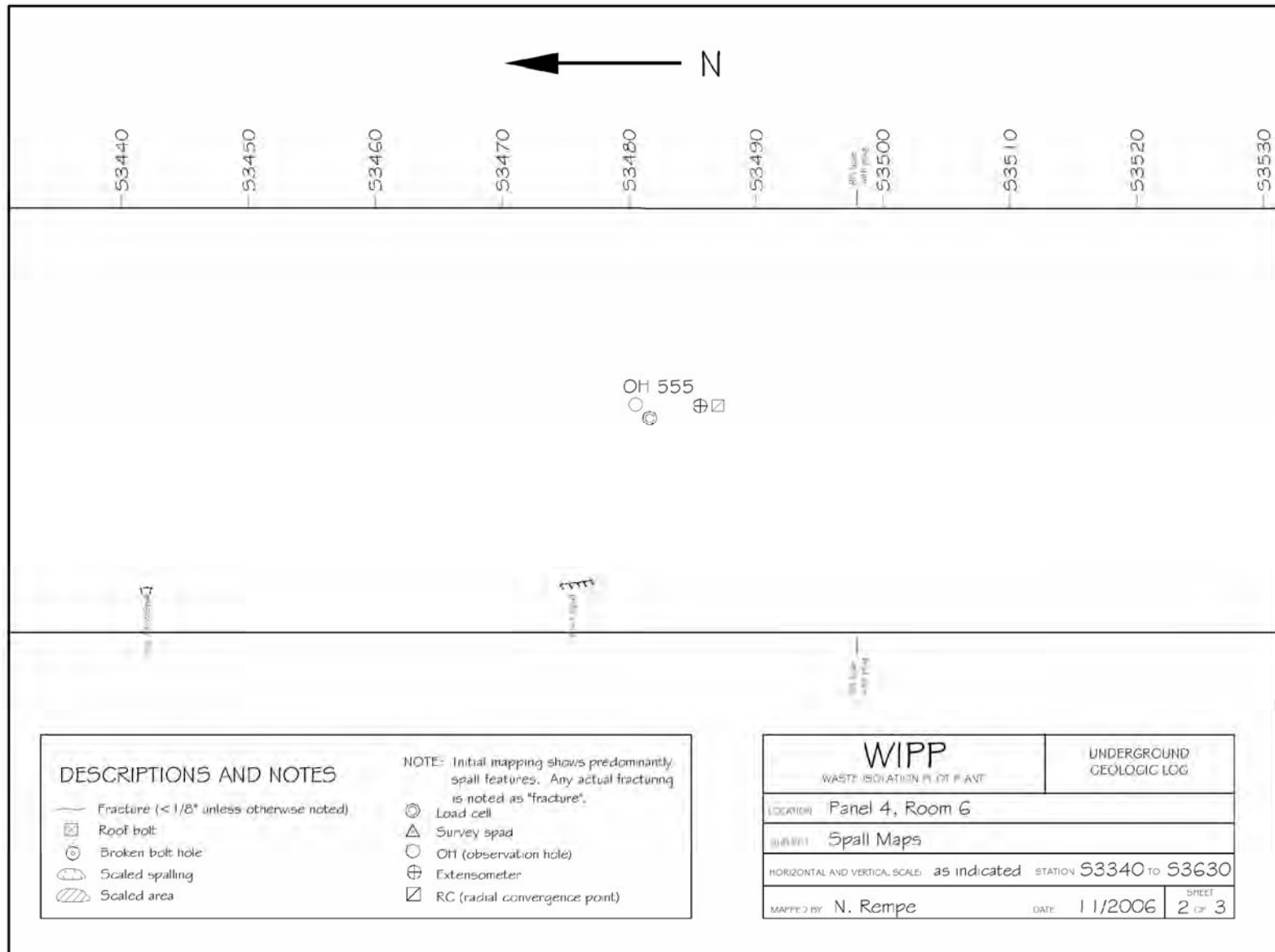
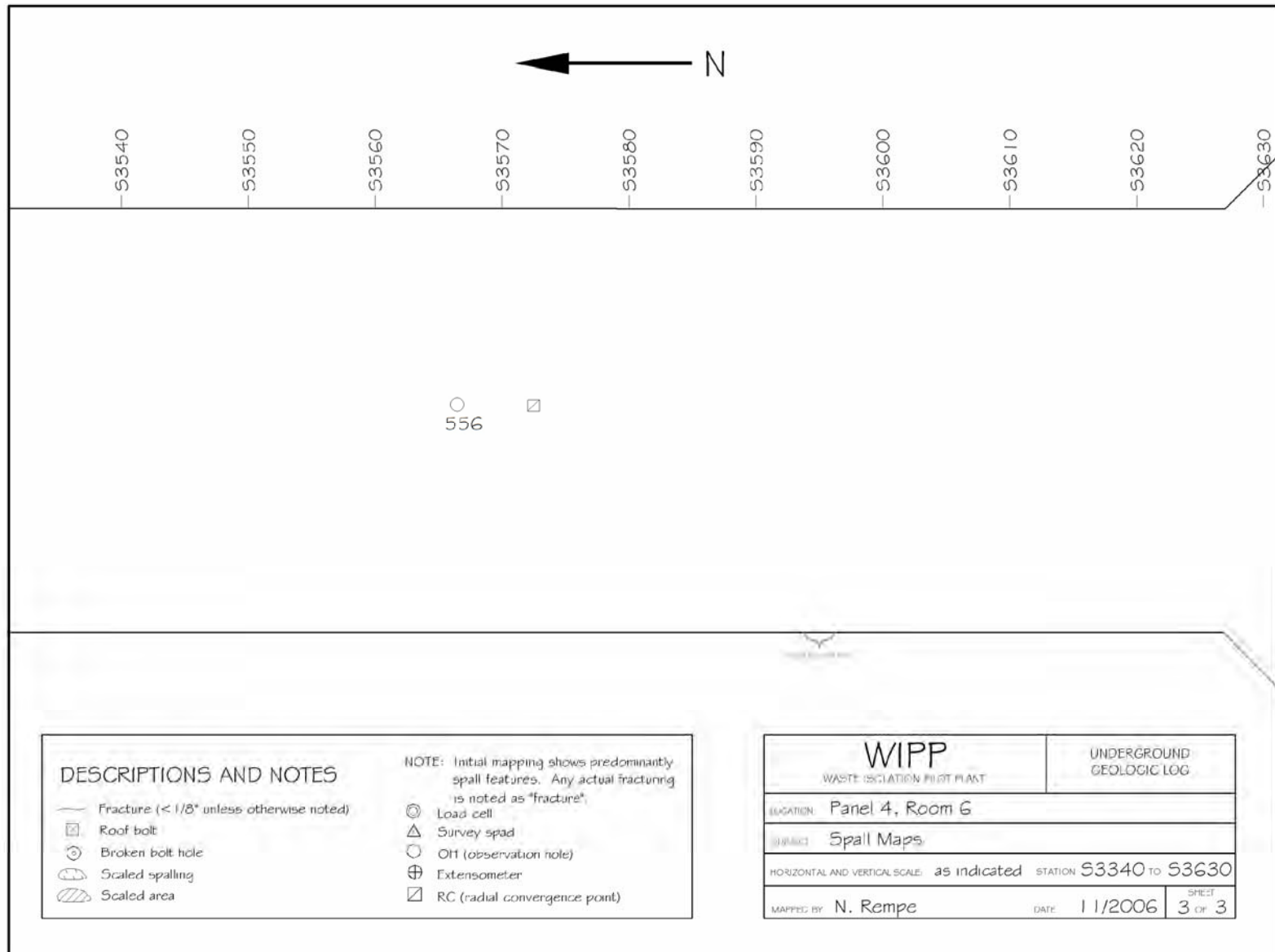
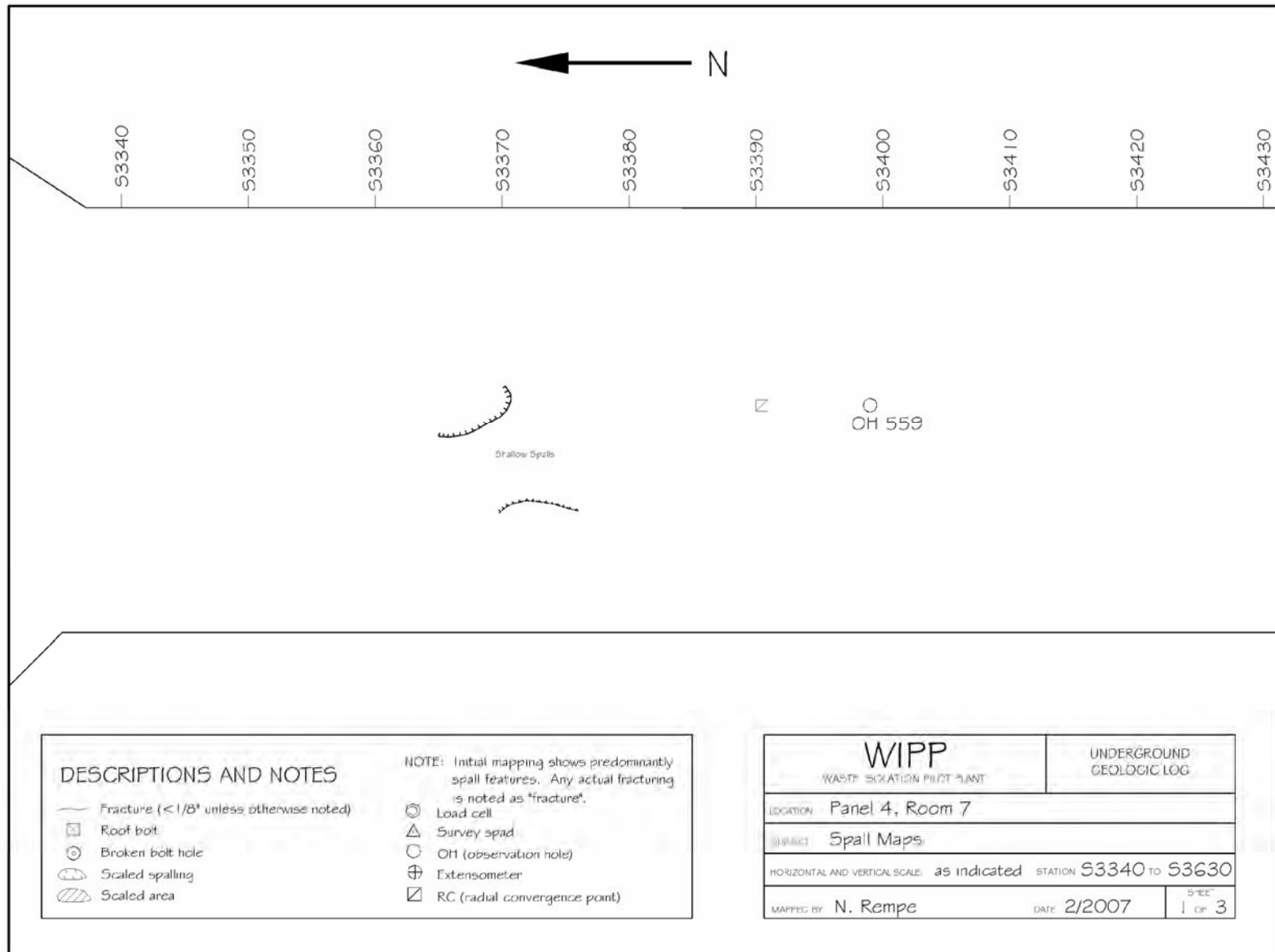


Figure 6-17  
Panel 4 Room 6, S3340 – S3630 Roof Fractures (Sheet 2 of 3)





**Figure 6-18**  
Panel 4 Room 6, S3340 – S3630 Roof Fractures (Sheet 3 of 3)



**Figure 6-19**  
Panel 4 Room 7, S3340 – S3630 Roof Fractures (Sheet 1 of 3)

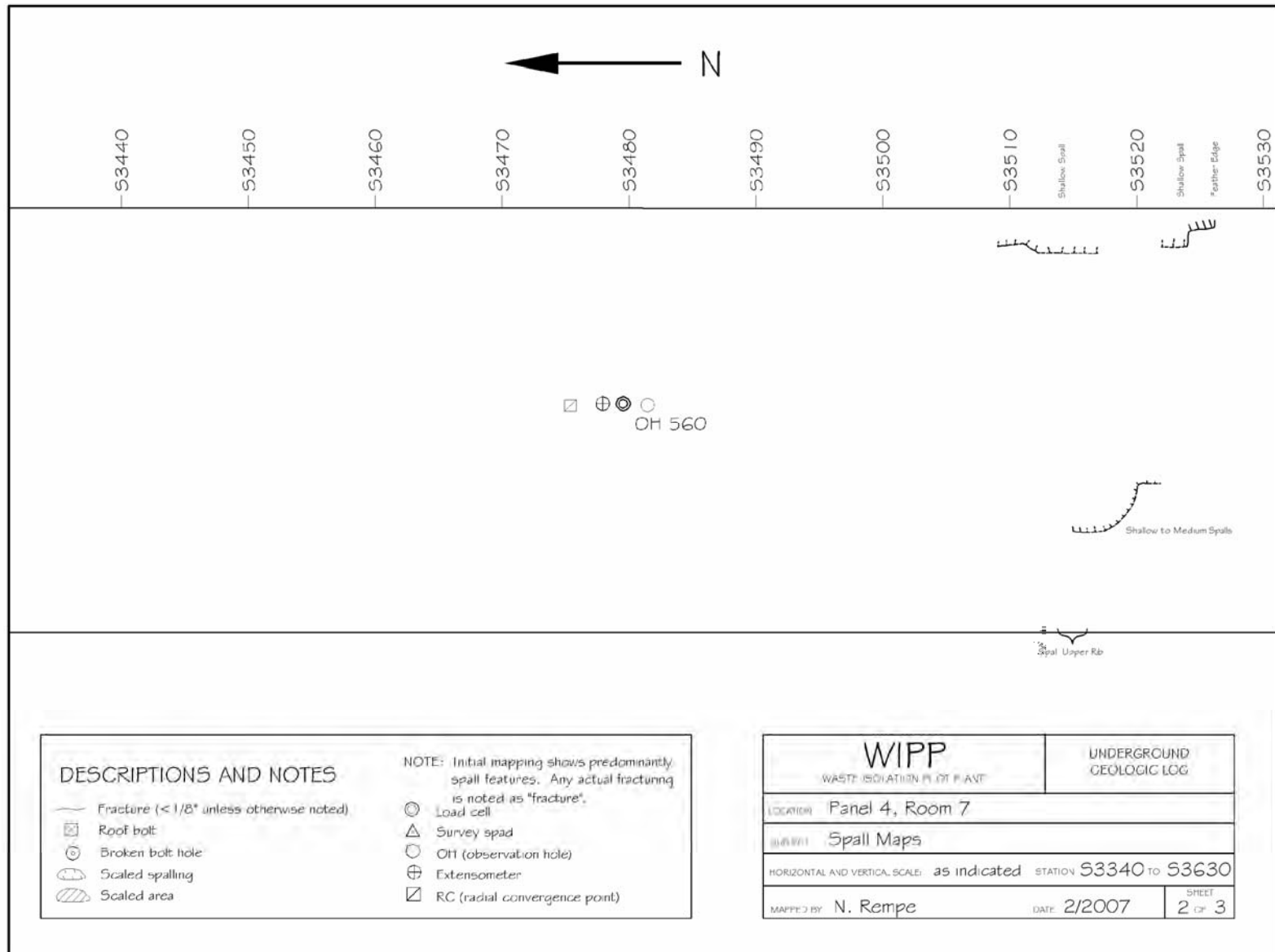


Figure 6-20  
Panel 4 Room 7, S3340 – S3630 Roof Fractures (Sheet 2 of 3)

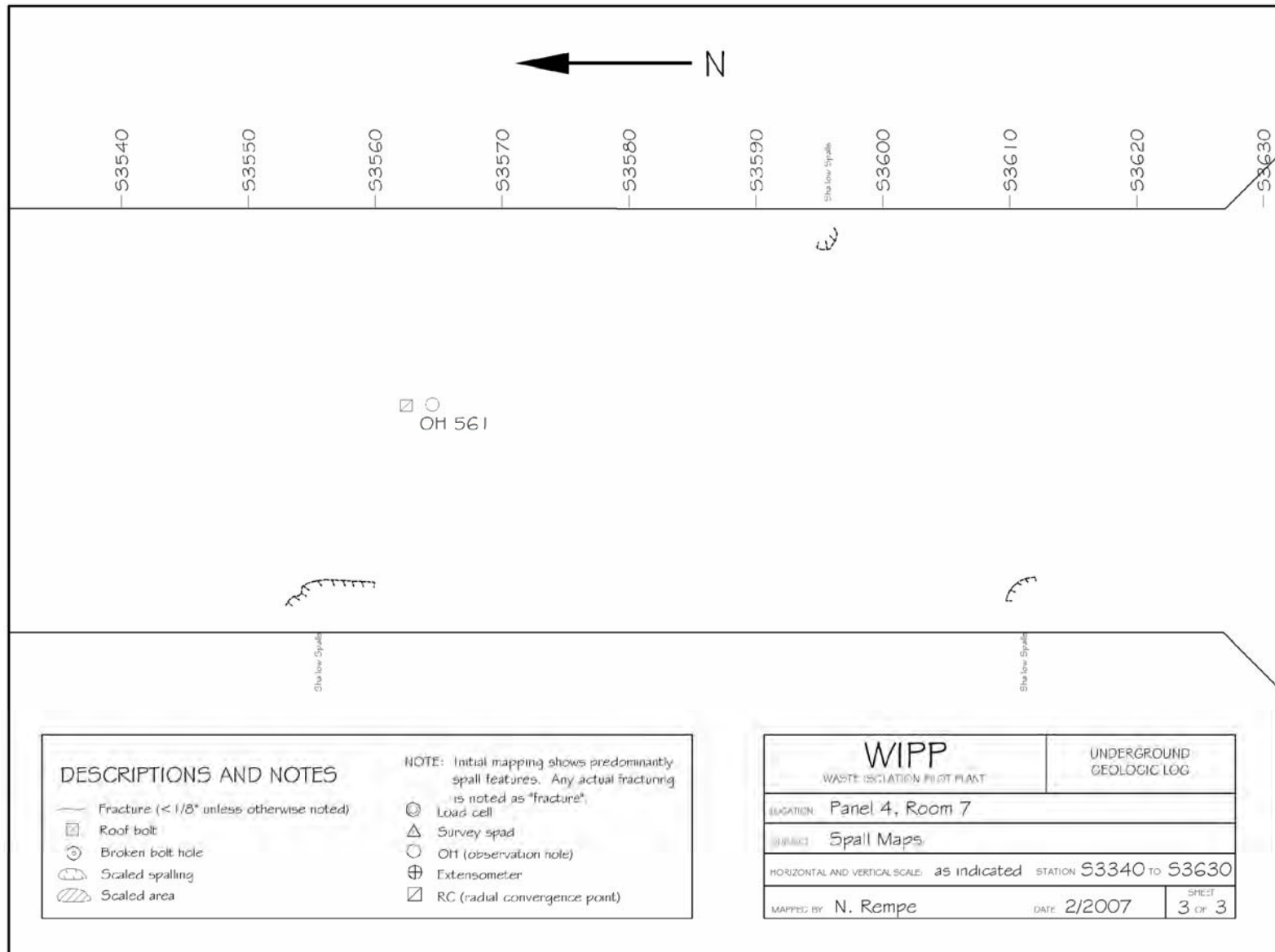


Figure 6-21  
Panel 4 Room 7, S3340 – S3630 Roof Fractures (Sheet 3 of 3)

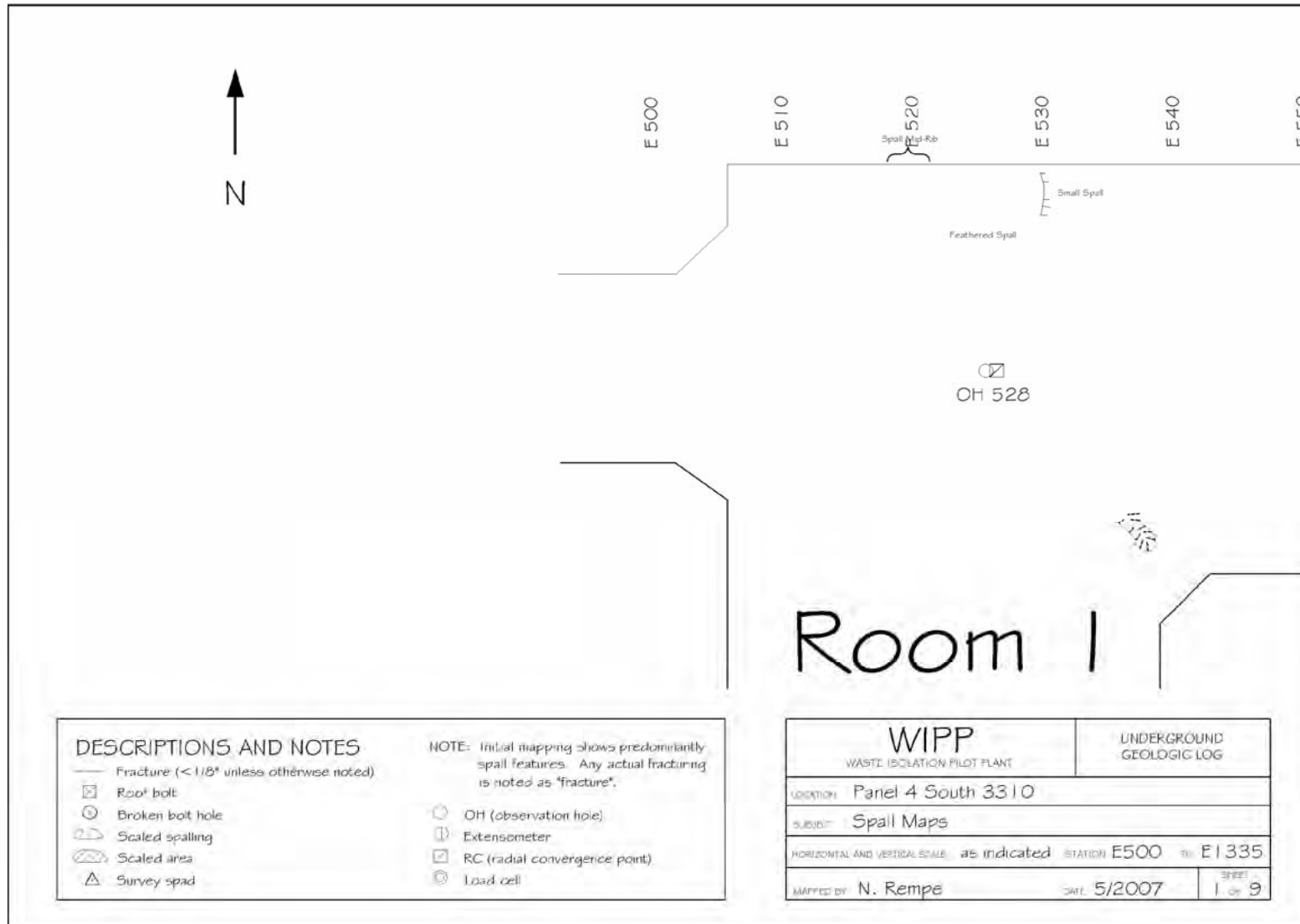


Figure 6-22  
Panel 4 S3310, E500 – E1335 Roof Fractures (Sheet 1 of 9)

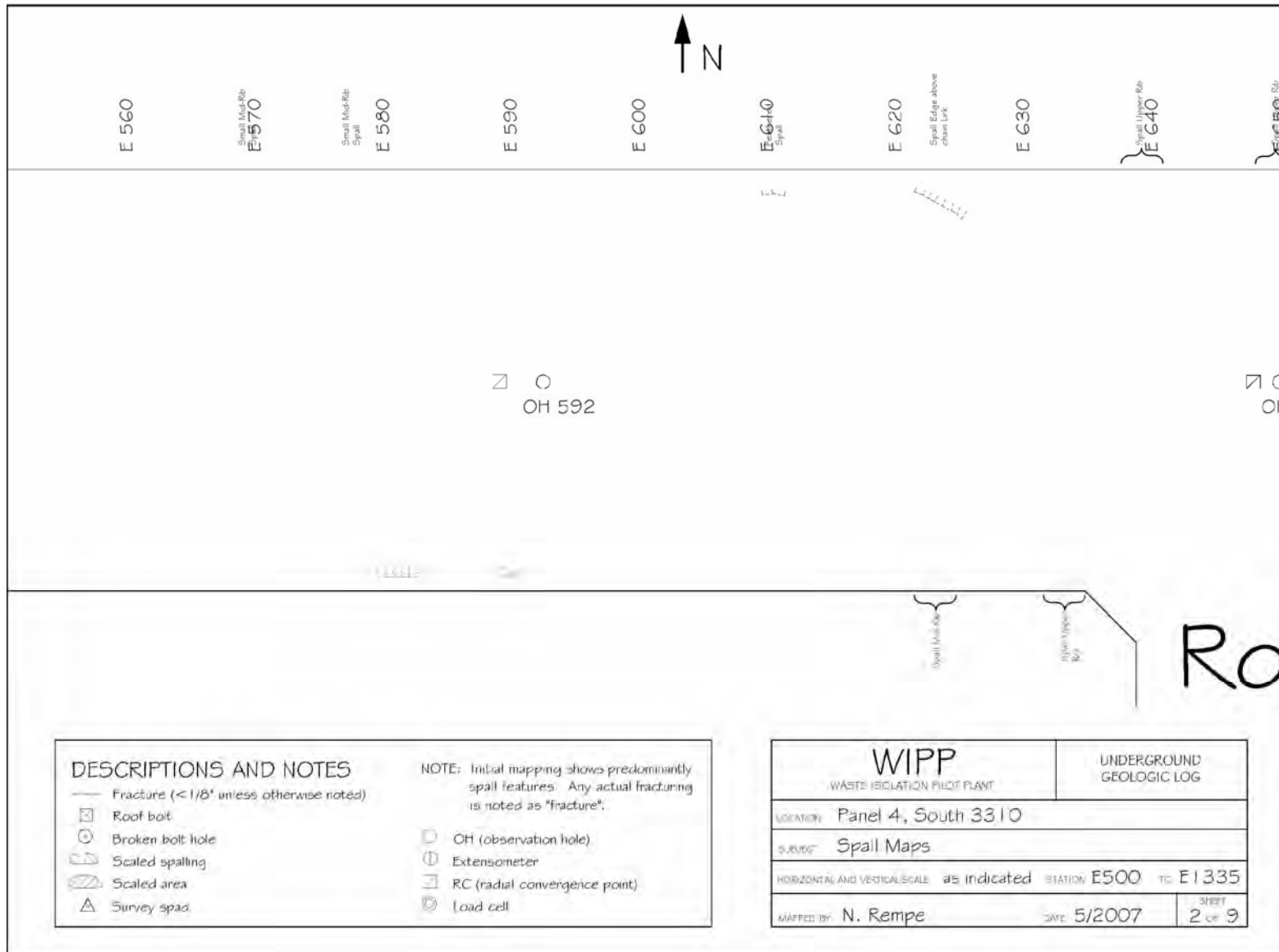


Figure 6-23  
Panel 4 S3310, E500 – E1335 Roof Fractures (Sheet 2 of 9)

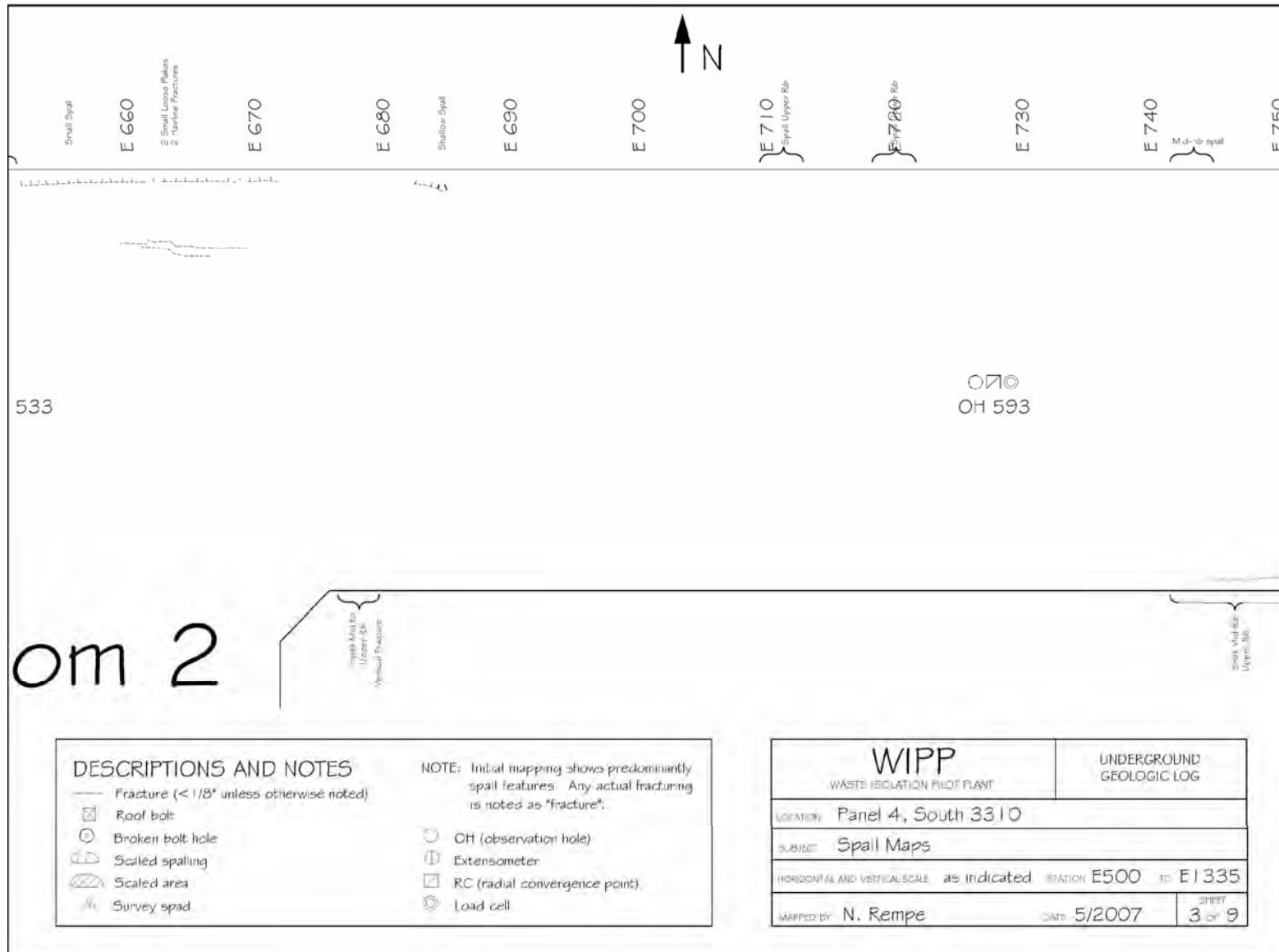


Figure 6-24  
Panel 4 S3310, E500 – E1335 Roof Fractures (Sheet 3 of 9)

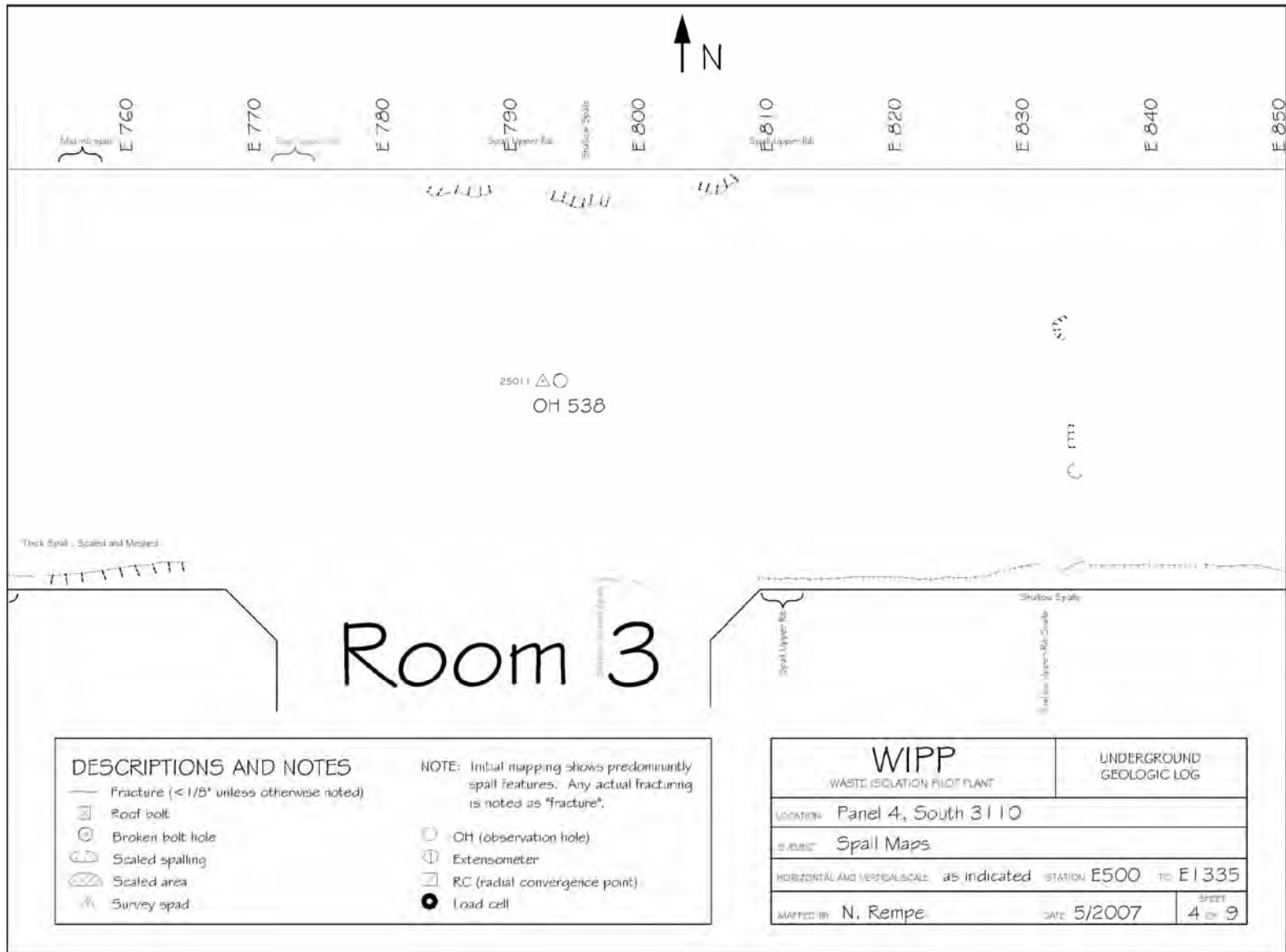


Figure 6-25  
Panel 4 S3310, E500 – E1335 Roof Fractures (Sheet 4 of 9)



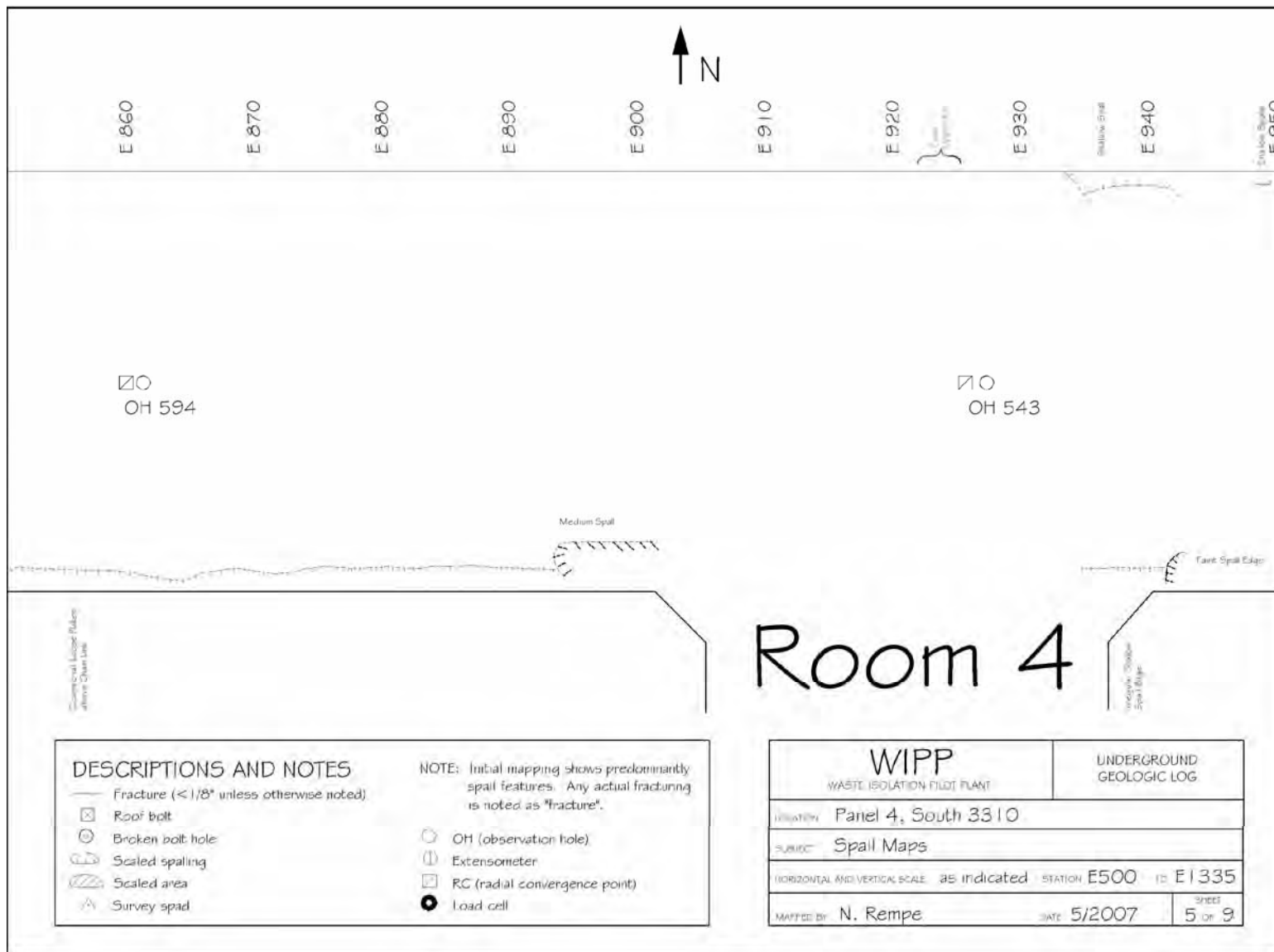


Figure 6-26  
Panel 4 S3310, E500 – E1335 Roof Fractures (Sheet 5 of 9)

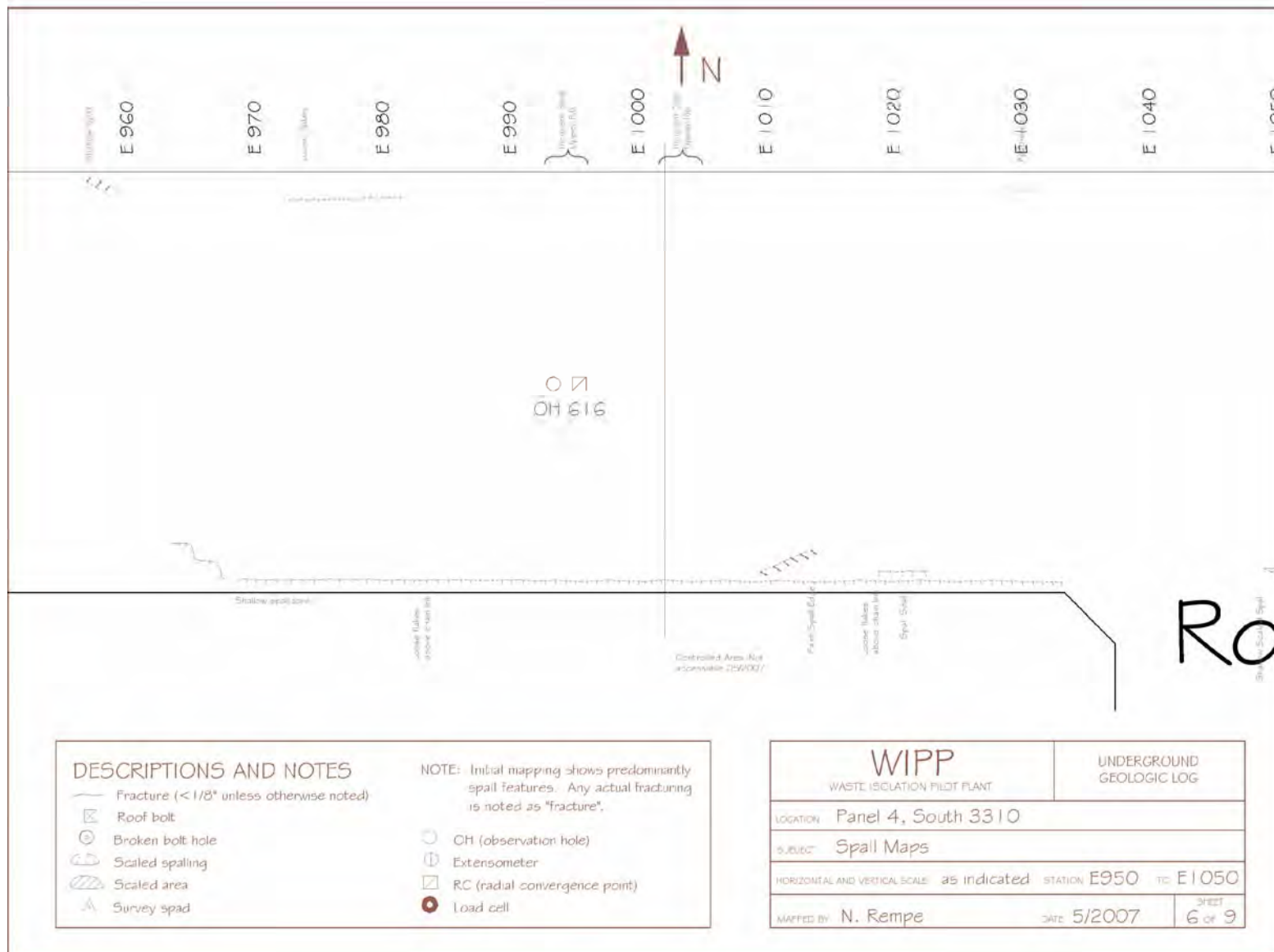


Figure 6-27  
Panel 4 S3310, E500 – E1335 Roof Fractures (Sheet 6 of 9)

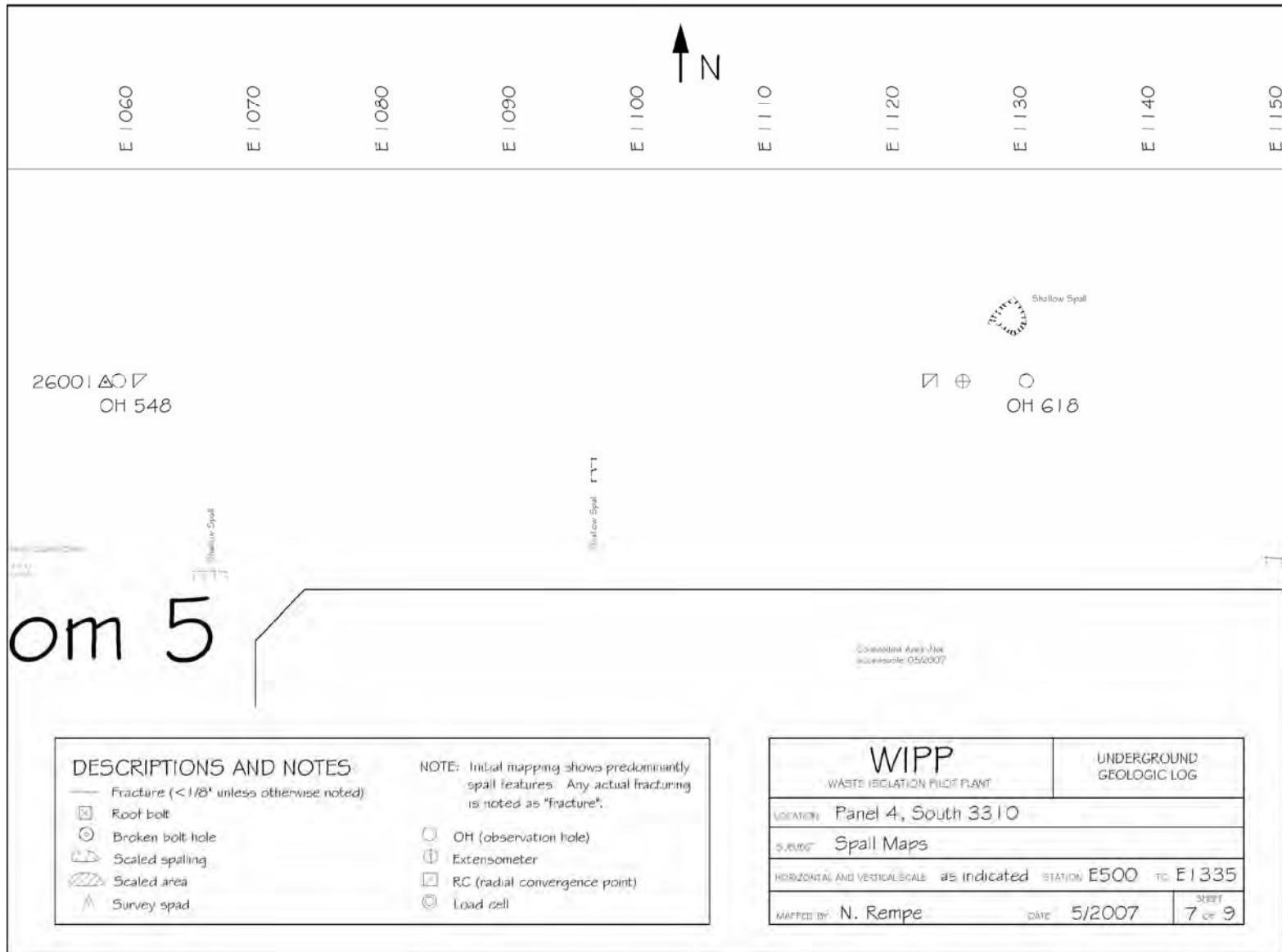


Figure 6-28  
Panel 4 S3310, E500 – E1335 Roof Fractures (Sheet 7 of 9)



Figure 6-29  
Panel 4 S3310, E500 – E1335 Roof Fractures (Sheet 8 of 9)

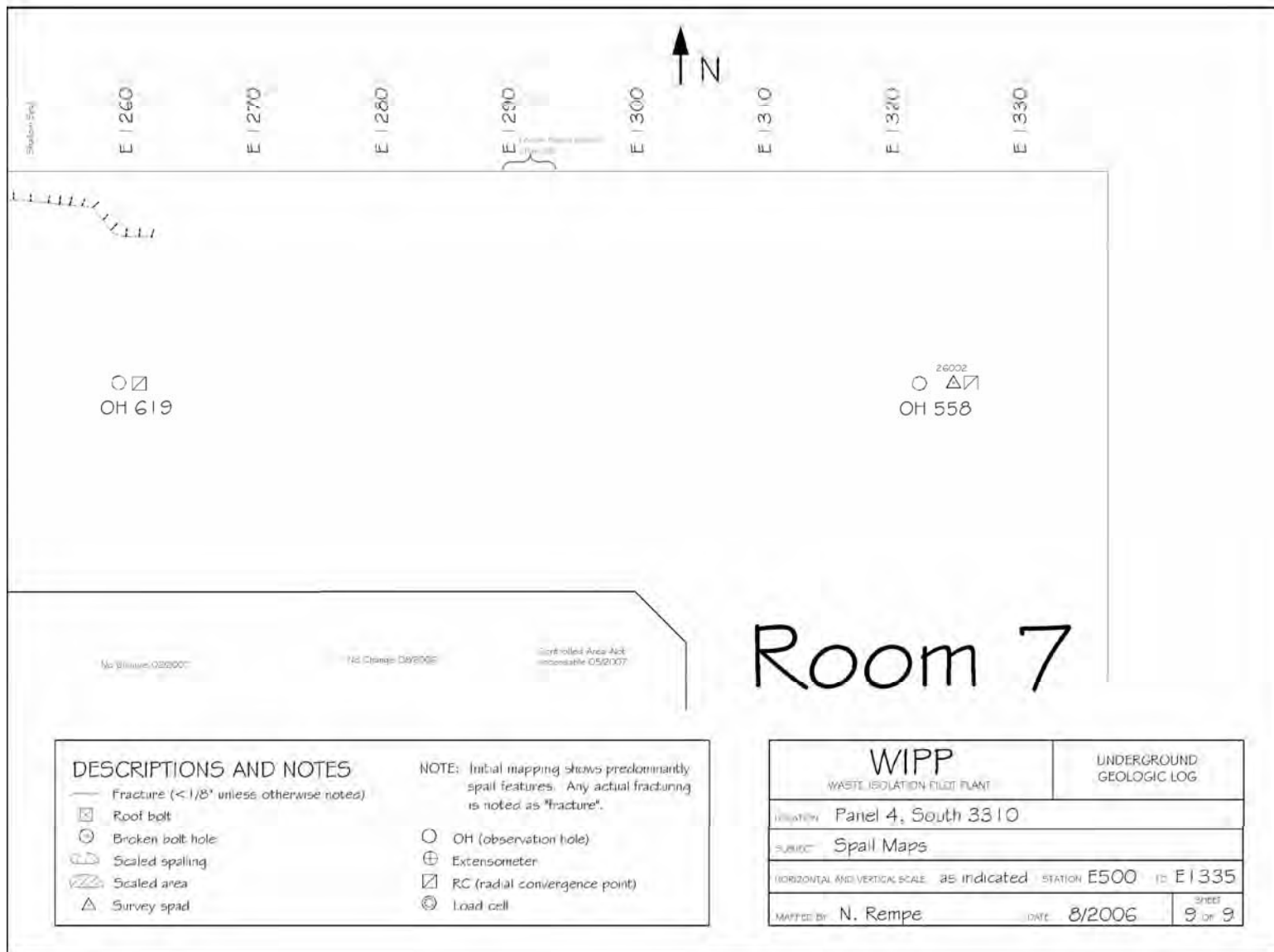
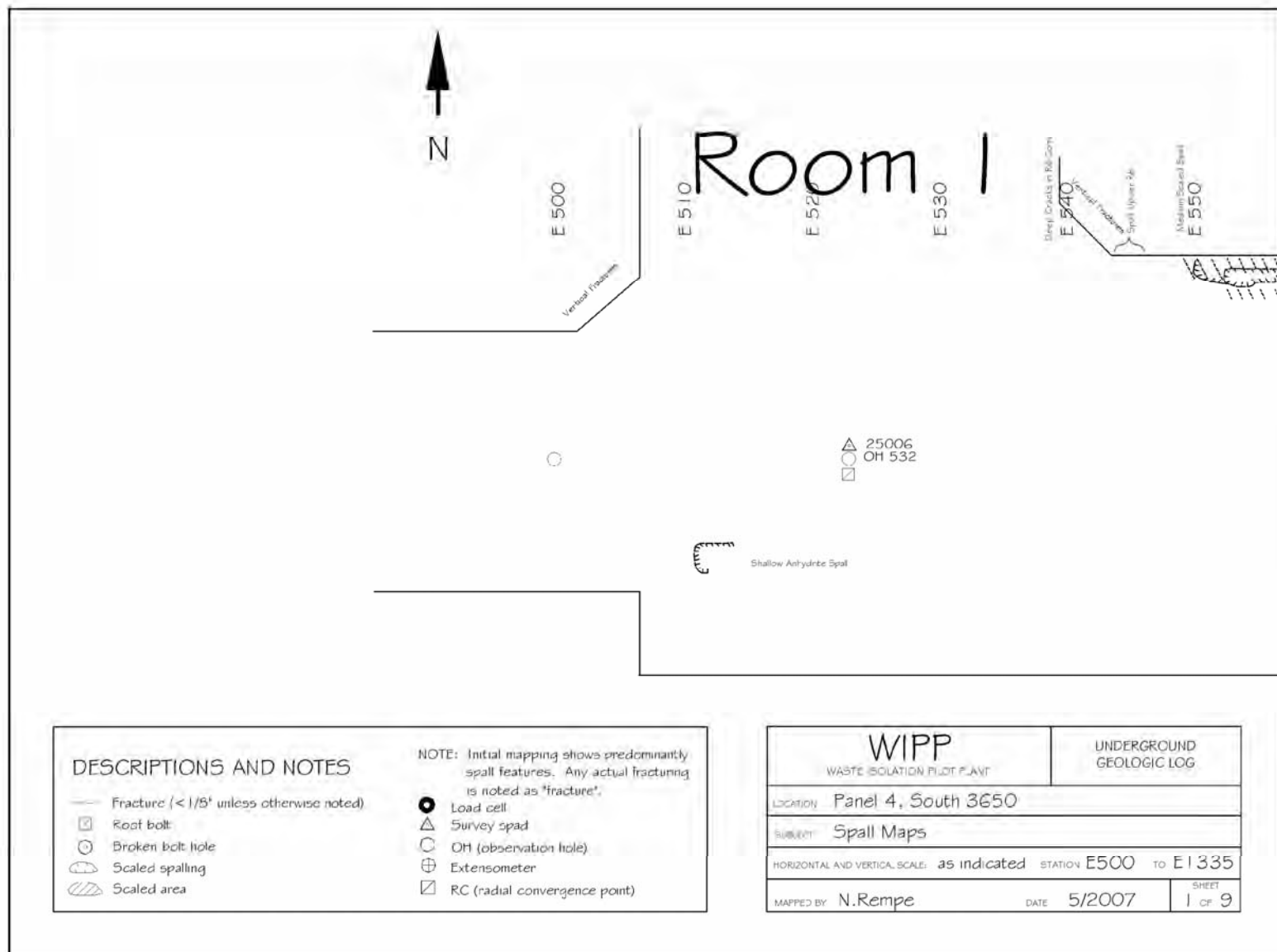


Figure 6-30  
 Panel 4 S3310, E500 – E1335 Roof Fractures (Sheet 9 of 9)



**Figure 6-31**  
Panel 4 S3650, E500 – E1335 Roof Fractures (Sheet 1 of 9)

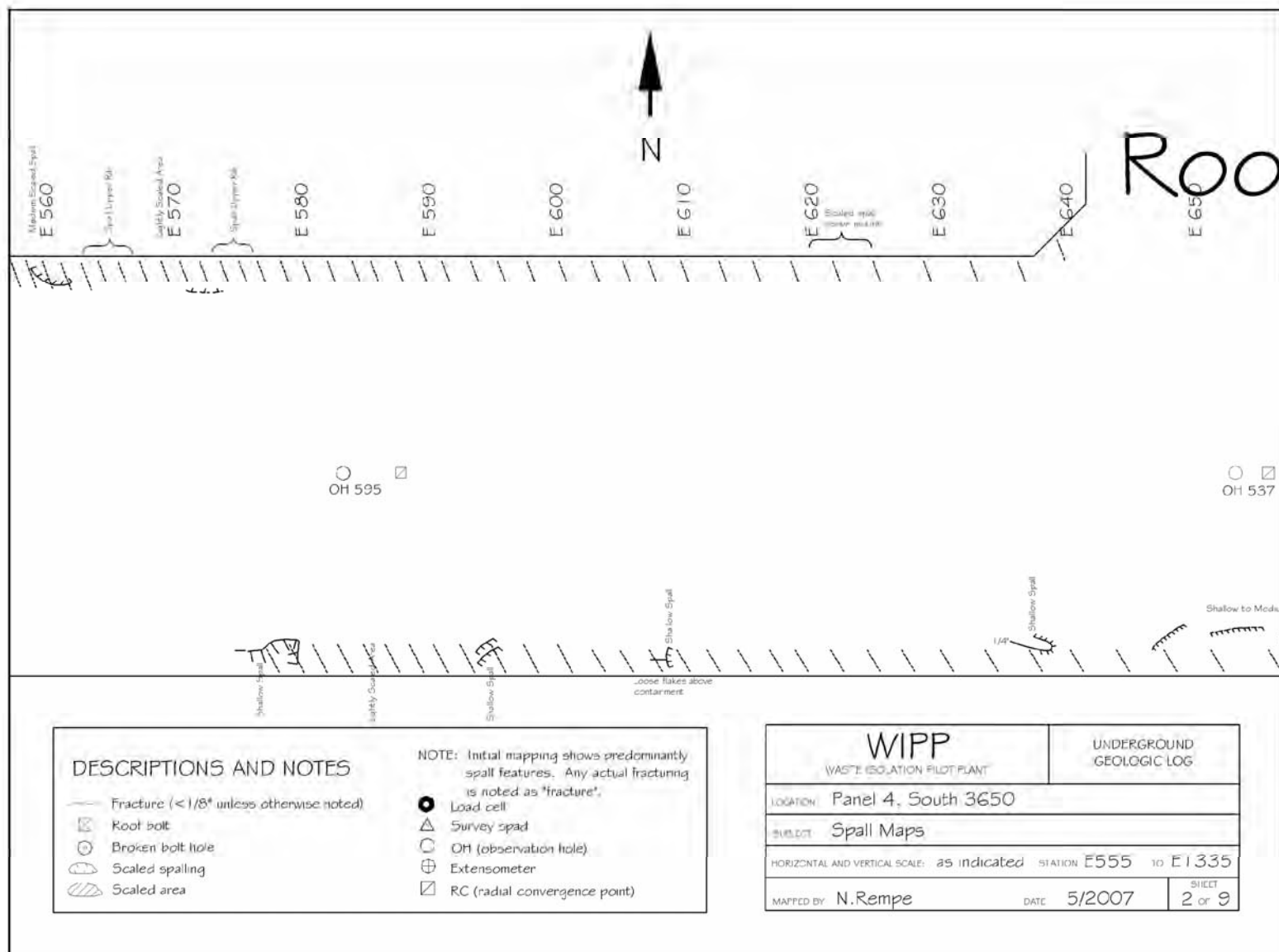


Figure 6-32  
 Panel 4 S3650, E500 – E1335 Roof Fractures (Sheet 2 of 9)

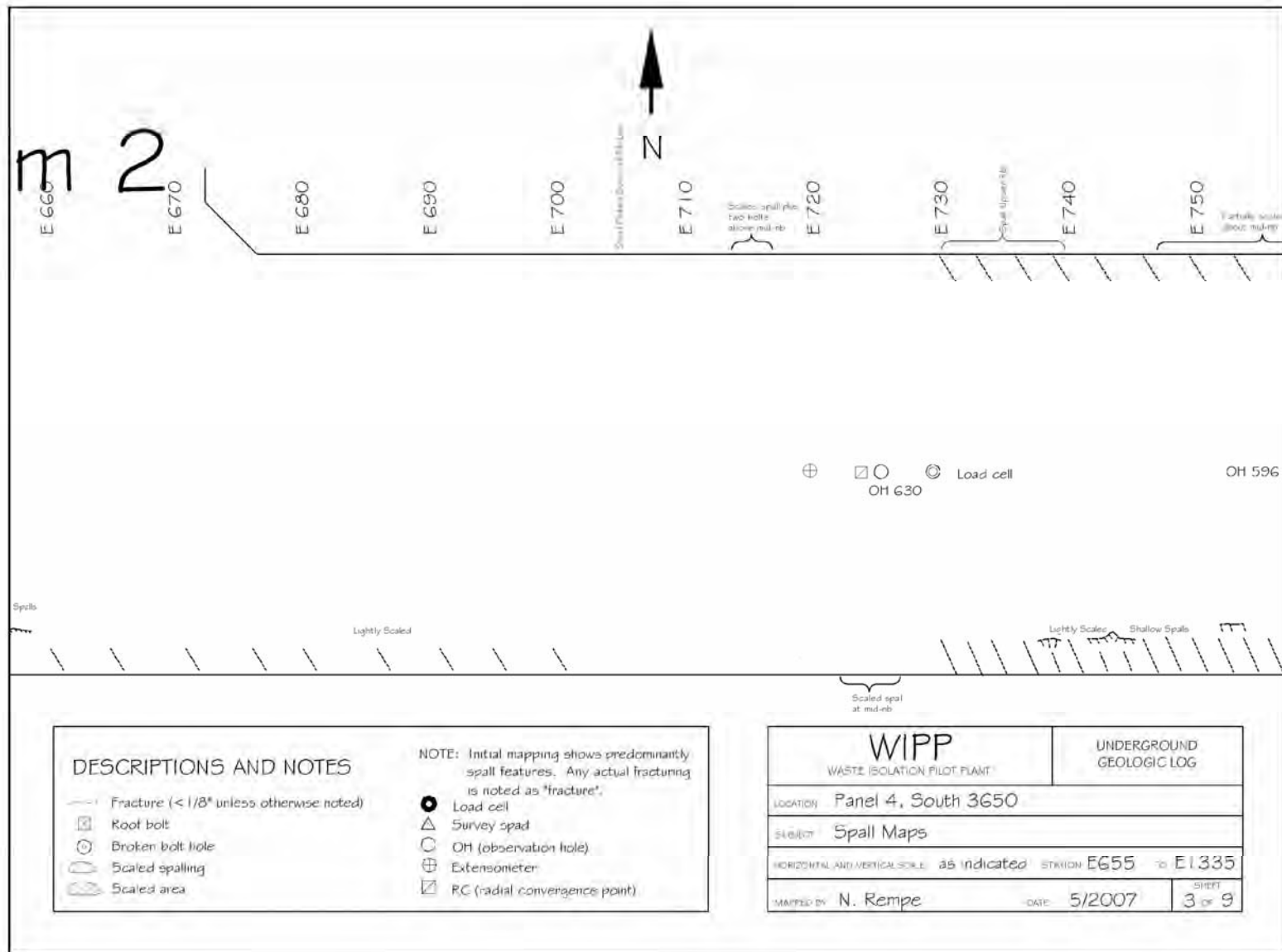
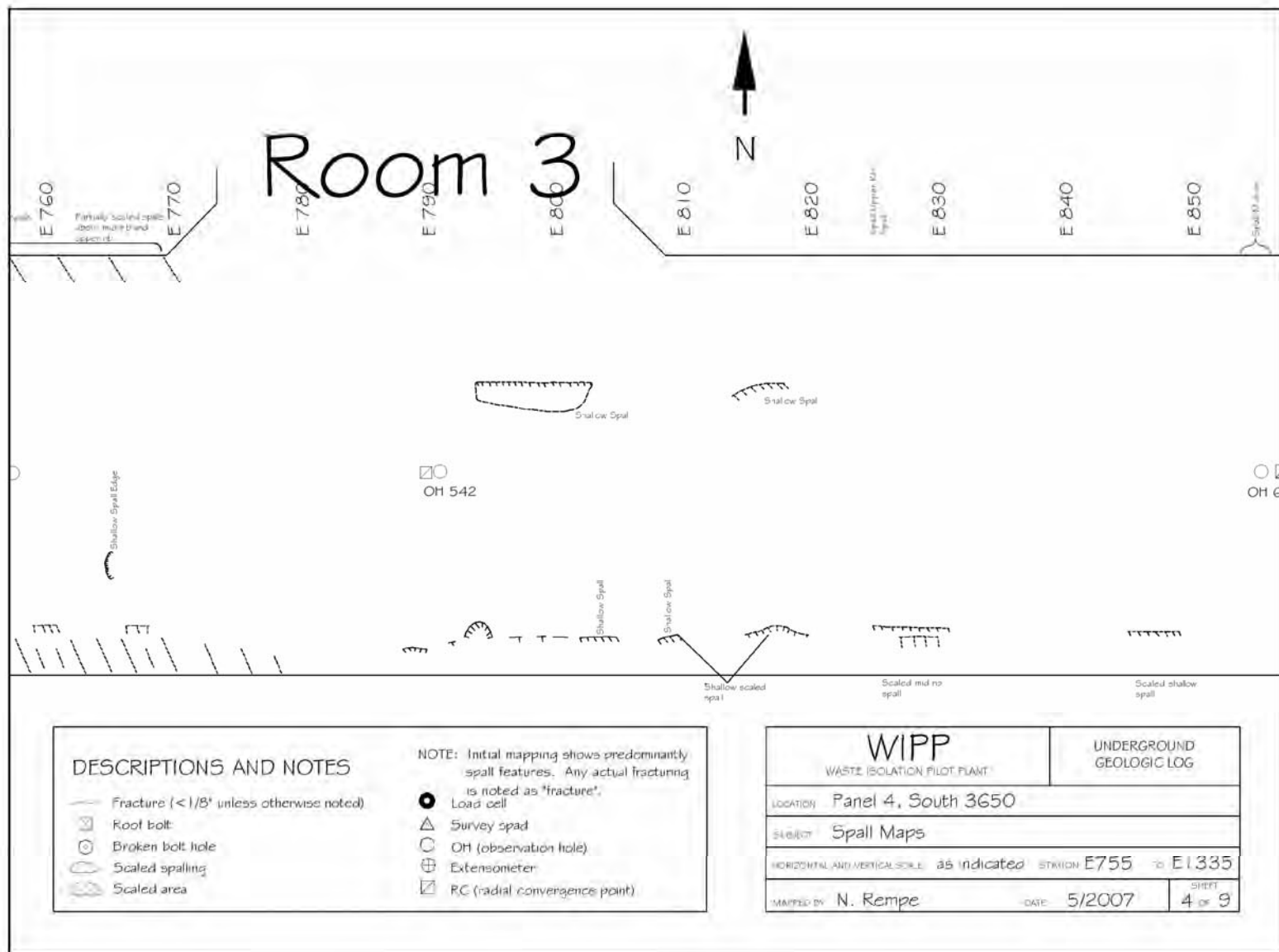
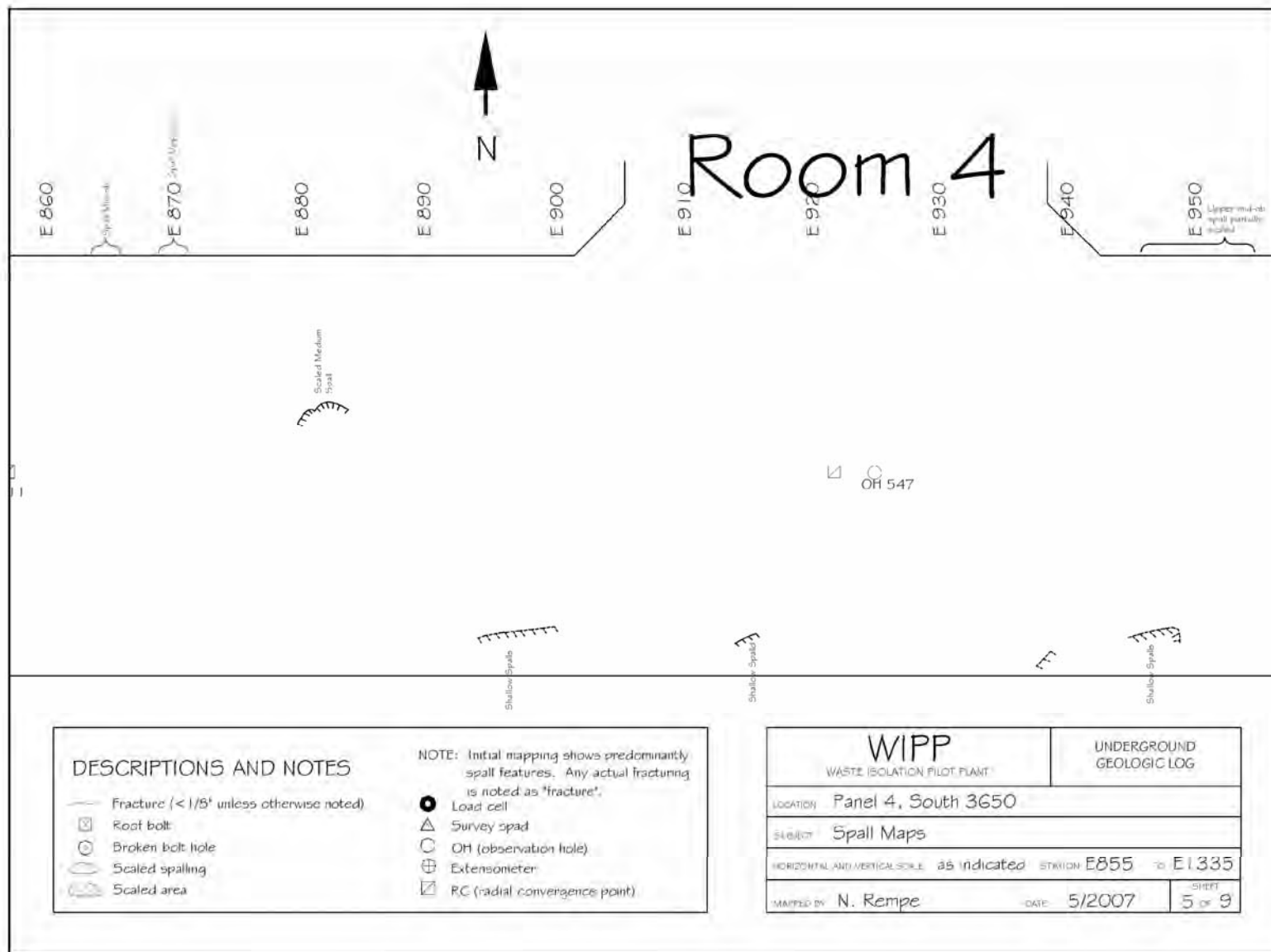


Figure 6-33  
Panel 4 S3650, E500 – E1335 Roof Fractures (Sheet 3 of 9)





**Figure 6-34**  
Panel 4 S3650, E500 – E1335 Roof Fractures (Sheet 4 of 9)



**Figure 6-35**  
Panel 4 S3650, E500 – E1335 Roof Fractures (Sheet 5 of 9)

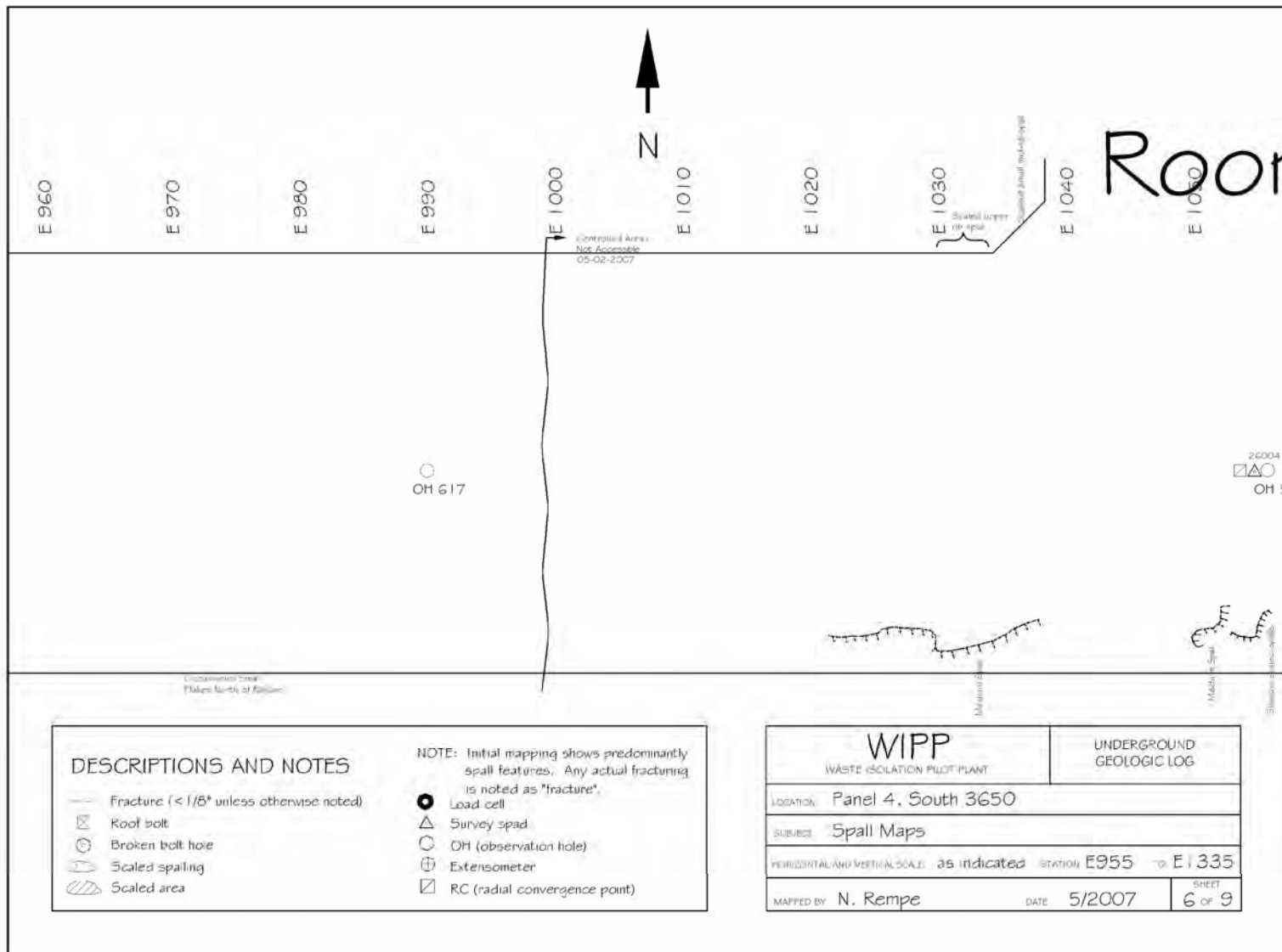


Figure 6-36  
Panel 4 S3650, E500 – E1335 Roof Fractures (Sheet 6 of 9)

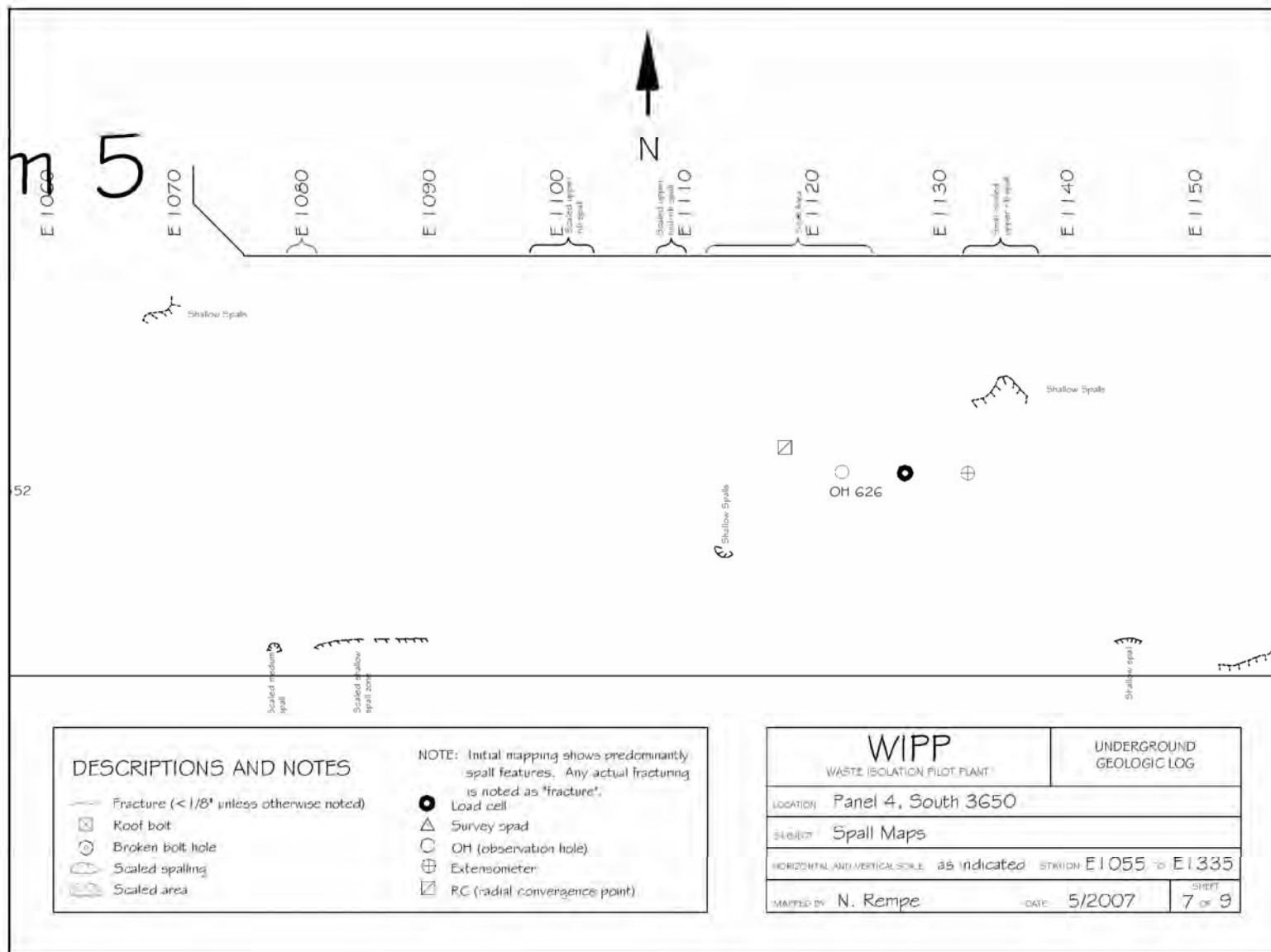


Figure 6-37  
Panel 4 S3650, E500 – E1335 Roof Fractures (Sheet 7 of 9)

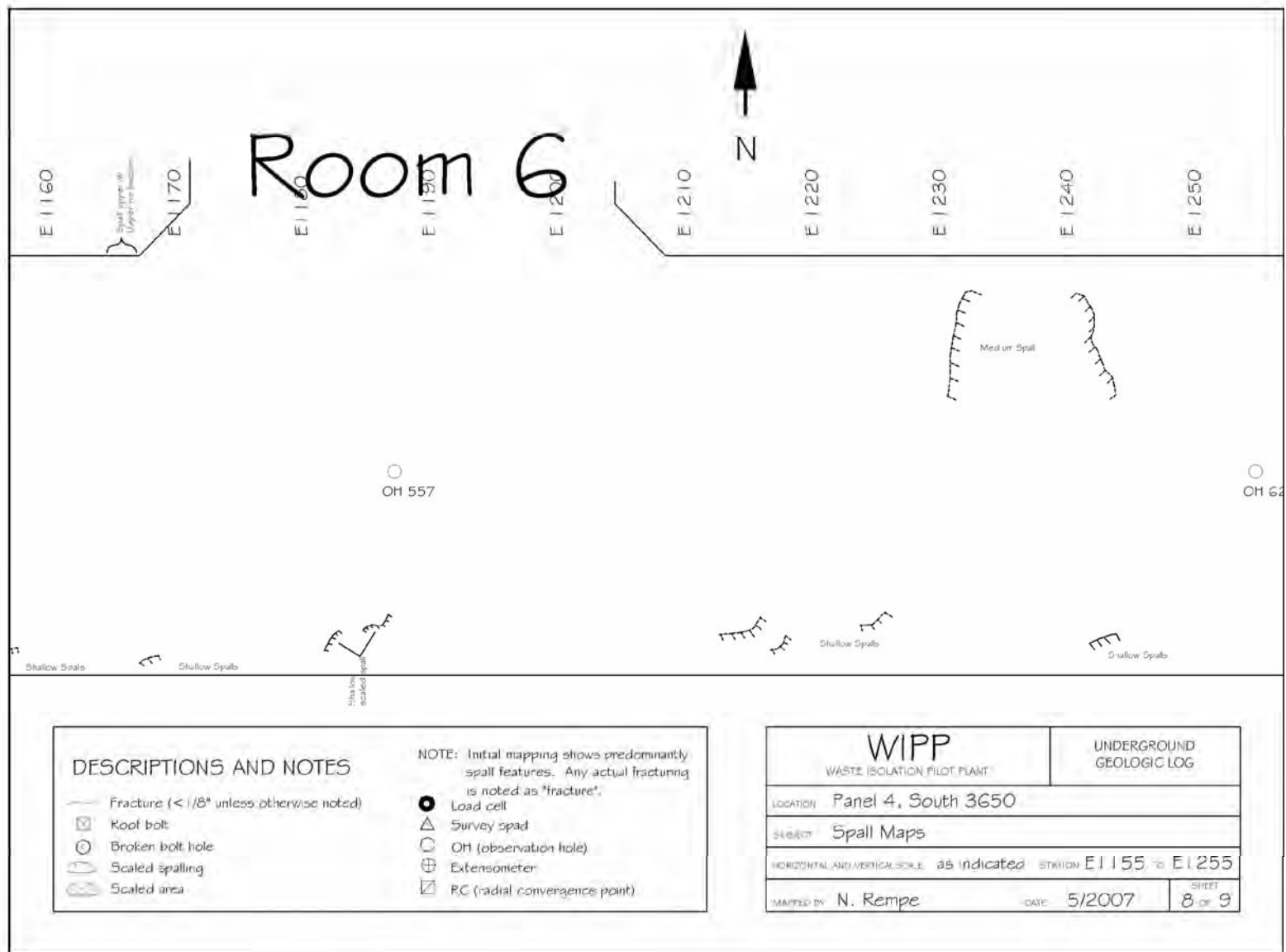


Figure 6-38  
Panel 4 S3650, E500 – E1335 Roof Fractures (Sheet 8 of 9)

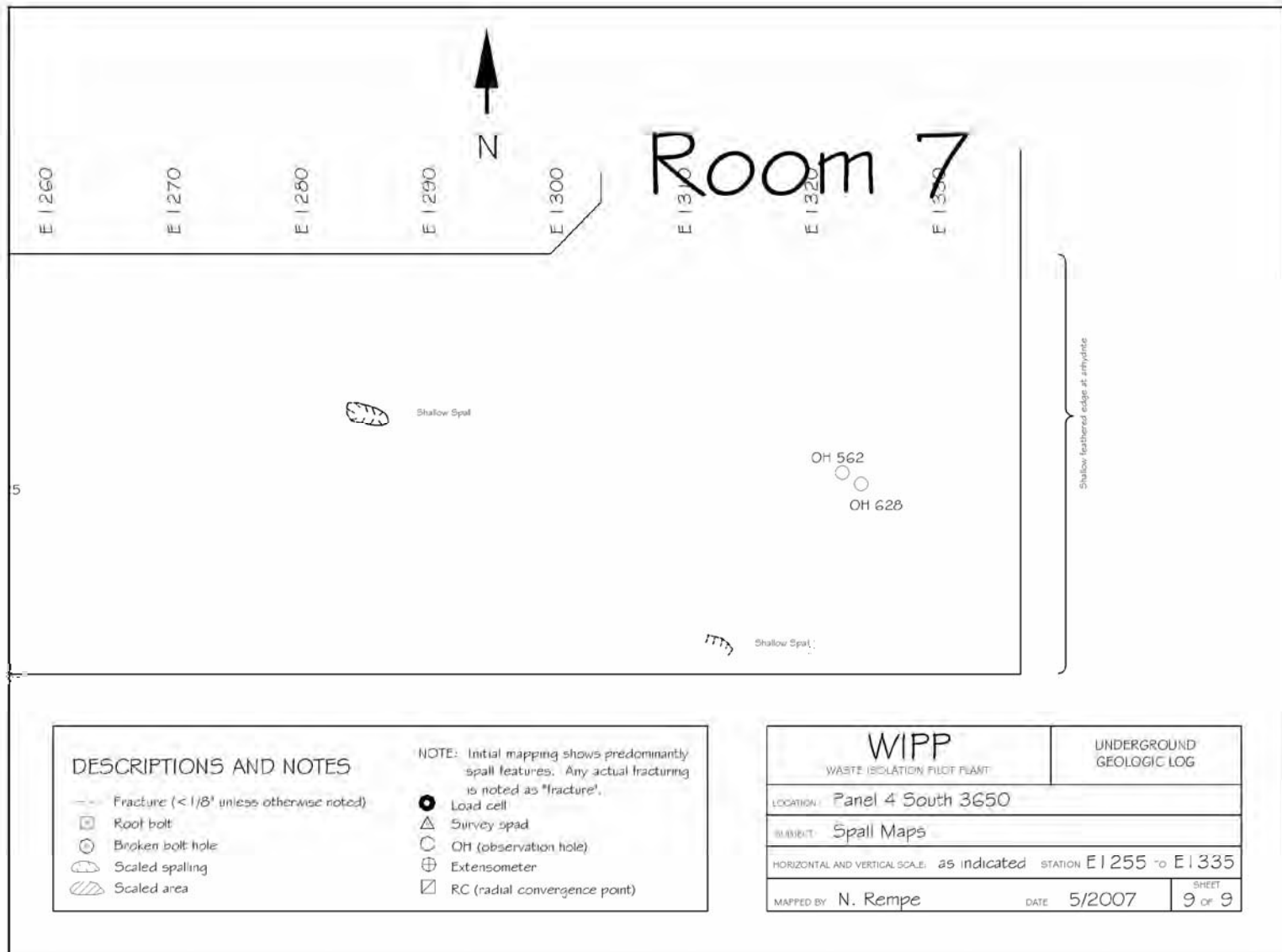


Figure 6-39  
Panel 4 S3650, E500 – E1335 Roof Fractures (Sheet 9 of 9)